

Handbook of Noise Measurement

by Arnold P.G. Peterson

NINTH EDITION

Copyright 1963, 1967, 1972, 1974, 1978, 1980 by GenRad, Inc.
Concord, Massachusetts U.S.A.

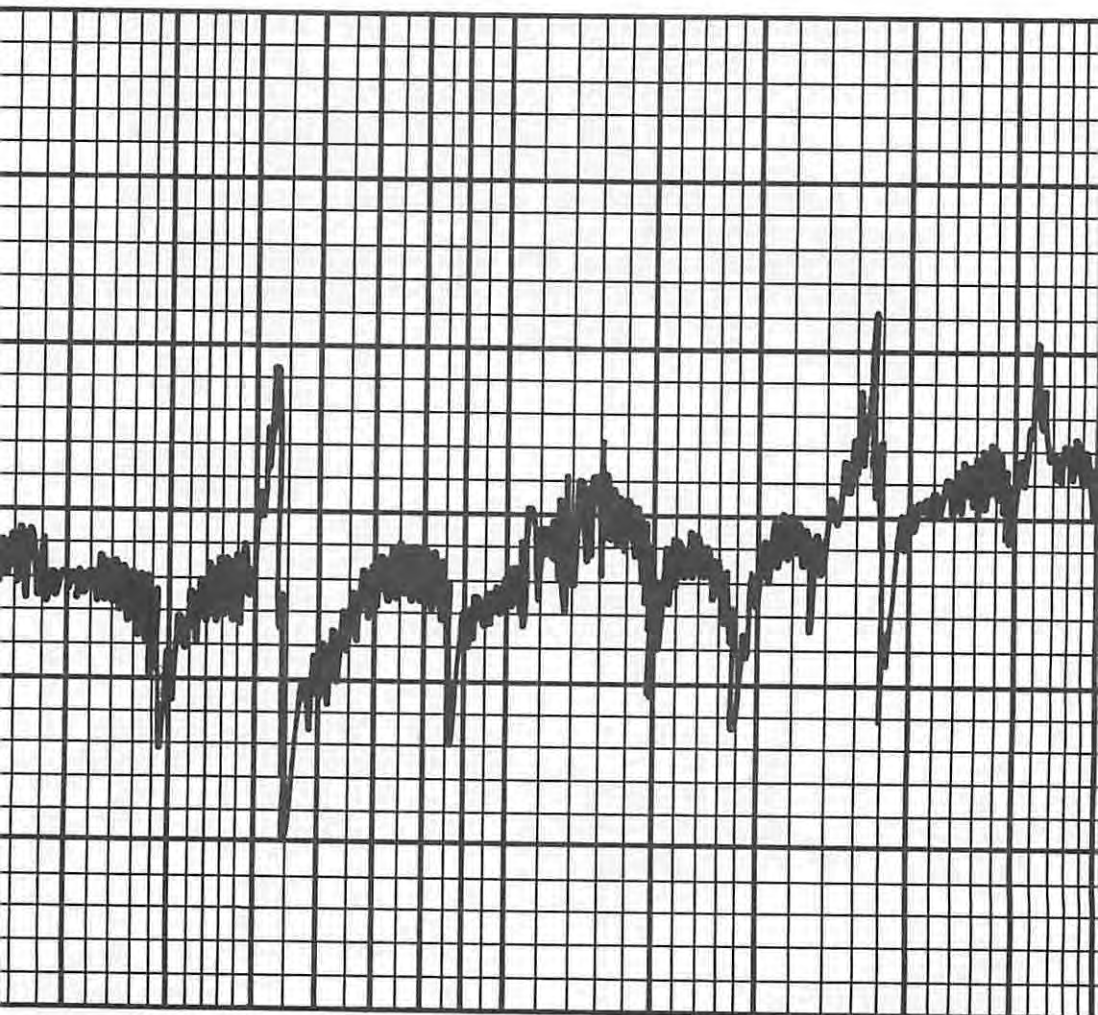

Preface

New instruments and new measures of noise have made necessary this latest revision.

Many of the chapters have been extensively revised, and much new material has been added to some chapters. In particular, comments from users showed the need for more details on microphones and more specific information on the relation of a spectrum to its source.

The extensive growth of community noise measurements has also led to additions in some of the chapters.

The help of our former colleague, Ervin Gross, who has retired, has been greatly missed. But Warren Kundert, David Allen, and Edward Rahaim have helped extensively in the preparation of this edition.

Arnold P.G. Peterson

Table of Contents

| | |
|---|-----|
| Chapter 1. Introduction | 1 |
| Chapter 2. Sound, Noise and Vibration | 3 |
| Chapter 3. Hearing Damage from Noise Exposure | 17 |
| Chapter 4. Other Effects of Noise | 25 |
| Chapter 5. Vibration and Its Effects | 75 |
| Chapter 6. Microphones, Preamplifiers, and Vibration Transducers | 83 |
| Chapter 7. Sound-Level Meters and Calibrators | 105 |
| Chapter 8. Analysis | 115 |
| Chapter 9. Analyzers (Spectrum Analyzers) | 151 |
| Chapter 10. Recorders and Other Instruments | 157 |
| Chapter 11. What Noise and Vibration Measurements Should be Made | 167 |
| Chapter 12. Techniques, Precautions, and Calibrations | 179 |
| Chapter 13. Source Measurements (Product Noise), Sound Fields, Sound Power. | 195 |
| Chapter 14. Community Noise Measurements— L_{eq} , L_{dn} , L-levels | 217 |
| Chapter 15. Vibration Measurement Techniques | 231 |
| Chapter 16. Noise and Vibration Control | 239 |
| Chapter 17. Case Histories | 273 |

Appendixes

| | |
|---|-----|
| I Decibel Conversion Tables | 275 |
| II Chart for Combining Levels of Uncorrelated Noise Signals | 281 |
| III Table for Converting Loudness to Loudness Level | 282 |
| IV Vibration and Conversion Charts | 283 |
| V Definitions | 285 |
| VI Words Commonly Used to Describe Sounds | 300 |
| VII Standards and Journals | 301 |
| VIII Catalog Section | 310 |

Index

Chapter 1

Introduction

During the past decade more and more people have become concerned with the problem of noise in everyday life. There is danger of permanent hearing loss when exposure to an intense sound field is long and protective measures are not taken. This is important to millions of workers, to most industrial corporations, labor unions, and insurance companies.

The noise problem near many airports has become so serious that many people have moved out of nearby areas that were once considered pleasant. The din of high-powered trucks, motorcycles, and “hot” cars annoys nearly everyone, and one cannot so readily move away from them as from the airport, because they are almost everywhere.

The increasingly large number of people living in apartments, and the relatively light construction of most modern dwellings, has accentuated the problems of sound isolation. In addition, some of the modern appliances, for example dishwashers, are noisy for relatively long periods, which can be very vexing, if it interferes with a favorite TV program.

Lack of proper sound isolation and acoustical treatment in the classroom may lead to excessive noise levels and reverberation, with resulting difficulties in communication between teacher and class. The school teacher’s job may become a nightmare because the design was inadequate or altered to save on the initial cost of the classroom.

High-power electronic amplifiers have brought deafening “music” within the reach of everyone, and many young people may eventually regret the hearing loss that is accelerated by frequent exposure to the extremely loud music they find stimulating.

Of all these problems, noise-induced hearing loss is the most serious. Those who are regularly exposed to excessive noise should have their hearing checked periodically, to determine if they are adequately protected. This approach is discussed in more detail in chapter 3. In addition, for this problem as well as the others mentioned, reduction of noise at its source is often essential. The further step of providing direct protection for the individual may also be needed.

Much can be done by work on noise sources to reduce the seriousness of these noise problems. It is not often so simple as turning down the volume control on the electronic amplifier. But good mufflers are available for trucks, motorcycles and automobiles; and household appliances can be made quieter by the use of proper treatment for vibrating surfaces, adequately sized pipes and smoother channels for water flow, vibration-isolation mounts, and mufflers. The engineering techniques for dealing with noise are developing rapidly, and every designer should be alert to using them.

In many instances, the quieter product can function as well as the noisier one, and the increased cost of reducing the noise may be minor. But the aircraft-noise problem is an example where the factors of safety, performance, and cost must all be considered in determining the relative benefits to the public of changes made to cut down the noise.

In any of these, sound-measuring instruments and systems can help to assess the nature of the problem, and they can help in determining what to do to subdue the troublesome noise.

The study of mechanical vibration is closely related to that of sound, because sound is produced by the transfer of mechanical vibration to air. Hence, the process of quieting a machine or device often includes a study of the vibrations involved.

Conversely, high-energy acoustical noise, such as generated by powerful jet or rocket engines, can produce vibrations that can weaken structural members of a vehicle or cause electronic components to fail.

Other important effects of vibration include: human discomfort and fatigue from excessive vibration of a vehicle, fatigue and rupture of structural members, and increased maintenance of machines, appliances, vehicles, and other devices.

Vibration, then, is a source not only of noise, annoyance, and discomfort, but often of danger as well. The present refinement of high-speed planes, ships, and automobiles could never have been achieved without thorough measurement and study of mechanical vibration.

The instruments used in sound and vibration measurement are mainly electronic. Furthermore, some of the concepts and techniques developed by electronics engineers and physicists for dealing with random or interfering signals (for which they have borrowed the term "noise") are now used in sound and vibration studies.

The purpose of this book is to help those who are faced, possibly for the first time, with the necessity of making noise measurements. It attempts to clarify the terminology and definitions used in these measurements, to describe the measuring instruments and their use, to aid the prospective user in selecting the proper equipment for the measurements he must make, and to show how these measurements can be interpreted to solve typical problems.

Although some may wish to read the chapters of this book in sequence, many will find it more convenient to consult the table of contents or the index to find the sections of immediate interest. They then can refer to the other sections of the book as they need further information. For example, if hearing conservation is of primary concern, Chapter 3 could be read first. Chapter 11 ("What Noise and Vibration Measurements Should be Made") could be consulted if a specific noise problem is at hand. The reader can then find further details on the instruments recommended (Chapters 6, 7 & 9) and on the techniques of use (Chapters 6, 7, 8, 11, 12, 13, 14, 15).

Some sections of this book are marked by a diamond to indicate that they might well be omitted during an initial reading, since they are highly specialized or very technical.

Chapter 2

Sound, Noise and Vibration

2.1 INTRODUCTION

When an object moves back and forth, it is said to vibrate. This vibration disturbs the air particles near the object and sets them vibrating, producing a variation in normal atmospheric pressure. The disturbance spreads and, when the pressure variations reach our ear drums, they too are set to vibrating. This vibration of our ear drums is translated by our complicated hearing mechanisms into the sensation we call "sound."

To put it in more general terms, sound in the physical sense is a vibration of particles in a gas, a liquid, or a solid. The measurement and control of airborne sound is the basic subject of this book. Because the chief sources of sounds in air are vibrations of solid objects, the measurement and control of vibration will also be discussed. Vibrations of and in solids often have important effects other than those classified as sound, and some of these will also be included.

We have mentioned that a sound disturbance spreads. The speed with which it spreads depends on the mass and on the elastic properties of the material. In air the speed is about 1100 feet/second (about 750 miles/hour) or about 340 meters/second; in sea water it is about 1490 meters/second. The speed of sound has been popularized in aerodynamic concepts of the sound barrier and the supersonic transport, and its effects are commonly observed in echoes and in the apparent delay between a flash of lightning and the accompanying thunder.

The variation in normal atmospheric pressure that is a part of a sound wave is characterized by the rate at which the variation occurs and the extent of the variation. Thus, the standard tone "A" occurs when the pressure changes through a complete cycle 440 times per second. The frequency of this tone is then said to be 440 hertz, or 440 cycles per second (abbreviated "Hz" and "c/s," respectively). "Hertz" and "cycles per second" are synonymous terms, but most standardizing agencies have adopted "hertz" as the preferred unit of frequency.

Many prefixes are used with the unit of frequency, but the one that is common in acoustics and vibrations is "kilo-," abbreviated "k," which stands for a factor of 1000. Thus, 8000 Hz or 8000 c/s becomes 8kHz or 8kc/s.

The extent of the variation in pressure is measured in terms of a unit called the "pascal." A pascal, abbreviated "Pa," is a newton per square meter (N/m²), and it is approximately one-one-hundred-thousandth of the normal atmospheric pressure (standard atmospheric pressure = 101,325 pascals). Actually, these units are not often mentioned in noise measurements. Results are stated in decibels.

2.2 THE DECIBEL — WHAT IS IT?

Although to many laymen the decibel (abbreviated "dB") is uniquely associated with noise measurements, it is a term borrowed from electrical-communication engineering, and it represents a relative quantity. When it is used to express noise level, a reference quantity is implied. Usually, this reference value is a sound pressure of 20 micropascals (abbreviated 20 μ Pa). For the present, the reference level can be referred to as "0 decibels," the starting point of the scale of noise levels. This starting point is about the level of the weakest sound that can be

heard by a person with very good hearing in an extremely quiet location. Other typical points on this scale of noise levels are shown in Figure 2-1. For example, the noise level in a large office usually is between 50 and 60 decibels. Among the very loud sounds are those produced by nearby airplanes, railroad trains, riveting machines, thunder, and so on, which are in the range near 100 decibels. These typical values should help the newcomer to develop a feeling for this term "decibel" as applied to sound level.

For some purposes it is not essential to know more about decibels than the above general statements. But when we need to modify or to manipulate the measured decibels, it is desirable to know more specifically what the term means. There is then less danger of misusing the measured values. From a strictly technical standpoint, the decibel is a logarithm of a ratio of two values of power, and equal changes in decibels represent equal ratios.

Although we shall use decibels for giving the results of power-level calculations, the decibel is most often used in acoustics for expressing the sound-pressure level and the sound level. These are extensions of the original use of the term, and all three expressions will be discussed in the following sections. First, however, it is worthwhile to notice that the above quantities include the word "level." Whenever level is included in the name of the quantity, it can be expected that the value of this level will be given in decibels or in some related term and that a reference power, pressure, or other quantity is stated or implied.

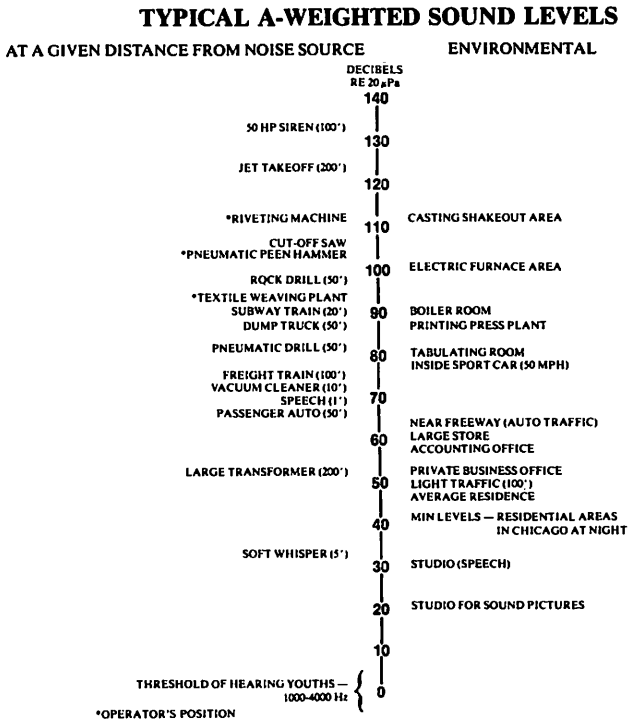

Figure 2-1. Typical A-weighted sound levels measured with a sound-level meter. These values are taken from the literature. Sound-level measurements give only part of the information usually necessary to handle noise problems, and are often supplemented by analysis of the noise spectra.

2.3 POWER LEVEL.

Because the range of acoustic powers that are of interest in noise measurements is about one-billion-billion to one ($10^{18}:1$), it is convenient to relate these powers on the decibel scale, which is logarithmic. The correspondingly smaller range of numerical values is easier to use and, at the same time, some calculations are simplified.

The decibel scale can be used for expressing the ratio between any two powers; and tables for converting from a power ratio to decibels and vice versa are given in Appendix I of this book. For example, if one power is four times another, the number of decibels is 6; if one power is 10,000 times another, the number is 40 decibels.

It is also convenient to express the power as a power level with respect to a reference power. Throughout this book the reference power will be 10^{-12} watt. Then the power level (L_w) is defined as

$$L_w = 10 \log \frac{W}{10^{-12}} \text{ dB re } 10^{-12} \text{ watt}$$

where W is the acoustic power in watts, the logarithm is to the base 10, and re means referred to. This power level is conveniently computed from

$$L_w = 10 \log W + 120$$

since 10^{-12} as a power ratio corresponds to -120 dB. The quantity $10 \log W$, which is the number of decibels corresponding to the numerical value of watts, can be readily obtained from the decibel tables in the Appendix. For example, 0.02 watt corresponds to a power level of

$$-17 + 120 = 103 \text{ dB.}$$

Some typical power levels for various acoustic sources are shown in Figure 2-2.

No instrument for directly measuring the power level of a source is available. Power levels can be computed from sound-pressure measurements, but the relation is not simple (see Chapter 13).

ACOUSTIC POWER

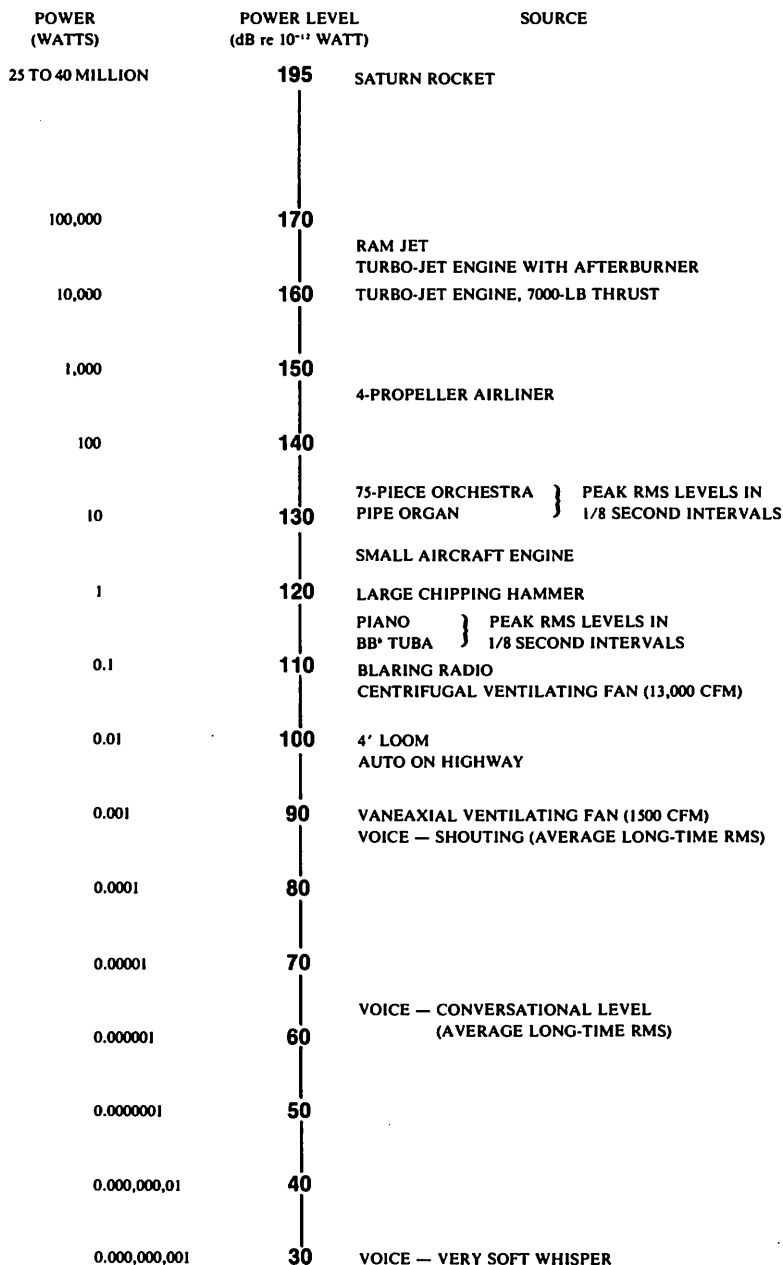

Figure 2-2. Typical power levels for various acoustic sources. These levels bear no simple relation to the sound levels of Figure 2-1.

A term called "power emission level" is being used to rate the noise power output of some products. The power emission level is based on measurements that are modified to include an A-weighted response. This response is described below under "Sound Level." The noise power emission level is one-tenth of the A-weighted sound power level. The unit is a bel (B).

2.4 SOUND-PRESSURE LEVEL.

It is also convenient to use the decibel scale to express the ratio between any two sound pressures; tables for converting from a pressure ratio to decibels and vice versa are given in the Appendix. Since sound pressure is usually proportional to the square root of the sound power, the sound-pressure ratio for a given number of decibels is the square root of the corresponding power ratio. For example, if one sound pressure is twice another, the number of decibels is 6; if one sound pressure is 100 times another, the number is 40 decibels.

The sound pressure can also be expressed as a sound-pressure level with respect to a reference sound pressure. For airborne sounds this reference sound pressure is generally 20 μ Pa. For some purposes a reference pressure of one microbar (0.1 Pa) has been used, but throughout this book the value of 20 μ Pa will always be used as the reference for sound-pressure level. Then the definition of sound-pressure level (L_p) is

$$L_p = 20 \log \frac{p}{.00002} \text{ dB re 20 micropascals}$$

where p is the root-mean-square sound pressure in pascals for the sound in question. For example, if the sound pressure is 1 Pa, then the corresponding sound-pressure ratio is

$$\frac{1}{.00002} \text{ or } 50000.$$

From the tables, we find that the pressure level is 94 dB re 20 μ Pa. If decibel tables are not available, the level can, of course, be determined by calculation on a calculator that includes the "log" function.

The instrument used to measure sound-pressure level consists of a microphone, attenuator, amplifier, and indicating device. This instrument must have an over-all response that is uniform ("flat") as a function of frequency, and the instrument is calibrated in decibels according to the above equation.

The position of the selector switch of the instrument for this measurement is often called "FLAT" or "20-kHz" to indicate the wide frequency range that is covered. The result of a measurement of this type is also called "over-all sound-pressure level."

2.5 SOUND LEVEL.

The apparent loudness that we attribute to sound varies not only with the sound pressure but also with the frequency (or pitch) of the sound. In addition, the way it varies with frequency depends on the sound pressure. If this effect is taken into account to some extent for pure tones, by "weighting" networks included in an instrument designed to measure sound-pressure level, then the instrument is called a sound-level meter. In order to assist in obtaining reasonable uniformity among different instruments of this type, the American National

Standards Institute (formerly, USA Standards Institute and American Standards Association), in collaboration with scientific and engineering societies, has established a standard to which sound-level meters should conform. The International Electrotechnical Commission (IEC) and many nations have established similar standards.

The current American National Standard Specification for Sound-Level Meters (ANSI S1.4-1971) requires that three alternate frequency-response characteristics be provided in instruments designed for general use (see Figure 2-3)*. These three responses are obtained by weighting networks designated as A, B, and C. Responses A, B, and C selectively discriminate against low and high frequencies in approximate accordance with certain equal-loudness contours, which will be described in a later section.

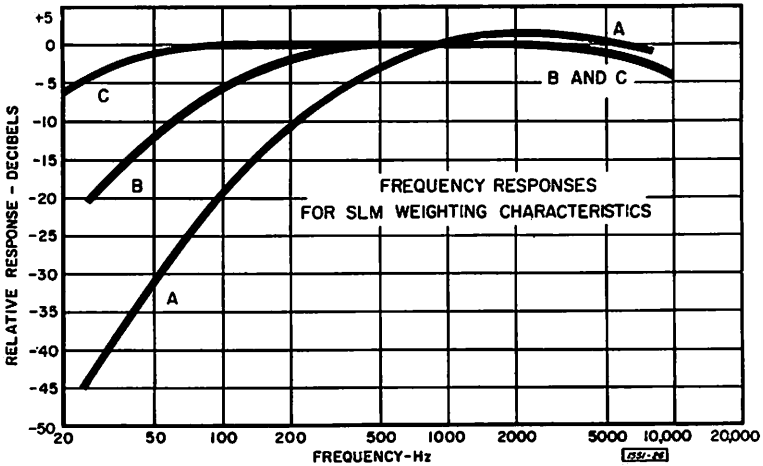

Figure 2-3. Frequency-response characteristics in the American National Standard Specification for Sound-Level Meters, ANSI-S1.4-1971.

Whenever one of these networks is used, the reading obtained should be described as in the following examples: the “A-weighted sound level is 45 dB” “sound level (A) = 45 dB,” or “SLA = 45 dB.” In a table, the abbreviated form “ L_A ” with the unit “dB” is suggested, or where exceptional compactness is necessary, “dB A,” where the space between dB and A denotes that the “A” is not part of the unit but is an abbreviation for “A-weighted level.” The form “dB(A)” is also used. The form “dBA” implies that a new unit has been introduced and is therefore not recommended. Note that when a weighting characteristic is used, the reading obtained is said to be the “sound level.”** Only when the over-all frequency response of the instrument is flat are sound-pressure levels measured. Since the reading obtained depends on the weighting characteristic used, the characteristic that was used must be specified or the recorded level may be useless. A common practice is to assume A-weighting if not otherwise specified.

*The current international standards and most national standards on sound-level meters specify these same three responses.

**It was customary, if a single sound-level reading was desired, to select the weighting position according to level, as follows: for levels below 55 dB, A weighting; for levels from 55 dB to 85 dB, B weighting; and for levels above 85 dB, C weighting. Now, however, the A-weighted sound level is the one most widely used regardless of level. See paragraph 4.21.

It is often recommended that readings on all noises be taken with *all three* weighting positions. The three readings provide some indication of the frequency distribution of the noise. If the level is essentially the same on all three networks, the sound probably predominates in frequencies above 600 Hz. If the level is greater on the C network than on the A and B networks by several decibels, much of the noise is probably below 600 Hz.

In the measurement of the noise produced by distribution and power transformers, the difference in readings of level with C-weighting and A-weighting networks ($L_C - L_A$) is frequently noted. (This difference in decibels is called the “harmonic index” in that application only.) It serves, as indicated above, to give some idea of the frequency distribution of the noise. This difference is also used in other noise-rating techniques in conjunction with the A-weighted sound level.

2.6 COMBINING DECIBELS.

A number of possible situations require the combining of several noise levels stated in decibels. For example, we may want to predict the effect of adding a noisy machine in an office where there is already a significant noise level, to correct a noise measurement for some existing background noise, to predict the combined noise level of several different noise sources, or to obtain a combined total of several levels in different frequency bands.

In none of these situations should the numbers of decibels be added directly. The method that is usually correct is to combine them on an energy basis. The procedure for doing this is to convert the numbers of decibels to relative powers, then add or subtract them, as the situation may require, and then convert back to the corresponding decibels. By this procedure it is easy to see that a noise level of 80 decibels combined with a noise level of 80 decibels yields 83 decibels and not 160 dB. A table showing the relation between power ratio and decibels appears in Appendix I. A chart for combining or subtracting different decibel levels is shown in Appendix II.

The single line chart of Figure 2-4 is particularly convenient for adding noise levels. For example, a noisy factory space has a present A-weighted level at a given location of 82 dB. Another machine is to be added 5 feet away. Assume it's known from measurements on the machine, that at that location in that space, it alone will produce an A-weighted level of about 78 dB. What will the over-all level be when it is added? The difference in levels is 4 dB. If this value is entered on the line chart, one finds that 1.5 dB should be added to the higher level to yield 83.5 dB as the resultant level.

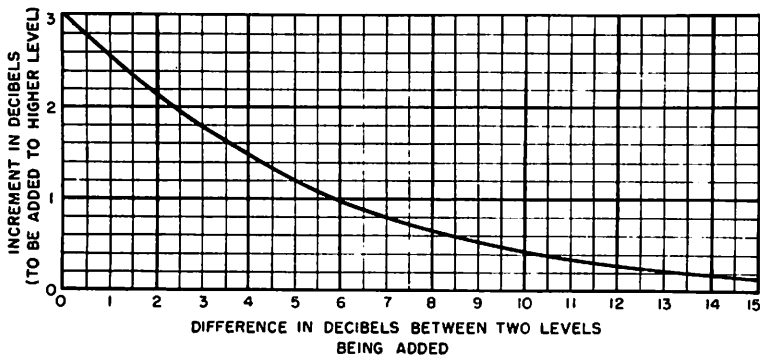

Figure 2-4. Chart for combining noise levels.

Calculators that include the “log” and “10^x” functions can easily be used for combining several noise levels. The basic formula for adding levels L₁, L₂, L₃, etc., to obtain the total level L_T is

$$L_T = 10 \log (10^{L_1/10} + 10^{L_2/10} + 10^{L_3/10} + \dots)$$

The procedure is as follows:

Use one-tenth of the first level to be added as “x” in the function “10^x.”

Add to this value the result obtained when one-tenth of the second level to be added is used as “x” in the function “10^x.”

Continue adding in these results until all the levels have been used.

Then take the “log” of the resulting sum and multiply by 10.

This procedure for combining levels is not always valid. When, for example, two or more power transformers are producing a humming noise, the level of the combined noise can vary markedly with the position of the observer. This situation is not the usual one but it should be kept in mind as a possibility. It can occur whenever two or more sources have noises that are dominated by coherent signals, for example, machinery running at synchronous speeds can have similar effects.

2.7 VIBRATION

Vibration is the term used to describe alternating motion of a body with respect to a reference point. The motion may be simple harmonic motion like that of a pendulum, or it may be complex like a ride in the “whip” at an amusement park. The motion may involve tiny air particles that produce sound when the rate of vibration is in the audible frequency range (20 to 20,000 Hz), or it may involve, wholly or in part, structures found in machinery, bridges, or aircraft. Usually the word vibration is used to describe motions of the latter types, and is classed as solid-borne, or mechanical, vibration.

Many important mechanical vibrations lie in the frequency range of 1 to 2,000 Hz (corresponding to rotational speeds of 60 to 120,000 rpm). In some specialized fields, however, both lower and higher frequencies are important. For example, in seismological work, vibration studies may extend down to a small fraction of a Hz, while in loudspeaker-cone design, vibrations up to 20,000 Hz must be studied.

2.7.1 Nature of Vibratory Motion. Vibration problems occur in so many devices and operations that a listing of these would be impractical. Rather, we shall give a classification on the basis of the vibratory motion, together with numerous examples of where that motion occurs, to show the practical application. The classes of vibratory motion that have been selected are given in Table 2-1. They are not mutually exclusive and, furthermore, most devices and operations involve more than one class of vibratory motion.

Table 2-1
NATURE OF VIBRATORY MOTION

| | | |
|---|---|--|
| <p>Torsional or twisting vibration Examples: Reciprocating devices Gasoline and diesel engines Valves Compressors Pumps Rotating devices Electric motors Fans Turbines Gears Turntables Pulleys Propellers</p> | <p>Flexural and plate-mode vibration Examples: Aircraft Circular saws Loudspeaker cones Sounding boards Ship hulls and decks Turbine blades Gears Bridges Floors Walls</p> | <p>Intermittent vibration (mechanical shock) Examples: Blasting Gun shots Earthquakes Drop forges Heels impacting floors Typewriters Ratchets Geneva mechanisms Stepping motors Autos Catapults Planers Shapers Chipping hammers Riveters Impact wrenches</p> |
| <p>Bending vibration Examples: Shafts in motors, engines String instruments Springs Belts Chains Tape in recorders Pipes Bridges Propellers Transmission lines Aircraft wings Reeds on reed instruments Rails Washing machines</p> | <p>Translational, axial, or rigid-body vibration Examples: Reciprocating devices Gasoline and diesel engines Compressors Air hammers Tamping machines Shakers Punch presses Autos Motors Devices on vibration mounts</p> | <p>Random and miscellaneous motions Examples: Combustion Ocean waves Tides Tumblers Turbulence Earthquakes Gas and fluid motion and their interaction with mechanisms</p> |
| | <p>Extensional and shear vibration Examples: Transformer hum Hum in electric motors and generators Moving tapes Belts Punch presses Tamping machines</p> | |

2.7.2 Vibration Terms. Vibration can be measured in terms of displacement, velocity, acceleration and jerk. The easiest measurement to understand is that of displacement, or the magnitude of motion of the body being studied. When the rate of motion (frequency of vibration) is low enough, the displacement can be measured directly with the dial-gauge micrometer. When the motion of the body is great enough, its displacement can be measured with the common scale.

In its simplest case, displacement may be considered as simple harmonic motion, like that of the bob of a pendulum, that is, a sinusoidal function having the form

$$x = A \sin \omega t \quad (1)$$

where A is a constant, ω is 2π times the frequency, and t is the time, as shown in Figure 2-5. The maximum peak-to-peak displacement, also called double amplitude, (a quantity indicated by a dial gauge) is $2A$, and the root-mean-square (rms) displacement is $A/\sqrt{2}$ ($= 0.707A$), while the "average double amplitude" (a term occasionally encountered) would be $4A/\pi$ ($= 1.272A$). Displacement measurements are significant in the study of deformation and bending of structures.

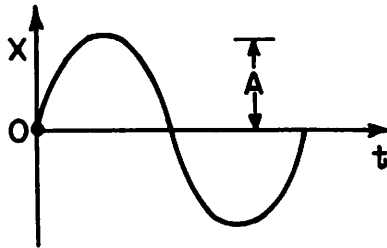

Figure 2-5. A simple sinusoidal function.

When a pure tone is propagated in air, the air particles oscillate about their normal position in a sinusoidal fashion. We could then think of sound in terms of the instantaneous particle displacement and specify its peak and rms value. But these displacements are so very small that they are very difficult to measure directly.

In many practical problems displacement is not the important property of the vibration. A vibrating mechanical part will radiate sound in much the same way as does a loudspeaker. In general, velocities of the radiating part (which corresponds to the cone of the loudspeaker) and the air next to it will be the same, and if the distance from the front of the part to the back is large compared with one-half the wavelength of the sound in air, the actual sound pressure in air will be proportional to the velocity of the vibration. The sound energy radiated by the vibrating surface is the product of the velocity squared and the resistive component of the air load. Under these conditions it is the velocity of the vibrating part and not its displacement that is of greater importance.

Velocity has also been shown by practical experience to be the best single criterion for use in preventive maintenance of rotating machinery. Peak-to-peak displacement has been widely used for this purpose, but then the amplitude selected as a desirable upper limit varies markedly with rotational speed.

Velocity is the time rate of change of displacement, so that for the sinusoidal vibration of equation (1) the velocity is:

$$v = \omega A \cos \omega t \quad (2)$$

Thus velocity is proportional to displacement and to frequency of vibration.

The analogy cited above covers the case where a loudspeaker cone or baffle is large compared with the wavelength of the sound involved. In most machines this relation does not hold, since relatively small parts are vibrating at relatively low frequencies. This situation may be compared to a small loudspeaker without a baffle. At low frequencies the air may be pumped back and forth from one side of the cone to the other with a high velocity, but without building up much of a pressure or radiating much sound energy because of the very low air load, which has a reactive mechanical impedance. Under these conditions an acceleration measurement provides a better measure of the amount of noise radiated than does a velocity measurement.

In many cases of mechanical vibration, and especially where mechanical failure is a consideration, the actual forces set up in the vibrating parts are important factors. The acceleration of a given mass is proportional to the applied force, and a reacting force equal but opposite in direction results. Members of a vibrating structure, therefore, exert forces on the total structure that are a function of the masses and the accelerations of the vibrating parts. For this reason, acceleration measurements are important when vibrations are severe enough to cause actual mechanical failure.

Acceleration is the time rate of change of velocity, so that for a sinusoidal vibration,

$$a = \omega^2 A \sin \omega t \quad (3)$$

It is proportional to the displacement and to the square of the frequency or the velocity and the frequency.

Jerk is the time rate of change of acceleration. At low frequencies this change is related to riding comfort of autos and elevators and to bodily injury. It is also important for determining load tiedown in planes, trains, and trucks.

2.7.3 Acceleration and Velocity Level. Some use is now being made of "acceleration level" and "velocity level," which, as the names imply, express the acceleration and velocity in decibels with respect to a reference acceleration and velocity. The reference values of 10^{-4} m/s (10^{-6} cm/s) for velocity and 10^{-3} m/s² (10^{-3} cm/s²) for acceleration are now used, although other references have been proposed.

2.7.4 Nonsinusoidal Vibrations. Equations (1), (2), and (3) represent only sinusoidal vibrations but, as with other complex waves, complex periodic vibrations can also be represented by a combination of sinusoidal vibrations often called a Fourier series. The simple equations may, therefore, be expanded to include as many terms as desirable in order to express any particular type of vibration. For a given sinusoidal displacement, velocity is proportional to frequency and acceleration is proportional to the square of the frequency, so that the higher-frequency components in a vibration are progressively more important in velocity and acceleration measurements than in displacement readings.

2.8 SUMMARY.

2.8.1 Sound. Reference quantities (ANSI S1.8-1969) and relations presented in this chapter included the following:

Reference sound pressure: $20 \mu\text{Pa}$ *

Reference power: 10^{-12} watt.**

$$\text{Power level } L_w = 10 \log \frac{W}{10^{-12}} \text{ dB re } 10^{-12} \text{ watt.}$$

where W is the acoustic power in watts.

$$\text{Sound pressure level: } L_p = 20 \log \frac{p}{.00002} \text{ dB re } 20 \mu\text{Pa}$$

where p is the root-mean-square sound pressure in Pa.

(Logarithms are taken to the base 10 in both L_w and L_p calculations.)

Important concepts that aid in interpreting noise measurement results can be summarized as follows:

To measure sound level, use a sound-level meter with one or more of its frequency-response weightings (A, B, and C).

To measure sound-pressure level, use a sound-level meter with the controls set for as uniform a frequency response as possible.

Decibels are usually combined on an energy basis, not added directly.

Speed of sound in air:

at 0°C is 1087 ft/s or 331.4 m/s

at 20°C is 1127 ft/s or 343.4 m/s

| Pressure | Pressure Level re $20 \mu\text{Pa}$ |
|--------------------------|--|
| 1 Pa | 94 dB |
| 1 microbar | 74 dB |
| 1 pound/ft. ² | 127.6 dB |
| 1 pound/in. ² | 170.8 dB |
| 1 atmosphere | 194.1 dB |

NOTE: The reference pressure and the reference power have been selected independently because they are not uniquely related.

*At one time the reference for a sound-level meter was taken as 10^{-12} watt/square meter. For most practical purposes, this reference is equivalent to the presently used pressure. This earlier reference value is *not* a reference for power, since it is power divided by an area. The pressure $20 \mu\text{Pa}$ is also expressed as 2×10^{-3} newton/square meter, 0.0002 microbar, or 0.0002 dyne/cm².

**A reference power of 10^{-13} watt has also been used in the USA and in very early editions of this handbook, but the reference power of 10^{-12} watt is preferred (ANSI S1.8-1969).

2.8.2 Vibration. Displacement is magnitude of the motion.

Velocity is the time rate of change of displacement.

Acceleration is the time rate of change of velocity.

Jerk is the time rate of change of acceleration.

Reference quantities:

Velocity: 10^{-8} meters/second (10^{-6} cm/s)

Acceleration: 10^{-3} meters/second/second (10^{-3} cm/s²)*

g = acceleration of gravity

*This reference is approximately one millionth of the gravitational acceleration ($\approx 1\mu g$)

REFERENCES

Standards

ANSI S1.1-1960, Acoustical Terminology.

ANSI S1.8-1969, Preferred Reference Quantities for Acoustical Levels.

ANSI S1.4-1971, Sound-Level Meters.

ANSI S1.13-1971, Methods for the Measurement of Sound Pressure Levels.

ANSI S1.23-1971, Designation of Sound Power Emitted by Machinery and Equipment
IEC/651(1979), Sound Level Meters

Other

L.L. Beranek (1949), *Acoustic Measurements*, John Wiley & Sons, Inc., New York.

L.L. Beranek (1954), *Acoustics*, McGraw-Hill Book Company, Inc., New York.

L.L. Beranek, ed. (1971), *Noise and Vibration Control*, McGraw-Hill Book Company, Inc., New York.

R.D. Berendt, E.L.R. Corliss, and M.S. Ojalvo (1976), *Quieting: A Practical Guide to Noise Control*, National Bureau of Standards Handbook 119, Supt. of Documents, US Govt. Printing Office, Washington, DC 20402.

R.E.D. Bishop (1965), *Vibration*, Cambridge University Press, Cambridge, England.

M.P. Blake and W.S. Mitchell, ed. (1972), *Vibration and Acoustics Measurement Handbook*, Spartan Books, N.Y.

C.E. Crede (1951), *Vibration and Shock Isolation*, John Wiley & Sons, Inc., New York.

J.P. Den Hartog (1968), *Mechanical Vibrations*, fourth edition, McGraw-Hill Book Company Inc., New York.

C.M. Harris, ed. (1979), *Handbook of Noise Control*, second edition, McGraw-Hill Book Company, Inc., New York.

C.M. Harris and C.E. Crede, ed. (1976), *Shock and Vibration Handbook*, second edition, McGraw-Hill Book Company, Inc., New York.

L.E. Kinsler and A.R. Frey (1962), *Fundamentals of Acoustics*, John Wiley & Sons, Inc., New York.

D.M. Lipscomb and A.C. Taylor, Jr., eds. (1978), *Noise Control: Handbook of Principles and Practices*, Van Nostrand Reinhold, New York.

E.B. Magrab (1975), *Environmental Noise Control*, John Wiley, New York.

D.N. May (1970), *Handbook of Noise Assessment*, Van Nostrand Reinhold, New York.

C.T. Morrow (1963), *Shock and Vibration Engineering*, John Wiley & Sons, Inc., New York.

P.M. Morse and K.U. Ingard (1968), *Theoretical Acoustics*, McGraw-Hill Book Company, Inc., New York. (A graduate text.)

H.F. Olson (1957), *Acoustical Engineering*, D. Van Nostrand Company, Inc., New York, 3rd Edition.

J.R. Pierce and E.E. David, Jr., (1958), *Man's World of Sound*, Doubleday & Company, Inc., Garden City, New York.

R.H. Randall (1951), *An Introduction to Acoustics*, Addison-Wesley Press, Cambridge, Mass.

- V. Salmon, J.S. Mills, and A.C. Petersen (1975), *Industrial Noise Control Manual*, National Institute for Occupational Safety and Health, Supt. of Documents, US Govt. Printing Office, Washington, DC 20402.
- R.W.B. Stephens and A.E. Bate (1966), *Acoustics and Vibrational Physics*, Arnold, London, St. Martin's Press, New York, 2nd Edition.
- G.W. Swenson, Jr. (1953), *Principles of Modern Acoustics*, D. Van Nostrand Company, Inc., New York.
- G.W. Van Santen (1953), *Mechanical Vibration*, Elsevier, Houston.
- W. Wilson (1959), *Vibration Engineering*, Charles Griffin, London.
- L.F. Yerges (1978), *Sound, Noise and Vibration Control*, Second Edition, Van Nostrand-Reinhold Company, New York.
- R.W. Young (1955), "A Brief Guide to Noise Measurement and Analysis," Research and Development Report 609, 16 May 1955, US Navy Electronics Laboratory, PB118036.

Chapter 3

Hearing Damage from Noise Exposure

3.1 INTRODUCTION

The most serious possible effect of noise is the damage it can cause to hearing, but this effect is not readily appreciated because the damage to hearing is progressive. When noise exposure is at a hazardous level, the effect is usually a gradual and irreversible deterioration in hearing over a period of many years. The gradualness of the effect was pointed out many years ago. Fosbroke in 1831 wrote: "The blacksmiths' deafness is a consequence of their employment; it creeps on them gradually, in general at about forty or fifty years of age."

Most people also do not recognize how serious a handicap deafness can be. Many can be helped by the use of hearing aids, but even the best aids are not as effective in correcting hearing loss as eyeglasses are in correcting many visual defects. The limited effectiveness is not necessarily a result of the characteristics of aids but is inherent in the behavior of the damaged hearing mechanism.

For many who have serious hearing losses the handicap leads to significant changes in attitude and behavior as well as to partial or almost complete social isolation. For example, here is a report about a maintenance welder, who is 60.

"... he has lost nearly all the hearing in one ear and about one-third of it in the other. He wears a hearing aid on his spectacles.

"'It's just half a life, that's what it is,' he says bitterly. 'I used to belong to several clubs. But I had to drop out. I couldn't hear what was going on.'"*

The seriousness of hearing damage from excessive noise exposure needs to be understood by workers, safety directors, and managers. It is particularly important that young people appreciate these effects, or else their bravado may lead them to accept high sound levels at work and in their recreation with serious effects in later life.

3.2 THE HUMAN HEARING MECHANISM

3.2.1 Anatomy. The hearing mechanism is conveniently separated into a number of parts. (Davis and Silverman, 1978) The external part, called the pinna, which leads into the tubular ear canal is obvious. The ear canal conducts the airborne sound to the ear drum (also called the "tympanic membrane"). All these parts are generally familiar, and the eardrum is usually considered as separating the "outer ear" from the "middle ear."

The air-borne sound pressure is translated into mechanical motion by the eardrum. This mechanical motion is transmitted through a chain of small bones, called the *ossicular chain*, to the *oval window*. The oval window acts as a piston to generate pressure waves in a fluid in the inner ear. The motion that results in the inner ear produces nerve impulses by means of so-called hair cells. These nerve impulses go through the eighth nerve to the brain, where the impulses are decoded into the sensation of sound.

**New York Times*, May 2, 1976.

3.2.2 Effects of Noise. The path described above is first, air-borne sound, then mechanical motion, followed by translation into nerve impulses. Interruptions in this path or damage to any part can affect hearing. Noise-induced damage is usually restricted to the translation into nerve impulses. The hair-cell structure is injured by excessive noise exposure. A short, intense blast, however, can damage the ear drum or the rest of the mechanical chain. But this mechanical damage can often be repaired, or, if it is minor, it may heal by itself.

3.3 NOISE-INDUCED HEARING LOSS

Studies over many years have shown that in general:

- 1) Hearing damage from exposure to excessive noise is a cumulative process; both level and exposure time are important factors.
- 2) At a given level, low-frequency noise tends to be less damaging than noise in the mid-frequency range. This effect has led to the general use of A-weighted sound levels for assessing noise.
- 3) Individuals are not all equally susceptible to noise-induced hearing loss.
- 4) The hearing loss that results from noise tends to be most pronounced near 4000 Hz, but it spreads over the frequency range with increased exposure time and level.

Two types of hearing loss from noise exposure are recognized, temporary and permanent. Immediately after exposure to noise at a level of 100 dB, say, there is a marked increase in the minimum level that one can hear (threshold) compared to that observed before exposure. If no further exposure to high level noise occurs, there is a gradual recovery of hearing ability. But repeated exposures over extended periods will lead to incomplete recovery and some permanent hearing loss. This permanent hearing loss (permanent threshold shift, PTS) depends on noise level and the pattern of exposure and recovery time. Since the work-exposure period is commonly 8 hours during the day, and the noise encountered outside of working hours is commonly below the damaging level, such a pattern of exposure is often assumed in rating workday noise.

During the workday, coffee breaks and lunch interrupt the noise exposure, and these periods for recovery are important in rating the exposure. Frequent and lengthy interruptions are regarded as helpful in reducing the possible permanent hearing loss from noise exposure.

Almost every expert in the field would agree that exposure to noise at an A-weighted sound level of 70 dB or less is not likely to cause significant hearing damage. Most of them would find a limit of an A-weighted 85 dB level as acceptable. If there were no serious added cost from achieving these levels, there would be little problem in selecting a maximum allowable limit. But it is clear that it can be very expensive for many industries to reduce the noise level to an A-weighted level of even 85 dB. It is necessary therefore to look at the noise-induced hearing loss problem very carefully.

As a practical compromise a limit of 90 dB(A) for 8-hours exposure every working day has been in effect in the USA for some years. It is recognized that this exposure over a long period will lead to measurable hearing loss in some susceptible people, and an 85 dB(A) limit would be more protective.

If the duration of exposure is less than 8 hours per day, somewhat higher levels can be tolerated. The relation that has been used in the USA allows 5 dB increase in level for a reduction of 2 to 1 in exposure time. This relation is often called a “5

dB exchange rate.** In other countries, only a 3 dB allowance or exchange rate is used. In actual practice this relation is made a continuous function up to a limit of 115 dB(A), and exposures at different levels are summed according to the duration of exposure to yield a total exposure to compare with 90 dB(A) for 8 hours.

3.4 ASSESSMENT OF NOISE

A single measurement of sound level is obviously not adequate for rating noise exposure for possible hearing damage. Instead special integrating sound-level meters are preferred instruments for this task. They are often called *noise dosimeters*.



Figure 3-1. The GR 1954 Noise Dosimeter. The monitor on the left can be clipped in a shirt pocket or on a belt. The indicator on the right is used to read out the accumulated noise dose at the end of the measurement period.

The GR 1954 Personal Noise Dosimeter, shown in Figure 3-1, includes a small microphone that is connected to an electronic monitor by means of a connecting cable. This small microphone can be worn at the ear (even under hearing protectors), on a collar, or on the shoulder. (The Mine Safety and Health Administration specifies mounting it on the shoulder.) The electronic monitor is small enough to be carried in a shirt pocket. The monitor accumulates the dose according to the 5 dB exchange rate (or whatever exchange rate the monitor is set for). After the full working day, the monitor is plugged into an indicator section. The noise dose can then be displayed on a 4-digit indicator. The displayed number is the percentage of the OSHA (Occupational Safety and Health Act) criterion limit.

The monitor takes into account fluctuations in level and duration according to the formula set up by OSHA (or for whatever formula the monitor is set). It also includes a cutoff level (or threshold level) below which the integrator does not accumulate any significant equivalent dose.

The present OSHA regulations are as follows (*Federal Register*, May 29, 1971).

*A 4 dB exchange rate also has limited use in the USA.

1910.95 Occupational noise exposure.

(a) Protection against the effects of noise exposure shall be provided when the sound levels exceed those shown in Table G-16 when measured on the A scale of a standard sound level meter at a slow response. . . .

————Table G-16—Permissible Noise Exposures'————

| <i>Duration per day, hours</i> | <i>Sound level dB(A) slow response</i> |
|--------------------------------|--|
| 8 | 90 |
| 6 | 92 |
| 4 | 95 |
| 3 | 97 |
| 2 | 100 |
| 1½ | 102 |
| 1 | 105 |
| ½ | 110 |
| ¼ or less | 115 |

'When the daily noise exposure is composed of two or more periods of noise exposure of different levels, their combined effect should be considered, rather than the individual effect of each. If the sum of the following fractions: $C_1/T_1 + C_2/T_2 + \dots + C_n/T_n$ exceeds unity, then, the mixed exposure should be considered to exceed the limit value, C_n indicates the total time of exposure at a specified noise level, and T_n indicates the total time of exposure permitted at that level.

Exposure to impulsive or impact noise should not exceed 140 dB peak sound pressure level.

(b)(1) When employees are subjected to sound exceeding those listed in Table G-16, feasible administrative or engineering controls shall be utilized. If such controls fail to reduce sound levels within the levels of Table G-16, personal protective equipment shall be provided and used to reduce sound levels within the levels of the table.

(2) If the variations in noise level involve maxima at intervals of 1 second or less, it is to be considered continuous.

(3) In all cases where the sound levels exceed the values shown herein, a continuing, effective hearing conservation program shall be administered.

Present OSHA regulations limit the exposure to continuous sound to a maximum level of 115 dB. The sound is assumed to be continuous even if the sound is impulsive, provided the impulses occur at intervals of 1 second or less. The regulations also state that "exposure to impulsive or impact noise should not exceed 140 dB peak sound pressure level." A proposal from OSHA,* which is not yet in effect, states that "exposures to impulses of 140 dB shall not exceed 100 such impulses per day. For each decrease of 10 dB in the peak sound pressure level of the impulse, the number of impulses to which employees are exposed may be increased by a factor of 10."

When only a sound-level meter is available, the exposure can be estimated from a series of A-weighted measurements if the pattern of noise level variations is simple. For example, the exposure in some work conditions consists of a number of periods within which the noise level is reasonably constant. The level and duration of each of those periods is measured. Then the total equivalent exposure is calculated from the formula given by the OSHA regulations.

Another approach is to use a sound-level meter driving a GR 1985 DC Recorder (see paragraph 10.1) to plot the sound level as a function of time. The chart record can then be analyzed to combine levels and durations as specified in the OSHA formula. The chart record has the advantage of showing the periods of most serious exposure, which may help guide one in the process of reducing the exposure.

The international standard (ISO/R1999-1971) on Assessment of Occupational Noise Exposure for Hearing Conservation Purposes uses an "equivalent con-

*Federal Register, Vol. 39, No. 207, October 24, 1974, p. 37775.

tinuous sound level," which is "that sound level in dB(A) which, if present for 40 hours in one week, produces the same composite noise exposure index as the various measured sound levels over one week." Partial noise exposure indexes E_i are calculated from the formula

$$E_i = \frac{\Delta t_i}{40} 10^{0.1(L_i - 70)}$$

where L_i is the sound level A in dB

and Δt_i is the duration in hours per week during which the sound level is L_i .

These partial indexes are summed to yield a composite exposure index and then transformed to equivalent continuous sound level, L_{eq} , by

$$L_{eq} = 70 + 10 \log_{10} \Sigma E_i$$

This combination is equivalent to the use of a 3 dB exchange rate. The standard also states that when the noise is below 80 dB sound-level A, it can be ignored.

3.4.1 Area Monitoring. The personal noise dosimeter can also be used to monitor the noise level in a work area. When the GR 1954 is used for area monitoring, the monitor is plugged into the indicator and the microphone is positioned on the microphone extension. Then the unit is set up on a tripod, as shown in Figure 3-2. The apparent noise dose can be checked at any time.



Figure 3-2. The noise dosimeter set up for area monitoring.

3.4.2 Position of Microphone. Area versus personal monitoring. The original investigations that were used to find a relation of hearing loss to actual industrial noise exposures were based on measuring the noise levels in the industrial situation without the worker being in the immediate vicinity of the microphone. The main reason for this approach is that it reduced the uncertainties in the measured levels that are caused by a person interfering with the sound field at the microphone. These measurements were then work-area monitoring measurements with the microphone placed where the ears of the worker would normally be, but during the measurement the worker is stationed away from the

microphone. Many industrial work situations can be monitored reasonably well in this way, particularly if during those periods when the noise level is high, the worker is essentially at one fixed location.

There are other jobs, however, where the worker moves about and encounters a wide range of noise levels during the day, for example, mining and construction work. The most satisfactory means of measuring the exposure for this condition is to use the personal noise dosimeter, which stays with the worker. Then the microphone is mounted on the worker and the sound field at the microphone is affected by the worker. The level under these conditions tends to be somewhat higher than when area monitoring is used, because of the buildup of sound pressure near a reflecting surface. The difference in level between the two measurement methods depends on many factors, including the direction of arrival of sound, the spectrum of the sound, and the position of the microphone. Although the difference may be as much as 6 dB, it is usually no more than 2 dB.

Measurements by the use of the personal noise dosimeter can be closer to the actual exposure and should be preferred over area monitoring. But the basis for relating hearing loss and noise exposure needs to be reassessed for this type of noise monitoring. It would appear that monitoring the noise exposure with the sound pickup from a small microphone at the entrance to the ear canal would be preferred. (Each ear would have to be monitored separately.) Then if the noise exposure criteria were based on similar measurements, the uncertainty in the monitoring procedure would be reduced.

3.4.3 Noise Reduction. When noise levels are found to be excessive, a serious effort should be devoted to reducing the noise level at the source or by the use of barriers. Such techniques are discussed in Chapter 16. In addition the exposure should be reduced by shortening the time that any employee remains in hazardous areas.

A further step is to supply employees with personal protection in the form of ear plugs, ear muffs, or helmets. Only those devices of this type specifically designed for noise reduction should be used. Thus, dry cotton or similar material stuffed into the ear canal is not a satisfactory earplug.

One of the problems with personal protective devices is that they are frequently misused or ignored. Because of that problem, it is important to reduce the noise level as much as possible and thereby reduce the dependence on these devices. In addition the worker needs to be convinced of the importance of protecting his hearing, and he must be taught how to use the devices properly. If he is also allowed some choice in the type of protection he uses, that too will help ensure proper use.

AUDIOMETRY PROGRAM

3.5.1 Hearing Monitoring. One important phase of the hearing-conservation program is the regular monitoring of the hearing of employees exposed to noisy environments (Hosey and Powell, 1967). The measurement of the hearing function is called "audiometry," and in industry the usual measurement is a pure-tone absolute-threshold test. (see paragraph 4.3) The record that results from this test is an audiogram. In an audiogram the zero reference line corresponds to a set of standardized normal threshold levels (ISO/R389-1964, ANSI S3.6-1969). The audiometers used in industry are commonly limited to tones having frequencies of 500, 1000, 2000, 3000, 4000 and 6000 Hz.

Automatic audiometers are now widely used, and they record the result with a minimum of operator intervention. An audiogram obtained from such an automatic unit, a Grason—Stadler Model 1703 Audiometer, is shown in Figure 3-3.

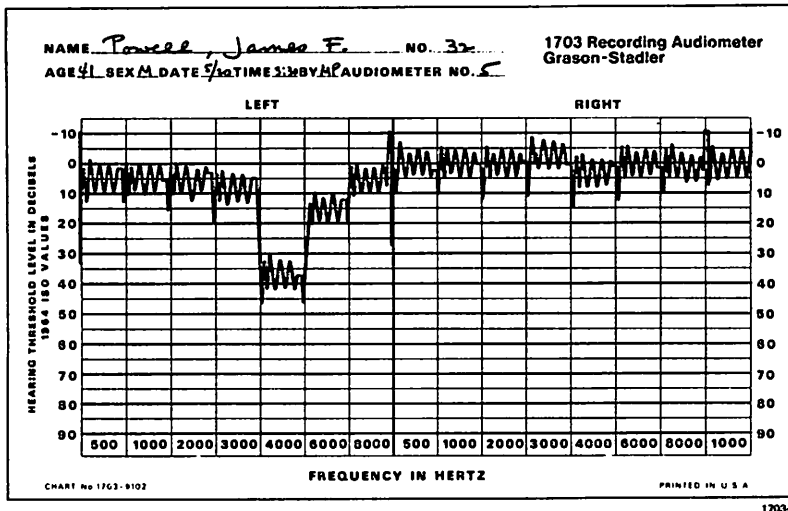

Figure 3-3. Audiogram obtained from an automatic audiometer.

In order to ensure that any audiometer is operating correctly, it needs to be calibrated periodically. Before a series of audiograms are taken, a check of the signal level should be made by use of a calibration set, such as the GenRad 1562-Z Audiometer Calibration Set. It contains a sound-level meter and earphone coupler to measure the output level and frequency response of the audiometer. The GenRad 1933 Audiometer Calibration System provides improved accuracy as well as a check on attenuator linearity. The GenRad 1560-9619 Audiometer Calibration Accessory Kit is designed to be used with a 1982 or 1933 Precision Sound Level Meter for audiometer calibration.

Any industrial audiometric program should include pre-employment screening. The results of such tests provide a reference record of the employee's hearing. Since about one-fourth of new employees have some hearing loss (Maas, 1965) this pre-employment record is important. It may serve to detect a hearing disorder that otherwise might have gone unnoticed. In addition, the worker already exhibiting noticeable hearing loss should be placed where noise levels are generally low. From the employer's viewpoint, this pre-employment record may help to protect against false suits for job-related hearing losses.

Persons stationed in possibly hazardous noise areas must have their hearing checked regularly. The test should be conducted at least 16 hours after any exposure to high noise levels to permit the hearing mechanism sufficient time to recover from the effects of temporary threshold shift. A comparison of current test results with previous results should show if any action needs to be taken to have additional tests or whether other authorities need be consulted on the condition of the employees hearing.

REFERENCES

Standards

ANSI S1.4-1971 Sound-Level Meters

ANSI S1.25-1978 Personal Noise Dosimeters

IEC/651 (1979) Sound-Level Meters

ISO/R1999-1971 Assessment of Occupational Noise Exposure for Hearing Conservation Purposes

Other

Amer. Acad. Ophthalmology and Otolaryngology (AAOO), "Guide for Conservation of Hearing in Noise." (Committee on the Conservation of Hearing, c/o Callier Hearing and Speech Center, 1966 Inwood Road, Dallas, Texas 75325).

American Conference Governmental Industrial Hygienists, *Threshold Limit Values of Physical Agents Adopted by ACGIH*, 1014 Broadway, Cincinnati, OH 45202.

American Industrial Hygiene Association (AIHA) (1975), *Industrial Noise Manual*, Third edition, AIHA, 66 S. Miller Rd., Akron, OH 44133.

W.L. Baughn (1973), *Relation Between Daily Noise Exposure and Hearing Loss Based on the Evaluation of 6835 Industrial Noise Exposure Cases*, Aerospace Medical Research Laboratory, WPAFB, Ohio, June 1973, AMRL-TR-73-53, AD 767 204.

W. Burns and D.W. Robinson (1970), *Hearing and Noise in Industry*, Her Majesty's Stationery Office, London, England.

A.L. Cudworth (1979), "Hearing Loss: Legal Liabilities," Chapter 13 in Harris (1979).

H. Davis and S.R. Silverman (1978), *Hearing and Deafness*, Fourth edition, Holt, Reinhart, and Winston, N.Y.

John Fosbroke (1831), "Practical Observations on the Pathology and Treatment of Deafness," No. II, *The Lancet*, 1830-31, Vol. I, pp. 645-648.

A. Glorig, W.D. Ward, and J. Nixon (1961), "Damage Risk Criteria and Noise-Induced Hearing Loss," *Arch Oto-laryngol*, Vol. 74, 1961, pp. 413-423.

C.M. Harris (1979), *Handbook of Noise Control*, McGraw-Hill, N.Y.

A.D. Hosey and C.H. Powell, eds. (1967), "Industrial Noise, A guide to its Evaluation and Control," US Dept. of Health, Education, and Welfare, public Health Service Publication #1572, US Govt. Printing Office, Washington, DC 20402.

K.D. Kryter, W.D. Ward, J.D. Miller, and D.H. Eldredge (1966), "Hazardous Exposure to Intermittent and Steady-State Noise," *J Acoust Soc Am*, Vol. 39, #3, March 1966, pp. 431-464.

R.M. Maas (1965), "Hearing Conservation — Legislation, Insurance and Compensation Claims," Second Annual Symposium on Noise Effects in Industry, The East Range Clinic, Dept. of Ind. Med., June 1965, pp. 11-12.

W. Melnick (1979), "Hearing Loss from Noise Exposure," Chapter 9 in Harris (1979).

J.D. Miller (1974), "Effects of Noise on People," *J. Acoust. Soc. Am.*, Vol. 56, #3, Sept. 1974, pp. 729-764.

M.H. Miller (1979), "Hearing Conservation Programs in Industry," Chapter 11 in Harris (1979).

M.H. Miller and J.D. Harris (1979), "Hearing Testing in Industry," Chapter 10 in Harris (1979).

M.L. Miller and A.M. Keller (1979), "Regulation of Occupational Noise," Chapter 40 in Harris (1979).

Mine Safety and Health Administration (MSHA) (1978), CFR, Title 30, Chapter I, April 19, 1978, Subchapter N, Paragraphs 55.5-50, 56.5-50, 57.5-50, Physical Agents, Noise.

Mine Safety and Health Administration (MSHA) (1978), "Use of Personal Noise Dosimeters," Coal Mine Health and Safety, *Federal Register*, Sept. 12, 1978, Part VIII, Vol. 43, #172.

C.W. Nixon (1979), "Hearing Protective Devices: Ear Protectors," Chapter 12 in Harris (1979).

Occupational Safety and Health Administration (OSHA) (1971), 29 CFR 1910.95, 36 Fed. Reg. 10466, 10518.

OSHA (1974), "Proposed Occupational Noise Exposure Regulation," 39 Fed. Reg. 37773 (24 October 1974).

J. Tonndorf, H.E. von Gierke, and W.D. Ward (1979), "Criteria for Noise and Vibration Exposure," Chapter 18 in Harris (1979).

US Environmental Protection Agency (1974), *Information on Levels of Environmental Noise Requisite to Protect Public Health and Welfare with an Adequate Margin of Safety*, No. 550/9-74-004, US EPA, Washington, DC 20460. (This publication is often called the "Levels" document.)

Chapter 4

Other Effects of Noise

4.1 WHY WE MEASURE NOISE.

That very intense noise may cause hearing loss, that we are annoyed by a noisy device and a noisy environment, or that noise may interfere with our sleep, our work, and our recreation is frequently the basic fact that leads to noise measurements and attempts at quieting. In order to make the most significant measurements and to do the job of quieting most efficiently, it is clearly necessary to learn about these effects of noise. We seek to estimate from these effects what levels of noise are acceptable, and thus establish suitable noise criteria. Then if we measure the existing noise level, the difference between this level and the acceptable level is the noise reduction necessary.

Unfortunately, not all the factors involved in annoyance, interference, and hearing loss are known at present. Nor are we yet sure how the known factors can best be used. But a brief discussion of our reactions to sounds will serve to show some of the factors and their relative significance. This information will be useful as a guide for selecting electronic equipment to make the most significant measurements for the problem at hand.

4.2 PSYCHOACOUSTICAL EXPERIMENTS.

Scientists and engineers have investigated many aspects of man's reactions to sounds (Stevens, 1951). For example, they have measured the levels of the weakest sounds that various observers could just hear in a very quiet room (threshold of hearing), they have measured the levels of the sounds that are sufficiently high in level to cause pain (threshold of pain), and they have measured the least change in level and in frequency that various observers could detect (differential threshold). These experimenters have also asked various observers to set the levels of some sounds so that they are judged equal in loudness to reference sounds (equal loudness), and they have asked the observers to rate sounds for loudness on a numerical scale.

In order to get reliable measures of these reactions, the experimenters have to simplify the conditions under which people react to sounds. This simplification is mainly one of maintaining unchanged as many conditions as possible while a relatively few characteristics of the sound are varied. Some of the conditions that have to be controlled and specified are the following: the physical environment of the observer, particularly the background or ambient level; the method of presenting the changing signals, including the order of presentation, duration, frequency, and intensity; the selection of the observers; the instructions to the observers; the experience of the observers in the specific test procedure; the normal hearing characteristics of the observers; the responses; and the method of handling the data.

Variations in the conditions of the measurement will affect the result. Such interaction is the reason for requiring controlled and specified conditions. It is desirable to know, however, how much the various conditions do affect the result. For example, small changes in room temperature are usually of little significance. But if the observer is exposed to a noise of even moderate level just

before a threshold measurement, the measured threshold level will, temporarily, be significantly higher than normal.

The basic method used by the observer to present his reaction to the signals is also important in the end result. Numerous methods have been developed for this presentation. Three of these psychophysical methods are as follows:

1. In the method of adjustment, the observer sets an adjustable control to the level he judges suitable for the test.
2. In the method of the just-noticeable difference, the observer states when two signals differ sufficiently, so that he can tell they are different.
3. In the method of constant stimuli, the observer states whether two signals are the same, or which is the greater, if they seem to differ.

The approach an observer takes in making a decision is significant. If an observer attempts to detect a signal that is sometimes present in a background of noise, four possible conditions exist. With the signal present or absent, he may respond that it is or is not present. The choice he makes can be influenced by the instructions. On the one hand, he may be told that false alarms are serious errors and that he should respond that the signal is present only if he is very certain of it. Or he may be told that occasional false alarms are unimportant. These different instructions will produce different approaches to the decision problem and will affect the results of the experiment. These factors have been organized in modern detection theory (Green and Swets, 1966) to permit a quantitative approach to such psychoacoustic problems by the use of a "receiver-operating characteristic," usually called "ROC." Experiments based on this theory have also shown that earlier concepts of a "threshold" are oversimplified. We shall, however, use the term threshold here without attempting to define it accurately, since it is a readily accepted concept, and it is adequate for the present discussion.

When psychoacoustical experiments are performed, the resultant data show variability in the judgments of a given observer as well as variability in the judgments of a group of observers. The data must then be handled by statistical methods, to obtain an average result as well as a measure of the deviations from the average. In general, it is the average result that is of most interest but the extent of the deviations is also of value, and in some experiments these deviations are of major interest.

The deviations are not usually shown on graphs of averaged psychoacoustical data, but they should be kept in mind. To picture these deviations one might think of the curves as if they were drawn with a wide brush instead of a fine pen.

The measured psychoacoustical responses also have a certain degree of stability, although it is not the degree of stability that we find in physical measurements. In the normal course of events, if one's threshold of hearing is measured today, a similar measurement tomorrow should give the same threshold level within a few decibels.

In the process of standardizing the measurement conditions for the sake of reliability and stability, the experiments have been controlled to the point where they do not duplicate the conditions encountered in actual practice. They are then useful mainly as a guide in interpreting objective measurements in subjective terms, provided one allows for those conditions that seriously affect the result. As a general rule, the trend of human reactions to changes in the sound is all that can be estimated with validity. A conservative approach in using psychoacoustical data with some margin as an engineering safety factor, is usually essential in actual practice.

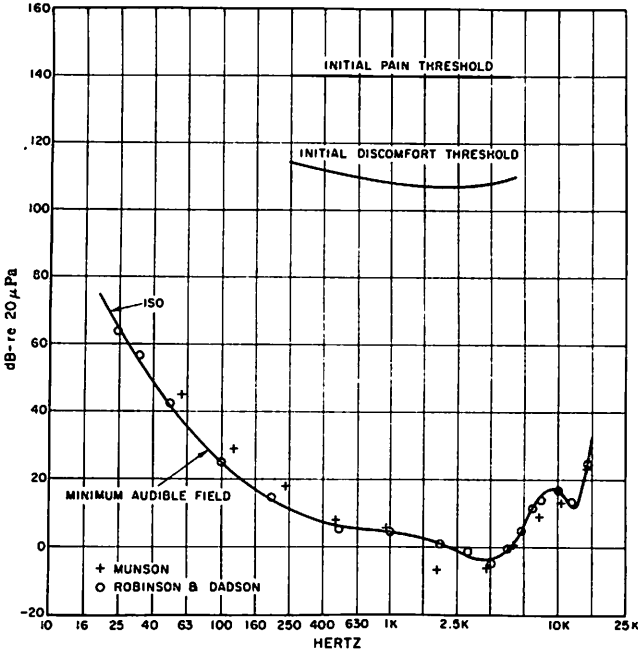

Figure 4-1. Thresholds of hearing and tolerance.

4.3 THRESHOLDS OF HEARING AND TOLERANCE.

Many experimenters have made measurements of the threshold of hearing of various observers. When young persons with good hearing are tested, a characteristic similar to that labeled minimum audible field (MAF) in Figure 4-1 is usually obtained. This shows the level of the simple tone that can just be heard in an exceptionally quiet location under free-field conditions (see Chapter 13 for an explanation of "free-field") as a function of the frequency of the tone. For example, if a simple tone having a frequency of 250 Hz (about the same as the fundamental frequency of middle C) is sounded in a very quiet location, and if its sound-pressure level is greater than 12 dB re 20 μPa at the ear of the listener, it will usually be heard by a young person.

The results of two of the classical determinations of the minimum audible field are shown in the figure. Both were very carefully done. The values shown by the crosses were obtained by Munson on a group of 8 men and 2 women, average age of 24 (Sivian and White, 1933), when only a few laboratories could make accurate acoustical measurements. The values shown by the circles are a result of the extensive set of measurements made by Robinson and Dadson (1956) on 51 young people, average age of 20. The smooth curve is the one given in the international standard, ISO R226-1967.

Some variation in the threshold of a person can be expected even if the experiments are carefully controlled. Threshold determinations made in rapid succession may possibly differ by as much as 5 dB, and with longer intervals more variation between values is possible. But the average of a number of threshold measurements will generally be consistent with the average of another set to within less than 5 dB.

The variability among individuals is, of course, much greater than the day-to-day variability of a single individual. For example, the sensitivity of some young people is slightly better than that shown in Figure 4-1 as the minimum audible field, and, at the other extreme, some people have no usable hearing. Most noise-quieting problems, however, involve people whose hearing characteristics, on the average, are only somewhat poorer than shown in Figure 4-1.

The threshold curve (Figure 4-1) shows that at low frequencies the sound-pressure level must be comparatively high before the tone can be heard. In contrast we can hear tones in the frequency range from 200 to 10,000 Hz even though the levels are very low. This variation in acuity of hearing with frequency is one of the reasons that in most noise problems it is essential to know the frequency composition of the noise. For example, is it made up of a number of components all below 100 Hz? Or are they all between 1000 and 5000 Hz? The importance of a given sound-pressure level is significantly different in those two examples.

The upper limit of frequency at which we can hear air-borne sounds depends primarily on the condition of our hearing and on the intensity of the sound. This upper limit is usually quoted as being somewhere between 16,000 and 20,000 Hz. For most practical purposes the actual figure is not important.

Many hearing-threshold measurements are made by otologists and audiologists and other hearing specialists in the process of analyzing the condition of a person's hearing. An instrument known as an "audiometer" is used for this purpose. Why and how this instrument is used is covered in Chapter 3.

When a sound is very high in level, one can feel very uncomfortable listening to it. The "Discomfort Threshold" (Silverman, 1947), shown in Figure 4-1 at about 120 dB, is drawn in to show the general level at which such a reaction is to be expected for pure tones. At still higher levels the sound will become painful and the order of magnitude of these levels (Silverman, 1947) is also shown in Figure 4-1. The thresholds for discomfort are significantly lower (about 10 dB) on initial exposure and rise after repeated exposures to such high levels.

4.3.1 Hearing loss with Age — Presbycusis. The expected loss in hearing sensitivity with age has been determined by statistical analysis of hearing threshold measurements on many people. An analysis of such data has given the results shown in Figure 4-2 (Spoor, 1967). This set of curves shows, for a number of simple tones of differing frequencies, the extent of the shift in threshold that we can expect, on the average, as we grow older. It is shown there that the loss becomes increasingly severe at higher frequencies, and it is obvious that an upper hearing-frequency-limit of 20,000 Hz applies only to young people.

The curves shown are given in terms of the shift with respect to the 25-year age group. The shifts in hearing sensitivity represent the effects of a combination of aging (presbycusis) and the normal stresses and nonoccupational noises of modern civilization (sociocusis) (Glorig, 1958). Such curves are usually called "presbycusis curves," even though they do not represent pure physiological aging, and they are used to help determine if the hearing of an older person is about what would be expected.

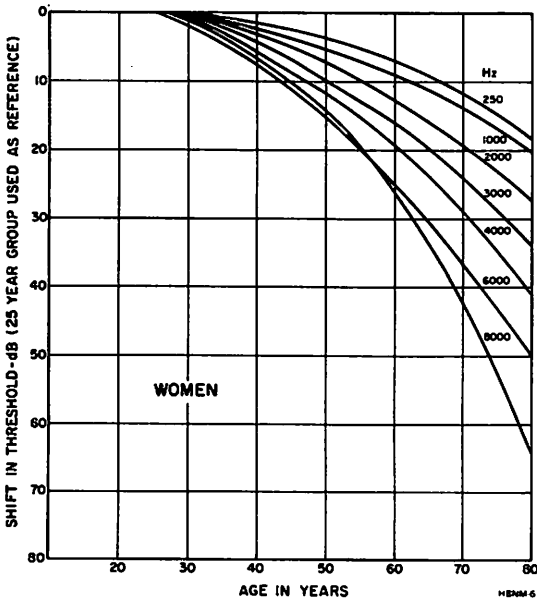
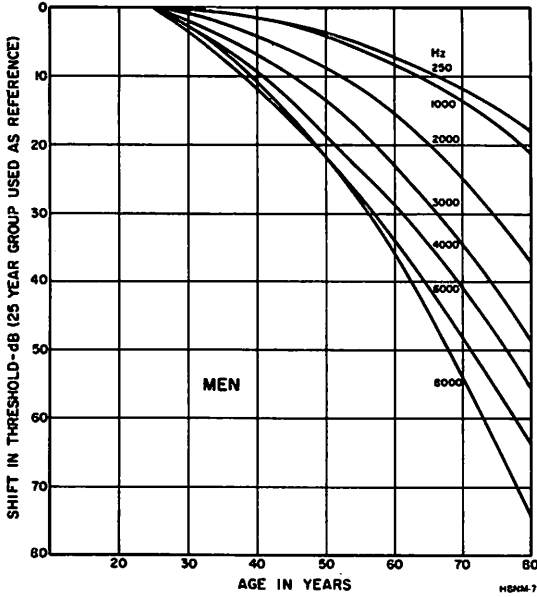

Figure 4-2. The average shifts with age of the threshold of hearing for pure tones of persons with "normal" hearing. (Spoor, 1967).

4.3.2 Hearing Loss From Noise Exposure. Exposure to loud noise may lead to a loss in hearing, which will appear as a shift in the hearing threshold. This effect of noise is so important that the previous chapter is devoted to it.

4.3.3 Other Causes of Hearing Loss. There are so many possible contributing factors to hearing loss (Davis and Silverman, 1978) that we cannot review them here. But to remind one that aging and noise are only two of the many possible factors, here are some of the more obvious contributors — congenital defects, anatomical injuries, and disease.

4.4 HOW ANNOYING IS NOISE?

No adequate measures of the annoyance levels of noises have yet been devised. Various aspects of the problem have been investigated, but the psychological difficulties in making these investigations are very great. For example, the extent of our annoyance depends greatly on what we are trying to do at the moment, it depends on our previous conditioning, and it depends on the character of the noise.

The annoyance level of a noise is sometimes assumed to be related directly to the loudness level of the noise. Although not completely justifiable, this assumption is sometimes helpful because a loud sound is usually more annoying than one of similar character that is not so loud.

This approach is one of the reasons that so many experiments have been made on judged loudness of various sounds, and procedures have been developed for predicting the loudness of noise from physical measurements. Some of the results of these experiments will be reviewed in the next section. In addition other experiments have been made in which listeners have been asked to judge noises for their “noisiness,”* “unacceptability,” “objectionability,” “annoyingness,” or on how “disturbing” they were. Some of these experiments have led to the concept of “perceived noise level” and “noisiness.” Since perceived noise level has been used widely, it too is described in more detail below.

In a comprehensive review of such experiments Stevens (1972) shows how remarkably similar most of the results are. One is led to the conclusions that these distinct terms do not produce really significant differences in judgment at least for the controlled experimental conditions. He has used the available evidence to produce a new, but related, procedure for predicting the “perceived level” and the “perceived magnitude” from physical measurements of a noise. This procedure, called “Mark VII,” is also described below.

One conclusion that can be drawn from these experiments is that high-frequency sounds (in the vicinity of 5000 Hz) are usually louder, more annoying or disturbing than are lower-frequency sounds of the same sound-pressure level. Therefore, when it is determined, by methods to be explained later, that a significant portion of the noise is in this higher-frequency region, considerable effort at reducing these levels from the viewpoint of annoyance may be justified.

A rather different effect that may determine some of the annoying quality of a sound concerns its localization. When a large office has acoustically hard walls, floor, and ceiling, the room is “live,” reverberant. The noise from any office machinery then is reflected back and forth, and the workers are immersed in the noise with the feeling that it comes from everywhere. If the office is heavily treated with absorbing material, the reflected sound is reduced, and the workers then feel that the noise is coming directly from the machine. This localized noise seems to be less annoying. While no adequate measures of this effect have been developed, the general principle discussed here seems to be accepted by many who are experienced in noise problems.

*As an old saying would have it, “a noisy noise annoys an oyster.”

4.5 RATING THE LOUDNESS OF A SOUND.

Many psychoacoustical experiments have been made in which listeners have been asked to rate the loudness of a sound. As a result of these experiments, involving all sorts of sounds in various arrangements, much has been learned about the concept of loudness in laboratory situations. The way in which the judgment of loudness is obtained seems to affect the results sufficiently, however, so that we cannot reliably scale all the sounds of everyday life on an absolute basis. In particular, it does not seem possible to give a numerical value to the loudness ratio of two sounds and have this ratio be reasonably independent of the conditions of comparison. It does seem possible, however, to rank a sound with satisfactory reliability according to its loudness. For example, if sound A is judged louder than sound B and if sound B is judged louder than sound C, then, in general, sound A will also be judged louder than sound C.

4.5.1 Equal-Loudness Contours. One step in the direction of rating the loudness of a sound has been to determine the sound-pressure levels of simple tones of various frequencies that sound just as loud to an observer as a 1000-Hz tone of a given sound-pressure level. The results of this determination by Robinson and Dadson based on the averages of many observations, are given as equal-loudness contours in Figure 4-3. The number on each curve is the sound-pressure

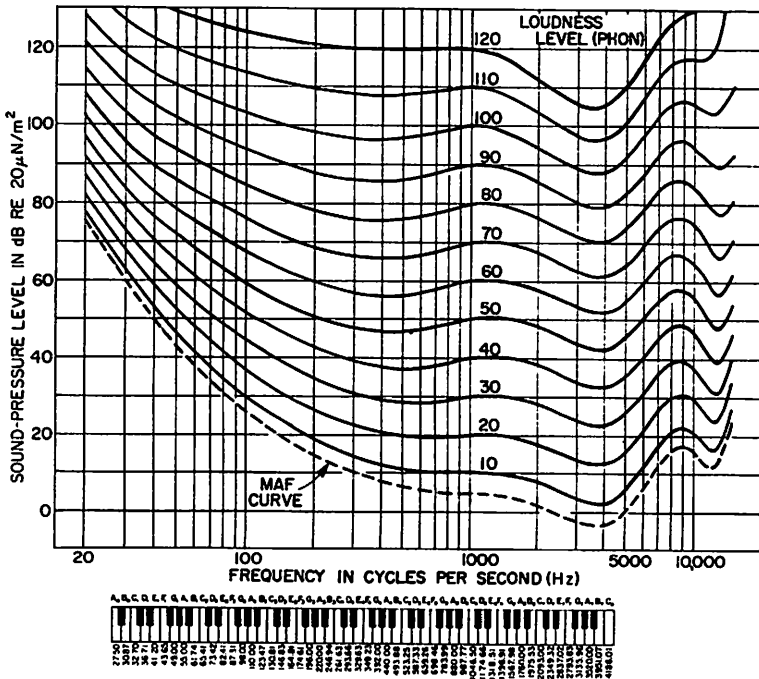

Figure 4-3. Free-field equal-loudness contours for pure tones (observer facing source), determined by Robinson and Dadson 1956 at the National Physical Laboratory, Teddington, England. (ISO/R226-1961) Piano Keyboard helps identify the frequency scale. Only the fundamental frequency of each piano key is indicated.

level of the 1000-Hz tone used for comparison for that curve. To use the contours for determining the equally loud levels at other frequencies, we find the point on the curve corresponding to the desired frequency and read off the corresponding sound-pressure level as the ordinate. For example, the 60-dB contour line shows that a 67-dB level at 100 Hz is just as loud as a 60-dB 1000-Hz tone. We can also interpolate to find that a 60-dB 100-Hz tone is equal in loudness to a 51-dB 1000-Hz tone. The corresponding sound-pressure level in dB for the 1000-Hz tone has been defined as the *loudness level* in *phons*. Therefore, a 100-Hz tone at a sound-pressure level of 60 dB has a loudness level of 51 phons.

The weighting networks for the standard sound-level meter are based on similar contours developed much earlier by Fletcher and Munson (1933). The "A" and "B" weighting characteristics are in accordance with the 40- and 70-phon Fletcher-Munson contours, but with modifications to take into account the usually random nature of the sound field in a room and to simplify their simulation with electrical networks.

A set of equal-loudness contours (Pollack, 1952) for bands of random noise is shown in Figure 4-4. Random noise is a common type of noise that occurs in ventilating systems, jets, blowers, combustion chambers, etc. It does not have a well-defined pitch, such as characterizes a tone with the energy concentrated in components of definite frequencies. Rather, random noise has energy distributed over a band of frequencies. If the noise energy is uniform over a wide range, it is called "white noise," being analogous in spectrum characteristics to white light. When the energy is distributed over a very wide band, it is a sort of "hissing" sound. When the broadband noise has little energy at low frequencies, it is more of a hissing sound. When it is concentrated in narrower bands, the sound takes on some aspects of pitch. For example, low-frequency random noise may be a sort of roar.

The contours shown in Figure 4-4 are for relatively narrow bands of noise, such that 11 bands cover the range from 60 to 5800 Hz. They are distributed uniformly on a scale of pitch for simple tones (see 4.20.2). The numbers on the curves are phons, that is, the sound-pressure levels of equally loud 1000-Hz tones, and the levels are plotted according to the centers of the bands. For example, one band covers the range from 350 to 700 Hz. From the curves we can see that when the sound-pressure level of the noise in that band is 43 dB re $20 \mu\text{N}/\text{m}^2$, the indicated loudness level is about 34 phons.

Figure 4-4. Equal-loudness contours for relatively narrow bands of random noise. The center frequency of the band is shown as the abscissa, and the numbers on the curves are phons (Pollack, 1952).

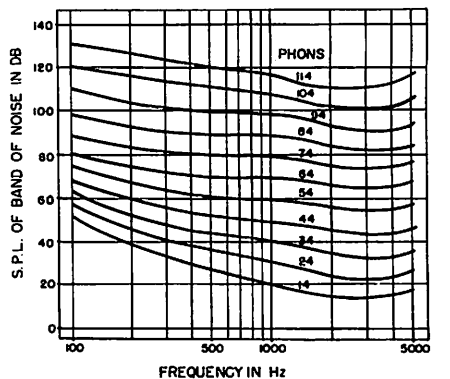

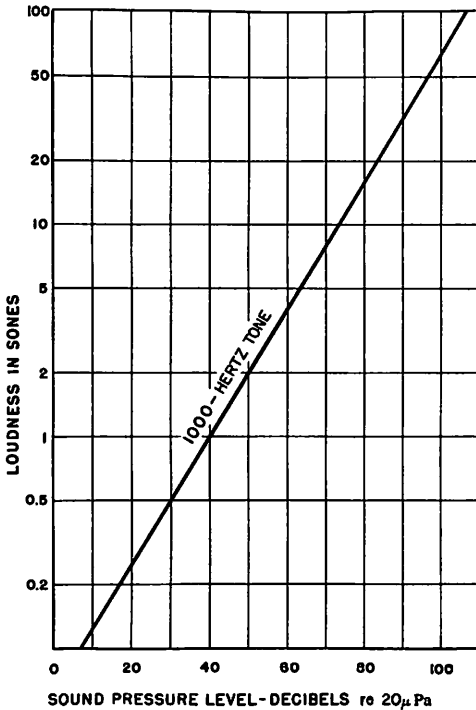

Figure 4-5. Loudness vs sound-pressure level for a pure tone of 1000 Hz.

4.5.2 Loudness and Loudness Level. Although we may remark that some sounds are louder than others, we do not ordinarily rate sounds for loudness on a numerical basis. Experimenters have asked observers to make judgments on the loudness ratio of sounds, that is, to state when one sound is twice, four times, one-half, etc., as loud as another. The resultant judgments depend to a considerable extent on how the problem is presented to the observer. But on the basis of such judgments, several scales of loudness have been devised, which rate sounds from “soft” to “loud” in units of *sones*. As a reference, the loudness of a 1000-Hz tone with a sound-pressure level of 40 dB re 20 μ Pa (a loudness level of 40 phons) is taken to be 1 sone. A tone that sounds twice as loud has a loudness of 2 sones. This scale is shown on the vertical axis of Figure 4-5, and the horizontal scale is the sound-pressure level of the sound in decibels. The curve shown in this figure relates the loudness in sones to the sound-pressure level for a 1000-Hz simple tone. This relation was developed as a useful engineering approximation by Stevens as a result of his analysis of the data reported by many experimenters, who used a wide variety of techniques. He also performed a series of experiments in which the loudness estimates were made on an unusually direct basis, and these experiments confirmed the relation shown. Robinson has also suggested this relation, which is published as a Recommendation of the International Standards Organization (ISO R131-1959).

Incidentally, the relation shown in Figure 4-5 tends to refute the point of view that the decibel is used in acoustics because we respond to sound pressure in a logarithmic manner. Actually, the loudness is approximately proportional to the sound pressure raised to the 0.6 power.

4.5.3 Loudness-Level Calculations. If the sound to be measured is known to be a simple tone, the procedure for determination of loudness level is relatively easy. The sound-pressure level and the frequency of the tone are determined, and the equal-loudness contours of Figure 4-3 then indicate the loudness level. Since the weighting networks on a sound-level meter approximate two of the equal-loudness contours, a determination of the weighted level (sound level) can be used to give an estimate of the loudness level of a simple tone.

For any other type of sound, however, the measured sound level will be lower than the loudness level. The error in estimating loudness level will depend on the type of sound and for many noises will be more than 10 phons. For example, if we have a uniform wide-band noise from 20 to 6000 Hz of 80-dB sound-pressure level, the B-weighted sound level would be about 79 dB and the A-weighted sound level would be about 80 dB, whereas the actual loudness level of such a noise is about 95 phons. Here we see that the sound level is not only misleading, but is no nearer the loudness level than is the sound-pressure level. This result, for most noises, illustrates the fact that we need to know more about a sound than just its sound-pressure level or its sound level. If we know how the energy in a sound is distributed as a function of frequency, we can make a more useful estimate of its probable subjective effect than we can by knowing just its sound-pressure level. One of the ways such knowledge is used is the calculation of loudness level.

A number of workers in noise measurements have found it useful to translate their noise measurements into such loudness terms. Then they can say the measured sound is, for example, about equal in loudness to another, more familiar, sound. To some groups, such as executive and lay clients, this type of statement is seemingly more meaningful than levels quoted in decibels.

For steady, wide-band noises, a technique developed by Stevens has been found to give good results. The sound is divided by an analyzer into frequency bands covering the audio spectrum. The loudness level is then calculated according to the procedure given in the next section.

A set of 8 or 9 octave bands is most often used for this purpose. These have center frequencies of 31.5, 63, 125, 250, 500, 1000, 2000, 4000 and 8000 Hz, with each band actually covering a 2:1 frequency range. A more detailed division provided by a third-octave analysis is also widely used. Both of these band divisions are described in more detail in Chapter 8.

◆ **4.5.4 Procedure for Calculating Loudness*.** Table 4-1 is used to calculate the loudness for octave-band levels of the preferred series. The procedure is as follows:

1. From the table find the proper loudness index for each band level.
2. Add all the loudness indexes (ΣS).
3. Multiply this sum by 0.3.
4. Add this product to 0.7 of the index for that band that has the largest index ($0.3 \Sigma S + 0.7 S_{max}$). This value is the total loudness in sones.
5. This total loudness is then converted to loudness level in phons by the relation shown in the two columns at the right of the table.

*The method used here is that standardized in ANSI S3.4-1968 and originally given by S.S. Stevens (1961).

◆ The diamond is used to indicate sections that are specialized or relatively technical.

Table 4-1.
BAND LEVEL CONVERSION TO LOUDNESS INDEX

| Band Level | Band Loudness Index | | | | | | | | | Loudness | Loudness Level |
|------------|---------------------|------|------|------|------|------|------|------|------|----------|----------------|
| | dB | 31.5 | 63 | 125 | 250 | 500 | 1000 | 2000 | 4000 | 8000 | Sones |
| 20 | | | | | | .18 | .30 | .45 | .61 | .25 | 20 |
| 21 | | | | | | .22 | .35 | .50 | .67 | .27 | 21 |
| 22 | | | | | | .26 | .40 | .55 | .73 | .29 | 22 |
| 23 | | | | | | .30 | .45 | .61 | .80 | .31 | 23 |
| 24 | | | | | | .35 | .50 | .67 | .87 | .33 | 24 |
| 25 | | | | | | .40 | .55 | .73 | .94 | .35 | 25 |
| 26 | | | | | | .45 | .61 | .80 | 1.02 | .38 | 26 |
| 27 | | | | | | .50 | .67 | .87 | 1.10 | .41 | 27 |
| 28 | | | | .07 | | .55 | .73 | .94 | 1.18 | .44 | 28 |
| 29 | | | | .12 | | .61 | .80 | 1.02 | 1.27 | .47 | 29 |
| 30 | | | | .16 | .49 | .67 | .87 | 1.10 | 1.35 | .50 | 30 |
| 31 | | | | .21 | .55 | .73 | .94 | 1.18 | 1.44 | .54 | 31 |
| 32 | | | | .26 | .61 | .80 | 1.02 | 1.27 | 1.54 | .57 | 32 |
| 33 | | | | .31 | .67 | .87 | 1.10 | 1.35 | 1.64 | .62 | 33 |
| 34 | | | .07 | .37 | .73 | .94 | 1.18 | 1.44 | 1.75 | .66 | 34 |
| 35 | | | .12 | .43 | .80 | 1.02 | 1.27 | 1.54 | 1.87 | .71 | 35 |
| 36 | | | .16 | .49 | .87 | 1.10 | 1.35 | 1.64 | 1.99 | .76 | 36 |
| 37 | | | .21 | .55 | .94 | 1.18 | 1.44 | 1.75 | 2.11 | .81 | 37 |
| 38 | | | .26 | .62 | 1.02 | 1.27 | 1.54 | 1.87 | 2.24 | .87 | 38 |
| 39 | | | .31 | .69 | 1.10 | 1.35 | 1.64 | 1.99 | 2.38 | .93 | 39 |
| 40 | | .07 | .37 | .77 | 1.18 | 1.44 | 1.75 | 2.11 | 2.53 | 1.00 | 40 |
| 41 | | .12 | .43 | .85 | 1.27 | 1.54 | 1.87 | 2.24 | 2.68 | 1.07 | 41 |
| 42 | | .16 | .49 | .94 | 1.35 | 1.64 | 1.99 | 2.38 | 2.84 | 1.15 | 42 |
| 43 | | .21 | .55 | 1.04 | 1.44 | 1.75 | 2.11 | 2.53 | 3.0 | 1.23 | 43 |
| 44 | | .26 | .62 | 1.13 | 1.54 | 1.87 | 2.24 | 2.68 | 3.2 | 1.32 | 44 |
| 45 | | .31 | .69 | 1.23 | 1.64 | 1.99 | 2.38 | 2.84 | 3.4 | 1.41 | 45 |
| 46 | .07 | .37 | .77 | 1.33 | 1.75 | 2.11 | 2.53 | 3.0 | 3.6 | 1.52 | 46 |
| 47 | .12 | .43 | .85 | 1.44 | 1.87 | 2.24 | 2.68 | 3.2 | 3.8 | 1.62 | 47 |
| 48 | .16 | .49 | .94 | 1.56 | 1.99 | 2.38 | 2.84 | 3.4 | 4.1 | 1.74 | 48 |
| 49 | .21 | .55 | 1.04 | 1.69 | 2.11 | 2.53 | 3.0 | 3.6 | 4.3 | 1.87 | 49 |
| 50 | .26 | .62 | 1.13 | 1.82 | 2.24 | 2.68 | 3.2 | 3.8 | 4.6 | 2.00 | 50 |
| 51 | .31 | .69 | 1.23 | 1.96 | 2.38 | 2.84 | 3.4 | 4.1 | 4.9 | 2.14 | 51 |
| 52 | .37 | .77 | 1.33 | 2.11 | 2.53 | 3.0 | 3.6 | 4.3 | 5.2 | 2.30 | 52 |
| 53 | .43 | .85 | 1.44 | 2.24 | 2.68 | 3.2 | 3.8 | 4.6 | 5.5 | 2.46 | 53 |
| 54 | .49 | .94 | 1.56 | 2.38 | 2.84 | 3.4 | 4.1 | 4.9 | 5.8 | 2.64 | 54 |
| 55 | .55 | 1.04 | 1.69 | 2.53 | 3.0 | 3.6 | 4.3 | 5.2 | 6.2 | 2.83 | 55 |
| 56 | .62 | 1.13 | 1.82 | 2.68 | 3.2 | 3.8 | 4.6 | 5.5 | 6.6 | 3.03 | 56 |
| 57 | .69 | 1.23 | 1.96 | 2.84 | 3.4 | 4.1 | 4.9 | 5.8 | 7.0 | 3.25 | 57 |
| 58 | .77 | 1.33 | 2.11 | 3.0 | 3.6 | 4.3 | 5.2 | 6.2 | 7.4 | 3.48 | 58 |
| 59 | .85 | 1.44 | 2.27 | 3.2 | 3.8 | 4.6 | 5.5 | 6.6 | 7.8 | 3.73 | 59 |
| 60 | .94 | 1.56 | 2.44 | 3.4 | 4.1 | 4.9 | 5.8 | 7.0 | 8.3 | 4.00 | 60 |
| 61 | 1.04 | 1.69 | 2.62 | 3.6 | 4.3 | 5.2 | 6.2 | 7.4 | 8.8 | 4.29 | 61 |
| 62 | 1.13 | 1.82 | 2.81 | 3.8 | 4.6 | 5.5 | 6.6 | 7.8 | 9.3 | 4.59 | 62 |
| 63 | 1.23 | 1.96 | 3.0 | 4.1 | 4.9 | 5.8 | 7.0 | 8.3 | 9.9 | 4.92 | 63 |
| 64 | 1.33 | 2.11 | 3.2 | 4.3 | 5.2 | 6.2 | 7.4 | 8.8 | 10.5 | 5.28 | 64 |
| 65 | 1.44 | 2.27 | 3.5 | 4.6 | 5.5 | 6.6 | 7.8 | 9.3 | 11.1 | 5.66 | 65 |
| 66 | 1.56 | 2.44 | 3.7 | 4.9 | 5.8 | 7.0 | 8.3 | 9.9 | 11.8 | 6.06 | 66 |
| 67 | 1.69 | 2.62 | 4.0 | 5.2 | 6.2 | 7.4 | 8.8 | 10.5 | 12.6 | 6.50 | 67 |
| 68 | 1.82 | 2.81 | 4.3 | 5.5 | 6.6 | 7.8 | 9.3 | 11.1 | 13.5 | 6.96 | 68 |
| 69 | 1.96 | 3.0 | 4.7 | 5.8 | 7.0 | 8.3 | 9.9 | 11.8 | 14.4 | 7.46 | 69 |
| 70 | 2.11 | 3.2 | 5.0 | 6.2 | 7.4 | 8.8 | 10.5 | 12.6 | 15.3 | 8.00 | 70 |
| 71 | 2.27 | 3.5 | 5.4 | 6.6 | 7.8 | 9.3 | 11.1 | 13.5 | 16.4 | 8.6 | 71 |
| 72 | 2.44 | 3.7 | 5.8 | 7.0 | 8.3 | 9.9 | 11.8 | 14.4 | 17.5 | 9.2 | 72 |
| 73 | 2.62 | 4.0 | 6.2 | 7.4 | 8.8 | 10.5 | 12.6 | 15.3 | 18.7 | 9.8 | 73 |
| 74 | 2.81 | 4.3 | 6.6 | 7.8 | 9.3 | 11.1 | 13.5 | 16.4 | 20.0 | 10.6 | 74 |
| 75 | 3.0 | 4.7 | 7.0 | 8.3 | 9.9 | 11.8 | 14.4 | 17.5 | 21.4 | 11.3 | 75 |
| 76 | 3.2 | 5.0 | 7.4 | 8.8 | 10.5 | 12.6 | 15.3 | 18.7 | 23.0 | 12.1 | 76 |
| 77 | 3.5 | 5.4 | 7.8 | 9.3 | 11.1 | 13.5 | 16.4 | 20.0 | 24.7 | 13.0 | 77 |
| 78 | 3.7 | 5.8 | 8.3 | 9.9 | 11.8 | 14.4 | 17.5 | 21.4 | 26.5 | 13.9 | 78 |
| 79 | 4.0 | 6.2 | 8.8 | 10.5 | 12.6 | 15.3 | 18.7 | 23.0 | 28.5 | 14.9 | 79 |
| 80 | 4.3 | 6.7 | 9.3 | 11.1 | 13.5 | 16.4 | 20.0 | 24.7 | 30.5 | 16.0 | 80 |
| 81 | 4.7 | 7.2 | 9.9 | 11.8 | 14.4 | 17.5 | 21.4 | 26.5 | 32.9 | 17.1 | 81 |
| 82 | 5.0 | 7.7 | 10.5 | 12.6 | 15.3 | 18.7 | 23.0 | 28.5 | 35.3 | 18.4 | 82 |
| 83 | 5.4 | 8.2 | 11.1 | 13.5 | 16.4 | 20.0 | 24.7 | 30.5 | 38 | 19.7 | 83 |
| 84 | 5.8 | 8.8 | 11.8 | 14.4 | 17.5 | 21.4 | 26.5 | 32.9 | 41 | 21.1 | 84 |
| 85 | 6.2 | 9.4 | 12.6 | 15.3 | 18.7 | 23.0 | 28.5 | 35.3 | 44 | 22.6 | 85 |

Band# 15 18 21 24 27 30 33 36 39

Table 4-1 (Continued)

| Band Level | Band Loudness Index | | | | | | | | | Loudness | Loudness Level | |
|------------|---------------------|------|------|------|------|------|------|------|------|----------|----------------|------|
| | dB | 31.5 | 63 | 125 | 250 | 500 | 1000 | 2000 | 4000 | | | 8000 |
| 86 | 6.7 | 10.1 | 13.5 | 16.4 | 20.0 | 24.7 | 30.5 | 38 | 48 | | 24.3 | 86 |
| 87 | 7.2 | 10.9 | 14.4 | 17.5 | 21.4 | 26.5 | 32.9 | 41 | 52 | | 26.0 | 87 |
| 88 | 7.7 | 11.7 | 15.3 | 18.7 | 23.0 | 28.5 | 35.3 | 44 | 56 | | 27.9 | 88 |
| 89 | 8.2 | 12.6 | 16.4 | 20.0 | 24.7 | 30.5 | 38 | 48 | 61 | | 29.9 | 89 |
| 90 | 8.8 | 13.6 | 17.5 | 21.4 | 26.5 | 32.9 | 41 | 52 | 66 | | 32.0 | 90 |
| 91 | 9.4 | 14.8 | 18.7 | 23.0 | 28.5 | 35.3 | 44 | 56 | 71 | | 34.3 | 91 |
| 92 | 10.1 | 16.0 | 20.0 | 24.7 | 30.5 | 38 | 48 | 61 | 77 | | 36.8 | 92 |
| 93 | 10.9 | 17.3 | 21.4 | 26.5 | 32.9 | 41 | 52 | 66 | 83 | | 39.4 | 93 |
| 94 | 11.7 | 18.7 | 23.0 | 28.5 | 35.3 | 44 | 56 | 71 | 90 | | 42.2 | 94 |
| 95 | 12.6 | 20.0 | 24.7 | 30.5 | 38 | 48 | 61 | 77 | 97 | | 45.3 | 95 |
| 96 | 13.6 | 21.4 | 26.5 | 32.9 | 41 | 52 | 66 | 83 | 105 | | 48.5 | 96 |
| 97 | 14.8 | 23.0 | 28.5 | 35.3 | 44 | 56 | 71 | 90 | 113 | | 52.0 | 97 |
| 98 | 16.0 | 24.7 | 30.5 | 38 | 48 | 61 | 77 | 97 | 121 | | 55.7 | 98 |
| 99 | 17.3 | 26.5 | 32.9 | 41 | 52 | 66 | 83 | 105 | 130 | | 59.7 | 99 |
| 100 | 18.7 | 28.5 | 35.3 | 44 | 56 | 71 | 90 | 113 | 139 | | 64.0 | 100 |
| 101 | 20.3 | 30.5 | 38 | 48 | 61 | 77 | 97 | 121 | 149 | | 68.6 | 101 |
| 102 | 22.1 | 32.9 | 41 | 52 | 66 | 83 | 105 | 130 | 160 | | 73.5 | 102 |
| 103 | 24.0 | 35.3 | 44 | 56 | 71 | 90 | 113 | 139 | 171 | | 78.8 | 103 |
| 104 | 26.1 | 38 | 48 | 61 | 77 | 97 | 121 | 149 | 184 | | 84.4 | 104 |
| 105 | 28.5 | 41 | 52 | 66 | 83 | 105 | 130 | 160 | 197 | | 90.5 | 105 |
| 106 | 31.0 | 44 | 56 | 71 | 90 | 113 | 139 | 171 | 211 | | 97 | 106 |
| 107 | 33.9 | 48 | 61 | 77 | 97 | 121 | 149 | 184 | 226 | | 104 | 107 |
| 108 | 36.9 | 52 | 66 | 83 | 105 | 130 | 160 | 197 | 242 | | 111 | 108 |
| 109 | 40.3 | 56 | 71 | 90 | 113 | 139 | 171 | 211 | 260 | | 119 | 109 |
| 110 | 44 | 61 | 77 | 97 | 121 | 149 | 184 | 226 | 278 | | 128 | 110 |
| 111 | 49 | 66 | 83 | 105 | 130 | 160 | 197 | 242 | 298 | | 137 | 111 |
| 112 | 54 | 71 | 90 | 113 | 139 | 171 | 211 | 260 | 320 | | 147 | 112 |
| 113 | 59 | 77 | 97 | 121 | 149 | 184 | 226 | 278 | 343 | | 158 | 113 |
| 114 | 65 | 83 | 105 | 130 | 160 | 197 | 242 | 298 | 367 | | 169 | 114 |
| 115 | 71 | 90 | 113 | 139 | 171 | 211 | 260 | 320 | | | 181 | 115 |
| 116 | 77 | 97 | 121 | 149 | 184 | 226 | 278 | 343 | | | 194 | 116 |
| 117 | 83 | 105 | 130 | 160 | 197 | 242 | 298 | 367 | | | 208 | 117 |
| 118 | 90 | 113 | 139 | 171 | 211 | 260 | 320 | | | | 223 | 118 |
| 119 | 97 | 121 | 149 | 184 | 226 | 278 | 343 | | | | 239 | 119 |
| 120 | 105 | 130 | 160 | 197 | 242 | 298 | 367 | | | | 256 | 120 |
| 121 | 113 | 139 | 171 | 211 | 260 | 320 | | | | | 274 | 121 |
| 122 | 121 | 149 | 184 | 226 | 278 | 343 | | | | | 294 | 122 |
| 123 | 130 | 160 | 197 | 242 | 298 | 367 | | | | | 315 | 123 |
| 124 | 139 | 171 | 211 | 260 | 320 | | | | | | 338 | 124 |
| 125 | 149 | 184 | 226 | 278 | 343 | | | | | | 362 | 125 |

Band# 15 18 21 24 27 30 33 36 39

The calculated loudness is labeled sones (OD) and the loudness level is labeled phons (OD) to designate that they have been calculated from octave-band levels (O) and for a diffuse field (D).

A similar calculation can be made for third-octave bands, and they are labeled (TD).

For steady noises having a broad frequency spectrum, the loudness calculated by means of the tables, which are based on Steven's* method agrees reasonably well with direct assessments made by loudness balances against a 1000-Hz tone.

To illustrate this procedure, consider the calculations based on octave-band measurements of the noise in a factory (Table 4-2).

For a quick check to find which band contributes most to the loudness, add 3 dB to the band level in the second octave, 6 dB to the third, 9 dB to the fourth, and so on. Then the highest shifted level is usually the dominant band. This check will often be all that is needed to tell where to start in a noise-reduction program, if one doesn't have the loudness calculation charts at hand. This check is not reliable if the levels are low and the low-frequency bands dominate.

*Loc. cit.

Table 4-2

**SAMPLE BAND LEVEL-TO-LOUDNESS-
INDEX CONVERSIONS**

| Octave Band No. | Octave Band (Hz) | Band Level (dB) | Band Loudness Index |
|--------------------------------|---------------------------------|--------------------------------|------------------------------------|
| 15 | 31.5 | 78 | 4 |
| 18 | 63 | 76 | 5 |
| 21 | 125 | 78 | 8 |
| 24 | 250 | 82 | 13 |
| 27 | 500 | 81 | 14 |
| 30 | 1000 | 80 | 16 |
| 33 | 2000 | 80 | 20 |
| 36 | 4000 | 73 | 15 |
| 39 | 8000 | 65 | 11 |

$$\Sigma S = \text{Sum of Band Loudness Indexes} = 106$$

$$S_m = \text{Maximum Band Loudness Index} = 20$$

$$0.3 \Sigma S = 31.8$$

$$0.7 S_m = 14$$

$$0.3 \Sigma S + 0.7 S_m = 46 \text{ sones (OD)*}$$

$$\text{or computed loudness level} = 95 \text{ phons (OD)*}$$

*OD = Octave Diffuse (an octave-band analysis for a diffuse field).

Another and more elaborate loudness calculation procedure has been developed by Zwicker (1960) for third-octave analysis. It is not at all clear, however, that this more difficult calculation results in a calculated loudness that is in better agreement with subjective data.

Bauer and his associates (1971) have developed a simpler loudness meter that has been applied to broadcast program monitoring.

4.6 PERCEIVED LEVEL — STEVENS'S MARK VII.

As a result of his extensive review of the available evidence on "loudness," "annoyance," "noisiness," "acceptability," "objectionability," etc. of noise, Stevens (1972) has revised his earlier calculation procedure in a number of important respects.

A 1/3-octave band of noise centered at 3150 Hz is used as the reference sound instead of a 1000-Hz tone, and this sound at a level of 32 dB re 20 μPa is assigned a perceived magnitude of 1 sone.

An increase in level of 9 dB (it was 10 dB before) in the reference tone doubles the perceived magnitude in sones.

The contours of equal perceived magnitude have been modified and the masking factor in the calculation procedure now varies with level.

To calculate the perceived level and magnitude of a noise by the Mark VII procedure, proceed as follows:

1. From Table 4-3 find the proper perceived magnitude in sones for each band level.
2. From the maximum of these perceived magnitudes, S_m , find the factor, F , from Table 4-4. If octave-band levels are used, subtract 4.9 dB from the

- level of the loudest band; find the corresponding sone value; use this value for finding the factor F; double the value found in the table, and use it as F.
3. Add all the perceived magnitudes (ΣS); subtract the maximum, S_m .
 4. Multiply the sum by the factor F.
 5. Add this product to the maximum perceived magnitude, $S_t = (1 - F) \cdot S_m + F \Sigma S$. This value is the total perceived magnitude in sones.
 6. Convert this magnitude to perceived level in dB from Table 4-3 by the use of the 3150-Hz column.

This new perceived level will be about 8 dB less than that obtained for the loudness level in the Mark VI calculation procedure. This shift is a result of the use of a reference signal at 3150 Hz.

Here is a sample calculation for the factory noise used previously for the loudness calculation:

| Octave Band Center (Hz) | Band Level (dB) | Perceived Magnitude (sones) |
|--|----------------------------|--|
| 31.5 | 78 | |
| 63 | 76 | 3.2 |
| 125 | 78 | 9.5 |
| 250 | 82 | 20.2 |
| 500 | 81 | 23.5 |
| 1000 | 80 | 21.8 |
| 2000 | 80 | 29.6 |
| 4000 | 73 | 23.5 |
| 8000 | 65 | 12.7 |

$$\begin{aligned} \Sigma S &= 144.0 \\ \Sigma S - S_m &= 114.4 \\ \text{Adjusted band level} &= 80 - 4.9 = 75.1 \text{ dB} \\ \text{Corresponding perceived} \\ \text{magnitude at 2000 Hz} &= 20.4 \text{ sones} \\ 2 \times F &= 2 \times .193 = .386 \\ .386 \times 114.4 &= 44.2 \\ S_m &= 29.6 \\ S_t &= 73.8 \text{ sones} \\ \text{PL} &= 87.8 \text{ dB} \end{aligned}$$

| Band | 17 | 18 | 19 | 20 | 21 | 22 | 23 | 24 | 25 | 26-31 | 32 | 33 | 34 | 35-40 | 41 |
|-------|----|----|----|-----|-----|-----|-----|-----|-----|-------|------|------|-------|-------|--------|
| Freq. | 50 | 63 | 80 | 100 | 125 | 160 | 200 | 250 | 315 | 400- | 1600 | 2000 | 2500 | 8000 | 12,500 |
| 1 dB | | | | | | | | | | | | | | | |
| 2 | | | | | | | | | | | | | | 0.078 | |
| 3 | | | | | | | | | | | | | 0.078 | 0.087 | |
| 4 | | | | | | | | | | | | | 0.087 | 0.097 | |
| 5 | | | | | | | | | | | | | | 0.107 | |
| 6 | | | | | | | | | | | | | | 0.118 | |
| 7 | | | | | | | | | | | | | | 0.129 | |
| 8 | | | | | | | | | | | | | | 0.141 | |
| 9 | | | | | | | | | | | | | | 0.153 | |
| 10 | | | | | | | | | | | | | | 0.166 | |
| 11 | | | | | | | | | | | | | | 0.181 | 0.078 |
| 12 | | | | | | | | | | | | | | 0.196 | |
| 13 | | | | | | | | | | | | | | 0.212 | |
| 14 | | | | | | | | | | | | | | 0.228 | |
| 15 | | | | | | | | | | | | | | 0.248 | |
| 16 | | | | | | | | | | | | | | 0.269 | |
| 17 | | | | | | | | | | | | | | 0.290 | |
| 18 | | | | | | | | | | | | | | 0.314 | |
| 19 | | | | | | | | | | | | | | 0.339 | |
| 20 | | | | | | | | | | | | | | 0.367 | |
| 21 | | | | | | | | | | | | | | 0.396 | |
| 22 | | | | | | | | | | | | | | 0.428 | |
| 23 | | | | | | | | | | | | | | 0.463 | |
| 24 | | | | | | | | | | | | | | 0.500 | |
| 25 | | | | | | | | | | | | | | 0.540 | |
| 26 | | | | | | | | | | | | | | 0.583 | |
| 27 | | | | | | | | | | | | | | 0.630 | |
| 28 | | | | | | | | | | | | | | 0.680 | |
| 29 | | | | | | | | | | | | | | 0.735 | |
| 30 | | | | | | | | | | | | | | 0.794 | |
| 31 | | | | | | | | | | | | | | 0.857 | |
| 32 | | | | | | | | | | | | | | 0.926 | |
| 33 | | | | | | | | | | | | | | 1.00 | |
| 34 | | | | | | | | | | | | | | 1.08 | |
| 35 | | | | | | | | | | | | | | 1.17 | |
| 36 | | | | | | | | | | | | | | 1.26 | |
| 37 | | | | | | | | | | | | | | 1.36 | |
| 38 | | | | | | | | | | | | | | 1.47 | |
| 39 | | | | | | | | | | | | | | 1.59 | |
| 40 | | | | | | | | | | | | | | 1.72 | |
| 41 | | | | | | | | | | | | | | 1.85 | |
| 42 | | | | | | | | | | | | | | 2.00 | |
| 43 | | | | | | | | | | | | | | 2.16 | |
| 44 | | | | | | | | | | | | | | 2.33 | |
| 45 | | | | | | | | | | | | | | 2.52 | |

*From S. S. Stevens, "Perceived Level of Noise by Mark VII and Decibels (E)", *The Journal of Acoustical Society of America*, Vol. 51 No. 2 (Part 2) Feb, 1972, pp 594-596. Reprinted with permission.

Table 4-3 (Continued)
PERCEIVED MAGNITUDE IN SONES AS A FUNCTION OF BAND PRESSURE LEVEL.

| Band Freq | 26-31 | | | | | | | | | | 35-39 800M | 40 10 00L | 41 12 500 | | |
|--------------|----------|----------|----------|-----------|-----------|-----------|-----------|-----------|-----------|---------------|---------------|--------------|--------------|------------|------------|
| | 17 50 | 18 63 | 19 80 | 20 100 | 21 125 | 22 160 | 23 200 | 24 250 | 25 315 | 26-31 1250 | | | | 32 1600 | 33 2000 |
| 45 | 0.092 | 0.199 | 0.290 | 0.406 | 0.552 | 0.727 | 0.938 | 1.18 | 1.47 | 1.71 | 2.00 | 2.33 | 2.72 | 2.00 | 1.47 |
| 46 | 0.107 | 0.222 | 0.321 | 0.448 | 0.606 | 0.794 | 1.02 | 1.28 | 1.59 | 1.85 | 2.16 | 2.52 | 2.94 | 2.16 | 1.59 |
| 47 | 0.121 | 0.246 | 0.356 | 0.490 | 0.660 | 0.866 | 1.10 | 1.39 | 1.71 | 2.00 | 2.33 | 2.72 | 3.18 | 2.33 | 1.71 |
| 48 | 0.138 | 0.275 | 0.393 | 0.540 | 0.724 | 0.945 | 1.20 | 1.50 | 1.85 | 2.16 | 2.52 | 2.94 | 3.43 | 2.52 | 1.85 |
| 49 | 0.156 | 0.307 | 0.435 | 0.597 | 0.794 | 1.03 | 1.31 | 1.64 | 2.00 | 2.33 | 2.72 | 3.18 | 3.70 | 2.72 | 2.00 |
| 50 | 0.072 | 0.141 | 0.481 | 0.655 | 0.871 | 1.12 | 1.42 | 1.77 | 2.16 | 2.52 | 2.94 | 3.43 | 4.00 | 2.94 | 2.16 |
| 51 | 0.086 | 0.197 | 0.378 | 0.531 | 0.724 | 0.955 | 1.23 | 1.55 | 1.91 | 2.33 | 2.72 | 3.18 | 3.70 | 2.72 | 2.16 |
| 52 | 0.101 | 0.222 | 0.322 | 0.448 | 0.606 | 0.794 | 1.04 | 1.34 | 1.69 | 2.08 | 2.52 | 2.94 | 3.43 | 2.52 | 1.85 |
| 53 | 0.117 | 0.250 | 0.368 | 0.509 | 0.687 | 0.911 | 1.14 | 1.46 | 1.82 | 2.26 | 2.72 | 3.18 | 3.70 | 2.72 | 2.00 |
| 54 | 0.134 | 0.279 | 0.419 | 0.582 | 0.780 | 1.01 | 1.29 | 1.64 | 2.04 | 2.44 | 2.94 | 3.43 | 4.00 | 3.00 | 2.29 |
| 55 | 0.152 | 0.314 | 0.464 | 0.643 | 0.871 | 1.14 | 1.46 | 1.82 | 2.26 | 2.72 | 3.18 | 3.70 | 4.32 | 3.18 | 2.46 |
| 56 | 0.175 | 0.347 | 0.509 | 0.700 | 0.940 | 1.23 | 1.55 | 1.91 | 2.33 | 2.72 | 3.18 | 3.70 | 4.32 | 3.18 | 2.46 |
| 57 | 0.197 | 0.390 | 0.561 | 0.764 | 1.016 | 1.34 | 1.69 | 2.08 | 2.52 | 2.94 | 3.43 | 4.00 | 4.67 | 3.43 | 2.52 |
| 58 | 0.222 | 0.435 | 0.616 | 0.830 | 1.096 | 1.40 | 1.80 | 2.26 | 2.78 | 3.35 | 4.00 | 4.67 | 5.44 | 3.70 | 2.72 |
| 59 | 0.250 | 0.488 | 0.680 | 0.911 | 1.197 | 1.55 | 1.97 | 2.46 | 3.01 | 3.65 | 4.32 | 5.04 | 5.88 | 4.00 | 2.94 |
| 60 | 0.282 | 0.544 | 0.756 | 1.000 | 1.311 | 1.74 | 2.16 | 2.64 | 3.27 | 3.94 | 4.67 | 5.44 | 6.35 | 4.32 | 3.18 |
| 61 | 0.319 | 0.611 | 0.843 | 1.116 | 1.455 | 1.90 | 2.35 | 2.85 | 3.43 | 4.16 | 4.90 | 5.64 | 6.35 | 4.67 | 3.43 |
| 62 | 0.358 | 0.686 | 0.940 | 1.240 | 1.65 | 2.06 | 2.56 | 3.10 | 3.70 | 4.32 | 5.04 | 5.88 | 6.86 | 5.04 | 3.70 |
| 63 | 0.402 | 0.762 | 1.040 | 1.380 | 1.80 | 2.26 | 2.78 | 3.35 | 4.00 | 4.67 | 5.44 | 6.35 | 7.41 | 5.44 | 4.00 |
| 64 | 0.454 | 0.851 | 1.149 | 1.516 | 1.97 | 2.46 | 3.01 | 3.65 | 4.32 | 5.04 | 5.88 | 6.86 | 8.00 | 5.88 | 4.32 |
| 65 | 0.511 | 0.952 | 1.266 | 1.666 | 2.16 | 2.68 | 3.27 | 3.94 | 4.67 | 5.44 | 6.35 | 7.41 | 8.64 | 6.35 | 4.67 |
| 66 | 0.574 | 1.06 | 1.403 | 1.84 | 2.39 | 2.94 | 3.56 | 4.27 | 5.04 | 5.88 | 6.86 | 8.00 | 9.33 | 6.86 | 5.04 |
| 67 | 0.649 | 1.18 | 1.561 | 2.05 | 2.64 | 3.20 | 3.88 | 4.63 | 5.44 | 6.35 | 7.41 | 8.64 | 10.1 | 7.41 | 5.44 |
| 68 | 0.729 | 1.33 | 1.752 | 2.28 | 2.92 | 3.48 | 4.22 | 5.00 | 5.88 | 6.86 | 8.00 | 9.33 | 10.9 | 8.00 | 5.88 |
| 69 | 0.818 | 1.48 | 1.944 | 2.54 | 3.10 | 3.79 | 4.58 | 5.44 | 6.35 | 7.41 | 8.64 | 10.1 | 11.8 | 9.64 | 6.35 |
| 70 | 0.921 | 1.66 | 2.16 | 2.81 | 3.42 | 4.16 | 4.98 | 5.88 | 6.86 | 8.00 | 9.33 | 10.9 | 12.7 | 9.33 | 6.86 |
| 71 | 1.03 | 1.87 | 2.46 | 3.13 | 3.73 | 4.52 | 5.40 | 6.37 | 7.41 | 8.64 | 10.1 | 11.8 | 13.7 | 10.1 | 7.41 |
| 72 | 1.16 | 2.08 | 2.74 | 3.48 | 4.09 | 4.94 | 5.88 | 6.91 | 8.00 | 9.33 | 10.9 | 12.7 | 14.8 | 10.9 | 8.00 |
| 73 | 1.32 | 2.33 | 3.05 | 3.85 | 4.47 | 5.40 | 6.40 | 7.48 | 8.64 | 10.1 | 11.8 | 13.7 | 16.0 | 11.8 | 8.64 |
| 74 | 1.48 | 2.58 | 3.32 | 4.29 | 5.32 | 6.47 | 7.70 | 9.09 | 10.6 | 12.1 | 13.7 | 15.4 | 17.3 | 12.7 | 9.33 |
| 75 | 1.66 | 2.90 | 3.66 | 4.76 | 5.88 | 7.13 | 8.46 | 9.92 | 11.5 | 13.1 | 14.8 | 17.3 | 20.2 | 14.8 | 10.1 |
| 76 | 1.87 | 3.24 | 4.06 | 5.28 | 6.50 | 7.82 | 9.26 | 10.8 | 12.5 | 14.1 | 16.0 | 18.7 | 21.8 | 16.0 | 10.9 |
| 77 | 2.10 | 3.62 | 4.50 | 5.86 | 7.18 | 8.61 | 10.2 | 11.8 | 13.5 | 15.4 | 17.3 | 20.2 | 23.5 | 17.3 | 11.8 |
| 78 | 2.37 | 4.03 | 4.98 | 6.33 | 7.94 | 9.48 | 11.1 | 12.9 | 14.7 | 16.6 | 18.7 | 21.8 | 25.4 | 18.7 | 12.7 |
| 79 | 2.66 | 4.52 | 5.54 | 7.06 | 8.78 | 10.4 | 12.2 | 14.0 | 16.0 | 18.0 | 20.2 | 23.5 | 27.4 | 18.7 | 13.7 |
| 80 | 2.99 | 5.05 | 6.16 | 7.92 | 9.70 | 11.5 | 13.3 | 15.3 | 17.3 | 19.4 | 21.8 | 25.4 | 30.2 | 20.2 | 14.8 |
| 81 | 3.35 | 5.64 | 6.86 | 8.95 | 10.7 | 12.6 | 14.6 | 16.6 | 18.7 | 21.0 | 23.5 | 27.4 | 32.0 | 21.8 | 16.0 |
| 82 | 3.79 | 6.31 | 7.64 | 9.96 | 11.8 | 14.0 | 16.0 | 18.0 | 20.2 | 22.6 | 25.4 | 29.6 | 34.6 | 23.5 | 17.3 |
| 83 | 4.25 | 7.05 | 8.48 | 11.1 | 13.1 | 15.3 | 17.3 | 19.4 | 21.8 | 24.4 | 27.4 | 32.0 | 37.3 | 25.4 | 18.7 |
| 84 | 4.79 | 7.88 | 9.41 | 12.3 | 14.5 | 16.6 | 18.7 | 21.0 | 23.5 | 26.4 | 29.6 | 34.6 | 40.3 | 27.4 | 20.2 |

Table 4-3 (Continued)
PERCEIVED MAGNITUDE IN SONES AS A FUNCTION OF BAND PRESSURE LEVEL.

| Band Freq | 26-31 | | | | | | | | | | 35-39 | | | | | | | | | |
|--------------|----------|----------|----------|-----------|-----------|-----------|-----------|-----------|-----------|--------------|------------|------------|------------|---------------|--------------|--------------|--|--|--|--|
| | 17 50 | 18 63 | 19 80 | 20 100 | 21 125 | 22 160 | 23 200 | 24 250 | 25 315 | 400- 1250 | 32 1600 | 33 2000 | 34 2500 | 35-39 8000 | 40 10 000 | 41 12 500 | | | | |
| 85 | 5.40 | 8.81 | 13.7 | 16.0 | 18.0 | 20.2 | 22.6 | 25.4 | 28.5 | 32.0 | 37.3 | 43.5 | 50.8 | 59.3 | 43.5 | 32.0 | | | | |
| 86 | 6.06 | 9.85 | 15.2 | 17.3 | 19.4 | 21.8 | 24.4 | 27.4 | 30.8 | 34.6 | 40.3 | 47.0 | 54.9 | 64.0 | 47.0 | 34.6 | | | | |
| 87 | 6.82 | 11.0 | 16.6 | 18.7 | 21.0 | 23.5 | 26.4 | 29.6 | 33.3 | 37.3 | 43.5 | 50.8 | 59.3 | 69.1 | 50.8 | 37.3 | | | | |
| 88 | 7.68 | 12.3 | 18.0 | 20.2 | 22.6 | 25.4 | 28.5 | 32.0 | 35.9 | 40.3 | 47.0 | 54.9 | 64.0 | 74.7 | 54.9 | 40.3 | | | | |
| 89 | 8.64 | 13.8 | 19.4 | 21.8 | 24.4 | 27.4 | 30.8 | 34.6 | 38.8 | 43.5 | 50.8 | 59.3 | 69.1 | 80.6 | 59.3 | 43.5 | | | | |
| 90 | 9.71 | 15.4 | 21.0 | 23.5 | 26.4 | 29.6 | 33.3 | 37.3 | 41.9 | 47.0 | 54.9 | 64.0 | 74.7 | 87.1 | 64.0 | 47.0 | | | | |
| 91 | 10.9 | 16.8 | 22.6 | 25.4 | 28.5 | 32.0 | 35.9 | 40.3 | 45.2 | 50.8 | 59.3 | 69.1 | 80.6 | 94.1 | 69.1 | 50.8 | | | | |
| 92 | 12.3 | 18.3 | 24.4 | 27.4 | 30.8 | 34.6 | 38.8 | 43.5 | 48.9 | 54.9 | 64.0 | 74.7 | 87.1 | 102 | 74.7 | 54.9 | | | | |
| 93 | 13.8 | 19.8 | 26.4 | 29.6 | 33.3 | 37.3 | 41.9 | 47.0 | 52.8 | 59.3 | 69.1 | 80.6 | 94.1 | 110 | 80.6 | 59.3 | | | | |
| 94 | 15.6 | 21.5 | 28.5 | 32.0 | 35.9 | 40.3 | 45.2 | 50.8 | 57.1 | 64.0 | 74.7 | 87.1 | 102 | 119 | 87.1 | 64.0 | | | | |
| 95 | 17.1 | 23.3 | 30.8 | 34.6 | 38.8 | 43.5 | 48.9 | 54.9 | 61.6 | 69.1 | 80.6 | 94.1 | 110 | 128 | 94.1 | 69.1 | | | | |
| 96 | 18.6 | 25.3 | 33.3 | 37.3 | 41.9 | 47.0 | 52.8 | 59.3 | 66.6 | 74.7 | 87.1 | 102 | 119 | 138 | 102 | 74.7 | | | | |
| 97 | 20.3 | 27.4 | 35.9 | 40.3 | 45.2 | 50.8 | 57.1 | 64.0 | 71.9 | 80.6 | 94.1 | 110 | 128 | 149 | 110 | 80.6 | | | | |
| 98 | 22.1 | 29.8 | 38.8 | 43.5 | 48.9 | 54.9 | 61.6 | 69.1 | 77.6 | 87.1 | 102 | 119 | 138 | 161 | 119 | 87.1 | | | | |
| 99 | 24.1 | 32.3 | 41.9 | 47.0 | 52.8 | 59.3 | 66.6 | 74.7 | 83.8 | 94.1 | 110 | 128 | 149 | 174 | 128 | 94.1 | | | | |
| 100 | 26.3 | 35.1 | 45.3 | 50.8 | 57.1 | 64.0 | 71.9 | 80.6 | 90.6 | 102 | 119 | 138 | 161 | 188 | 138 | 102 | | | | |
| 101 | 28.6 | 38.0 | 48.9 | 54.9 | 61.6 | 69.1 | 77.6 | 87.1 | 98.0 | 110 | 128 | 149 | 174 | 203 | 149 | 110 | | | | |
| 102 | 31.2 | 41.2 | 52.8 | 59.3 | 66.6 | 74.7 | 83.8 | 94.1 | 106 | 119 | 138 | 161 | 188 | 219 | 161 | 119 | | | | |
| 103 | 34.0 | 44.7 | 57.0 | 64.0 | 71.9 | 80.6 | 90.6 | 102 | 114 | 128 | 149 | 174 | 203 | 237 | 174 | 128 | | | | |
| 104 | 37.0 | 48.5 | 61.6 | 69.1 | 77.6 | 87.1 | 98.0 | 110 | 124 | 138 | 161 | 188 | 219 | 256 | 188 | 138 | | | | |
| 105 | 40.4 | 52.4 | 66.5 | 74.7 | 83.8 | 94.1 | 106 | 119 | 133 | 149 | 174 | 203 | 237 | 276 | 203 | 149 | | | | |
| 106 | 44.0 | 57.0 | 71.8 | 80.6 | 90.6 | 102 | 114 | 128 | 144 | 161 | 188 | 219 | 256 | 299 | 219 | 161 | | | | |
| 107 | 48.0 | 61.8 | 77.6 | 87.1 | 98.0 | 110 | 124 | 138 | 155 | 174 | 203 | 237 | 276 | 323 | 237 | 174 | | | | |
| 108 | 52.3 | 67.1 | 83.8 | 94.1 | 106 | 119 | 133 | 149 | 168 | 188 | 219 | 256 | 299 | 348 | 256 | 188 | | | | |
| 109 | 57.0 | 72.8 | 90.5 | 102 | 114 | 128 | 144 | 161 | 184 | 203 | 237 | 276 | 323 | 376 | 276 | 203 | | | | |
| 110 | 62.1 | 78.9 | 97.8 | 110 | 124 | 138 | 155 | 174 | 196 | 219 | 256 | 299 | 348 | 406 | 299 | 219 | | | | |
| 111 | 67.5 | 85.6 | 106 | 119 | 133 | 149 | 168 | 188 | 211 | 237 | 276 | 323 | 376 | 439 | 323 | 237 | | | | |
| 112 | 73.8 | 92.9 | 114 | 128 | 144 | 161 | 181 | 203 | 228 | 256 | 299 | 348 | 406 | 474 | 348 | 256 | | | | |
| 113 | 80.5 | 101 | 123 | 138 | 155 | 174 | 196 | 219 | 246 | 276 | 323 | 376 | 439 | 512 | 376 | 276 | | | | |
| 114 | 87.8 | 109 | 133 | 149 | 168 | 188 | 211 | 237 | 266 | 299 | 348 | 406 | 474 | 553 | 406 | 299 | | | | |
| 115 | 95.6 | 119 | 144 | 161 | 181 | 203 | 228 | 256 | 288 | 323 | 376 | 439 | 512 | 597 | 439 | 323 | | | | |
| 116 | 104 | 129 | 155 | 174 | 196 | 219 | 246 | 276 | 311 | 348 | 406 | 474 | 553 | 645 | 474 | 348 | | | | |
| 117 | 114 | 139 | 168 | 188 | 211 | 237 | 266 | 299 | 336 | 376 | 439 | 512 | 597 | 697 | 512 | 376 | | | | |
| 118 | 124 | 152 | 181 | 203 | 228 | 256 | 288 | 323 | 362 | 406 | 474 | 553 | 645 | 752 | 553 | 406 | | | | |
| 119 | 135 | 164 | 196 | 219 | 246 | 276 | 311 | 348 | 391 | 439 | 512 | 597 | 697 | 813 | 597 | 439 | | | | |
| 120 | 147 | 178 | 211 | 237 | 266 | 299 | 336 | 376 | 422 | 474 | 553 | 645 | 752 | 878 | 645 | 474 | | | | |
| 121 | 160 | 193 | 228 | 256 | 288 | 323 | 362 | 406 | 456 | 512 | 597 | 697 | 813 | 948 | 697 | 512 | | | | |
| 122 | 175 | 209 | 246 | 276 | 311 | 348 | 391 | 439 | 493 | 553 | 645 | 752 | 878 | 1024 | 752 | 553 | | | | |
| 123 | 190 | 227 | 266 | 299 | 336 | 376 | 422 | 474 | 532 | 597 | 697 | 813 | 948 | 1106 | 813 | 597 | | | | |
| 124 | 207 | 246 | 287 | 323 | 362 | 406 | 456 | 512 | 575 | 645 | 752 | 878 | 1024 | 1194 | 878 | 645 | | | | |

Table 4-4*†
F vs SONES IN ONE-THIRD O.B.

| Sones | F | Sones | F |
|-------|-------|-------|-------|
| 0.181 | 0.10 | 8.64 | 0.230 |
| 0.196 | 0.122 | 9.33 | 0.226 |
| 0.212 | 0.140 | 10.1 | 0.222 |
| 0.230 | 0.158 | 10.9 | 0.217 |
| 0.248 | 0.174 | 11.8 | 0.212 |
| 0.269 | 0.187 | 12.7 | 0.208 |
| 0.290 | 0.200 | 13.7 | 0.204 |
| 0.314 | 0.212 | 14.8 | 0.200 |
| 0.339 | 0.222 | 16.0 | 0.197 |
| 0.367 | 0.232 | 17.3 | 0.195 |
| 0.396 | 0.241 | 18.7 | 0.194 |
| 0.428 | 0.250 | 20.2 | 0.193 |
| 0.463 | 0.259 | 21.8 | 0.192 |
| 0.500 | 0.267 | 23.5 | 0.191 |
| 0.540 | 0.274 | 25.4 | 0.190 |
| 0.583 | 0.281 | 27.4 | 0.190 |
| 0.630 | 0.287 | 29.6 | 0.190 |
| 0.680 | 0.293 | 32.0 | 0.190 |
| 0.735 | 0.298 | 34.6 | 0.190 |
| 0.794 | 0.303 | 37.3 | 0.190 |
| 0.857 | 0.308 | 40.3 | 0.191 |
| 0.926 | 0.312 | 43.5 | 0.191 |
| 1.00 | 0.316 | 47.0 | 0.192 |
| 1.08 | 0.319 | 50.8 | 0.193 |
| 1.17 | 0.320 | 54.9 | 0.194 |
| 1.26 | 0.322 | 59.3 | 0.195 |
| 1.36 | 0.322 | 64.0 | 0.197 |
| 1.47 | 0.320 | 69.1 | 0.199 |
| 1.59 | 0.319 | 74.7 | 0.201 |
| 1.72 | 0.317 | 80.6 | 0.203 |
| 1.85 | 0.314 | 87.1 | 0.205 |
| 2.00 | 0.311 | 94.1 | 0.208 |
| 2.16 | 0.308 | 102 | 0.210 |
| 2.33 | 0.304 | 110 | 0.212 |
| 2.52 | 0.300 | 119 | 0.215 |
| 2.72 | 0.296 | 128 | 0.217 |
| 2.94 | 0.292 | 138 | 0.219 |
| 3.18 | 0.288 | 149 | 0.221 |
| 3.43 | 0.284 | 161 | 0.223 |
| 3.70 | 0.279 | 174 | 0.224 |
| 4.00 | 0.275 | 188 | 0.225 |
| 4.32 | 0.270 | 203 | 0.226 |
| 4.67 | 0.266 | 219 | 0.227 |
| 5.04 | 0.262 | 237 | 0.227 |
| 5.44 | 0.258 | 256 | 0.227 |
| 5.88 | 0.253 | . | . |
| 6.35 | 0.248 | . | . |
| 6.86 | 0.244 | . | . |
| 7.41 | 0.240 | . | . |
| 8.00 | 0.235 | . | . |

*The factor *F* is a function of the number of sones in the 1/3-octave band that is maximally loud or noisy. The value of *F* remains constant above 219 sones.

†From S.S. Stevens, "Perceived Level of Noise by Mark VII and Decibels (E)," *The Journal of Acoustical Society of America*, Vol. 51, No. 2 (Part 2) Feb. 1972, p. 597. Reprinted with permission.

4.7 EFFECT OF TONAL COMPONENTS.

When a noise is a mixture of random noise and audible tonal components, the loudness or annoyance may be somewhat greater than expected from the direct analysis and calculation schemes (Kryter and Pearsons, 1963; Wells, 1969). The effect is usually taken into account by a correction of the calculated level, but it normally requires a detailed analysis of the sound at least equivalent to that of a third-octave analysis.

4.8 EFFECT OF DURATION.

If we are talking with someone and we are interrupted by a noise that interferes seriously with speech, it is more annoying if it lasts for a long time than if it is very brief. In order to take this effect into account a number of procedures have been suggested (Pietrasanta and Stevens, 1958; Young, 1968; Kryter, 1968). Most of them are, in effect, an integration (on a power basis) of the loudness, perceived noise, or A-weighted sound pressure over time. These procedures are still not well validated. Some qualifying term, for example, "Effective Perceived Noise Level" is often used to indicate that a correction for duration has been made. Such a correction is shown in the next section.

Another measure that includes duration is described in the section on sound exposure level (Section 4.17).

The importance of duration of a noise exposure as well as the level of the noise has been well demonstrated in the effects of noise exposure in causing hearing damage. This effect is described in detail in Chapter 3.

Although annoyance generally tends to increase as a sound persists, loudness under some conditions decreases with increasing duration after it has persisted for about a second (Scharf, 1978).

◆ 4.9 PERCEIVED-NOISE LEVEL.

Kryter (1970) and his co-workers (Kryter and Pearsons, 1963) have followed a procedure similar to that used for loudness, but they asked the observer to compare noises on the basis of their acceptability or their "noisiness." The resulting judgments were found to be similar to those for loudness, but enough difference was noticed to give a somewhat different rating for various sounds. On the basis of these results, Kryter set up a calculation procedure for "perceived noise level," PNL in dB, also called "PNdB." The corresponding "noisiness" is given in units called "noys."

Ratings in terms of perceived noise level are now widely used for aircraft noise, particularly for aircraft flying overhead. The calculations for aircraft noise are based on levels in third-octave bands and the detailed procedures used are given in FAA regulations and in ISO recommendations.

A number of versions of the perceived-noise-level-calculation procedure have been proposed. But the one most widely accepted as defining perceived noise level is that given by the Federal Aviation Administration in its Federal Aviation Regulations, Part 36. The appendix that describes the calculation procedure is reproduced here for reference.

APPENDIX B — AIRCRAFT NOISE EVALUATION UNDER § 36.103

Sec.

B36.1 *General*

B36.3 *Perceived noise level.*

B36.5 *Correction for spectral irregularities.*

B36.7 *Maximum tone corrected perceived noise level.*

B36.9 *Duration correction.*

B36.11 *Effective perceived noise level.*

B36.13 *Mathematical formulation of noy tables.*

Section B36.1 *General.* The procedures in this appendix must be used to determine the noise evaluation quantity designated as effective perceived noise level, EPNL, under §36.103. These procedures, which use the physical properties of noise measured as prescribed by Appendix A of this part, consist of the following:

(a) The 24 one-third octave bands of sound pressure level are converted to perceived noisiness by means of a noy table. The noy values are combined and then converted to instantaneous perceived noise levels, PNL(k).

(b) A tone correction factor, C(k), is calculated for each spectrum to account for the subjective response to the presence of the maximum tone.

(c) The tone correction factor is added to the perceived noise level to obtain tone corrected perceived noise levels, PNLT(k), at each one-half second increment of time. The instantaneous values of tone corrected perceived noise level are noted with respect to time and the maximum value, PNLTM, is determined.

$$\text{PNLT}(k) = \text{PNL}(k) + C(k)$$

(d) A duration correction factor, D, is computed by integration under the curve of tone corrected perceived noise level versus time.

(e) Effective perceived noise level, EPNL, is determined by the algebraic sum of the maximum tone corrected perceived noise level and the duration correction factor.

$$\text{EPNL} = \text{PNLTM} + D$$

Section B36.3 *Perceived noise level.* Instantaneous perceived noise levels, PNL(k), must be calculated from instantaneous one-third octave band sound pressure levels, SPL(i,k), as follows:

(a) *Step 1.* Convert each one-third octave band SPL(i,k), from 50 to 10,000 Hz, to perceived noisiness, n(i,k), by reference to Table B1, or to the mathematical formulation of the noy table given in §B36.13 of this appendix.

(b) *Step 2.* Combine the perceived noisiness values, n(i,k), found in step 1 by the following formula:

$$\begin{aligned} N(k) &= n(k) + 0.15 \left[\sum_{i=1}^{24} n(i,k) \right] - n(k) \\ &= 0.85n(k) + 0.15 \sum_{i=1}^{24} n(i,k) \end{aligned}$$

where n(k) is the largest of the 24 values of n(i,k) and N(k) is the total perceived noisiness.

(c) *Step 3.* Convert the total perceived noisiness, N(k), into perceived noise level, PNL(k), by the following formula:

$$\text{PNL}(k) = 40.0 + 33.22 \log N(k)$$

which is plotted in Figure B1. PNL(k) may also be obtained by choosing N(k) in the 1,000 Hz column of Table B1 and then reading the corresponding value of SPL(i,k) which, at 1,000 Hz, equals PNL(k).

[Section B36.2 of Appendix 8 amended to redesignate it as Section B36.3; redesignate steps 1, 2, and 3, as paragraphs (a), (b), and (c) respectively; and further revise steps 1 and 3 at 43 FR 8731, March 2, 1978, effective April 3, 1978]

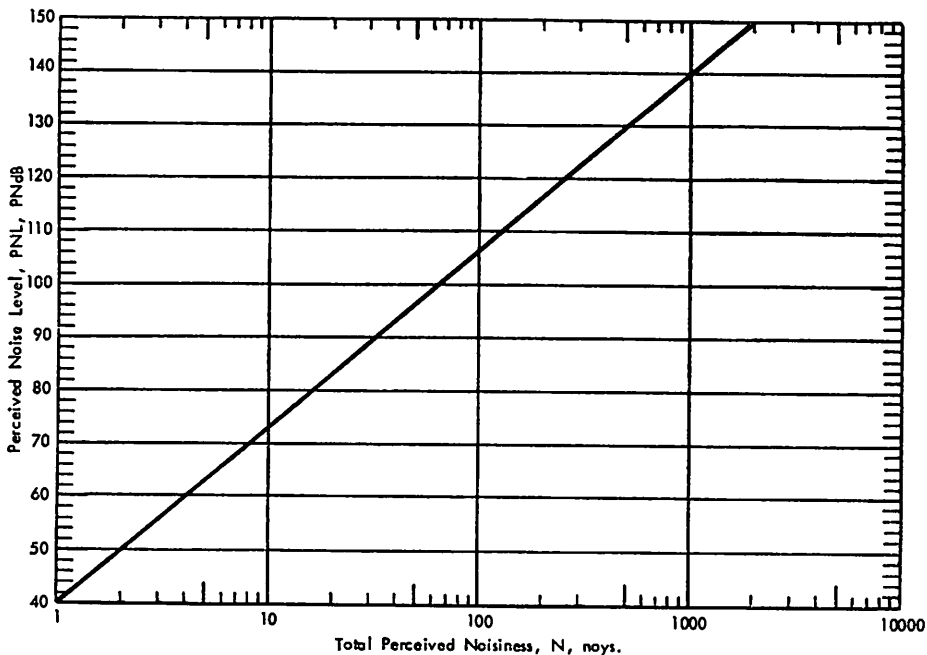

Figure B1. Perceived Noise Level as a Function of Noys.

Section B36.5 *Correction for spectral irregularities*. Noise having pronounced irregularities in the spectrum (for example, discrete frequency components or tones), must be adjusted by the correction factor $C(k)$ calculated as follows:

(a) *Step 1*. Starting with the corrected sound pressure level in the 80 Hz one-third octave band (band number 3), calculate the changes in sound pressure level (or "slopes") in the remainder of the one-third octave band as follows:

$$\begin{aligned}
 s(3,k) &= \text{no value} \\
 s(4,k) &= \text{SPL}(4,k) - \text{SPL}(3,k) \\
 &\vdots \\
 &\vdots \\
 s(i,k) &= \text{SPL}(i,k) - \text{SPL}[(i-1),k] \\
 &\vdots \\
 &\vdots \\
 s(24,k) &= \text{SPL}(24,k) - \text{SPL}(23,k)
 \end{aligned}$$

(b) *Step 2*. Encircle the value of the slope, $s(i,k)$, where the absolute value of the change in slope is greater than 5; that is, where $|\Delta s(i,k)| = |s(i,k) - s[(i-1),k]| > 5$.

(c) *Step 3*. (1) If the encircled value of the slope $s(i,k)$ is positive and algebraically greater than the slope $s[(i-1),k]$, encircle $\text{SPL}(i,k)$.

(2) If the encircled value of the slope $s(i,k)$ is zero or negative and the slope $s[(i-1),k]$ is positive, encircle $\text{SPL}[(i-1),k]$.

(3) For all other cases, no sound pressure level value is to be encircled.

(d) *Step 4*. Omit all $\text{SPL}(i,k)$ encircled in Step 3 and compute new sound pressure levels $\text{SPL}'(i,k)$ as follows:

(1) For nonencircled sound pressure levels, let the new sound pressure levels equal the original sound pressure levels,
 $\text{SPL}'(i,k) = \text{SPL}(i,k)$

(2) For encircled sound pressure levels in bands 1-23, let the new sound pressure level equal the arithmetic average of the preceding and following sound pressure levels,

$$SPL'(i,k) = (\frac{1}{2})(SPL[(i-1),k] + SPL[(i+1),k])$$

(3) If the sound pressure level in the highest frequency band (i=24) is encircled, let the new sound pressure level in that band equal

$$SPL'(24,k) = SPL(23,k) + s(23,k).$$

(e) *Step 5.* Recompute new slopes $s'(i,k)$, including one for an imaginary 25th band, as follows:

$$s'(3,k) = s'(4,k)$$

$$s'(4,k) = SPL'(4,k) - SPL'(3,k)$$

.

.

$$s'(i,k) = SPL'(i,k) - SPL'[(i-1),k]$$

.

.

$$s'(24,k) = SPL'(24,k) - SPL'(23,k)$$

$$s'(25,k) = s'(24,k)$$

(f) *Step 6.* For i from 3 to 23, compute the arithmetic average of the three adjacent slopes as follows:

$$\bar{s}(i,k) = (\frac{1}{3})[s'(i,k) + s'[(i+1),k] + s'[(i+2),k]]$$

(g) *Step 7.* Compute final adjusted one-third octave-band sound pressure levels, $SPL''(i,k)$, by beginning with band number 3 and proceeding to band number 24 as follows:

$$SPL''(3,k) = SPL(3,k)$$

$$SPL''(4,k) = SPL''(3,k) + \bar{s}(3,k)$$

.

.

$$SPL''(i,k) = SPL''[(i-1),k] + \bar{s}[(i-1),k]$$

.

.

$$SPL''(24,k) = SPL''(23,k) + \bar{s}(23,k)$$

(h) *Step 8.* Calculate the differences, $F(i,k)$, between the original and the adjusted sound pressure levels as follows:

$$F(i,k) = SPL(i,k) - SPL''(i,k)$$

and note only values greater than zero.

(i) *Step 9.* For each of the 24 one-third octave bands, determine tone correction factors from the sound pressure level differences $F(i,k)$ and Table B2.

(j) *Step 10.* Designate the largest of the tone correction factors, determined in Step 9, as $C(k)$. An example of the tone correction procedure is given in Table B3.

(k) Tone corrected perceived noise levels $PNLT(k)$ are determined by adding the $C(k)$ values to corresponding $PNL(k)$ values, that is,

$$PNLT(k) = PNL(k) + C(k)$$

(l) For any i -th one-third octave band, at any k -th increment of time, for which the tone correction factor is suspected to result from something other than (or in addition to) an actual tone (or any spectral irregularity other than aircraft noise), an additional analysis may be made using a filter with a bandwidth narrower than one-third of an octave. If the narrow band analysis corroborates that suspicion, then a revised value for the background sound pressure level, $SPL^*(i,k)$, may be determined from the analysis and used to compute a revised tone correction factor, $F(i,k)$, for that particular one-third octave band.

(m) Tones resulting from ground-plane reflections in the 800 Hz and lower one-third octave bands may be excluded from the calculation of corrections for spectral irregularities. To qualify for this exclusion, the pseudotones must be clearly identified as not being related to the engine noise. This identification may be made either by comparing measured data with data from a flush mounted microphone, or by observing the Doppler shift characteristics of the tone during the flyover-noise/time history. Since pseudotones are related to ground reflections, a microphone mounted flush to the ground will yield a spectral shape which can be distinguished from that produced by the 4-foot high microphone at those frequencies which can be related to ground reflection's geometrical relationships. Identification through Doppler shifting (the symmetric variation of frequency with time) can be made because the Doppler frequency variation yields a frequency increase for an approaching signal and a frequency decrease for a receding signal. Pseudotones at frequencies above 800 Hz generally should not yield significant tone corrections. However, for consistency, each tone correction value must be included in the computation for spectral irregularities. While the tone corrections below 800 Hz may be ignored for the spectral irregularity correction, the SPL values must be included in the noy calculation prescribed in §B36.13 of this appendix.

(n) After the value of PNLTM for each flyover-noise/time history, is identified, the frequency for the largest tone correction factor ($C[k]$) must be identified for the two preceding and the two succeeding, 500-millisecond time intervals, to identify possible tone suppression at PNLTM as a result of band sharing of the tone. If the value of $C(k)$ for PNLTM is less than the average value of $C(k)$ for those five consecutive time intervals, that average value of $C(k)$ must be used to compute a new value for PNLTM.

[Section B36.3 of Appendix B amended to redesignate it as Section B36.5; redesignate steps 1 through 10 as paragraphs (a) through (j) respectively; amend steps 3 and 4; designate undesignated paragraphs as paragraphs (k) and (l); and add paragraphs (m) and (n) at 43 FR 8731, March 2, 1978, effective April 3, 1978]

Section B36.7 *Maximum tone corrected perceived noise level.* (a) The maximum tone corrected perceived noise level, PNLTM, is the maximum calculated value of the tone corrected perceived noise level, PNLTK, calculated in accordance with the procedure of § B36.5 of this Appendix. Figure B2 is an example of a flyover noise time history where the maximum value is clearly indicated. Half-second time intervals, Δt , are small enough to obtain a satisfactory noise time history.

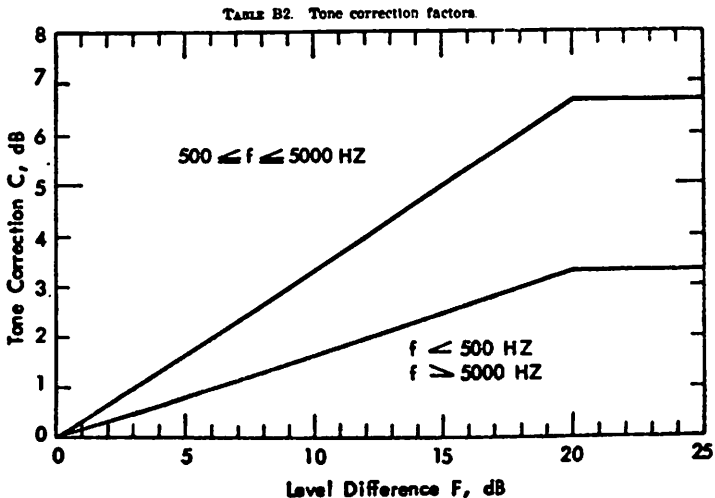

| Frequency f , HZ | Level Difference F , dB | Tone Correction C , dB |
|-----------------------|---------------------------------|--------------------------------|
| $50 \leq f < 500$ | $0 \leq F < 20$ $20 \leq F$ | $F/6$ $3 \frac{1}{3}$ |
| $500 \leq f < 5000$ | $0 \leq F < 20$ $20 \leq F$ | $F/3$ $6 \frac{2}{3}$ |
| $5000 \leq f < 10000$ | $0 \leq F < 20$ $20 \leq F$ | $F/6$ $3 \frac{1}{3}$ |

[Table B-2 amended at 43 FR 8731, March 2, 1978, effective April 3, 1978]

TABLE B3. Example of tone correction calculation for a turbofan engine.

| ① | ② | ③ | ④ | ⑤ | ⑥ | ⑦ | ⑧ | ⑨ | ⑩ | ⑪ |
|-------------|-----------|-----------|----------------------|------------------------|-------------------------|-------------------------------------|------------------------------|--------------------------|----------------------|----------------------|
| Band (i) | f HZ | SPL dB | S dB Step 1 | ΔS1 dB Step 2 | SPL' dB Step 4 | S' dB, Step 5 _i | \bar{S} dB Step 6 | SPL'' dB Step 7 | F dB Step 8 | C dB Step 9 |
| 1 | 50 | - | - | - | - | - | - | - | - | - |
| 2 | 63 | - | - | - | - | - | - | - | - | - |
| 3 | 80 | 70 | - | - | 70 | -8 | -2 1/3 | 70 | - | - |
| 4 | 100 | 62 | -6 | - | 62 | -8 | +3 1/3 | 67 2/3 | - | - |
| 5 | 125 | (70) | +8 | 16 | 71 | +9 | +6 2/3 | 71 | - | - |
| 6 | 160 | 80 | +10 | 2 | 80 | +9 | +2 2/3 | 77 2/3 | 2 1/3 | 1/3 |
| 7 | 200 | 82 | +2 | 8 | 82 | +2 | -1 1/3 | 80 1/3 | 1 2/3 | 1/3 |
| 8 | 250 | (83) | +1 | 1 | 79 | -3 | -1 1/3 | 79 | 4 | 2/3 |
| 9 | 315 | 76 | -7 | 8 | 76 | -3 | +1 1/3 | 77 2/3 | - | - |
| 10 | 400 | (60) | +4 | 11 | 78 | +2 | +1 | 78 | 2 | 1/3 |
| 11 | 500 | 80 | 0 | 4 | 80 | +2 | 0 | 79 | 1 | 1/3 |
| 12 | 630 | 79 | -1 | 1 | 79 | -1 | 0 | 79 | - | - |
| 13 | 800 | 78 | -1 | 0 | 78 | -1 | -1/3 | 79 | -1 | - |
| 14 | 1000 | 80 | +2 | 3 | 80 | +2 | -2/3 | 78 2/3 | 1 1/3 | 1/3 |
| 15 | 1250 | 78 | -2 | 4 | 78 | -2 | -1/3 | 78 | - | - |
| 16 | 1600 | 76 | -2 | 0 | 76 | -2 | +1/3 | 77 2/3 | - | - |
| 17 | 2000 | 79 | +3 | 5 | 79 | +3 | +1 | 78 | 1 | 1/3 |
| 18 | 2500 | (85) | +6 | 3 | 79 | 0 | -1/3 | 79 | 6 | [2] |
| 19 | 3150 | 79 | -(6) | 12 | 79 | 0 | -2 2/3 | 78 2/3 | 1/3 | 0 |
| 20 | 4000 | 78 | -1 | 5 | 78 | -1 | -6 1/3 | 76 | 2 | 2/3 |
| 21 | 5000 | 71 | -(7) | 6 | 71 | -7 | -8 | 69 2/3 | 1 1/3 | 1/3 |
| 22 | 6300 | 60 | -11 | 4 | 60 | -11 | -8 2/3 | 61 2/3 | - | - |
| 23 | 8000 | 54 | -6 | 5 | 54 | -6 | -8 | 53 | 1 | 0 |
| 24 | 10000 | 45 | -9 | 3 | 45 | -9 | - | 45 | - | - |

| | |
|--------|------------------|
| Step 1 | ③ (i) - ③ (i-1) |
| Step 2 | ④ (i) - ④ (i-1) |
| Step 3 | see instructions |
| Step 4 | see instructions |
| Step 5 | ⑥ (i) - ⑥ (i-1) |

| | |
|--------|---------------------------------|
| Step 6 | [⑦ (i) + ⑦ (i+1) + ⑦ (i+2)] ÷ 3 |
| Step 7 | ⑨ (i-1) + ⑧ (i-1) |
| Step 8 | ③ (i) - ⑨ (i) |
| Step 9 | see Table B2 |

[Table B3 amended at 43 FR 8731, March 2, 1978, effective April 3, 1978]

(b) If there are no pronounced irregularities in the spectrum, then the procedure of § B36.5 of this Appendix would be redundant since $PNLT(k)$ would be identically equal to $PNLTM$. For this case, $PNLTM$ would be the maximum value of $PNLT(k)$ and would equal $PNLTM$.

[Section B36.4 of Appendix B amended to redesignate it as B36.7; designate the undesignated paragraphs as paragraphs (a) and (b); and further revise those paragraphs at 43 FR 8731, March 2, 1978, effective April 3, 1978]

Section B36.9 *Duration correction.* (a) the duration correction factor D is determined by the integration technique defined by the expression:

$$D = 10 \log \left[\left(\frac{1}{T} \int_{t(1)}^{t(2)} \text{ant} [PNLT/10] dt \right) - PNLTM \right]$$

where T is a normalizing time constant, $PNLTM$ is the maximum value of $PNLT$, and $t(1)$ and $t(2)$ are the limits of the significant noise time history.

(b) Since $PNLT$ is calculated from measured values of SPL , there will, in general, be no obvious equation for $PNLT$ as a function of time. Consequently, the equation can be rewritten with a summation sign instead of an integral sign as follows:

$$D = 10 \log \left[\left(\frac{1}{T} \sum_{k=0}^{2d/\Delta t} \Delta t \text{ant} [PNLT(k)/10] \right) - PNLTM \right]$$

where Δt is the length of the equal increments of time for which $PNLT(k)$ is calculated and d is the time interval to the nearest 1.0 second during which $PNLT(k)$ is within a specified value, h , of $PNLTM$.

(c) Half-second time intervals for Δt are small enough to obtain a satisfactory history of the perceived noise level. A shorter time interval may be selected by the applicant provided approved limits and constants are used.

(d) The following values for T , Δt , and h , must be used in calculating D :

- $T = 10 \text{ sec.}$
- $\Delta t = 0.5 \text{ sec., and}$
- $h = 10 \text{ dB}$

Using the above values, the equation for D becomes

$$D = 10 \log \left[\sum_{k=0}^{2d} \text{ant} [PNLT(k)/10] \right] - PNLTM - 13$$

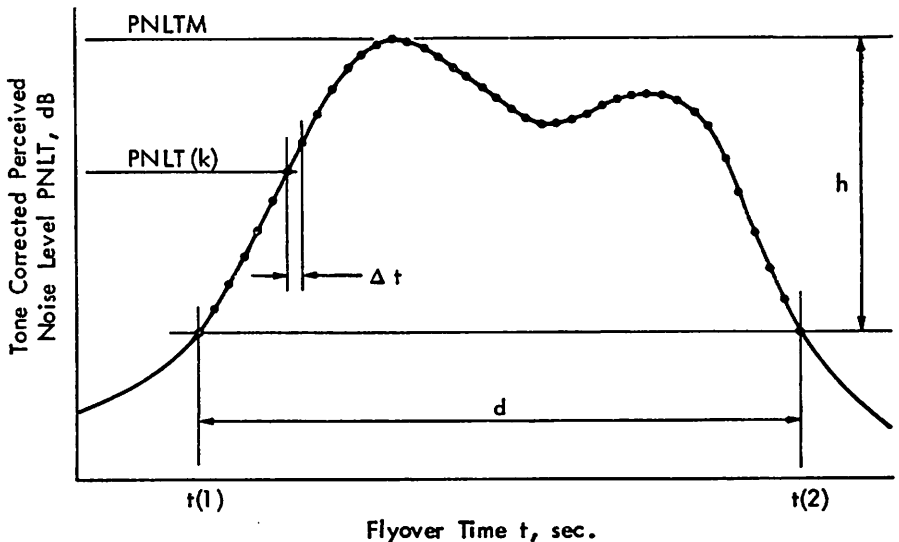

Figure B2. Example of Perceived Noise Level Corrected for Tones as a Function of Aircraft Flyover Time

where the integer d is the duration time defined by the points that are 10 dB less than PNLTM.

(e) If the 10 dB-down points fall between calculated PNL(k) values (the usual case), the applicable limits for the duration time must be chosen from the PNL(k) values closest to PNLTM-10. For those cases with more than one peak value of PNL(k), the applicable limits must be chosen to yield the largest possible value for the duration time.

(f) If the value of PNL(k) at the 10 dB-down points is 90 PNdB or less, the value of d may be taken as the time interval between the initial and the final times for which PNL(k) equals 90 PNdB, except that, for applications made after September 17, 1971, the aircraft testing procedures must include the 10 dB-down points in the flyover noise/time record. [B36.5 amended at 41 FR 35058, August 19, 1976; Section B36.5 amended to redesignate it as Section B36.9 and to designate the paragraphs as (a) through (f) at 43 FR 8731, March 2, 1978, effective April 3, 1978]

Section B36.11 *Effective perceived noise level.* (a) The total subjective effect of an aircraft flyover is designated "effective perceived noise level," EPNL, and is equal to the algebraic sum of the maximum value of the tone corrected perceived noise level, PNLTM, and the duration correction, D. That is,

$$EPNL = PNLTM + D$$

Where PNLTM and D are calculated under §§B36.7 and B36.9 of this appendix.

(b) The above equation can be rewritten by substituting the equation for D from §B36.9 of this appendix, that is,

$$EPNL = 10 \log \left[\sum_{k=0}^{3d} \text{ant}[\text{PNLT}(k)/10] \right] - 13$$

[Section B36.6 of Appendix B is amended to redesignate it as Section B36.11; designate the two undesignated paragraphs as paragraphs (a) and (b); and amend those two paragraphs at 4 FR 8731, March 2, 1978, effective April 3, 1978]

Section B36.13 *Mathematical formulation of noise tables.* (a) The relationship between sound pressure level and perceived noisiness given in Table B1 is illustrated in Figure B3. The variation of SPL with log n for a given one-third octave band can be expressed by either one or two straight lines depending upon the frequency range. Figure B3(a) illustrates the double line case for frequencies below 400 Hz, and above 6,300 Hz and Figure B3(b) illustrates the single line case for all other frequencies.

(b) The important aspects of the mathematical formulation are:

1. the slopes of the straight lines, p(b) and p(c),
2. the intercepts of the lines on the SPL-axis, SPL(b), and SPL(c), and
3. The coordinates of the discontinuity, SPL(a), and log n(a).

(c) The equations are as follows:

Case 1. Figure B3(a), $f < 400$ Hz.
 $f > 6300$ Hz

$$SPL(a) = \frac{p(c)SPL(b) - p(b)SPL(c)}{p(c) - p(b)}$$

$$\log n(a) = \frac{SPL(c) - SPL(b)}{p(b) - p(c)}$$

(a) $SPL(b) \leq SPL \leq SPL(a)$.

$$n = \text{ant} \frac{SPL - SPL(b)}{p(b)}$$

(b) $SPL \geq SPL(a)$.

$$n = \text{ant} \frac{SPL - SPL(c)}{p(c)}$$

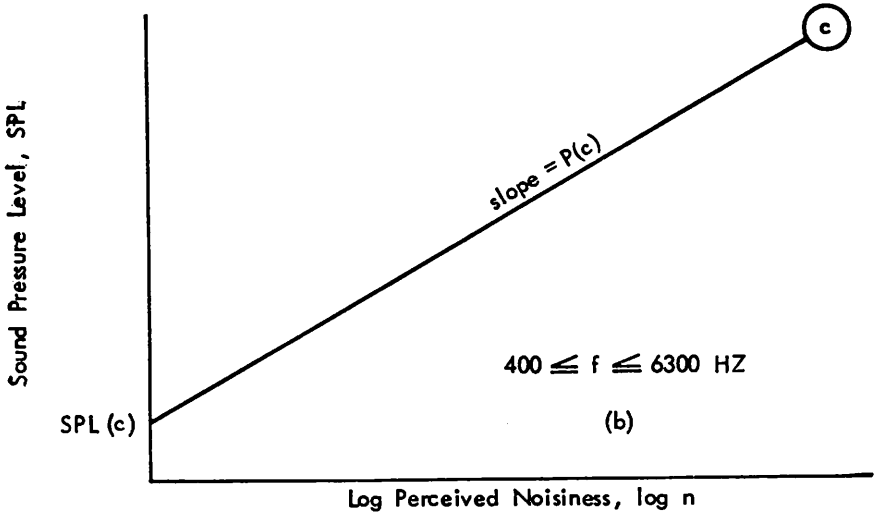
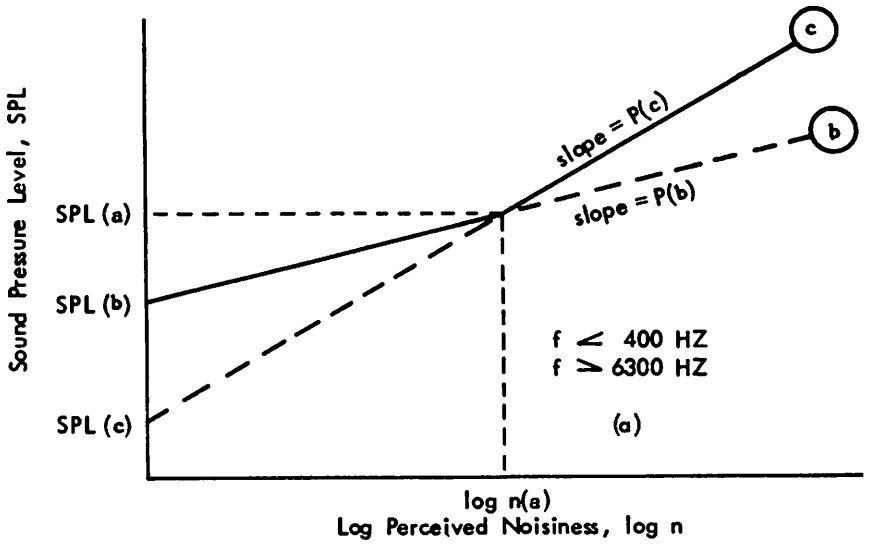

Figure B3. Sound Pressure Level as a Function of Noys.

(c) $0 \leq \log n \leq \log n(a)$.

$$\text{SPL} = p(b) \log n + \text{SPL}(b)$$

(d) $\log n \geq \log n(a)$.

$$\text{SPL} = p(c) \log n + \text{SPL}(c)$$

Case 2. Figure B3(b), $400 \leq f \leq 6300$ Hz.

(a) $\text{SPL} \geq \text{SPL}(c)$.

$$n = \text{ant} \frac{\text{SPL} - \text{SPL}(c)}{p(c)}$$

$$(b) \log n \geq 0.$$

$$SPL = p(c) \log n + SPL(c)$$

Let the reciprocals of the slopes be defined as,

$$M(b) = 1/p(b)$$

$$M(c) = 1/p(c)$$

Then the equations can be written,

Case 1. Figure B3(a), $f < 400$ Hz.

$f > 6300$ Hz.

$$SPL(a) = \frac{M(b)SPL(b) - M(c)SPL(c)}{M(b) - M(c)}$$

$$\log n(a) = \frac{M(b)M(c)[SPL(c) - SPL(b)]}{M(c) - M(b)}$$

$$(a) SPL(b) \leq SPL \leq SPL(a).$$

$$n = \text{ant } M(b)[SPL - SPL(b)]$$

$$(b) SPL \geq SPL(a).$$

$$n = \text{ant } M(c)[SPL - SPL(c)]$$

$$(c) 0 \leq \log n \leq \log n(a).$$

$$SPL = \frac{\log n}{M(b)} + SPL(b)$$

$$(d) \log n \geq \log n(a).$$

$$SPL = \frac{\log n}{M(c)} + SPL(c)$$

Case 2. Figure B3(b), $400 \leq f \leq 6300$ Hz.

$$(a) SPL \geq SPL(c).$$

$$n = \text{ant } M(c)[SPL - SPL(c)]$$

$$(b) \log n \geq 0.$$

$$SPL = \frac{\log n}{M(c)} + SPL(c)$$

Table B4 lists the values of the important constants necessary to calculate sound pressure level as a function of perceived noisiness.

[Section B36.7 of Appendix B amended to redesignate it as Section B36.13; and designate undesignated paragraphs as paragraphs (a), (b), and (c) at 43 FR 8731, March 2, 1978, effective April 3, 1978]

| Band (i) | f HZ | M(b) | SPL (b) dB | SPL (a) dB | M(c) | SPL (c) dB |
|----------|---------|----------|---------------|---------------|----------|---------------|
| 1 | 50 | 0.043478 | 64 | 91.0 | 0.030103 | 52 |
| 2 | 63 | 0.040570 | 60 | 85.9 | " | 51 |
| 3 | 80 | 0.036831 | 56 | 87.3 | " | 49 |
| 4 | 100 | " | 53 | 79.9 | " | 47 |
| 5 | 125 | 0.035336 | 51 | 79.8 | " | 46 |
| 6 | 160 | 0.033333 | 48 | 76.0 | " | 45 |
| 7 | 200 | " | 46 | 74.0 | " | 43 |
| 8 | 250 | 0.032051 | 44 | 74.9 | " | 42 |
| 9 | 315 | 0.030675 | 42 | 94.6 | " | 41 |
| 10 | 400 | - | - | - | " | 40 |
| 11 | 500 | - | - | - | " | " |
| 12 | 630 | - | - | - | " | " |
| 13 | 800 | - | - | - | " | " |
| 14 | 1000 | - | - | - | " | " |
| 15 | 1250 | - | - | - | " | 38 |
| 16 | 1600 | - | - | - | 0.029960 | 34 |
| 17 | 2000 | - | - | - | " | 32 |
| 18 | 2500 | - | - | - | " | 30 |
| 19 | 3150 | - | - | - | " | 29 |
| 20 | 4000 | - | - | - | " | " |
| 21 | 5000 | - | - | - | " | 30 |
| 22 | 6300 | - | - | - | " | 31 |
| 23 | 8000 | 0.042285 | 37 | 44.3 | " | 34 |
| 24 | 10000 | " | 41 | 50.7 | " | 37 |

Table B4. Constants for Mathematically Formulated NOY Values

4.10 NC CURVES

Another rating procedure, which uses “noise-criterion curves,” was developed by Beranek (1957) for design goals for satisfactory background noise inside office buildings and in rooms and halls of various types. It is helpful in deciding where in the spectrum additional effort is required in noise reduction, in order to make the noise acceptable.

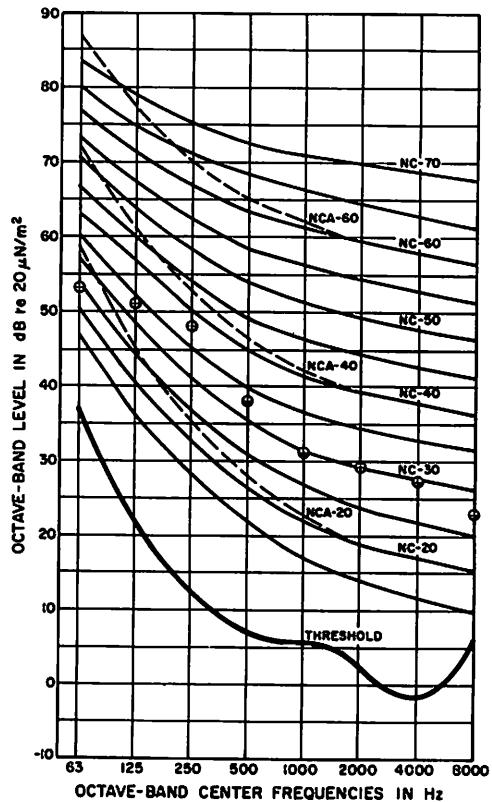

Figure 4-6. Noise-criteria curves.

A set of these NC Curves (Schultz, 1968; ASHRAE, 1972) are shown in Figure 4-6. A threshold curve for octave bands of noise (Robinson and Whittle, 1964), is also shown for reference.

In use, the measured spectrum is plotted on the chart. Each band level is then compared with the NC curves to find the one that penetrates to the highest NC level. The corresponding value on the NC curve is the NC rating of the noise.

As an example, the measured background noise level of an office is shown on the figure as encircled crosses. This noise would have a rating of NC-38. Since a recommended range of NC-30 to NC-40 has been suggested for an executive office (ASHRAE, 1976, p. 356), it would be considered acceptable for that purpose. But if one were to turn it into a conference room, as is sometimes done with large offices, it would not be as acceptable. Here, the recommended range is NC-25 to NC-35. If one were to try to reduce the noise level to make it more acceptable, it is clear from the chart that one should try to find the source of noise in the prominent 250-Hz band and work to reduce that level.

The dashed NCA curves on the figure indicate the direction in which a compromise should be made if economic considerations preclude achieving the normal criterion given by the NC curve.

4.11 NR CURVES

A set of rating values similar to the NC values has been standardized internationally in ISO R1996, "Acoustics, Assessment of Noise with Respect to Community Response" (1971). These are termed NR or noise rating values. They differ from the NC curves in that the rating number corresponds to the 1000-Hz-band sound-pressure level. The related values in other bands also differ somewhat from the NC values, but the general trend is the same.

The NR numbers for octaves have been set to be easily entered in a computer. The values can be calculated from the following formula

$$NR_{OCT} = \frac{L_{OCT} - a}{b}$$

where NR_{OCT} is the noise rating for an octave

L_{OCT} is the measured level in the octave

a and b are constants that vary with the octave as shown in the table

| OCT center f | a | b |
|-----------------|------|-------|
| 31.5 | 55.4 | .681 |
| 63 | 35.5 | .79 |
| 125 | 22 | .87 |
| 250 | 12 | .93 |
| 500 | 4.8 | .974 |
| 1000 | 0 | 1 |
| 2000 | -3.5 | 1.015 |
| 4000 | -6.1 | 1.025 |
| 8000 | -8 | 1.03 |

The calculated value of NR should be rounded to the nearest decibel.

4.12 L_{eq} — EQUIVALENT SOUND LEVEL (EQL)

The sound level at a particular instant is not likely to be a good measure of a noise whose level varies with time over a wide range. A number of descriptors have been developed to take this variation into account. One of these is called the equivalent sound level with the symbol " L_{eq} ."

The equivalent sound level is the weighted sound-pressure-squared values averaged over an interval of time, and this average is then converted to a level in decibels. (Although equivalent sound level is based on an average, the U.S. Environmental Protection Agency is discouraging the use of the term "average" in this connection.) This averaging process is sometimes called an energy average over time, or it is said to be based on the "equal energy principle" (ISO/R1996-1971)

The average used here is not simply an average of sound levels in decibels. But if the sound level varies only a few decibels during the averaging interval, the equivalent sound level is essentially the same as the average of the sound levels.

The equivalent sound level can be calculated from a series of sampled levels of the noise to be rated (see paragraph 14.2). If the sound level changes markedly over the interval, many samples need to be taken in order to obtain a good estimate of the equivalent sound level. The operation can also be completely instrumented to yield the level for a given time interval (see paragraph 14.1).

The number of hours during which the average is taken can be included parenthetically as part of the subscript, thus:

$L_{eq(8)}$ for an 8-hour average

$L_{eq(24)}$ for a 24-hour average

If the average is for a one-hour period, L_n is sometimes used.

If no weighting is specified, "A" weighting is understood for all these levels. If another weighting, for example, "C" is used, it can be included as part of the symbol, thus " L_{Ceq} ."

4.13 L_{dn} — DAY-NIGHT SOUND LEVEL (DNL)

The day-night sound level is a modification of the equivalent sound level. The difference is that during the night (10 p.m. to 7 a.m.) the measured level is increased 10 dB before it is averaged in. This procedure helps to take into account the usual increased interfering effects of noise during the night, particularly when people are trying to sleep (von Gierke and Yanif, 1974; EPA, 1975).

Some further variations of this type have been used. For example, a 5-dB increase is used during the evening hours, and the 10-dB increase is used only at night. This procedure is the one used for CNEL, community noise equivalent sound level, with evening being between 1900 and 2200 hours (7 to 10 p.m.) and night between 2200 and 0700 hours (10 p.m. to 7 a.m.). Although this refinement is a rational one, in actual practice the effect on the result is small; and day-night average sound level and CNEL are generally essentially equal.

The simpler day-night average sound level with only the 10 dB shift at night is the one that is more widely used.

4.14 EXCEEDANCE LEVELS, L_1 , L_{10} , L_{50} , L_{90} , L_{99} , AND SAMPLE DEVIATION

Since noise levels in a community vary significantly during the course of a day, it is logical to make many measurements of the sound level at various times. A sufficient number of measurements should be made to get a representative set. Thousands of measurements are often required to get good accuracy, and the number depends on the variability (Yerges et. al., 1973). Such a set can be acquired either manually or by automated measuring instruments.

Once such a set is acquired, various ways can be used to characterize the data. They can be arranged in ascending order, and then so-called "exceedance levels" can be selected. A subscript is used to designate the percent of the time the level is exceeded. Thus, the median value, L_{50} , is the A-weighted sound level, in dB, that is exceeded 50% of the time,* L_{10} is the level exceeded only 10% of the time and L_{90} is the level exceeded 90% of the time. L_1 and L_{99} are also used, but L_{10} , L_{50} , and L_{90} are the levels most commonly selected. The L_{10} is sometimes regarded as a measure of the more serious intruding noise levels and L_{90} is sometimes considered as the "ambient" or residual noise level (Eldred, 1971). Another way of characterizing the data is by the use of equivalent sound level and the basic statistical measure of the spread of data which is the sample deviation, s or σ (Sigma). It is calculated by use of the deviations of the individual values from the mean value. The deviations for all the values are squared and summed. This sum is then divided by one less than the number of deviations used. The result is called the "variance," s^2 or σ^2 . The square root of the variance is the sample standard deviation.

*It is desirable to note that the equivalent level (EQL or L_{eq}), which was described earlier, is not the same as L_{50} . When the spread of levels is small, however, the equivalent level and L_{50} are nearly the same. L_{eq} is never less than L_{50} .

The USA Department of Housing and Urban Development uses the exceedance levels to determine if a site has an unacceptable noise exposure for a dwelling.* The general external noise exposure standards state that a site is:

1. Unacceptable if the level exceeds 80 dB(A) for 1 hour out of 24 or exceeds 75 dB(A) for 8 hours out of 24.
2. Discretionary — normally unacceptable, if the level exceeds 65 dB(A) for 8 hours out of 24 or if there are loud repetitive sounds on site.
3. Discretionary — normally acceptable, if the level does not exceed 65 dB(A) more than 8 hours out of 24.
4. Acceptable, if the level does not exceed 45 dB(A) more than 0.5 hour out of 24.

It would be possible to observe how long a 65 dB(A) level is exceeded during a 24-hour run and then see if it meets the requirements of less than 8 hours. Or, alternatively, one can take L_{33} (33 1/3% exceedance level) and see if it is below 65 dB(A). Similarly, the half hour out of 24 is a 2.08% exceedance level criterion; the 1 hour out of 24 is 4.17%. This alternate approach that uses the exceedance levels directly has the important advantage that it shows more clearly how much noise reduction is required.

The HUD interior noise exposure limits for acceptable sleeping quarters are:

1. Not to exceed 55 dB(A) for more than 1 hour out of any 24-hour period,
2. Not to exceed 45 dB(A) for more than 0.5 hour during the period from 11 p.m. to 7 a.m., and
3. Not to exceed 45 dB(A) for more than 8 hours in any 24-hour period.

The 0.5 hour out of 8 hours corresponds to a 6.25% exceedance level.

(It is expected in the near future that HUD levels will be changed to L_{dn} values)

4.14.1 TA Another measure of noise exposure that is related to the exceedance levels is called TA (Winer, 1979). TA is the time in minutes that the sound exceeds a specified A-weighted sound level at a given place, usually during a 24-hour period. Thus a TA85 of 30 minutes indicates that the noise exceeded an A-weighted sound level of 85 dB for a total time of 30 minutes during the day. This method of rating is closely related to that used by the U.S. Department of Housing and Urban Development, and it has been applied to rating exposure around airports.

4.15 NEF, CNR AND NOISE AND NUMBER INDEX.

Estimates of the average noise exposure near an airport are usually available from the airport authority. These are more likely to be expressed as a Noise Exposure Forecast (NEF) or as a Composite Noise Rating (CNR) rather than L_{dn} . They are both based on perceived noise level (PNL) measurements and depend on the number of aircraft noise events, with those occurring during the night being more heavily weighted than those occurring during the day.

For comparison purposes, these can be approximately related to the day-night average sound level by the relations (U.S. EPA, 1974):

$$L_{dn} = NEF + 35$$

$$L_{dn} = CNR - 35$$

*U.S. Dept. of Housing and Urban Development, "Noise Abatement and Control: Departmental Policy, Implementation, Responsibilities, and Standards," Circular 1390.2, 8/4/71; 1390.2 CHG 1,9/1/71, Washington, D.C.

(In addition to the approximations involved in these relations, NEF and CNR have been calculated in the past by more than one formula. For NEF, the difference between the formulas used has been as much as 24 dB. It is essential, then, that the conversions be based on recent data.)

Another rating for aircraft noise, called NNI, noise and number index, is based on perceived noise levels. It was developed in Great Britain (Committee on the Problem of Noise, 1963) and takes into account the effect of the number of aircraft per day on the annoyance. It is defined by the following relation:

$$\text{NNI} = (\text{Average Peak Perceived Noise Level}) + 15(\log_{10} N) - 80$$

where N is the number of aircraft per day or night. The value 80 is subtracted to bring the index to about 0 for conditions of no annoyance.

The "Average Peak Perceived Noise Level" is obtained in the following way. The maximum perceived noise level that occurs during the passage of each airplane is noted. These maximum levels are then converted into equivalent power and averaged (Section 2.6). This average value is then converted back into a level and used in the equation.

If the perceived noise level is approximated by the use of A-weighted sound levels, the average A-level is obtained in a similar fashion, the 80 is reduced to about 67, and we have

$$\text{NNI} \approx (\text{Average Peak A-Level}) + 15(\log_{10} N) - 67.$$

4.16 NOISE-POLLUTION LEVEL AND OTHER RATINGS.

Robinson (1969 and 1971) reviews a number of the measures derived in various countries for rating a composite noise history. He lists the following measures: Noise and number index, Composite noise rating, *Storindex*, Indice de Classification, Aircraft Noise Exposure index, Noisiness index, Aircraft Exposure level, Annoyance index, Traffic Noise index, Equivalent Disturbance level, Office Noise Acceptability Scale, and Noise Imission level. Most of these are closely related.

He introduces another measure called "Noise Pollution Level," which is expressed by the relation

$$L_{np} = L_{eq} + 2.56\sigma$$

where L_{eq} is the noise level over a specified period averaged on an energy basis (see Section 4.11), and σ is the standard deviation (rms, see paragraph 4.14) of the instantaneous level about that average value over the same period. (The coefficient of σ is not as accurate as the precision shown, but it was selected by Robinson from a range of possible values to yield a simple relation for certain noise-level distributions.)

The noise level used in the expression can be the A-weighted level, the loudness level, or some other similar level.

In the calculation of noise-pollution level, the time period is to be one in which similar conditions prevail. Thus, for example, night and day would be treated separately.

Some recent studies (Cermak, 1978, 1979) indicate that the addition of a component related to level fluctuations (" σ " in L_{np}) does not improve the correlation of a rating with subjective reactions. The averaged level, L_{eq} , is, however, a highly significant component in rating noise.

The variety of these measures of a noise history reflects the considerable activity in this area and the fact that many factors enter into the effects that are to be

predicted. Different measures are now standardized and used by different groups. Since it is unlikely that a close correspondence will be found between the effects and a combination of physical measurements (Hazard, 1971; Fidell, 1979), some general agreement on a relatively simple relation is urgently needed.

4.17 SOUND EXPOSURE LEVEL — SEL (L_{SE})

Another measure of sound that is related to equivalent sound level but includes duration is sound exposure level (SEL). It is the squared weighted sound pressure integrated or summed over time referenced to the standard pressure squared times one second and then converted to a level. Thus, if a sound having a level of 90 dB persists for 1 second the sound exposure level produced by that sound is 90 dB. If that sound persists for 10 seconds, the sound exposure level is 100 dB. If it persists for 100 seconds, the SEL is 110 dB, and so on.

This level is a logical physical measure of sound that may be most useful in rating transient sounds or discrete events, such as a truck or airplane passby or a punch press impact.

4.17.1 DOSIMETER—NOISE DOSE

Another measure that is an integration of a function of sound pressure over time is used in studying sound exposure in relation to possible damaging effects to the hearing mechanism. This measure is discussed in the previous chapter (see paragraphs 3.4).

4.18 MASKING — “I CAN’T HEAR YOU WHEN THE WATER’S RUNNING.”

It is common experience to have one sound completely drowned out when another louder noise occurs. For example, during the early evening when a fluorescent light is on, the ballast noise may not be heard, because of the usual background noise level in the evening. But late at night when there is much less activity and correspondingly less noise, the ballast noise may become relatively very loud and annoying. Actually, the noise level produced by the ballast may be the same in the two instances. But psychologically the noise is louder, at night, because there is less of the masking noise that reduced its apparent loudness.

Experimenters have found that the masking effect of a sound is greatest upon those sounds close to it in frequency (Egan and Hake, 1950; Fletcher, 1953). At low levels the masking effect covers a relatively narrow region of frequencies. At higher levels, above 60 dB, say, the masking effect spreads out to cover a wide range, mainly for frequencies above the frequencies of the dominating components. In other words, the masking effect is asymmetrical with respect to frequency. Noises that include a wide range of frequencies will correspondingly be effective in masking over a wide frequency range.

4.18.1 Speech-Interference Level. Most of us have been in locations where it was impossible to hear over a telephone because the noise level was too high; and, in order to hear, production machinery had to be turned off, resulting in time and money lost. Even direct discussions can be difficult and tiring because of excessive noise. Excessive noise may make it impossible to give danger warnings by shouting or to give directions to workers. Serious problems may occur because of speech interference from noisy machinery while training employees to operate the machinery.

In a large classroom with heavy acoustical treatment, particularly in the ceiling,

the attenuation may be so great that the teacher at one end can be but poorly heard through the background noise at the other end, even though the noise is not very great.

Incidentally, other factors also affect speech intelligibility. In a live room, speech syllables are smeared by reflected sound, and the intelligibility is consequently reduced.

Because of the annoyance of interference with speech and also because noise interferes with work where speech communication is necessary, a noise rating based on the speech-interference level is frequently useful. We should know how to improve speech communication in a noisy place. In order to effect this improvement we shall find it useful to evaluate the speech-interference level of a noise. How this can be done will appear from a consideration of how noise interferes with speech.

Noise interference with speech is usually a masking process. The background noise increases our threshold of hearing, and, as a result, we may hear only a few or perhaps none of the sounds necessary for satisfactory intelligibility.

The consonants contain most of the information in speech, but, unfortunately, they are more readily masked than vowels, because they are weaker than vowels. Noise of a certain level may mask some speech sounds and not others, depending on the talking level, the particular sound, and the relative frequency distribution of the sound and of the noise.

The energy of the various speech sounds is distributed over the frequency range from below 100 to above 10,000 Hz. The actual instantaneous distribution depends on the particular speech sound. For example, the "s" sound has its energy broadly distributed in the range from 4000 to beyond 8000 Hz. In contrast, most of the energy in the "ee" sound of "speech" is distributed in fairly definite groups (called "formants") below 4000 Hz. All the frequency range of speech sounds is not necessary, however, for complete intelligibility. A number of experimenters have shown that nearly all the information in speech is contained in the frequency region from 200 to 6000 Hz.

In any frequency subdivision that we may make of this range, the sound-pressure levels vary over a range of about 30 dB, as successive sounds occur. Tests on the intelligibility of speech show that, if we can hear the full 30-dB range in each of the frequency bands into which speech is divided, the contribution to intelligibility by that band will be 100 percent. If, however, noise limits the range that can be heard to only 15 dB, the contribution will be about 50%, and so forth. Furthermore, if the range between 200 to 6000 Hz is divided into a large number of frequency bands of equal importance to speech intelligibility, the total contribution to speech intelligibility is equal to the average of the contributions from the individual bands. This quantity is called the articulation index, because it is a measure of the percentage of the total possible information that we might have perceived of importance to speech intelligibility (French et al., 1947; Beranek, 1947; Kryter, 1962; ANSI S3.5-1969).

For many noises, the measurement and calculation can be simplified even further by the use of a three-band analysis (Beranek, 1947). The bands chosen are the octave bands centered on 500, 1000, and 2000 Hz.* The arithmetic average of the sound-pressure levels in these three bands gives the quantity called the three-

*The bands used before the shift to the currently preferred series were 600-1200, 1200-2400, and 2400-4800 Hz, or those three bands plus the band from 300 to 600 Hz. The results of the two measures are similar, but some shift in the reference values is necessary (Webster, 1965, 1969; Waltzmann and Levitt, 1978).

band preferred octave speech-interference level (PSIL). One can use this level for determining when speech community or telephone use is easy, difficult, or impossible, and one can determine what changes in level are necessary to shift from one order of difficulty to a lower order.

A recent standard (ANSI S3.14-1977) uses the arithmetic average of the levels in the four octave bands centered on the frequencies 500, 1000, 2000, and 4000 Hz. The results with those bands are described in that standard. When speech interference from noise is most serious, the PSIL measure may be more useful (Webster and Cliff, 1974), and it is used here.

Face-To-Face Communication. For satisfactory intelligibility of difficult speech material, maximum permissible values of speech-interference levels for men with average voice strengths are given in Figure 4-7, which is an extension by Webster of Beranek's work (Webster, 1969).

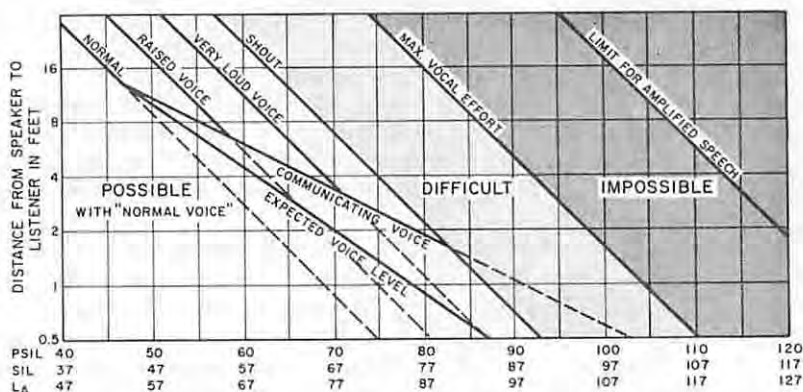

Figure 4-7. Rating chart for determining speech communication capability from speech interference levels. (By permission, Webster, 1969.)

It is assumed in this chart that there are no reflecting surfaces nearby, that the speaker is facing the listener, and that the spoken material is not already familiar to the listener. For example, the speech-interference level of the factory noise in paragraph 4.5.4 is 80 dB, which is high, and the chart indicates that the two people must ordinarily be no more than two feet apart in order to be understood satisfactorily. If the words spoken are carefully selected and limited in number, intelligible speech will be possible at greater distances.

If a number of conversations are to be held in the same reverberant room, the procedure is more complicated. This chart cannot be used on the basis of the background-noise level before the conversations are in progress, because a given conversation will be subject to interference from the noise produced by all the other conversations. The general procedure for calculating a speech-interference level under those conditions has not been completely worked out.

Telephone Usability in Noisy Areas. The speech-interference level can also be used to predict the expected usability of a telephone under given noise conditions. The following schedule has been found generally satisfactory, when the F-1 Western Electric handset is used for long-distance or suburban calls.

| Speech-Interference Level | Telephone Use |
|---------------------------|---------------|
| less than 60 dB | Satisfactory |
| 60 to 75 dB | Difficult |
| above 80 dB | Impossible |

For calls within a single exchange, the permissible speech-interference levels are 5 dB greater than those shown.

Criteria for Indoor Noise Levels. A suggested rating system for offices, based on a number of psychological and acoustical tests, is shown in Figure 4-8. The curves on this graph relate the measured speech-interference level of the background noise and the subjective rating of the noise ranging from "very quiet" to "intolerably noisy." The two different rating curves illustrate that the environment influences the subjective rating. In order to be rated "noisy" the noise level must be appreciably higher in a large office than in a private office.

It can be expected that the probability of receiving complaints about noise will be high for subjective ratings above "moderately noisy" and low for subjective ratings below "moderately noisy." Furthermore, because of direct interference with transferring information, efficiency may be reduced for levels appreciably above the criterion points marked A and B.

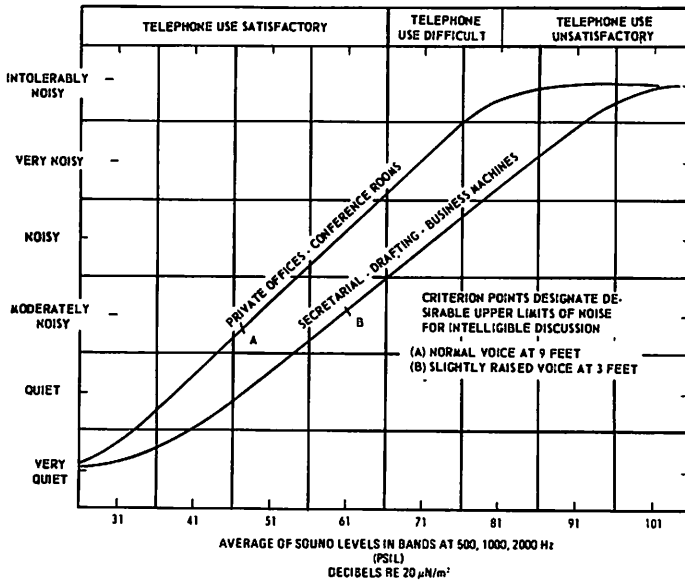

Figure 4-8. Rating chart for office noises. Data were determined by an octave-band analysis and correlated with subjective tests. (Courtesy Beranek and Newman, but modified for preferred bands).

Suggested criteria for noise control in terms of maximum permissible speech-interference level (PSIL), measured when the room is not in use, are given in Table 4-5.

The purpose of these criteria will be shown by the following example. Assume that we are to put a small conference room in a factory space. We measure the speech-interference level at that location and find it to be 69 dB, whereas the suggested speech-interference level criterion for a small conference room is 35 dB. The room must then be designed to attenuate the noise from the factory space by about 34 dB, in order to have a conference room that will be satisfactory as far as background noise level is concerned (such an attenuation is provided by a double-plastered, three- or four-inch thick stud wall, or by a hollow-tile wall plastered on one side).

Table 4-5
CRITERIA FOR NOISE CONTROL

| Type of Room | Maximum Permissible PSIL (measured when room is not in use) |
|---|---|
| Small Private Office | 45 |
| Conference Room for 20 | 35 |
| Conference Room for 50 | 30 |
| Movie Theatre | 35 |
| Theatres for Drama (500 seats, no amplification) | 30 |
| Coliseum for Sports Only (Amplification) | 55 |
| Concert Halls (No amplification) | 25 |
| Secretarial Offices (Typing) | 60 |
| Homes (Sleeping Areas) | 30 |
| Assembly Halls (No amplification) | 30 |
| School Rooms | 30 |

A similar but more extensive set of such criteria for noise control, based on A-weighted sound levels, is given in the *Handbook and Product Directory 1976 Systems*, page 35.6, of the American Society of Heating, Refrigerating and Air-Conditioning Engineers.

Privacy. Privacy of conversation is often desired both in the home or apartment and in business. The use of extensive and carefully constructed sound isolation is the safest way to ensure privacy. This approach is expensive, however.

If the noise level outside an executive office is relatively high, only a moderate amount of isolation may be needed to bring the speech level from the office to the point outside the office where it is masked by the background noise. It is important then that the executive office have a background PSIL below 45 dB, in order to avoid encouraging a raised voice level. An exceptionally low background noise level, however, may make it possible for the one in the office to hear those outside, and he will then feel that his office is not private even though it may be so in fact. The inverse may also be true.

If his air conditioner is exceptionally noisy, he may feel that his speech will be covered by the noise. But if the adjacent space is relatively quiet, he may be overheard. In fact, privacy in offices depends on some background noise as well as isolation and distance (Cavanaugh, et al., 1962; Young, 1965), and mutual privacy is often essential. This approach to privacy sometimes requires that noise be introduced, often conveniently by way of turbulent noise from a ventilator grill (Waller, 1969).

4.19 CRITICAL RATIO AND CRITICAL BANDWIDTH.

Early studies of masking led Fletcher (1953) to define a critical bandwidth of hearing. He measured the threshold of pure tones masked by wide bands of noise whose frequency range spread about that of the tone. In the comparison of the levels of the tone and the noise, he used the spectrum level of the noise, which is the level that would be obtained if the noise were filtered through an ideal filter 1-Hz wide (see Chapter 8). He found that, for a wide range of levels, the difference between the threshold level of the masked tone and the spectrum level of the noise was a constant. This constant is now often called a critical ratio. It varies with the frequency of the pure tone, from about 17 dB at 300 Hz to about 28 dB at 8000 Hz (Hawkins et al., 1950). At frequencies below about 500 Hz, the ratio does not change much with frequency.

Fletcher tried narrowing the bandwidth of the noise but with its frequency range centered on the frequency of the tone. He found that above a certain

critical bandwidth the critical ratio was reasonably independent of the bandwidth. Below this critical bandwidth the critical ratio decreased, that is, the tone could be more readily heard in the noise. This experiment led to the concept that masking by a noise is mainly a result of the noise energy within a certain frequency band.

The values quoted for this critical bandwidth are small, being about 50-Hz wide at 250 Hz and 500 Hz, increasing to about 600 Hz at 8000 Hz. Since then, the results of many experiments have shown large enough variations to cast doubt on the reliability of the critical-band measurement by this technique (de Boer, 1962; Green and Swets, 1966).

Other psychoacoustical measurements have led to specifications of critical bands that are appreciably wider than those quoted above. For example, the loudness of a band of noise is observed as a function of the bandwidth of the noise with constant overall level. The experiments show that up to a certain critical bandwidth the loudness is essentially independent of the bandwidth. Beyond that point the loudness increases with constant over-all sound-pressure level (Zwicker et al., 1957). This critical bandwidth is relatively independent of the level.

This loudness critical band is found to be about 90 Hz wide, centered at 100 Hz, 110 Hz at 500 Hz, and thereafter increasing to about 2300 Hz at 10,000 Hz. Over much of the range it can be reasonably well approximated by a one-third octave. The Zwicker method of loudness calculation is based in part on use of these critical bands (Zwicker, 1960).

4.20 ADDITIONAL HEARING CHARACTERISTICS.

In addition to the characteristics already described, numerous others have been investigated, and a few of these are of interest in noise-measurement problems. Therefore, we shall discuss briefly differential sensitivity for intensity and the pitch scale.

4.20.1 Differential Sensitivity for Intensity. One question that comes up in quieting a noisy place or device is: "Just how little a change in level is worth bothering with? Is a one-decibel change significant, or does it need to be twenty decibels?" This question is partially answered in the section on loudness, but there is additional help in the following psychoacoustical evidence. Psychologists have devised various experiments to determine what change in level will usually be noticed (Stevens, 1951). When two different levels are presented to the observer under laboratory conditions with little delay between them, the observer can notice as small a difference as $\frac{1}{4}$ dB for a 1000-Hz tone at high levels. This sensitivity to change varies with level and the frequency, but over the range of most interest this differential sensitivity is about $\frac{1}{4}$ to 1 dB. For a wide-band random noise (a "hissing" sound) a similar test gives a value of about $\frac{1}{2}$ dB for sound-pressure levels of 30 to 100 dB (re 20 μ Pa). Under everyday conditions, a 1-dB change in level is likely to be the minimum detectable by an average observer. On the basis of these tests, we can conclude that 1-dB total change in level is hardly worth much, although 6 is usually significant. It should be remembered, however, that many noise problems are solved by a number of small reductions in level. There is also the importance of a change in character of the noise. For example, the high-frequency level of a noise may be reduced markedly by acoustic treatment, but, because of strong low-frequency components, the over-all level may not change appreciably. Nevertheless, the resultant effect may be very much worthwhile. This example illustrates one reason for making a frequency analysis of a noise before drawing conclusions about the noise.

4.20.2 Pitch and Mels. Just as they have done for loudness, psychologists have experimentally determined a scale for pitch (Stevens et al., 1937). The unit for this scale is the "mel" (from "melody"), and a 1000-Hz tone at a level of 40 dB is said to have a pitch of 1000 mels. In terms of frequency, this pitch scale is found to be approximately linear below 1000-Hz and approximately logarithmic above 1000-Hz. Some people have suggested that a frequency analysis with bands of equal width in mels would be more efficient for some types of noise analysis than would one with bands of other widths. At present no commercial analyzers of this type are available, but some work has been done using such an analysis. In addition, the pitch scale has been found useful for some types of charts.

4.21 WEIGHTED SOUND LEVELS.

Rating noise by loudness level, perceived-noise level, perceived level, speech-interference level, or a noise-criterion curve is sufficiently complex that simpler techniques have been sought. Often the simpler approach is to return to the earlier procedures, that is, to use one or two of the presently available weightings on the sound-level meter when rating noises of similar character. The A-weighting sound level has been the most successful of these measures (Young, 1958, 1964; Parkin, 1965; Botsford, 1969).

Another suggested approach is to use a new weighting characteristic, and some of these will be described briefly before reviewing the relative success of weighting networks and their limitations.

4.21.1 Other Weighting Characteristics. Among a number of weighting characteristics that have been suggested recently, N, D or D_1 , and D_2 have been proposed for estimating perceived-noise level (Kryter, 1970, Kryter and Pearsons, 1963) E (for Ear) has been suggested for perceived level (Stevens, 1972) and SI is proposed for speech interference (Webster, 1969). These weighting characteristics are shown plotted in Figure 4-9 along with the standard A-weighting. The N weighting is not shown, since it is the same as the D weighting but raised in level by 7 dB (Batchelder, 1968).

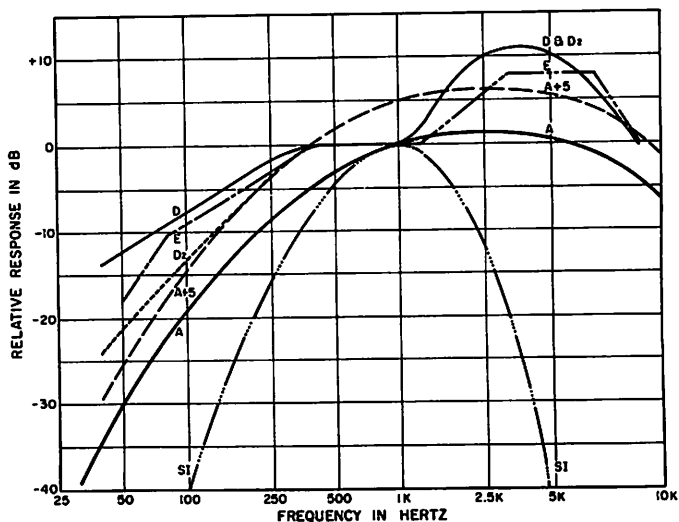

Figure 4-9. A-weighting and other proposed weightings.

HDNM 9

The A-weighting raised by 5-dB is also shown for comparison. It is easy to see that the trends of the D, D₂, and E weightings are similar to that of A. As a result, if we are concerned mainly with rank ordering noises whose energy is widely distributed over the frequency range, we would not expect marked differences in usefulness among these weightings.

4.21.2 Comparison of Calculation Schemes and Weighted Levels. We shall discuss briefly a number of techniques for the following tasks:

1. Predict a subjective effect of any of a variety of noises including a reference tone or narrow band of noise.
2. Rank order any of a variety of common noises for a particular subjective effect.
3. Rank order noises of similar character, for example, automobiles, for their subjective effects.
4. Predict from a weighted level the answer that a calculation scheme gives on a variety of noises.

We must recognize, as discussed earlier, that subjective effects are not consistent to start with, and many factors beyond the physical measurements can enter into the result. Even as far as physical measurements are concerned, however, the effect of the duration of the noise, for example, is an important factor that cannot yet be adequately taken into account.

If we ignore these points and concentrate on the relative behavior of the various weighting and calculation schemes, we find that the calculation schemes tend to be more consistent than a simple weighting for predicting results if they are to be referenced to a tone or a narrow band of noise (Fletcher and Munson, 1933; Churcher and King, 1937; Beranek et al., 1951; Quietzsch, 1955; Stevens, 1956; Kryter, and Pearsons 1963; Bauer et al., 1971; but see Corliss and Winzer, 1965, for an exception). Some relatively large discrepancies in loudness, for example, appear in comparing wide-band noise and a pure tone if a weighted level is used but the loudness predicted from a calculation scheme can be much more nearly in agreement with the subjective effect.

Such errors made in predictions from weighted levels led to many of the studies of loudness summation and to various calculation schemes.

The situation is somewhat different if we merely need to rank order a variety of common noises for their loudness or perceived noise level. Then, if A-weighting or a similar one is used, the consistency is fairly good (Young, 1964; Klumpp et al., 1963). But a C-weighted level almost always appears to be significantly poorer than an A-weighted level in consistency (Wells, 1969). The consistency for interference with speech for a variety of noises (Webster, 1969), for example, is particularly poor for a C-weighted level (standard deviation [σ] = 7.4 dB), better for an A-weighted level (σ = 4.7 dB), and still better for PSIL (σ = 2.8 dB).

Because of the nature of the speech-interference effect, the proposed SI weighting should be better than A-weighting for predicting interference, but it should not be as good for predicting other effects, such as loudness.

When we rank order noises of similar character, for example, automobiles or aircraft, we find still less significance in the difference in behavior between the calculation schemes and an A-weighted or similar level (Hillquist, 1967; Young, 1964; Young and Peterson, 1969; Lavender, 1971). But again the C-weighted level is generally poor.

Because the calculation schemes are used for specific effects, a number of studies have been made of how well the various weighted levels can be used to

predict the results of the calculation schemes. As a general rule the weightings that are closely related to the calculation scheme tend to predict the related result slightly better than other weightings (e.g. Parkin, 1965; Stevens, 1972). Since the A weighting has the same general trend as the weightings used in the calculation schemes, it tends to work reasonably well for any of them (Loye, 1956; Botsford, 1969). It should be recognized that this predictability is only of limited value, since it is removed by one additional variability from the subjective effect.

The relative uniformity of the basic data used for loudness and perceived noise (Stevens, 1972), and the success, however modest, of the A-weighted level in comparison with the C-weighted level leads one to conclude that some improvement could probably be obtained for rating many noises by the use of a weighting that is more like the E or the D₂ weighting (Kryter, 1970; Stevens, 1972).

The speech-interference level appears to be in a different category, however. Because the speech-frequency range is more limited, it is likely that a weighting such as the D₂ or E would be no better, if not less satisfactory, than the A weighting. PSIL is still the approach to use in this application.

4.21.3 A-Weighted Sound Level as a Single-Number Rating. For simple ratings or screenings of similar devices, the A-weighted sound level at a specified distance is now widely used. This measurement is mainly useful for relatively nondirectional sources that are outdoors and where the effect of the noise also occurs outdoors and nearby. It is also useful in preliminary ratings of similar ambient noises for the human reactions that may occur. Measurement of A-weighted sound-level has been adopted for checking compliance with many ordinances and regulations.

Because of its widespread use, a number of investigators have determined the approximate relation between the A-weighted sound-level of a noise and the calculated loudness level, perceived noise level, and speech-interference level of the noise. Table 4-6 shows the results compiled from various sources (Robinson et al., 1963; Parkin, 1965; Young, 1964; Young and Peterson, 1969; Hillquist, 1967; Nakano, 1966; Klumpp and Webster, 1963; ASHRAE, 1972; Jahn, 1965). Because the calculation schemes changed somewhat over the years, complete uniformity in procedures was not maintained; but the effects of the changes were small.

Table 4-6
COMPARATIVE NOISE RATINGS

| Noise Type | LL-L _A (dB) | PNL-L _A (dB) | L _A -PSIL (dB) |
|--------------------|---------------------------|----------------------------|------------------------------|
| Office | 13 | 13 | 6 |
| Truck | 10 | 13 | |
| Pneumatic Machines | 13 | 14 | |
| Ship Compartment | 14 | 15 | |
| Urban | | 16 | |
| Aircraft | 9 | 12 | |
| | | 14 | |
| | | 16 | |
| | | 14 | |
| Aircraft | | | 9 |
| | | | 4 |
| Diverse | | 12 | 10 |
| Airflow | 12 | | |

LL = Loudness level by Stevens Mark VI

PNL = Perceived noise level ~ 1963-65

PSIL = Three-band preferred-octave speech-interference level

L_A = A-weighted sound level

In order to get more consistent results in these relations, Botsford (1969) has used the difference in the C-weighted and A-weighted levels as an additional parameter. He has compiled an extensive set of charts for the various quantities and their relations to the A and C-A level. For the 953 noises he uses, the correlation and standard deviation are relatively good, being poorest for speech-interference level, which had a standard deviation of 2.9 dB (see also Shimizu, 1969).

4.21.4 Some Limitations of a Weighted Sound Level. When only a single weighted sound level is measured, the usefulness of the measurement is severely restricted. One should almost always try to measure the spectrum also. The spectrum is needed for efficient noise control, because the effects of sound isolation, acoustic treatment, vibration reduction and other forms of noise control are frequency dependent. In addition, the reaction to the noise is frequency dependent, and the spectrum can show us the frequency region where the noise energy is most important in determining the effects.

We almost always want to know the reason for the noise rating. The spectrum often provides the most important clues for tracking down and reducing the noise.

If a noisy machine is to be used in a room, we need to know the acoustic characteristics of the room as a function of frequency and the radiated-sound-power level in octave or third-octave bands, in order to estimate the noise level at some distance from the machine.

The spectra help in the long run in providing data for later comparisons when conditions change or if better evaluation techniques are developed.

The limitations of the simple, weighted measurement should be recognized when plans for sound measurements are being made.

4.22 COMMUNITY RESPONSE TO NOISE.

With the growth in air transportation, more and more people near major airports have been bothered by aircraft noise. Many lawsuits have been filed on behalf of those afflicted by the noise in an attempt to recover damages, to stop further expansion, or to limit the use of certain runways. Such action is a strong response to a noise problem, but often it is not unreasonable in view of the provocation.

Air conditioners, hi-fi systems, and power tools for the garden are examples of other noise sources that can cause complaints and squabbles among neighbors.

Because of such noise problems, some reasonable way of predicting the expected community response to noise would be a valuable guide for setting limits on acceptable noise levels. As indicated previously, the response from person to person varies greatly. When a large population is exposed to the same noise, however, some estimates of the average reaction can be made. But measurement of the equivalent sound level, L_{eq} , is not considered by some to be adequate for predicting even this average response. If, though, a number of other factors are included, the resulting predictions are reported to be good enough to be useful. Such additional factors were proposed by Rosenblith et al. (1953) and Stevens et al. (1955) for use with octave-band charts, but they have since been adapted for use with other noise measures, such as the day-night average sound level, L_{dn} .

Factors that have been proposed as important in relating community response and noise exposure include the following (EPA, 1974; Schultz, 1972; Parrack, 1957)

1. Spectrum level and shape. The factors are included in L_{eq} and L_{dn} by use of the A-weighted sound level.

2. Variation with time. The energy averages of L_{eq} and L_{dn} in effect include this, but much more weight is given the variation with time in some noise measures, e.g., L_{NP} .
3. Time of day. L_{dn} includes a factor for this effect.
4. Time of year. In cold weather, residences are usually better isolated from external noises, because doors and windows are shut.
5. Previous exposure. It is contended that people are conditioned by their previous exposure to noise.
6. Pure tones. For a given level, a noise that has audible pure tone components is said to be more objectionable than a noise that does not.
7. Impulsive nature. An impulsive noise needs to be rated differently from one that is not impulsive.
8. Community acceptance. It has been suggested that acceptance of the purpose of the activity that has noise as a by-product leads to more tolerance of the noise.
9. Socio-economic status.

Many of these factors can be regarded as part of the noise exposure, whereas some are related to the particular community.

Those factors that are not already included in L_{dn} can be used to adjust the measured value when prediction of community reaction is necessary. These adjustments are usually made by adding or subtracting 5 dB or more to L_{dn} , depending on the nature and extent of the neighborhood conditions. When L_{dn} has been adjusted in this way, it is sometimes called "normalized" (Eldred, 1974; Goodfriend, 1975).

Schultz (1978) has converted the available data to find a relation between the percentage of those highly annoyed and the day-night equivalent level. His relation is reduced to a formula:

$$\% \text{Highly Annoyed} = .8553L_{dn} - .0401L_{dn}^2 + .00047L_{dn}^3$$

At levels below 55 the formula shows values too low to be significant, which indicates that at such levels only minor problems should arise. At levels above 85 dB, the % Highly Annoyed exceeds 70%, which indicates that there is a very serious problem. Here are some representative values calculated from the formula:

| L_{dn} dB | Highly Annoyed % |
|----------------|---------------------|
| 60 | 8 |
| 65 | 15 |
| 70 | 25 |
| 75 | 37 |
| 80 | 52 |
| 85 | 72 |

4.23 EFFECT OF NOISE ON WORK OUTPUT.

Noise can influence work output in many ways; it can interfere with communication (paragraph 4.18.1), and it can cause a decrease in the quality of work output when the background noise level is above 90 dB, but noise is occasionally useful as a means of masking distracting conversations.

Broadbent (1958, 1979) and others (Hockey, 1978) have found that the effects of noise on work output depend greatly upon the nature of the work; a long-term job requiring constant vigilance is especially susceptible. Noise is more likely to cause a higher rate of errors and accidents than an actual reduction in total output. This result and other findings lead to the interpretation that attention wanders from the work at hand more often as the noise level increases.

From the standpoint of noise reduction, two findings are worth noting: first, noise is more likely to lead to increased errors in susceptible tasks if it is above 90 dB; and second, high-frequency audible noise seems more harmful in this respect than does low-frequency noise.

4.24 EFFECT OF NOISE ON SLEEP.

The disruption of sleep by sound is universally experienced. The interfering sound may be a baby's cry or the roar of a passing truck. Since undesired interruptions can be most annoying, numerous investigators have studied the problem. A review of these studies leads Lukas (1975) to conclude that: "To limit the probability of sleep disruption, single-event noise levels should not exceed 70 EPN dB or about 57 dB(A)." Here the "E" refers to "effective" and is the duration adjustment that is commonly used for aircraft noise (see paragraph 4.8). That adjustment recognizes the fact that the duration of a sound as well as the level is important in determining the interfering effect.

Since the correlation between these measures and sleep disruption is not remarkably high, there is little need for use of the sophisticated EPNdB. The measure that would be more reasonable to use here is the A-weighted sound-exposure level (SEL_A) for single events (see paragraph 4.17). The value for $EdB(A)$ is referenced to 10 seconds, whereas SEL is referenced to 1 second, which corresponds to a 10 dB difference. Thus, the SEL_A should be limited to 67 dB. The measurement of SEL should be restricted to the effective duration of the single event.

4.25 NON-AUDITORY EFFECTS OF NOISE ON MAN.

Glorig (1971), Kryter (1970), Burns (1979), and Stephens and Rood (1978) have summarized the present knowledge of nonauditory effects of noise exposure. Very high levels (120 to 150 dB), at certain resonant frequencies of the body structure, can produce noticeable symptomatic reactions. Even moderate noise levels produce temporary changes in the size of some blood vessels, but it is not clear that these effects eventually produce permanent changes. The production of stress and fatigue by noise exposure is difficult to verify in a meaningful way.

REFERENCES

Standards

- ANSI S3.4-1968, Computation of the Loudness of Noise
- ANSI S3.5-1969, Calculation of the Articulation Index
- ANSI S3.14-1977, Speech Interference
- ISO/R131-1959, Expression of the Physical and Subjective Magnitudes of Sound or Noise
- ISO/R226-1967, Normal Equal-Loudness Contours for Pure Tones
- ISO/R1996-1971, Acoustic Assessment of Noise with Respect to Community Response

Other

- AIHA (1975), *Industrial Noise Manual*, Third Edition, American Industrial Hygiene Association, 66 S. Miller Road, Akron, Ohio 44313.
- ASHRAE (1972), *Handbook of Fundamentals 1972*, American Society of Heating, Refrigerating and Air-Conditioning Engineers, Inc., 345 East 47th St., New York, NY 10017, Chapter 6.
- ASHRAE (1976), *ASHRAE Handbook and Product Directory 1976 Systems*, ASHRAE, New York, Chapter 35.
- L. Batchelder (1968), "Standards Note: D- and N-Weighted Sound Levels," *J Acoust Soc Am*, Vol 44, #4, October 1968, pp 1159f.
- B.B. Bauer, E.L. Torick and R.G. Allen (1971), "The Measurement of Loudness Level," *J Acoust Soc Am*, Vol 50, #2 (Part 1), August 1971, pp 405-414.
- G. von Békésy (1960), *Experiments in Hearing*, (E.G. Wever, trans and ed), McGraw-Hill, New York.
- L.L. Beranek (1947), "The Design of Speech Communication Systems," *Proc IRE*, Vol 35, #9, September 1947, pp 880-890.
- L.L. Beranek (1957), "Revised Criteria for Noise in Buildings," *Noise Control*, Vol 3, #1, pp 19-27.

- L.L. Beranek, J.L. Marshall, A.L. Cudworth and A.P.G. Peterson (1951), "The Calculation and Measurement of the Loudness of Sounds," *J Acoust Soc Am*, Vol 23, #3, May 1951, pp 261-269.
- E. de Boer (1962), "Note on the Critical Bandwidth," *J Acoust Soc Am*, Vol 34, #7, July 1962, pp 985f.
- J.H. Botsford (1969), "Using Sound Levels to Gauge Human Response to Noise," *Sound and Vibration*, Vol 3, #10, October 1969, pp 16-28.
- D.E. Broadbent (1958), *Perception and Communication*, Pergamon Press, New York.
- D.E. Broadbent (1979), "Human Performance and Noise," in Harris (1979).
- W. Burns (1979), "Physiological Effects of Noise," in Harris (1979).
- W. Burns (1973), *Noise and Man*, Second Edition, John Murray, London.
- N.L. Carter and K.T. Kryter (1962), "Masking of Pure Tones and Speech," *J Auditory Res*, Vol 2, #1, January 1962, pp 66-98.
- W.J. Cavanaugh, W.R. Farrell, P.W. Hirtle and B.G. Watters (1962), "Speech Privacy in Buildings," *J Acoust Soc Am*, Vol 34, #4, April 1962, pp 475-492.
- G.W. Cermak (1979), "Exploratory Laboratory Studies of the Relative Aversiveness of Traffic Sounds," *J Acoust Soc Am*, Vol 65, #1, Jan 1979, pp 112-123.
- G.W. Cermak (1978), "Choices among traffic sounds with equal L_{eq} levels: A replication," *J Acoust Soc Am*, Vol 63, #S1, Spring 1978, p570, Abstract BB8.
- J.D. Chalupnik, ed. (1970), *Transportation Noises, A Symposium on Acceptability Criteria*, University of Washington Press, Seattle.
- B.G. Churcher and A.J. King (1937), "The Performance of Noise Meters in Terms of the Primary Standard," *JIEE* (London), Vol 84, pp 57-90.
- Committee on the Problem of Noise (1963), "Noise — Final Report," CMND, 2056, Her Majesty's Stationery Office, London, 1964.
- E.L.R. Corliss and G.E. Winzer (1965), "Study of Methods for Estimating Loudness," *J Acoust Soc Am*, Vol 38, #3, September 1965, pp 424-428.
- H. Davis and S.R. Silverman (1978), *Hearing and Deafness*, Fourth Edition, Holt, Rinehart and Winston, Inc., New York.
- J.P. Egan and A.W. Hake (1950), "On the Masking Pattern of a Simple Auditory Stimulus," *J Acoust Soc Am*, Vol 22, #5, September 1950, pp 622-630.
- K.M. Eldred (1971), *Community Noise*, U.S. Environmental Protection Agency, Report No. NTID300.3 (December 31, 1971), U.S. Government Printing Office, Washington, D.C.
- K.M. Eldred (1974), "Assessment of Community Noise," *Noise Control Engineering*, Vol 3, No 2, Sept-Oct 1974, pp 88-95.
- EPA (1973), *Public Health and Welfare Criteria for Noise*, July 27, 1973, No. 550/9-73-002, U.S. Environmental Protection Agency, Washington, DC 20460.
- EPA (1974), *Information on Levels of Environmental Noise Requisite to Protect Public Health and Welfare with an Adequate Margin of Safety*, No. 550/9-74-004, (This publication is often called the "Levels" document.) U.S. Environmental Protection Agency, Washington, DC 20460.
- EPA (1975), *Model Community Noise Control Ordinance*, September 1975, No. 550/9-76-003, U.S. Environmental Protection Agency, Washington, DC 20460.
- S. Fidell (1979), "Community Response to Noise," Chapter 36 in Harris (1979), p. 36.7.
- J.L. Flanagan (1965), *Speech Analysis Synthesis and Perception*, Academic Press, New York.
- H. Fletcher (1953), *Speech and Hearing in Communication*, D. Van Nostrand, New York.
- H. Fletcher and W.A. Munson (1933), "Loudness, Its Definition, Measurement and Calculation," *J Acoust Soc Am*, Vol 5, #2, October 1933, pp. 82-108.
- H. Fletcher and W.A. Munson (1937), "Relation Between Loudness and Masking," *J Acoust Soc Am*, Vol 9, #1, July 1937, pp 1-10.
- N.R. French and J.C. Steinberg (1947), "Factors Governing the Intelligibility of Speech Sounds," *J Acoust Soc Am*, Vol 19, #1, January 1947, pp 90-119.
- A. Glorig (1958), *Noise and Your Ear*, Grune & Stratton, New York.
- A. Glorig (1971), "Non-Auditory Effects of Noise Exposure," *Sound and Vibration*, Vol 5, #5, May 1971, pp 28f.
- L.S. Goodfriend (1975), "Community Noise Regulations," *Noise Control Engineering*, Vol 4, No 2, March-April 1975, pp 50f.
- D.M. Green and J.A. Swets (1966), *Signal Detection Theory and Psychophysics*, John Wiley & Sons, Inc., New York.
- C.M. Harris, ed. (1957), *Handbook of Noise Control*, McGraw-Hill, New York.
- C.M. Harris, ed. (1979), *Handbook of Noise Control*, McGraw-Hill, New York, Second edition.
- J.E. Hawkins, Jr. and S.S. Stevens (1950), "The Masking of Pure Tones and of Speech by White Noise," *J Acoust Soc Am*, Vol 22, #1, January 1950, pp 6-13.

- W.R. Hazard (1971), "Predictions of Noise Disturbance Near Large Airports," *J Sound and Vib*, Vol 15, #4, 22 April 1971, pp 425-446.
- R.K. Hillquist (1967), "Objective and Subjective Measurement of Truck Noise," *Sound and Vib*, Vol 1, #4, April 1967, pp 8-13.
- I.J. Hirsh (1952), "The Measurement of Hearing," McGraw-Hill, New York.
- G.R.J. Hockey (1978), "Effects of noise on human work efficiency" in D.N. May (1978).
- M. Jahn (1965), "Subjective und Objective Bewertung von Maschinen Gerauschen," *Acustica*, Vol 16, #3, 1965/66, pp 175-186.
- R.G. Klumpp and J.C. Webster (1963), "Physical Measurements of Equal Speech-Interfering Navy Noises," *J Acoust Soc Am*, Vol 35, #9, September 1963, pp 1328-1338.
- C.W. Kosten and G.J. Van Os (1962), "Community Reaction Criteria for External Noises," National Physical Laboratory Symposium No. 12, *The Control of Noise*, Her Majesty's Stationery Office, London, pp 373-387.
- K.D. Kryter (1962), "Methods for the Calculation and Use of the Articulation Index," *J Acoust Soc Am*, Vol 34, #11, November 1962, pp 1689-1697. ("Validation of the Articulation Index," pp 1698-1702.)
- K.D. Kryter (1968), "Concepts of Perceived Noisiness, Their Implementation and Application," *J Acoust Soc Am*, Vol 43, #2, Feb 1968, pp 344-361.
- K.D. Kryter (1970), *The Effects of Noise on Man*, Academic Press, Inc., New York, Chapter 11 and Part III.
- K.D. Kryter and K.S. Pearsons (1963), "Some Effects of Spectral Content and Duration on Perceived Noise Level," *J Acoust Soc Am*, Vol 35, #6, June 1963, pp 866-883.
- D.C. Lavender (1971), "Interpretation of Noise Measurements," *J Sound and Vib*, Vol 15, #1, 8 March 1971, pp 1-9.
- D.M. Lipscomb and A.C. Taylor, Jr., eds. (1978), *Noise Control: Handbook of Principles and Practices*, Van Nostrand Reinhold, New York.
- D.P. Loye (1956), "The Legal Aspects of Noise Control," *Noise Control*, Vol 2, #4, July 1956, pp 56-60.
- J.S. Lukas (1975), "Noise and sleep: A literature review and a proposed criterion for assessing effect," *J Acoust Soc Am*, Vol 58, #6, June, pp 1232-1242.
- A.C. McKennel and E.A. Hunt (1966), "Noise Annoyance in Central London," Report S 332, U.K. Government Social Survey, Atlantic House, Holburn Viaduct, London, E.C.1., U.K.
- E.B. Magrab (1975), *Environmental Noise Control*, John Wiley, New York.
- D.N. May, ed. (1978), *Handbook of Noise Assessment*, Van Nostrand Reinhold, New York.
- A. Nakano (1966), "Relation between Noise Rating Number and Objective Measurement of Machine Noise," *J Acoust Soc Ja*, Vol 22, #2, March 1966, pp 62-76.
- P.H. Parkin (1965), "On the Accuracy of Simple Weighting Networks for Loudness Estimates of Some Urban Noises," *J Sound and Vib*, Vol 2, #1, pp 86-88.
- H.O. Parrack (1957), "Community Reaction to Noise," Chapter 36 in Harris (1957).
- A.C. Pietrasanta and K.N. Stevens (1958), "Noise Exposure in Communities Near Jet Air Bases," *Noise Control*, Vol 4, #2, March 1958, pp 93-100.
- I. Pollack (1952), "The Loudness of Bands of Noise," *J Acoust Soc Am*, Vol 24, #5, September 1952, pp 533-538.
- G. Quietzsch (1955), "Objektive und Subjektive Lautstarkemessungen," *Acustica*, Vol 5, *Akustische Beihefte* #1, pp 49-66.
- D.W. Robinson (1958), "A New Determination of the Equal-Loudness Contours," *IRE Trans on Audio*, Vol AU-6, January-February 1958, pp 6-13.
- D.W. Robinson (1969), "The Concept of Noise Pollution Level," NPL Aero Report AC 38, and "An Outline Guide to Criteria for the Limitation of Urban Noise," NPL Aero Report AC 39, March 1969, National Physical Laboratory, Aerodynamics Division.
- D.W. Robinson (1971), "Towards a Unified System of Noise Assessment," *J Sound and Vib*, Vol 14, #3, Feb, pp 279-298.
- D.W. Robinson and R.S. Dadson (1956), "A Re-determination of the Equal Loudness Relations for Pure Tones," *Bri J of Appl Phys*, Vol 7, May, pp 166-181.
- D.W. Robinson, J.M. Bowsher, and W.C. Copeland (1963), "On Judging the Noise from Aircraft in Flight," *Acustica*, Vol 13, #5, pp 324-336.
- D.W. Robinson and L.S. Whittle (1964), "The Loudness of Octave Bands of Noise," *Acustica*, Vol 14, #1, pp24-35.
- W. Rosenblith and K.N. Stevens (1953), "Handbook of Acoustic Noise Control" Vol II, "Noise and Man" WADC Technical Report 52-204, PB111274, June 1953, pp 181-200.
- J. Sataloff (1957), *Industrial Deafness*, Blakiston Division, McGraw-Hill, New York.
- B. Scharf and T.J. Horton (1978), "Scaling loudness and annoyance as a function of duration," *J Acoust Soc Am*, Vol 63, #S1, Spring 1978, p517, Abstract F7.

- T.J. Schultz (1968), "Noise Criterion Curves for Use with the USASI preferred Frequencies," *J Acoust Soc Am*, Vol 43, #3, Mar, pp 637f.
- T.J. Schultz (1972), *Community Noise Ratings*, Applied Science Publishers, London.
- T.J. Schultz (1978), "Synthesis of social surveys on noise annoyance," *J Acoust Soc Am*, Vol 64, #2, Aug 1978, pp 377-405.
- M. Shimizu (1969), "A Simple Method of Measuring Loudness Level — On Automobile Noises," *J Acoust Soc Jap*, Vol 25, #6, pp 319-324.
- S.R. Silverman (1947), "Tolerances for Pure Tones and Speech in Normal and Defective Hearing," *Ann of Otolology, Rhinology, and Laryngology*, Vol 56, September 1947, pp 658-677.
- L.J. Sivian and S.D. White (1933), "On Minimum Audible Sound Fields," *J Acoust Soc Am*, Vol 4, #4, April 1933, pp 288-321.
- W.C. Sperry (1978), "Aircraft and Airport Noise" in Lipscomb and Taylor (1978).
- A. Spoor (1967), "Presbycusis Values in Relation to Noise Induced Hearing Loss," *International Audiology*, Vol 6, #1, July 1967, pp 48-57.
- D.F. Stephens and G. Rood (1978), "The Nonauditory Effects of Noise on Health" in May (1978).
- K.N. Stevens, W.A. Rosenblith, and R.H. Bolt (1955), "A Community's Reaction to Noise: Can it Be Forecast?" *Noise Control*, Vol 1, #1, January 1955, pp 63-71.
- S.S. Stevens, ed (1951), *Handbook of Experimental Psychology*, John Wiley & Sons, Inc., New York.
- S.S. Stevens (1956), "The Calculations of the Loudness of Complex Noise," *J Acoust Soc Am*, Vol 28, #5, September 1956, pp 807-832.
- S.S. Stevens (1961), "Procedure for Calculating Loudness: Mark VI," *J Acoust Soc Am*, Vol 33, #11, November 1961, pp 1577-1585.
- S.S. Stevens (1972), "Perceived Level of Noise by Mark VII and Decibels (E)," *J Acoust Soc Am*, Vol 51, #2 Part 2, Feb, pp 575-601.
- S.S. Stevens, J. Volkman and E.B. Newmann (1937), "A Scale for the Measurement of the Psychological Magnitude Pitch," *J Acoust Soc Am*, Vol 8, #3, Jan, pp 185-190.
- S.S. Stevens and H. Davis (1938), *Hearing*, John Wiley & Sons, Inc., New York.
- S.S. Stevens and F. Warshofsky (1965), *Sound and Hearing*, Time, Inc., New York.
- H.E. von Gierke and S. Yanif (1974), "Criteria for Noise Regulation," *Noise News*, Vol 3, #4, July-Aug 1974, pp 84f, 96-100.
- R.A. Waller (1969), "Office Acoustics — Effect of Background Noise," *Applied Acoustics*, Vol 2, #2, April, pp 121-130.
- S.B. Waltzman and H. Levitt (1978), "Speech Interference Level as a Predictor of Face-to-Face Communication in Noise," *J Acoust Soc Am*, Vol 63, #2, Feb 1978, pp 581-590.
- J.C. Webster (1965), "Speech Communications as Limited by Ambient Noise," *J Acoust Soc Am*, Vol 37, #4, April, pp 692-699.
- J.C. Webster (1969), "Effects of Noise on Speech Intelligibility," *Proc Conference Noise as a Public Health Hazard*, Washington, DC, June 13-14, 1968, ASHA Reports 4, The American Speech and Hearing Association, Washington, D.C., 1969, pp 49-73.
- J.C. Webster and G.L. Clubb (1974), "Speech Interference by Noise," *Proc 1974 Int Conf on Noise Control Eng*, Washington, D.C., 30 Sept-2 Oct 1974, pp 553-558.
- R.J. Wells (1969), "A New Method for Computing the Annoyance of Steady State Noise versus Perceived Noise Level and Other Subjective Measures," *J Acoust Soc Am*, Vol 46, #1 (Part 1), July, p 85.
- D.E. Winer (1979), "Airport Noise Exposure: The Problem of Definition," *Sound and Vibration*, Vol 13, #2, February 1979, pp 22-27.
- Y.F. Yerges and J. Bollinger (1973), "Manual Traffic Noise Sampling — Can It Be Done Accurately," *Sound and Vibration*, Vol 7, #12, Dec 1973, pp 23-30.
- R.W. Young (1958), "Don't Forget the Simple Sound-Level Meter," *Noise Control*, Vol 4, #3, May, pp 42f.
- R.W. Young (1964), "Single-Number Criteria for Room Noise," *J Acoust Soc Am*, Vol 36, #2, Feb, pp 289-295.
- R.W. Young (1965), "Re-Vision of the Speech-Privacy Calculation," *J Acoust Soc Am*, Vol 38, #4, Oct, pp 524-530.
- R.W. Young (1968), "Effective Duration of an Aircraft Flyover," Reports of the 6th International Congress on Acoustics, Paper F-3-11, pp F-109-112, Tokyo.
- R.W. Young and A.P.G. Peterson (1969), "On Estimating Noisiness of Aircraft Sounds," *J Acoust Soc Am*, Vol 45, #4, April, pp 834-838.
- E. Zwicker (1960), "Ein Verfahren zur Berechnung der Lautstarke," *Acustica*, Vol 10, *Akustische Beihefte* #1, pp 304-308.
- E. Zwicker, G. Flottorp, and S.S. Stevens (1957), "Critical Bandwidth in Loudness Summation," *J Acoust Soc Am*, Vol 29, #5, May, pp 548-557.

Chapter 5

Vibration and Its Effects

5.1 WHAT VIBRATION DOES.

Vibration related problems can be classified as in Table 5-1.

These problems will be discussed in the following sections on the effects on man, maintenance, vibration specifications, and other effects. The problem of excessive noise has already been reviewed.

Table 5-1

VIBRATION-RELATED PROBLEMS

Effect on man

Injury
Fatigue
Annoyance
Interference with performance

Mechanical failure

Excessive stress
Fatigue
Destructive impacts

Other

Excessive wear
Excessive noise
Inadequate performance
Failure to satisfy vibration specifications

5.1.1 Effects of Vibration on Man. The subjective effects of vibration are important to those concerned with passenger or operator comfort in automobiles, planes, boats, trains, and other vehicles. Vibration levels that are structurally safe for a vehicle are often uncomfortable, annoying or even dangerous for the occupant. Some machinery and hand tools vibrate all or parts of the body, and this vibration may affect performance as well as comfort. Sometimes buildings and floors vibrate enough to be alarming or to affect the performance of fine tasks.

Such effects have led to extensive studies, which have been reviewed comprehensively by Goldman and von Gierke (1961) and Guignard (1965, 1971). These excellent reviews, which cover the injurious levels of vibration as well as the subjective aspects, are recommended to those concerned with these problems.

The sensation of vibration is not localized as it is for hearing, since vibration can be felt throughout the body and different mechanisms operate to provide the sensation. Curves that present human responses to vibration cannot, therefore, be as complete as are the equal-loudness curves for simple tones of sound.

As an example of information that is available, Figure 5-1 shows results reported by Parks (1962) for vertical whole-body vibration that was classed by the subjects as "mildly annoying." Another contour is given as the approximate mean threshold at which subjects found the vibration unpleasant (Goldman and von Gierke, 1961). The variability of this determination is large, with a standard deviation of about +4 dB, -6 dB.

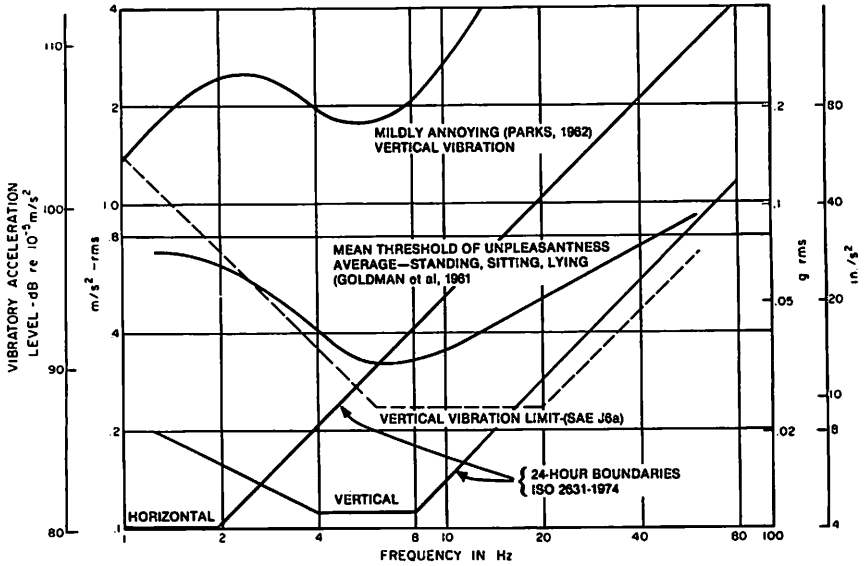

Figure 5-1. Subjective response of the human body to vibratory motion as a function of frequency (standing or sitting position).

Zepler et al. (1973) give the threshold of perception for vertical whole-body sinusoidal vibration as in the range of .001 to .05 g for 2 to 100 Hz with a mean at about .002 to .004 g.

Some comfort criteria and tolerance criteria are now in use (Goldman and von Gierke, 1961; Guignard, 1965). As an example, Janeway (SAE J6a, 1965) has prepared a chart giving recommended limits of vertical vibration for passenger comfort in automobiles. Janeway limited his analysis to data obtained for vertical sinusoidal vibration at a single frequency, with subjects standing or sitting on a hard seat. The recommended characteristic consists of three simple relations, each of which covers a portion of the frequency range. In the low-frequency range from 1 to 6 Hz the recommended limit is a fixed value of jerk. The corresponding maximum comfortable displacement at any frequency between 1 and 6 Hz is 2 divided by the frequency cubed (f^3). Over the frequency range from 6 to 20 Hz the recommended limit is a constant acceleration. The corresponding displacement is $\frac{1}{3}f^2$. From 20 to 60 Hz the recommended limit is a constant velocity, and the corresponding displacement is $1/60 f$. In each instance, the

amplitude calculated from these formulas is the maximum displacement from the static positions, expressed in inches. The limits are plotted in Figure 5-1, in terms of the rms acceleration and vibratory-acceleration level in dB re 10^{-5} m/s², rms.

Resonance effects of the internal organs and their supports, and the upper torso and the shoulder-girdle structures, probably account for the marked sensitivity to vibration in the range from 4 to 10 Hz (Goldman and von Gierke, 1961; Guignard, 1965). Many other resonances occur, however, because the body structure is so varied (Guignard, 1965). The resonances that are observed depend on the mode of excitation and the place the vibration is applied.

An international standard, ISO 2631-1974, has been developed as a "Guide for the evaluation of human exposure to whole-body vibration." This standard distinguishes three main criteria, namely:

- "a) the preservation of working efficiency ('fatigue-decreased proficiency boundary');
- "b) the preservation of health or safety ('exposure limit'); and
- "c) the preservation of comfort ('reduced comfort boundary')."

The boundaries are given as a series of charts and curves for different exposure times and directions of vibration. The 24-hour boundaries are shown in Figure 5-1. These boundaries apply to the preservation of working efficiency.

The exposure limit boundaries are suggested to be at twice those values, while the comfort boundaries are at about 1/3 the plotted values.

For reduced durations the boundaries go up in value by a multiplying factor. The range can be seen by the values shown in Table 5-2 for the frequencies of maximum sensitivity.

Table 5-2

| Exposure Duration | Acceleration — m/s ² | |
|-------------------|---------------------------------|-------------------------|
| | Vertical 4 to 8 Hz | Horizontal 1 to 2 Hz |
| 24 h | 0.112 | 0.1 |
| 16 h | 0.160 | 0.15 |
| 8 h | 0.315 | 0.224 |
| 4 h | 0.53 | 0.355 |
| 2.5 h | 0.71 | 0.5 |
| 1 h | 1.18 | 0.85 |
| 25 min | 1.80 | 1.25 |
| 16 min | 2.12 | 1.5 |
| 1 min | 2.80 | 2.0 |

These values are for a person sitting or standing. When a person is lying down, the "vertical" values apply to the foot-to-head direction of motion.

The values shown apply to rating sinusoidal motion or to the rms value of acceleration in each one-third-octave band.

Vibrations in the frequency range below 1 Hz are not rated here. Such vibrations can lead to motion sickness (kinetosis).

For a visual task, large-amplitude vibration at frequencies between 2 and 20 Hz is particularly disturbing (Guignard, 1966).

The Institute for Rapid Transit guidelines seek to prevent visual perception of vibration by limiting maximum amplitude to 0.1" peak-to-peak at any frequency. They state that car vibrations should be within the "barely perceptible" to "distinctly perceptible" area, that is, a max acceleration level of .01 g (3.8"/s/s) peak up to 10 Hz and a max velocity of .03"/s peak above 10 Hz. These measurements are made on floor, walls, and seat frames.

One of the effects of vibration occurs in some who have worked for two or more years with certain hand-held power tools. They may exhibit Raynaud's phenomenon, in which the fingers become white and numb when the person is chilled (Taylor, 1974). The incidence of this effect seems to be closely related to the vibrational energy in the frequency range from 40 to 125 Hz (Guignard, 1965).

5.1.2 Maintenance. It is widely recognized that excessive vibration leads to high costs for machinery maintenance. Conversely, gradual deterioration of machinery, for example, bearings going bad or rotors becoming more unbalanced, leads to increased vibration and noise. Recognition of this latter fact has led some groups to institute periodic vibration measurements of machinery as an important preventive maintenance procedure (Bowen and Graham, 1967; Maten, 1970; Schiff, 1970; Glew and Watson, 1971) (See section 11.2.4 & 16.5.5).

The analysis of vibration permits one to estimate the probable condition of the machine, to schedule downtime for maintenance usually before the condition gets too serious, and to tell what to look at when the machine is shut down.

If a program of this type is pursued, some acceptable limits of vibration must be set to make possible a decision as to when corrective measures must be taken. One approach is to analyze the vibration velocity at all bearing housings, when the machine is newly installed and periodically thereafter. When an appreciable change in vibration level is noted, the amount of change, the frequency region where it occurred, and the measurement location are used to decide what action if any is necessary.

These early measurements should include the vibration at the various bearing housings in all three directions, vertical and the two horizontal axes. They should be measured for the different operating conditions made possible by the various clutches and speed-changing systems on the machine. Incidentally, these early checks may occasionally reveal a faulty new machine that should be rejected and returned to the manufacturer.

Various degrees of refinement are used in spectrum analysis of these vibrations. A separation of the spectrum into the standard 8- to 10-octave bands (paragraph 8.2.1) is often adequate (Glew and Watson, 1971), but the finer divisions of the $\frac{1}{3}$ -octave (paragraph 8.2.2) (Bowen and Graham, 1967), and even an analysis into hundreds of bands by an FFT analyzer (see paragraph 8.2.4), are also used.

In addition to a history of the vibration levels for each machine, it is useful to have a type of absolute criterion, of which a number have been proposed. Among those who have proposed criteria, T.C. Rathbone (1939) was a pioneer in synthesizing the available experience in this area. The chart that he prepared in 1939 has been the basis for many subsequent specifications. This chart showed the maximum allowable peak-to-peak displacement as a function of rotation speed, with ratings varying from "Very Smooth" to "Too Rough to Operate."

One of the important points to be gained from such charts is that a simple specification of displacement or even of acceleration is not adequate for a rating, although many have assumed from physical reasoning that one of those parameters should be specified. Actually, velocity happens to be a better parameter to use for a relatively wide range of shaft speeds. For example, Rathbone has recommended some simplified upper limits of vibration that can be specified in terms of velocity for vibration frequencies above 20 Hz (1200 cycles per minute). The limits that he recommended (Rathbone, 1963) are: For power machinery, electric motors, large fans, turbines, pumps, dishwashers, dryers, vacuum cleaners, mixers, etc., the velocity should be less than 0.13 in./s, peak (110 dB re 10^{-8} m/s peak*). For hand tools, small fans, and room air conditioning equipment, the velocity, should be less than 0.1 in./s peak (108 dB re 10^{-8} m/s, peak)**. For precision machinery and business machines, the velocity should be less than .063 in./s, peak (104 dB re 10^{-8} m/s, peak).

A number of vibration charts for reference in maintenance measurements have been proposed. One proposed by Blake (1964) for process equipment is shown on Figure 5-2, where his limits have been replotted in terms of velocity. The regions bounded by the solid lines are classified by Blake as follows:

- AA. Dangerous
 - A. Failure is near
 - B. Faulty
 - C. Minor faults
 - D. No faults

These are for measurements on the bearing housing, and for equipment that is bolted down. If it is not bolted, the velocity can be increased by a factor of 2.5.

Blake applies a "service factor" to a measured velocity before using it with the chart. This factor depends on the type of equipment, and how important it is. The factor ranges from 0.3 to 2.

Another set of criteria are shown by the dotted lines (Baxter and Bernhard, 1967). These are constant velocity criteria. The regions labelled FAIR and SLIGHTLY ROUGH are regarded as transition regions, where trouble is developing.

These values do not include the effects of high-frequency vibration from bearings, or hydraulic and pneumatic vibrations.

*For the equivalent rms value (re 10^{-8} m/s, rms) subtract 3 dB; for average values (re 10^{-8} m/s avg), subtract 4 dB.

**The ratings in terms of rms values of sinusoidal vibration, as measured on some vibration meters, will be about 0.7 of these peak values; for average values (actually "average absolute"), use 0.6 of the peak values.

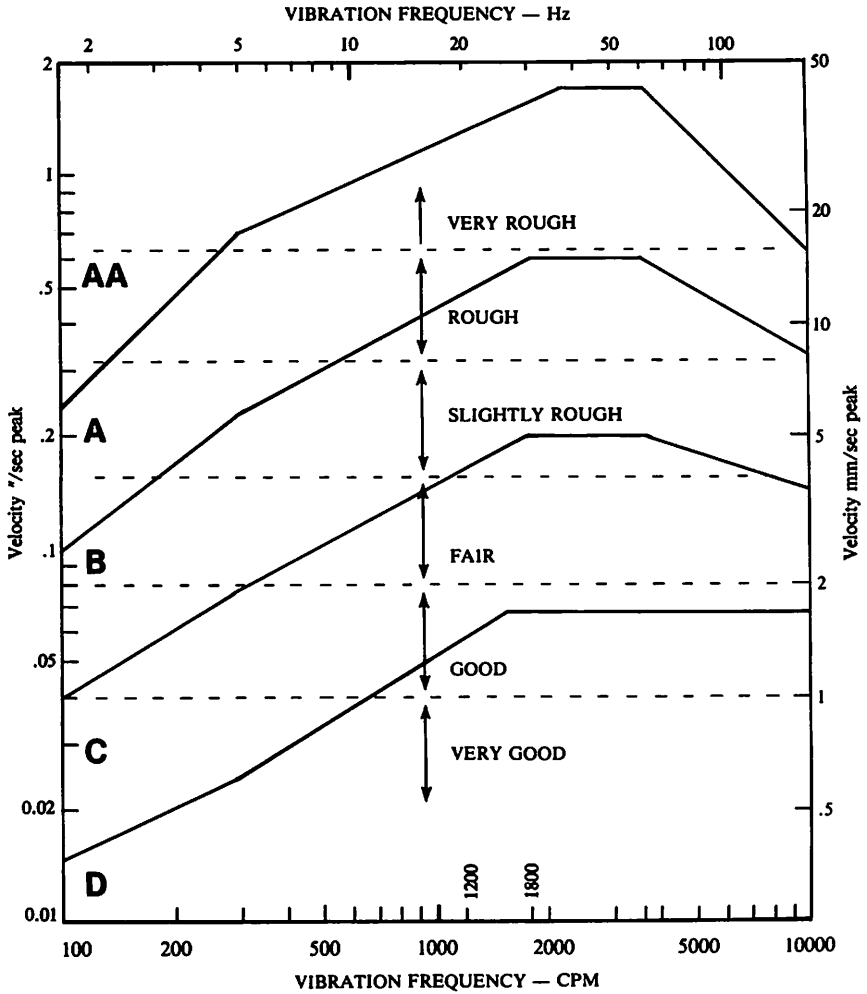

Figure 5-2 Vibration chart showing some proposed criteria for reference in maintenance measurements.

These values should be used only as a guide. Considerable variation in significance can be expected for several reasons. For example, the relation between the actual spindle or shaft vibration and the vibration measured on the associated bearing housings is complex and would not necessarily be the same for machines of the same type but of different design.

Furthermore, the vibration at a bearing housing may vary significantly around the housing because of components of different phase being introduced external to the bearing. The nature of the vibration, that is, if it is rough or random or of an impact type rather than if it is sinusoidal motion, also affects the value that is significant.

Even if no element of human reaction is involved, different criteria can be set up for the same application. Thus, the manufacturer of a compressor may select a

velocity of 0.5 in./s, peak (122 dB re 10^{-4} m/s, peak) measured on the bearing housings, as a safe upper limit, but the user may prefer to have the vibration kept to 0.1 in./s, peak (108 dB re 10^{-4} m/s, peak) or less, for best performance and low maintenance costs (cf. *Power*, Vol 109, May 1965, pp 162-164).

The manufacturer is influenced by what can be competitively produced and still have a reasonable life, but the user should be willing to pay more for a unit with the reduced maintenance costs that usually accompany lower vibration levels.

It is important to recognize that resilient mounting of a machine will not ordinarily reduce the vibration levels at the machine unless the vibration is coming from the foundation. Resilient mounting may be helpful in preventive maintenance, however, since it can reduce the effects of extraneous vibrations on the machine being measured. The vibration data from any given machine are then more representative of the condition of the machine.

5.1.3 Vibration Specifications. Limits on vibration on many machines have been set for a variety of reasons, generally on the basis of experience. For example, on a good lathe one may find a specification such as:

'Vibration to 1200 rpm (20 Hz) should not exceed 0.0005 in. on bed and 0.0003 in. at spindle.'

These are peak-to-peak measurements and the corresponding peak-velocity measurements at 1200 rpm are .03 in./s and .018 in./s. Such a specification should help to insure both high quality of work and low maintenance. But it is strange to find that many manufacturers and users of precision rotating machinery neglect such an important specification.

5.1.4 Other Effects. Many of the useful effects of vibration in chemical, biological, and physical procedures are discussed by Hueter and Bolt (1955), Crawford (1955), Bergman (1954), Frederick (1965), and Brown and Goodman (1965). The effects of machine-tool vibration have been reviewed by S.A. Tobias (1961), and metallic fatigue has been covered by Harris (1961). Many of the effects of vibration are discussed briefly in books and trade journals for the particular specialty in which the effect occurs. The handbook edited by Harris and Crede (1976) is, however, remarkably comprehensive in its coverage of the many problem areas of shock and vibration.

REFERENCES

- R.L. Baxter and D.L. Bernhard (1967), "Vibration Tolerances for Industry," *Plant Eng and Maintenance Conf*, Detroit, April 10-12, 1967, ASME, 67-PEM-14.
- L. Bergman (1954), *Der Ultraschall*, S. Hirzel Verlag, Stuttgart, Germany (6th edition).
- M.P. Blake (1964), "New Vibration Standards for Maintenance," *Hydrocarbon Processing and Petroleum Refiner*, Vol 43, #1, January, 1964, pp 111-114.
- M.P. Blake and W.S. Mitchell, eds (1972), *Vibration and Acoustic Measurement Handbook*, Spartan Books, N.Y.
- K.A. Bowen and T.S. Graham (1967), "Noise Analysis: A Maintenance Indicator," *Mechanical Engineering*, Vol 89, #10, Oct 1967, pp 31-33.
- B. Brown and J.E. Goodman (1965), *High-Intensity Ultrasonics*, Iliffe Books Ltd., London.
- A.E. Crawford (1955), *Ultrasonic Engineering*, Academic Press, N.Y.
- J.R. Frederick (1965), *Ultrasonic Engineering*, John Wiley, N.Y.

- C.A.W. Glew and D.C. Watson (1971), "The Octave Band Vibration Analyzer as a Machinery Defect Indicator," Am Soc Mech Eng Design Engineering Conf Paper, 71-DE-47, April 19-22, 1971.
- D.E. Goldman and H.E. von Gierke (1961), "The Effects of Shock and Vibration on Man," S3-W-39, American National Standards Institute, 1430 Broadway, New York, NY 10018. (Closely parallel to their Chap 44 in Harris and Crede — 1976).
- W.F. Grether (1971), "Vibration and Human Performance," *Human Factors*, Vol 13, #3, pp 203-216.
- J.C. Guignard (1965), "Vibration," Chapter 29, pp 813-894, in J.A. Gillies, ed., *A Text-book of Aviation Physiology*, Pergamon Press, Oxford.
- J.C. Guignard (1966), "Effects of Vibration on Man," *J Env Sci*, Vol 9, #4, August 1966, pp 29-32.
- J.C. Guignard (1971), "Human Sensitivity to Vibration," *J Sound and Vib*, Vol 15, #1, 8 March 1971, pp 11-16.
- C.M. Harris and C.E. Crede, eds (1976), *Shock and Vibration Handbook*, 2nd edition, McGraw-Hill, New York.
- W.J. Harris (1961), *Metallic Fatigue*, Pergamon Press, New York.
- T.F. Hueter and R.H. Bolt (1955), *Sonics*, John Wiley, New York.
- S. Maten (1970), "Program Machine Maintenance by Measuring Vibration Velocity," *Hydrocarbon Processing*, Vol 49, September 1970, pp 291-296.
- R.H. Nittinger (1964), "Vibration Analysis Can Keep Your Plant Humming," *Chemical Engineering*, Vol 71, August 17, 1964, pp 152-158.
- D.L. Parks (1962), "Defining Human Reaction to Whole-Body Vibration," *Human Factors*, Oct, pp 305-314.
- T.C. Rathbone (1939), *Power Plant Engineering*, Vol 43, #11, Nov, pp 721-724.
- T.C. Rathbone (1963), "A Proposal for Standard Vibration Limits," *Product Engineering*, Vol 34, Mar 4, pp 68f.
- I. Schiff (1970), "Vibration Analysis — Downtime Insurance," *Foundry*, Vol 98, Dec, pp 90f.
- R.W. Schoenberger and C.S. Harris (1971), "Psychophysical Assessment of Whole-Body Vibration," *Human Factors*, Vol 13, #1, pp 41-50.
- SAE J6a (1965), *Ride and Vibration Data Manual*, Society of Automotive Engineers, New York.
- W. Taylor, ed (1974), *The Vibration Syndrome*, Academic Press, London and New York.

Chapter 6

Microphones, Preamplifiers, and Vibration Transducers

6.1 GENERAL.

Sound measuring systems use a microphone (or, as a more general term, a transducer) to transform the sound-pressure variations into a corresponding electrical signal. This signal is amplified, measured and analyzed by electronic instruments.

Although some nonelectronic instruments have been used in the past for sound measurements, hardly any are used at present. The dominance of electronic techniques is a result of their versatility and extensive development and the need in acoustics for operation over a wide range of frequencies for which those techniques are well suited.

Many vibration measurements, however, are still made with nonelectronic techniques.

But the technique particularly adaptable to a broad range of applications uses a vibration pickup (also called a transducer) to transform the mechanical motion into a corresponding electrical signal. As for sound measurements, this signal is amplified, measured, and analyzed by electronic instruments.

We shall describe three types of microphones, then the electronic amplifier, called a preamplifier, which is frequently used with transducers, and, finally, vibration pickups.

6.2 MICROPHONES

Three different types of microphones are widely used for sound measurements. They are the electret-condenser type (Sessler and West, 1966; Djuric, 1972, 1977), the piezoelectric-ceramic type, and the air-condenser type.

6.2.1 Electret-Condenser Microphones. One form of electret-condenser microphone uses two plastic films, one for the diaphragm and one for supplying a bound charge (Djuric, 1977). This microphone is shown schematically in Figure 6-1. The charged plastic film is bonded to a stiff metallic backplate insulated from the microphone case. This polymer film contains an electric charge bonded to the molecules of the polymer, and it is called an *electret*. Another thin plastic film used for the diaphragm is coated with a layer of gold, and it is separated from the polymer electret by supporting elements bonded to the diaphragm. As the

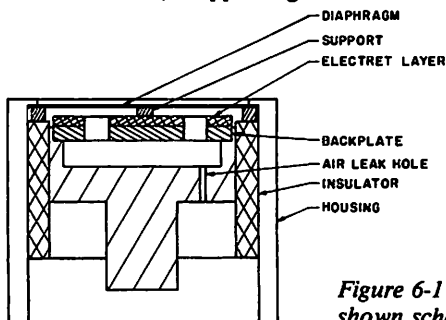

Figure 6-1 Electret-Condenser Microphone, shown schematically.

diaphragm moves in response to the sound pressure the capacitance from the diaphragm to the backplate varies. Because of the bonded charge this varying capacitance produces a corresponding electrical signal between the diaphragm and the backplate.

The electret-condenser microphone can be built to have an excellent frequency response and low sensitivity to external vibration. It is also relatively free from noise in a humid environment since there is no free electrostatic charge on the surface of the plastic film.

Two 1-inch diameter and 1/2-inch diameter electret-condenser microphones are manufactured by GenRad. Typical response-vs.-frequency characteristics for these microphones are shown in Figures 6-2 and 6-3. The responses are usually given for particular values of incidence of the sound on the microphone. For a cylindrically symmetrical microphone with the diaphragm mounted perpen-

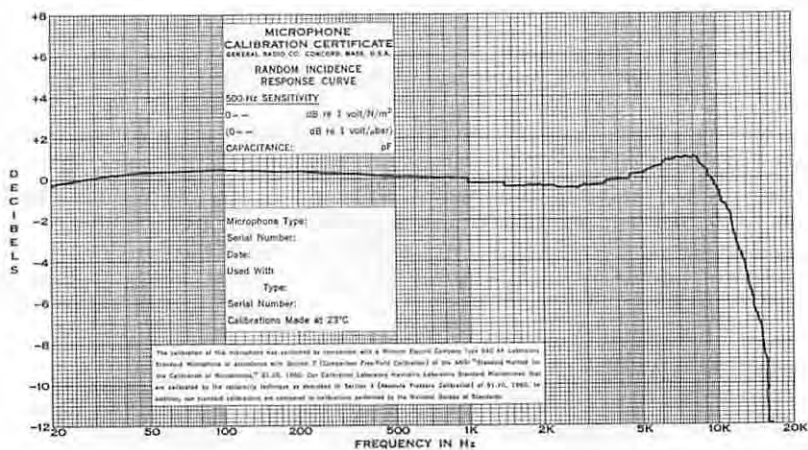

Figure 6-2. Typical Response Curve Included with GR One-Inch Random-Incidence Response Microphone.

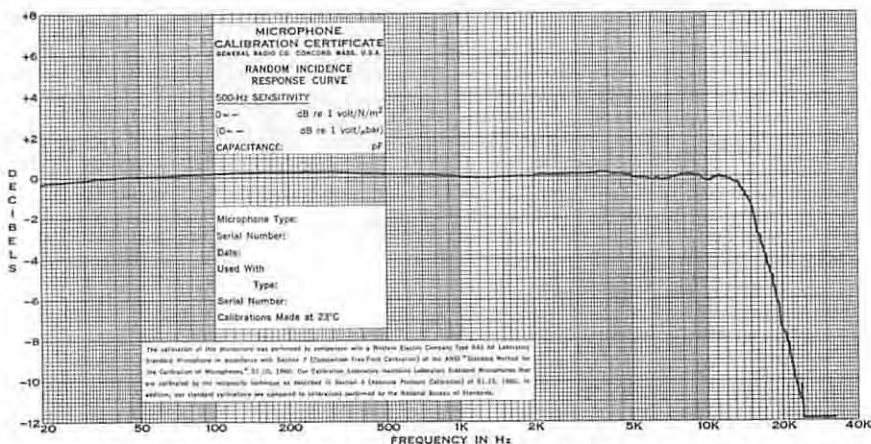

Figure 6-3. Typical Response Curve Included with GR One-Half-Inch Random-Incidence Response Microphone.

dicular to the axis of symmetry, sound propagation along the axis toward the microphone is called “0° incidence” and sometimes “perpendicular incidence.” Propagation perpendicular to the axis is “90° incidence” or “grazing incidence.”

When the angle of incidence of sound is equally likely to be any value, as is essentially the situation in a highly reverberant room, an averaged value of response is calculated from the total directivity characteristic. This averaged response is called the “random-incidence response.” It is the one used for rating response in the American National Standard for sound-level meters.

For low frequencies, as would be expected, the microphone is essentially omnidirectional, that is, the response is nearly independent of the angle of incidence. As the frequency of the sound increases, its wavelength becomes more nearly comparable with the dimensions of the microphone and directional effects are noticeable. At a given frequency the directional effect for the smaller microphone is correspondingly less than for the larger one.

6.2.2 Ceramic Microphones. The ceramic microphone uses a piezoelectric ceramic (lead-titanate, lead-zirconate) as the voltage-generating element. (The term piezoelectric indicates that the material produces a voltage when it is strained.) A diaphragm fastened to the ceramic transfers the sound-pressure variations into a corresponding varying force that bends the ceramic element (Bauer, 1957; Bonk, 1967).

This stable and rugged microphone has a smooth frequency response and is relatively unaffected by normal temperature and humidity changes. It is regularly supplied with many sound-level meters and is available for use with other measuring instruments. It can be mounted directly on the instrument or separately, with connection by extension cable when it is necessary to avoid the effects of the observer and the instrument case on the acoustical measurement.

The 1-in. size (actually 0.936 in. or 23.77 mm in diameter) is the most commonly used microphone, because it has an acceptable combination of characteristics with regard to sensitivity, frequency response, and omnidirectionality.

Typical responses for a ceramic microphone are shown as a function of frequency in Figure 6-4.

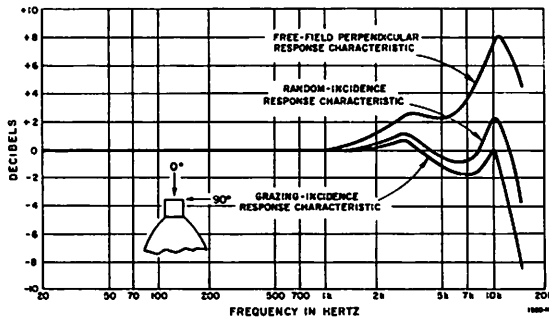

Figure 6-4. Typical Response Curves for a One-Inch Ceramic Microphone.

6.2.3 Condenser Microphones. Another type of measurement microphone is known as an air-condenser, electrostatic, or capacitor microphone (Hawley, 1955; Rasmussen, 1960, 1963). Again a diaphragm is used and it is set in motion by the sound pressure. Here the variation of an electrical capacitance, formed between the thin, stretched diaphragm and a backplate, is used to develop an electrical signal when a high polarizing voltage is applied to the capacitor. These microphones are available from other manufacturers.

Small microphones of this type have excellent response to high frequencies and are used for wide-frequency-range acoustical investigations.

These microphones have been extensively developed and studied. When properly built and carefully handled, they can provide excellent stability in sensitivity over long periods of time. They can be built to have a very small variation of sensitivity with temperature changes. Because they can also be readily calibrated by absolute methods, air-condenser microphones are widely used as laboratory standard microphones.

Because of the polarizing voltage that must be used, this microphone is susceptible to serious troubles from electrical leakage if it is exposed to high humidity. This leakage usually produces excessive background noise, and sometimes a condenser microphone fails to provide any usable signal when the humidity is high.

6.3 DIRECTIONAL RESPONSE.

The directional response of a microphone is the response at a given frequency as a function of the angle of incidence. A series of these response functions at different frequencies is shown in a polar plot in Figure 6-5. Since the microphones are essentially cylindrically symmetrical, the plot can be thought of as being rotated about the vertical axis to cover the full range of possible angles. The maximum sensitivity is at perpendicular incidence.

A measurement microphone used according to present standards is intended to be essentially omnidirectional, that is, the response is to be independent of the direction of arrival of the sound. This requirement is only approximated in practice, because of the finite size of the microphone that is needed in order to obtain satisfactory sensitivity for most measurements. Omnidirectionality is very good up to 3 kHz for one-inch and up to 6 kHz for one-half inch microphones (See Figure 6-5). Up to twice those frequencies the behavior is still satisfactory. But at 10 kHz for the one-inch and 20 kHz for the one-half-inch microphones the differences with angle of incidence are significant. If a sound being measured has much energy at frequencies in that range, then a microphone must be carefully oriented.

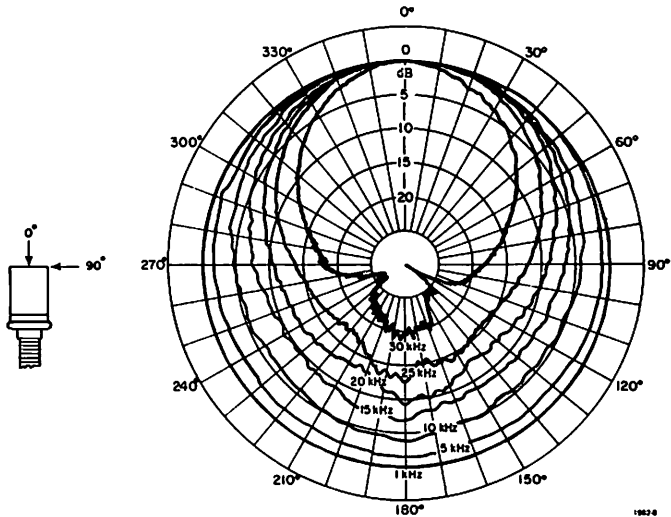

Figure 6-5. Typical directional response patterns for the GR $\frac{1}{2}$ -in. electret-condenser microphone.

In order to satisfy a variety of needs, manufacturers rate their microphones for certain angles of incidence of response characteristics (Kundert, 1978). These ratings are for random-incidence, perpendicular incidence, grazing incidence, and pressure-response. Microphones rated in this way are designed to achieve a relatively flat response-vs.-frequency for the rated incidence.

Random-incidence-response rating

The specifications in the American National Standard on sound-level meters are referenced to a random-incidence calibration. This specification has encouraged the wide-spread use of microphones designed to be as flat as possible for random incidence. The reasons for this choice are based on the practical applications for sound-level meters.

Random-incidence response is an average response in which all angles of incidence are assumed to be equally likely. In a reverberant space (with sound reflective areas), away from any discrete sources, this response is the most appropriate one to use, since reflections from many places cause sound to arrive at the microphone from many different directions.

When near a discrete source, it is desirable to set a microphone rated for random incidence so that the sound arrives at the microphone at an angle of about 70° from the perpendicular. As shown in Figure 6-6, the calibration for this angle of incidence is essentially the same as that for random incidence. The microphone will then measure the source correctly.

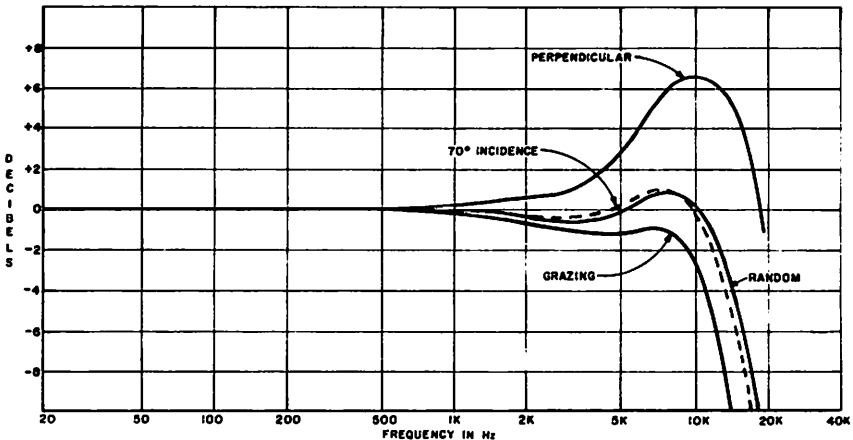

Figure 6-6. Typical responses for a one-inch diameter microphone designed for flat random-incidence response. The similarity of the random-incidence and 70° -incidence responses is apparent.

These two extremes, near a source and in a reverberant field, can therefore be satisfactorily handled with a microphone rated for random-incidence. When in the reverberant field, the orientation of the microphone isn't important. Thus, if the orientation is maintained at 70° for sound coming from a source, the microphone can be moved in and out of the reverberant field and the proper response will continue to be maintained.

In measuring community noise where sounds come from many directions and where aircraft may fly by at any distance and angle from the microphone, a random-incidence-rated microphone is useful because its response is an average

one. In general in these situations where the angle to the source is unknown, a one-half inch microphone should be used, because of its better independence of angle, provided it has adequate sensitivity.

Grazing-incidence and pressure-response rated microphones

Grazing incidence is that parallel to the plane of the diaphragm, and it is the proper one to use for measuring moving vehicles. Since the microphones are cylindrically symmetrical, the same response will be maintained as the vehicle moves by. Since this response is close to the random-incidence response (see Figure 6-6), microphones are not usually rated as being grazing-incidence microphones, and random-incidence rated microphones are used in grazing-incidence applications. Grazing incidence response is also close to what is called pressure response. The pressure response is the response that applies when a microphone is used in a small coupler or cavity, as for measuring the level produced by an earphone.

Perpendicular-Incidence-Response Rating.

Perpendicular incidence is along the axis of symmetry of the microphone (0°), which is also perpendicular to the diaphragm and is the direction of maximum sensitivity of the microphone. A microphone that is designed for flat response-vs.-frequency at perpendicular incidence, is commonly used for sound-level meters that must meet international standards. It is particularly useful in an anechoic chamber (see paragraph 13.1.3) when a small sound source is to be measured. There it has the advantage that it can be pointed at the source and any interfering sound will arrive at the microphone at an angle where the microphone is less sensitive. Furthermore, the change in sensitivity with angle of incidence is a minimum at perpendicular incidence, which makes directing the microphone less critical.

Both of these advantages apply when a microphone is to be calibrated in an anechoic chamber. Perpendicular-incidence is therefore the preferred direction of calibration by standards laboratories. A microphone rated for perpendicular incidence can be made to have a wider rated frequency range than if it is made to be rated for some other angle of incidence. This advantage can be helpful both to the user and the manufacturer.

A microphone having a flat response-vs.-frequency at perpendicular incidence is not as satisfactory for other applications as one with a flat response with random incidence. In an enclosed space or in an area with reflecting surfaces the direction of arrival of sound is not well defined, and it is usually impossible to ensure that all the significant sound energy is incident at angles near the perpendicular.

When a sound-level meter is to be held by hand, the operator should stand to the side of the path from sound source to the microphone (P. W. Young, 1962). This position is less convenient if the microphone is to be pointed at the source, than if grazing or 70° incidence is used.

6.4 TRANSDUCER SENSITIVITY

Microphone sensitivity relates the output voltage to the input sound pressure. It is usually specified at a single frequency in the range between 200 and 1000 Hz in terms of the reference sensitivity of 1-volt output for a pressure of 1 pascal or

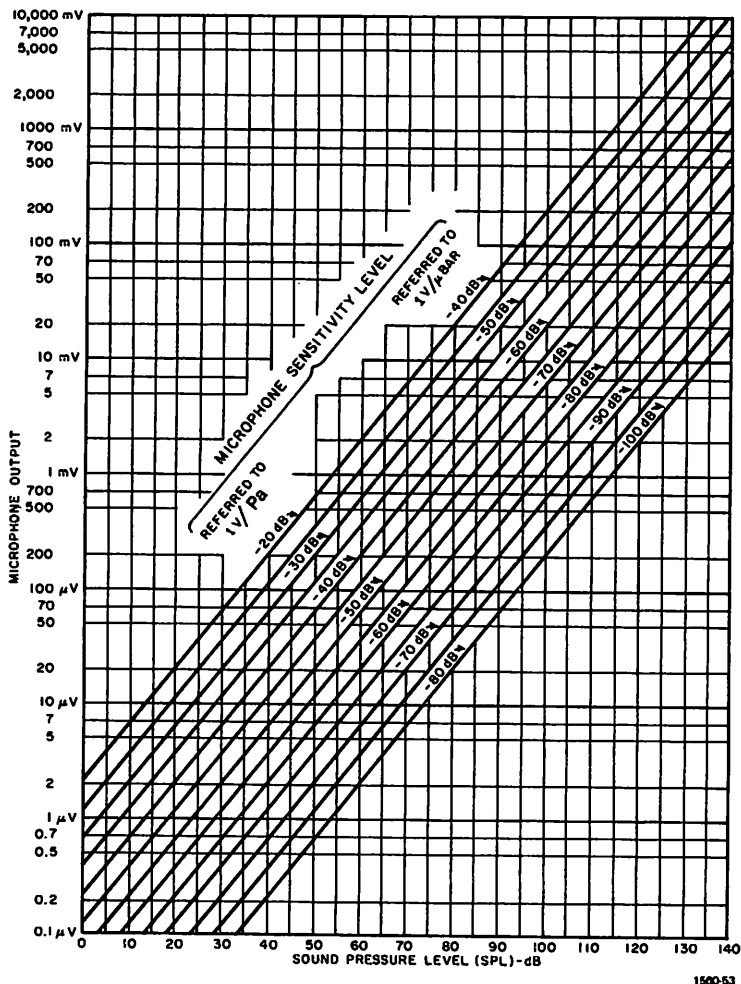

Figure 6-7. Comparative transducer sensitivity levels.

in terms of the older reference, $1 \text{ V}/\mu\text{bar}$. The apparent sensitivity levels for these two ratings differ by 20 dB; a pressure of 1 Pa corresponds to 94 dB re $20 \mu\text{Pa}$, whereas $1 \mu\text{bar}$ corresponds to 74 dB re $20 \mu\text{Pa}$. A typical microphone open-circuit (unloaded) sensitivity level is $-40 \text{ dB re } 1 \text{ V}/\text{Pa}$. If the sound-pressure level were 134 dB re $20 \mu\text{Pa}$, the open-circuit output from this microphone would be 1 V (see Figure 6-7). If the sensitivity were $-60 \text{ dB re } 1 \text{ V}/\text{Pa}$, the corresponding output would be 0.1 V, which indicates a lower sensitivity than a -40 dB microphone.

6.5 CHOICE AND USE OF MICROPHONE

The microphones supplied with modern sound-level meters are suitable for most sound measurements. For very high sound levels and for high-temperature applications, special microphones need to be used. The performance characteristics of these modern microphones, as well as their limitations, are reviewed here.

Low Sound Levels. When low sound levels must be measured, it is logical to use a high-sensitivity microphone. The higher the sensitivity, the greater will be the output voltage for a given sound level. But this higher voltage is not the only thing that needs to be considered. Another limiting factor is the internal noise in the measuring system used with the microphone. This noise should be appreciably less than the microphone output being measured in order to make a useful measurement. In a well designed low-noise system the internal noise is affected by the electrical impedance of the microphone. Thus a microphone and the associated measurement system need to be considered together to rate it for measuring low sound levels.

The measurement microphones considered here have a capacitive electrical impedance. The larger this capacitance the better will be its characteristics for keeping internal noise to a minimum. This electrical capacitance tends to increase with the size of the microphone. Since the sensitivity of a microphone also tends to increase with size, a 1-inch microphone is generally more suitable for measuring low sound levels than a ½-inch microphone (see Table 6-1). This better result is achieved at the expense of the response at high frequencies (see Figures 6-2 and 6-3). In addition the 1-inch microphone is not as omnidirectional as the ½-inch.

Table 6-1 Typical sensitivity levels and capacitance values for various measurement microphones.

| | One-inch Diameter | | One-half-inch Diameter | |
|--------------------|-----------------------------------|--------------------------|-----------------------------------|--------------------------|
| | Typical Sensitivity (dB re 1V/Pa) | Typical Capacitance (pF) | Typical Sensitivity (dB re 1V/Pa) | Typical Capacitance (pF) |
| Electret-Condenser | -38 | 63 | -40 | 24 |
| Air Condenser | -26 | 53 | -38 | 18 |
| Ceramic | -40 | 385 | | |

If the better frequency response and omnidirectionality (see paragraph 6.3) of the ½-inch microphone are not essential, the larger microphone is then to be preferred for measuring low levels. For the GR 1933 Precision Sound Level Meter and Analyzer the typical minimum measurable A-weighted level is 24 dB with a 1-inch microphone and 31 dB with a ½-inch microphone. The amplifier gain in the 1933 is also sufficient to provide an indication on the meter for such low levels. Some less versatile instruments are limited in range by the lack of adequate gain.

When a sound is analyzed, in octave or ½ octave bands, the minimum measurable sound-pressure band level is even lower than the A-weighted level, because the internal noise in a selected band is less than the overall noise.

When microphone cables are used, a preamplifier must be placed at the microphone if one must preserve the ability to measure low sound-pressure levels (see paragraph 6.7).

High sound levels. At sufficiently high sound levels the output of a microphone is no longer a satisfactory replica of the input sound pressure and the microphone is said to distort. The point at which the distortion is not acceptable depends on the type of measurement being made. But a useful measure of an upper limit is the minimum sound-pressure level at which the total distortion components with a

sine-wave input exceeds some set value. The distortion for a one-half inch electret condenser microphone is shown as a function of level in Figure 6-8. For that microphone the distortion increases rapidly above 145 dB. Condenser microphones of the half-inch size have a similar upper limit.

The system to which the microphone is connected may also limit the maximum usable level. In particular a preamplifier, if used, can readily be overloaded. This effect is discussed later in this chapter (see paragraph 6.7.1).

The distortion limit for the 1-inch ceramic microphone is above 150 dB.

If the level is too high, the microphone can be damaged. The ceramic microphone may fail at peak pressure levels of +174 dB and a negative peak pressure of 184 dB. The 1-inch electret condenser microphone should not be exposed to more than 160 dB, and the limit for the one-half inch is 170 dB.

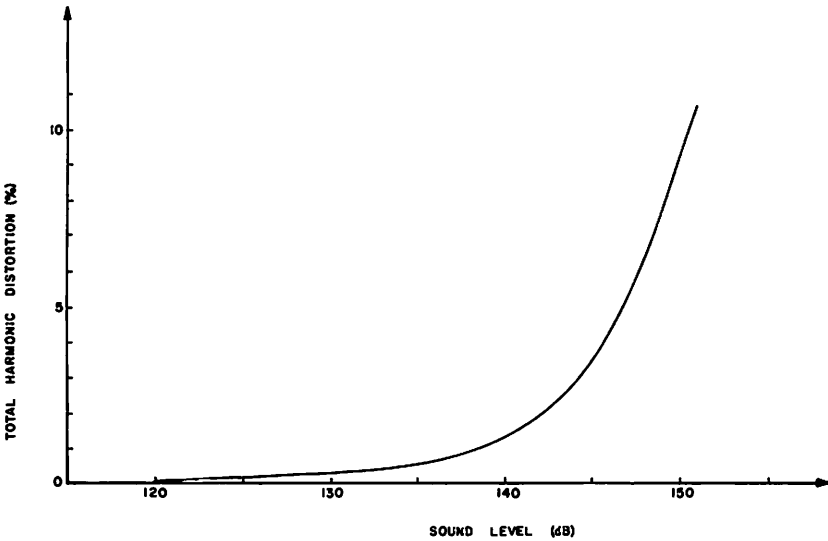

Figure 6-8. Distortion produced by a one-half-inch diameter electret condenser microphone as a function of sound-pressure level.

High-Frequency Noise. The primary requirements on the microphone for accurate measurement of high-frequency sounds are small size and uniform frequency response at high frequencies. For measuring over-all sound levels, the high-frequency characteristic is not so important because most machinery noises do not include strong high-frequency components. Even for those sounds that do include significant energy at the high-frequency end, the decrease in response required at high frequencies for the standard weightings, means that the important noise energy is generally well within the range of the regular microphone furnished on the sound-level meter.

If the noises are to be analyzed, and accurate measurement of band-pressure levels at high frequencies is important, the ½-in. electret-condenser or air-condenser microphone should be used. If good response beyond the audible range is required, a ¼-in. air-condenser or ½-in. air-condenser microphone can be used, provided the sound-pressure levels are high enough to be adequately beyond the background noise of the system.

When microphones are being compared for response at frequencies above 1 kHz, it is common to rate them in terms of the frequency limit where the response

remains within certain tolerances. In addition, the typical variations or ripples in the response characteristic below that limit need to be considered. These data for a group of microphones are shown in Table 6-2. More detail is available as individual calibration curves for a microphone and these are usually supplied with most measurement microphones.

Response at low frequencies. The response at low frequencies of the three types of microphones considered here is determined by two main factors: a "pressure equalizing leak" and the relation between the electrical impedance of the microphone and that of the input of the system to which it is connected. The pressure equalizing leak is a small hole that connects the space behind the diaphragm to the outside atmosphere. It allows the pressure on the two sides of the diaphragm to equalize at a slow rate. This equalization is necessary to allow for changes in barometric pressure and altitude. The rate at which it equalizes affects the low-frequency response. The rate is set by the diameter and length of the hole in relation to the volume of the air included behind the diaphragm. For the ceramic microphones discussed here this rate is usually such that the response is flat to about ± 1 dB at 5 Hz, and the corresponding limit for the electret-condenser microphones is 15 Hz. At still lower frequencies the response gradually decreases.

The relation of the capacitance of the microphone and associated connecting devices to the shunting resistance at the microphone, mainly from the preamplifier, also can affect the low-frequency response. With the preamplifiers available now this effect is usually less important than the overall system response at low frequencies and the effect of the equalizing leak.

Humidity. Long exposure of any microphone to very high humidity should be avoided. The ceramic microphones are not damaged by extremes of humidity.

An electret-condenser microphone can stand for long periods the normal variations in temperature and humidity without significant change in sensitivity.

An air-condenser microphone is not damaged by exposure to high humidity, but its operation can be seriously affected unless proper precautions are taken. For proper operation it is essential that very little electrical leakage occur across the microphone. The exposed insulating surface in the microphone has been specially treated to maintain this low leakage, even under conditions of high humidity. In spite of the precaution, the leakage may become excessive under some conditions. Then it may be advisable to keep the microphone at a

Table 6-2 — Upper frequency limit and ripple for various microphones.

| | Typical 1" Diameter | | Typical ½" Diameter | |
|--|---------------------------------|---------|---------------------------------|---------|
| | Upper Frequency Limit(2dB down) | Ripple | Upper Frequency Limit(2dB down) | Ripple |
| Electret-Condenser | | | | |
| Random Incidence Rating | 10 kHz | ± 1 | 20 kHz | ± 1 |
| Electret-Condenser, Perpendicular-Incidence Rating | 15 kHz | ± 1 | 25 kHz | ± 1 |
| Air-Condenser, Pressure Response Rating | 8 kHz | ± 1 | 20 kHz | ± 1 |
| Ceramic, Random- Incidence Rating | 12 kHz | ± 2 | — | — |

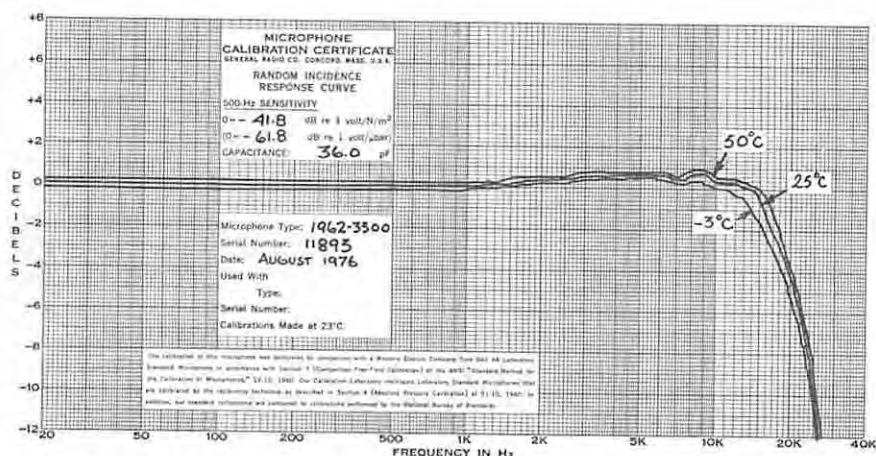

Figure 6-9. Electret microphone frequency response change with temperature.

temperature higher than the ambient temperature to reduce the leakage. In climates where the humidity is normally high, it is recommended that the microphone itself be stored at a temperature above ambient to avoid condensation.

Avoid direct condensation of moisture on any microphone. Condensation usually occurs when a cold microphone is brought into a warm area. To reduce the effect, enclose the microphone (and preamplifier, if used) in a plastic bag when cold. Let it warm up in the bag, before taking it out of the bag.

High or Varying Temperature. Although most noise measurements are made indoors at average room temperatures, some measurement conditions expose the microphone to much higher or lower temperatures. When these conditions are encountered, it is essential to know the temperature limitations of the equipment.

The ceramic microphones supplied with GenRad Sound-Level Meters will withstand temperatures of -40°C to $+60^{\circ}\text{C}$ without damage. Even at 95°C , a permanent sensitivity loss of only about 0.5 dB may occur.

The normal operating temperature range for condenser microphone systems is from -30°C to $+65^{\circ}\text{C}$. They will withstand higher temperatures without damage, but a limit of 80°C is recommended for the preamplifiers. The electret-condenser microphone should be limited to -25°C to $+55^{\circ}\text{C}$ (131°F).

Microphones are usually calibrated at normal room temperatures. If a microphone is operated at other temperatures, its sensitivity will be somewhat different and a correction should be applied. The correction for sensitivity for the ceramic microphone is only about -0.01 dB per degree Celsius, so that for most purposes the correction can be neglected. The temperature coefficient of sensitivity of the GenRad electret-condenser microphone is typically $+0.01$ dB/ $^{\circ}\text{C}$ independent of frequency below 2 kHz, and it increases slightly at higher frequencies. (see Figure 6-9).

The change in sensitivity as a function of temperature is given in Figure 6-10 for the GR 1962 Electret-Condenser Microphone. This change over the temperature range of 0 to 50°C (32 to 122°F) is about .5 dB. When necessary for precise work the value from the graph supplied for the microphone can be used to correct the sensitivity of the microphone if it is operated at temperatures significantly different from 25°C .

Since most measurement procedures include a calibration check of the acoustical measurement system before a measurement is made, it is the temperature coefficient of the calibrator that determines the system accuracy and not necessarily that of the microphone. When measurements are made at temperatures that differ appreciably from 25°C, a knowledge of the sensitivity changes with temperature of the calibrator, the microphone and the rest of the system can help reconcile any changes in calibration that occur.

The effects of temperature considered here are for gradual changes in temperature (Kundert, 1978). Sometimes microphones are subject to abrupt changes in temperature, for example, when they are brought from a warm indoor room to a low outdoor temperature. Or a warm calibrator may be placed on a microphone that is outdoors at a much colder temperature. Such thermal transients cause a temporary shift in sensitivity because all parts of the microphone are not at the same temperature during the transient change. To show the extent of the effect measurements made on a group of GR one-half-inch electret condenser microphones exposed to 0°C and lower temperatures and then suddenly brought to room temperature show a maximum sensitivity change averaging 0.72 dB occurring two to three minutes after temperature shock. Recovery to normal sensitivity was essentially completed within 30 minutes.

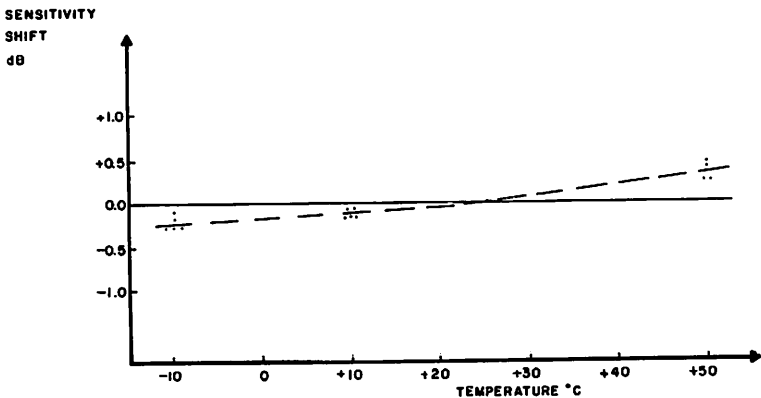

Figure 6-10. Change in sensitivity relative to that at 25°C for electret-condenser microphone as function of temperature.

Long term effects of exposure to temperature and humidity variations. In order to check the behavior of microphones over long periods when operated outdoors, ten electret condenser, four ceramic, and two air-condenser microphones were continuously exposed to the outdoor Massachusetts environment from November 1972 to March 1974 (Djuric, 1974). The microphones were unprotected except for a foamed plastic windscreen. The results for the electret and ceramic microphones are shown in Table 6-3. The maximum change for any of these was only 0.6 dB over this period that covered two winters and a New England summer. The air condenser microphones in the same environment failed catastrophically repeatedly. One of these did not recover its sensitivity after continuous exposure to warm dry air for one week, and another air condenser microphone was put in its place. At the end of the test the two remaining air-condenser microphones had changed by -1.4 and -1.0 dB.

Table 6-3 — Effect on sensitivity of exposure to the outdoor New England environment.

| Microphone Number | Sensitivity Change at 500 Hz in dB from November 1972 to | | |
|---------------------------|--|------------|------------|
| | April 1973 | Sept. 1973 | March 1974 |
| One-Inch Electret | | | |
| 1..... | 0.2 | 0.1 | 0.1 |
| 2..... | -0.2 | -0.5 | -0.5 |
| 3..... | -0.3 | -0.5 | -0.3 |
| 4..... | -0.2 | 0.1 | -0.2 |
| 5..... | 0.0 | 0.3 | 0.3 |
| Half-Inch Electret | | | |
| 1..... | 0.2 | 0.6 | 0.0 |
| 2..... | 0.1 | 0.0 | 0.0 |
| 3..... | 0.2 | 0.5 | 0.6 |
| 4..... | 0.1 | 0.3 | 0.4 |
| 5..... | 0.4 | 0.2 | -0.2 |
| Ceramic | | | |
| 1..... | 0.5 | -0.3 | 0.2 |
| 2..... | 0.2 | -0.2 | 0.0 |
| 3..... | 0.4 | -0.1 | 0.3 |
| 4..... | 0.4 | 0.2 | -0.2 |

Long-term stability under laboratory conditions.

When an air-condenser microphone is kept under laboratory conditions, its long-term drift can be significantly less than the 0.4 dB/year specified in the American National Standard Specification for Laboratory Standard Microphones, S1.12-1967. This stability has been verified by many observers, and it is one of the reasons the air-condenser microphone is widely used as a laboratory standard microphone.

Tests on electret-condenser and ceramic microphones show that under laboratory conditions, they can also satisfy the requirements of the standard. The change in sensitivity with time for some ceramic microphones are shown in Figure 6-11. Table 6-4 shows the results for a ceramic microphone when expressed in the form required by the standard. Specification of a measure of short-term stability and one of long-term stability is required. Short-term stability is described by the average drift and the sample deviation of drifts over a 5-day period. Long term stability is described by the same factors but over a one-year period. Limits on these factors are given in the standard, and these are shown in the table.

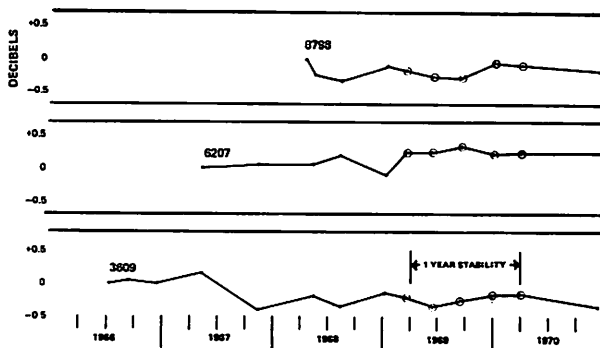

Figure 6-11. Stability record for 3 sample ceramic microphones.

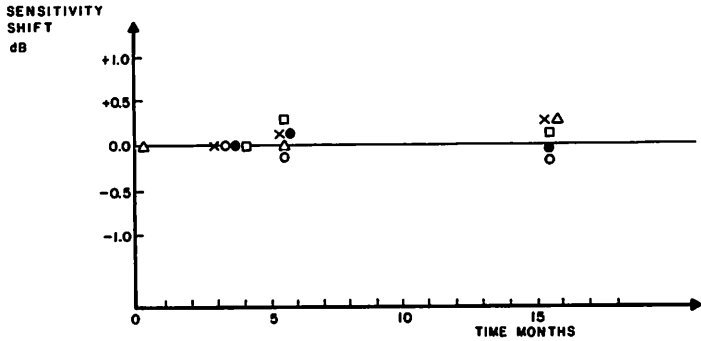

Figure 6-12. Stability record for 5 sample electret microphones.

Table 6-4

STABILITY RATING OF 1971 MICROPHONES

per procedure outlined in ANSI S1.12-1967

| STANDARD REQUIREMENT | SHORT-TERM STABILITY, 5-DAY PERIOD | | LONG-TERM STABILITY, 1-YEAR PERIOD | |
|----------------------|------------------------------------|------|------------------------------------|------|
| | m dB/day | S dB | m dB/yr. | S dB |
| TYPE 1971 | .0075 | .032 | .085 | .07 |

WHERE:

|m| = MAGNITUDE OF THE SLOPE OF CURVE OF SENSITIVITY VS TIME
 S = STANDARD DEVIATION OF RESIDUALS.

The change in sensitivity with time for a group of five GR electret-condenser microphones are shown in Figure 6-12. Again the stability is very satisfactory.

Hum Pickup. Dynamic microphones are sometimes used for measurement purposes because they are readily used with long cables. The development of modern preamplifiers, such as the 1560-P42 Preamplifier, makes the use of dynamic microphones unnecessary. But if they are used, care must be taken to avoid hum pickup, which is the induction of undesired electrical signals from the external magnetic field of equipment such as transformers, motors, and generators. Ceramic and condenser microphones are relatively free from this undesirable effect.

Long Cables. For the most accurate sound measurements, only the microphone should be put into the sound field, and the measuring instruments and the observers should not be near the point where the sound-pressure is to be measured. For this reason, and also for the situations when it is impossible or impractical for the observer to be near the microphone, an extension cable is ordinarily used to connect the microphone to the instruments. If the microphone is attached directly to the preamplifier, long cables can be used without any deleterious effects. Condenser and electret microphones should almost always be used directly on a preamplifier.

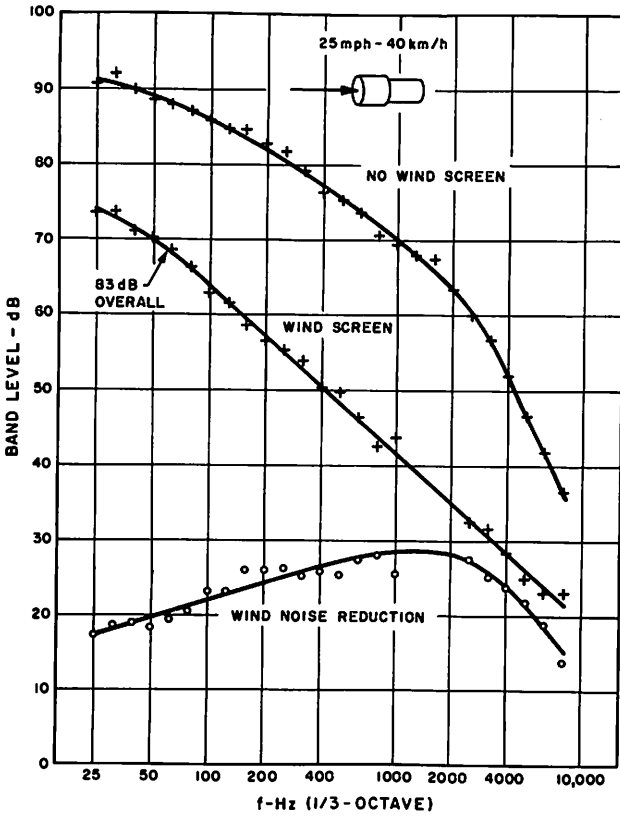

Figure 6-13a.
Wind-noise spectrum,
flat weighting.

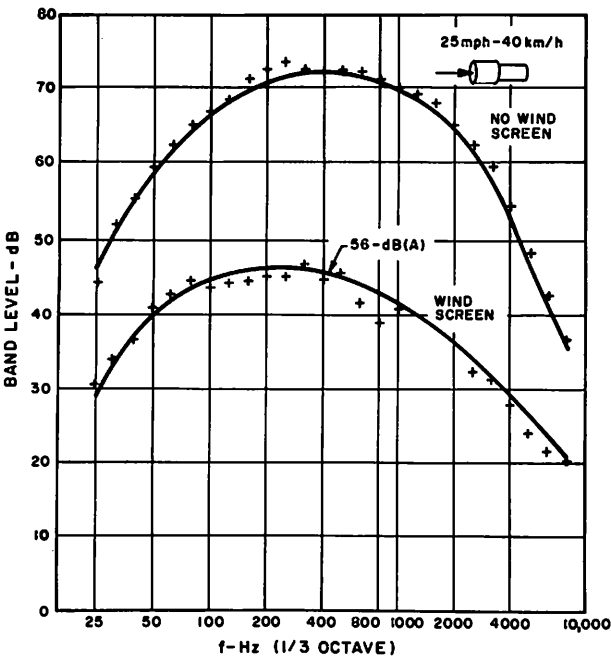

Figure 6-13b.
Wind-noise spectrum,
A weighting.

When a microphone is used directly with an extension cable, a correction for loss in sensitivity is necessary. This correction is readily determined by the use of a sound-level calibrator (see paragraph 7.5). The correction is about 7 dB when a 25-ft cable (650 pF) is used between a 1-in. ceramic microphone and the instrument, so that 7 dB should be added to the indicated level to obtain the level at the microphone. For longer cables the correction is greater.

Wind Effects. The microphone should also be kept out of any appreciable wind, if possible. Wind on the microphone produces a noise, which is mainly of low frequency as shown in Figure 6-13. This added noise may seriously upset the measurement, particularly for high wind speeds, since the noise increases with wind speed. If it is not possible to avoid wind on the microphone, a wind screen should be used. The wind screen for 1-inch microphones reduces the wind noise significantly, as shown in Figure 6-13, without a serious effect on the frequency response. Similar results are obtained with the wind screen for the ½-inch microphone.

Since the wind noise is mainly of low-frequency, the use of A-weighting reduces the over-all wind-induced noise level markedly. It is, therefore, possible that a useful A-weighted level can be measured, even though a flat or C-weighted level of the noise source is obscured by wind noise. But even here the wind screen is a desirable addition.

For measurements of noise in ducts with air flowing, wind screens need to be used to reduce the flow noise that results when the microphone is introduced into the duct (Wang and Crocker, 1974).

Sensitivity to vibration. Some vibration accompanies any sound. If the surface on which a measurement microphone is mounted is vibrating, the vibration is coupled to the diaphragm through the microphone support and its case. The output voltage caused by the vibration-induced signal will combine with that produced by the sound signal. Under certain unusual conditions a significant error in the measurement of the air-borne sound will result. This error may be significant mainly with relatively insensitive microphones, such as, the so-called “blast” type. In contrast the electret-condenser microphone is relatively insensitive to interference from this effect. But one should be aware of this possibility and support any microphone in a way that avoids vibrating it.

Vibration sensitivity is usually given as the equivalent sound level that will be produced by a vibration applied perpendicular to the plane of the diaphragm with an acceleration of 1 g (the acceleration of gravity). But the vibration of the floors even in severe environments is generally much less than 1 g. Typical vibration sensitivities for some measurement microphones are shown in Table 6-5.

Table 6-5. Sensitivity to vibration of some measurement microphones.

| Microphone | Equivalent SPL for 1 g acceleration — dB re 20 μ Pa | |
|--------------------|---|------------------------|
| | One-inch diameter | One-half-inch diameter |
| Electret Condenser | 83 dB | 83 dB |
| Air Condenser | 88 dB | 88 dB |
| Ceramic (GR1971) | 100 dB | |

Effect of atmospheric pressure. Changes in atmospheric pressure will produce changes in microphone sensitivity, but these effects are small for the usual changes in barometric pressure. For a pressure drop from 1 to 0.9 atmospheres the sensitivity of the 1-inch ceramic microphone increases about 0.1 dB, that of the 1-inch electret-condenser microphone increases 0.2 to 0.3 dB for the unit designed for uniform random-incidence response and 0.3 to 0.4 for the unit designed for uniform perpendicular-incidence response. The sensitivity of the 1-inch electret condenser microphone increases 0.2 to 0.3 dB with a pressure drop to 0.5 atmosphere. When the pressure increases above normal atmospheric pressure, the microphone decreases in sensitivity to a similar extent.

Mechanical Dimensions. The mechanical structure of a measurement microphone should be carefully controlled. This control helps ensure uniformity of performance as well as better reproducibility of measurements, particularly when the microphone is mounted in a coupler. For example, the diameter of the GR 1961 Electret-Condenser microphone is $23.77 \pm .050$ mm ($0.936 \pm .002$ in.) as required by ANSI standard S1.12-1967 for a nominal one-inch diameter standard microphone. (The .936-inch dimension for standard microphones has been used for many years, and it is conveniently referred to as "one-inch.") The internal dimensions are also carefully controlled to maintain the front volume of the microphone at a fixed value.

6.6 HYDROPHONES

Microphones used for underwater sound measurements are called hydrophones (Figure 6-14). They generally use piezoelectric ceramics as the sensitive element (Tucker and Gazey, 1966). Various types of hydrophones are available from such companies as Atlantic Research, Chesapeake Instrument Corporation, Clevite Ordnance, Gulton Industries, Scientific-Atlanta, and Wilcoxon Research.



Figure 6-14. A typical hydrophone.

6.7 PREAMPLIFIERS AND CONNECTING CABLES

When accurate sound measurements must be made, it is customary to station the instruments and the observer at some distance from the point at which the sound is to be measured (see paragraph 12.2). A connecting cable is then used to connect the microphone at that measurement point to the instruments. In addition, a small amplifier, called a preamplifier, is often used to take the signal from the microphone and transfer it to the cable. This procedure avoids the possible deleterious effects of the cable on the performance of the microphone.

6.7.1 Preamplifier. The preamplifier shown in Figure 6-15 is a high-input-impedance, low-noise amplifier (Marteney, 1970). It is particularly well suited for amplification of the output of capacitive sources, such as electret-condenser, ceramic and condenser microphones and piezoelectric vibration pickups, and for

use with sound-level meters and analyzers when a long cable must be used between the microphone and the instrument. A gain of 20 dB (10:1) is available for increasing the ultimate sensitivity of analyzers for low-level measurements.

The preamplifier shown can also provide a 200V polarizing voltage for an air-condenser microphone. It obtains its own power from another instrument or a separate supply.

It also has insert terminals, which permit the insertion of a known electrical signal as a calibrating signal in series with the microphone.



Figure 6-15. A typical field installation for microphone use. The tripod mount is shown supporting a Type 1560-P42 Preamplifier, into which a 1/2-inch microphone has been plugged. The foam sphere at the top is a windscreen that fits over the microphone to permit accurate measurements outdoors.



Figure 6-16a. Unity gain preamplifier for electret-condenser and ceramic microphones.



b. Preamplifier for ceramic microphone.

The output of the preamplifier is designed to drive long cables. For most microphone cables of less than 150 meters (500 feet) the cable will not limit the performance of the preamplifier in the audio range. For longer cables at high audio frequencies, the maximum output signal from the preamplifier is reduced, and the response is not independent of frequency.

The preamplifier shown in Figure 6-16a, the GR 1972-9600, is a simpler preamplifier with unity gain for electret-condenser and ceramic microphones. (It does not provide any polarizing voltage for air-condenser microphones.)

The preamplifier shown in Figure 6-16b, the GR 1560-P40, is a preamplifier for the 1-inch ceramic microphone. It also has a choice of 10:1 gain or unity gain. Its input impedance is high and the internal noise is low.

Distortion. Preamplifiers will distort the applied signal when the signal is high enough. For most operating conditions in the audio frequency range the output voltage is usually limited to 5 to 10 volts total swing. Since a gain setting of unity should be used at high levels, the input voltage limit is the same as the output limit. If the input signal is sinusoidal the corresponding rms voltage limits are about 1.7 to 3.5 volts. The equivalent sound pressure level depends on the sensitivity of the microphone. Thus for a one-half-inch electret-condenser with a sensitivity of -40 dB re 1V/Pa, the chart of Figure 6-7 shows that 3.5 volts corresponds to about 145 dB sound pressure levels. As pointed out previously in paragraph 6.5, the microphone itself starts to distort significantly at that level.

6.7.2 Multichannel Amplifier. Many sound and vibration measurements can be simplified by use of a scanner that connects, in sequence or in any arbitrary order, the outputs from a number of transducers to a single metering or analyzer system. The unit shown in Figure 6-17 scans up to 16 channels and amplifies each.

Figure 6-17. The Type 1566 Multi-channel Amplifier shown mounted in a field transportable automatic sound analysis system in which it scans the inputs of up to 16 remote microphones.

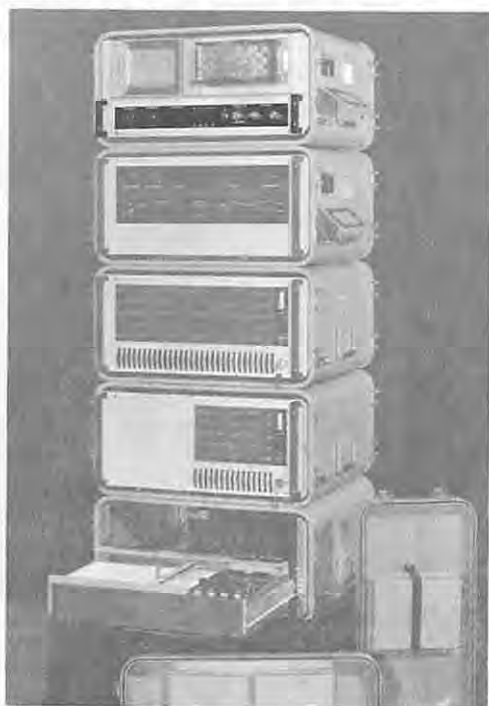

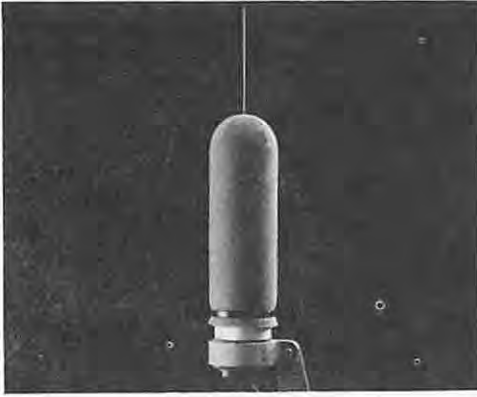

Figure 6-18. Weatherproof microphone system.

6.7.3 Microphone Mounting. A microphone and preamplifier is often best suspended in position by its connecting cable. When this arrangement is not possible, a tripod with suitable adaptor devices can be used to hold the microphone in the desired position (see Figure 6-15).

Outdoor Microphone System. The GR 1945 Weatherproof Microphone System, shown in Figure 6-18, is designed to protect in an outdoor environment the GR 1560-P42 Preamplifier and a microphone, such as the GR electret-condenser or ceramic microphone, which is selected separately. It is well suited for community noise measurements, noise monitoring of aircraft, and other outdoor applications where measurements are made under a variety of conditions.

The protective features include a bird-deterrent spike, and a rigid, perforated stainless-steel shield covered by a rain screen. Inside the shield are a wind screen for the microphone and a preamplifier housing that includes a desiccant cartridge. A mounting mast is also included.



Figure 6-19. Vibration integrator system.

6.8 VIBRATION PICKUPS

The vibration pickup supplied by GenRad, as shown in Figure 6-19, is an inertia-operated, lead-zirconate, lead-titanate, piezoelectric device that generates a voltage proportional to the acceleration of the pickup (Dranzet and Orlacchio, 1976; Carlson, 1952). Voltages proportional to velocity and displacement of the vibrating body are also obtainable by the use of electronic integrating networks to convert the voltage generated by the pickup. This type of pickup has the advantage of small size, light weight, and wide frequency range, and it does not require a fixed frame of reference for the measurement.

The sensitivity of an accelerometer is commonly rated in terms of open-circuit (unloaded) output in millivolts (.001 V) for an acceleration that corresponds to that of gravity (g). Since the acceleration of gravity (9.80665 m/s^2 or 386.09 in./s^2) is always directed toward the center of the earth, an alternating acceleration rated in terms of "g" units is to be interpreted as a use of the numerical value only. As such, it is sometimes used for the peak value of a sinusoidal acceleration or the rms value (0.707 times the peak for a sinusoidal vibration). As long as it is recognized that the electrical output and the acceleration are to be measured in the same way, rms and rms, or peak and peak, it is not necessary to specify in the sensitivity statement which is meant; the numerical sensitivity should be the same for both.

The relations among velocity, displacement, and acceleration depend on the frequency as well as the amplitude (Appendix IV). To find the transducer output for a given frequency and velocity or displacement, convert the vibration to the equivalent acceleration (Appendix IV, Figure IV-1 and IV-2), and then the chart of Figure 6-20 can be used.

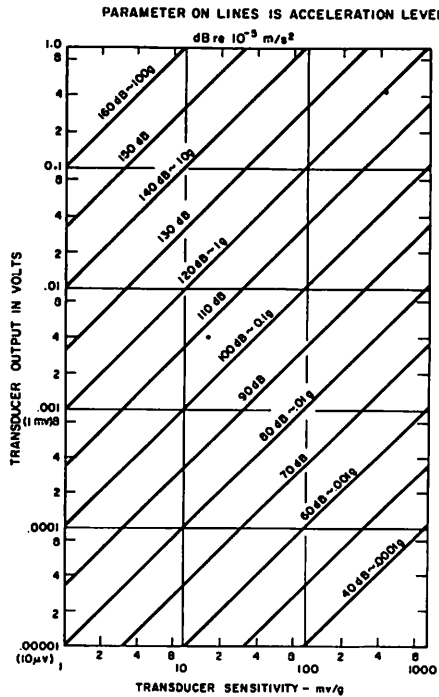

Figure 6-20. Chart to determine transducer output for various acceleration parameters.

REFERENCES

- B.B. Bauer (1957), "Microphones for Sound-Level Meters," *J Acoust Soc Am*, Vol 29, #12, Dec, pp 1333f.
- B.A. Bonk (1967), *General Radio Experimenter*, Vol 41, #5/6, May/June, pp 3-8.
- E.V. Carlson (1952), "A Ceramic Vibration Pickup," *Trans IRE Prof Group on Audio*, PSA-10, Nov-Dec 1952, pp 2-8.
- A. Dranetz and A.W. Orlacchio (1976), "Piezoelectric and Piezoresistive Pickups," Chapter 16 in Harris and Crede (1976).
- S.V. Djuric (1972), "Electret Condenser Microphones for Measurement," *J Acoust Soc Am*, Vol 51, #1, Part 1, Jan 1972, p 129.
- S.V. Djuric (1974), "Comparative Outdoor Tests of Measurement Microphones," *J Acoust Soc Am*, Vol 55, p S30(A), 05, April 1974.
- S.V. Djuric (1977), "Recent Improvements in Measurement-Grade Electret-Condenser Microphones," 9th International Congress on Acoustics, Contributed Papers, Vol II, Q35, Madrid, 4-9 July 1977.
- C.M. Harris and C.E. Crede (1976), *Shock and Vibration Handbook*, Second edition, McGraw-Hill, N.Y.
- M.S. Hawley (1955), "The Condenser Microphone as an Acoustic Standard," *Bell Laboratories Record*, Vol 33, #1, Jan 1955, pp 6-10.
- W.R. Kundert (1978), "Everything you've wanted to know about measurement microphones," *Sound and Vibration*, Vol 12, #3, March 1978, pp 10-23.
- E.R. Marteney (1970), "A Big Little-Brother Preamplifier," *General Radio Experimenter*, Vol 44, #10-12, Oct/Dec, p 8.
- G. Rasmussen (1960), "Pressure Equalization of Condenser Microphones and Performance at Varying Altitudes," *B & K Technical Review*, #1, pp 3-23.
- G. Rasmussen (1963), "Miniature Pressure Microphones," *B & K Technical Review*, #1, pp 3-10.
- G.M. Sessler and J.E. West (1966), "Foil-Electret Microphones," *J Acoust Soc Am*, Vol 40, #6, Dec 1966, pp 1433-1440.
- D.G. Tucker and B.K. Gazey (1966), *Applied Underwater Acoustics*, Pergamon Press, Oxford, Chapter 5.
- J.S. Wang and M.J. Crocker (1974), "Tubular windscreen design for microphones for in-duct fan sound power measurements," *J Acoust Soc Am*, Vol 55, #3, March 1974, pp 568-575.
- C.A. Woodward (1965), "A New, Low-Noise Preamplifier," *General Radio Experimenter*, Vol. 39, #6, June, pp 1-6.
- R.W. Young (1962), "Can Accurate Measurements be Made with a Sound-Level Meter Held in Hand?" *Sound*, Vol 1, #1, January-February, pp 17-24.

Chapter 7

Sound-Level Meters & Calibrators

7.1 SOUND-LEVEL METERS.

The basic instrument of a sound-measuring system is the sound-level meter. It is a portable meter for reading in terms of a standard reference pressure ($20 \mu\text{Pa}$) the sound level at its microphone. Fundamentally, the instrument consists of an omnidirectional microphone, a calibrated attenuator, weighting networks, a stabilized amplifier, a squarer, an averaging circuit, and an indicator. The networks provide the three common sound-level meter responses, A, B, and C (see Figure 2-3).

Four types of sound-level meters are specified in the latest American National Standard Specification for Sound-Level Meters, S1.4-1971. These are called Types 1, 2, 3, and S or "Precision," "General Purpose," "Survey" and "Special Purpose," respectively. The first three types differ in their performance requirements, with the requirements being most strict for the Type 1 or Precision Sound Level Meter and progressively less strict for the types 2 and 3. The special-purpose sound-level meter is one that meets the requirements of one of the other types, but does not contain all three weighting networks.

The international standard IEC 651-1979, Instruments for the Measurement of Sound Level, specifies four degrees of precision: Types 0, 1, 2, 3. Type 0 is intended as a laboratory reference standard. Type 1 tolerances are similar to those of Type 1 in ANSI S1.4-1971. Specifications for meters intended to measure impulse sounds are also included in this IEC standard.



Figure 7-1. Sound-level meters (l.r.) Type 1981-B Precision (ANSI Type S1A), Type 1982 Precision SLM and Analyzer (ANSI Type 1), Type 1565-B (ANSI Type 2), Type 1983 (ANSI Type S2A).

The A, B, and C weighting characteristics specified in these standards are shown in the graph of Figure 2-3, and Tables 12-2 and 12-3 list the characteristics and tolerances for A and C weightings from ANSI S1.4-1971. In addition, a response that is essentially independent of frequency is often included in a sound-level-meter and labelled 'FLAT.' This response is used for measurement of sound pressure level or when the sound-level meter is used to supply a signal to an analyzer. As explained earlier the A-weighted response is the one most widely used for sound-level measurements. It is the weighting that is commonly available in Type S instruments.

The Type 1 or "Precision" instrument is widely used in the laboratory where conditions can be carefully controlled and the accuracy of the instrument can be fully used. Because some Type 1 instruments are readily portable and easy to use, see Figure 7-1, they are also widely used for field measurements. The accuracy of the Type 1 instruments is thus sufficient that the measurement conditions are the determining factors of the quality of the measurement, particularly if a precision impulse sound level meter is used (see paragraph 7.2).

Some modern sound-level meters have both an analog indicating meter and a digital display for the sound level. A digital display adds flexibility to the output indication since it can display the maximum level while the indicating meter shows the current level. Type 1981 and 1982 Precision Sound Level Meters provide this feature. It is particularly helpful in measuring traffic noise.

The digital display also is easier to read without error. It is less satisfactory when levels are fluctuating widely if the FAST response is used. On some instruments instantaneous values can be selected by the press of a button to capture and hold the reading. This permits ready sampling of the fluctuating level.

Some instruments provide a very wide display range of 50 dB on the indicating instrument. Since many noises vary in level with time over a wider range than the 15 to 20 dB commonly used in many instruments, the increased range on the indicating instrument avoids the frequent range switching that is otherwise necessary. The full range of 50 dB can be obtained with nicely uniform divisions, which makes it easy to read (see Figure 7-1). When a single event is to be measured, such as a vehicle pass-by, the user is less likely to miss the reading because the wrong range was selected.

7.1.1 Detectors, Squaring, RMS, Peak. The pressure values used in previous paragraphs were stated without indicating how they were derived from the pressure wave. In order to explain what values might be used, consider the sine wave shown in Figure 2-5. This wave could represent the sound pressure as a function of time at the diaphragm of a microphone if the sound were a pure tone. The average* value is taken as the base with the sound pressure oscillating above and below that base. The peak value, A, which is also called the amplitude, would appear to be a useful value to use in characterizing the pressure wave. Sometimes it is. If questions of distortion or physical damage are important, then the peak value can be useful. But for reasons to be examined shortly, what is called the "root-mean-square" or "rms" value is more frequently used.

"Root-mean-square" (rms) can be understood by considering first "mean square." A mean-square value of a wave is an average (mean) of the squares of the instantaneous values of the wave over a period of time. If we are concerned with a pressure wave, the mean-square value is then a pressure-squared value. To

*This "average" merely refers to the existing atmospheric pressure, and it is not the "rectified average," which was used in the past but is now rarely used.

convert back to pressure, the square-root of the mean-pressure-squared value is then taken. The root is taken, since it often seems more convenient to think of the behavior of sound in terms of pressure rather than of pressure squared. When the root-mean-squared pressure is converted to a decibel level, the procedure of paragraph 2.4 (Sound-Pressure Level) is used. Alternatively, the decibel level can be calculated from

$$L_p = 10 \log \frac{\overline{p^2}}{P_o^2} \text{ dB re } 20\mu\text{Pa}$$

where $\overline{p^2}$ is the mean-squared pressure and $P_o = 20\mu\text{Pa}$.

One of the reasons that the rms value is used is that, regardless of the waveform of the sound, the squared rms pressure is proportional to the average power in the sound wave. Thus waves of different shape, for example, a pure tone and a random noise, can be logically compared for apparent power if other conditions are the same. If the peaks of the waves were used, such a comparison could be quite misleading. This discrepancy can be appreciated from consideration of a variety of waves and their corresponding ratios of the peak value to the rms value. This ratio is called the "crest factor." A sine wave has a crest factor of $\sqrt{2} \approx 1.414$. A random noise has an indeterminate crest factor; frequently, a value of 4 or 5 is used as a reasonable value. Impulse type sounds may have still higher crest factors. Typewriter impact noise, A weighted, can be 6 or more. The corresponding level difference is about 15 dB.

Another reason for the use of rms relates to summing sounds. Again if waves of different shapes* from two different sources are to be added at a point, the squares of the individual rms pressures can be added to obtain a reliable value for the resulting mean-squared pressure. Such a result does not necessarily follow if peak values were used.

Still another reason for the use of rms relates to the analysis of a sound into its components. This analysis is explained in more detail in Chapter 8, but, in principal, over a finite time interval any complex sound can be regarded as being composed of a number of pure tones. The sums of the squares of the rms values of the component tones will be equal to the square of the rms value of the complex sound. This result is a useful one in studying components, and no such simple relation holds for peak values or any measure other than mean-square or rms.

7.1.2 Averaging, Exponential and Linear. "Mean" or "average" has been used previously without definition. Actually several different types of averaging are used in sound measurements. One of the simplest in concept is to average with equal weight the pressure-squared values over a fixed interval of time. This average is sometimes called "linear." It is not often available on sound measuring instruments, but it does have the advantage that all the data in the interval are fully included in the result.

An average that is more widely used is often called an "exponential" average. It is a type of "running" average. New values are combined with old results, but the older results are weighted to reduce their influence as they are combined. Thus, the new data dominate the average. In normal operation, the average is taken continuously, and the average tends to follow the changing level of sound. This type of averaging can be done with a resistance-capacitance network in an electrical circuit, and, consequently, it is commonly called "R-C averaging."

*The waves should not contain components of the same frequency.

The rate at which older data are suppressed is important in determining the behavior of the indicated average. In a sound-level meter two averaging rates are supplied, "FAST" and "SLOW." "FAST" has a time constant of about $\frac{1}{4}$ second and SLOW, about 1 second. When the sound being measured is steady, the two rates yield the same result. But if the sound keeps changing in level, it is easy to observe how the two rates differ in their effect on the behavior of the indicating instrument.

A common example that illustrates the difference is the behavior in measuring automobile pass-by noise. The reading of the indicator will rise and then fall as the automobile passes by. The rate at which it rises and falls will depend not only on the speed of the automobile, but also on the sound-level meter time constant selected. The maximum value shown by the indicator may also depend on the time constant chosen. Note that this maximum value is different from the "peak" instantaneous value shown earlier. In sound-level meter measurements the term "maximum" is usually reserved for this maximum that is observed during a running average.

With an impulse-type noise, such as that from a punch press, a drop forge, or a gun blast, the difference in the maximum observed reading for "FAST" and "SLOW" can be many decibels. Neither average is fast enough to follow the rapid changes in level. For some purposes it appears helpful to modify the sound-level meter characteristics even further for impulse noise and that has led to the impulse type of detector discussed next.

7.2 IMPULSE-NOISE MEASURING INSTRUMENTS.

Impulse-type noises, such as those produced by punch presses, drop hammers, riveting machines, and typewriters, cannot be properly measured by the simpler sound level meters (Kundert, 1974). The Types 1933 and 1982 Precision Sound-Level Meters and Analyzers have been specially designed to handle such sounds as well as the non-impulsive types.

The impulse-type sound level meter must have remarkably good behavior over a wide range of levels in order to provide accurate measurements of impulsive sounds. This behavior must be achieved without the delay of switching ranges or of switching other characteristics and for that reason the usable range of levels under these conditions is often called "dynamic range." Because of these good characteristics the impulse-type sound-level meter is generally the most versatile sound-level meter.

The 1933 and 1982 instruments also include an impulse mode that does a short-time average of the squared signal. It has a fast rise time and a slow decay. The actual characteristics selected are based mainly on work done in Germany where an attempt to relate measured values to subjective loudness judgments of impulsive sounds (Niese, 1965) led to the development of a special detector system. Although general agreement on the value of this detector has not been obtained in its relation to estimating subjective responses, it has been standardized (IEC 651-1979). It can be helpful in assessing the general effect of noise control measures on impulsive sounds.

These sound-level meters also include a "peak" mode. This measure is particularly appropriate for some vibration measurements, but it also provides an additional measurement for rating a short duration sound. When physical damage may occur, it is often useful to know the absolute peak value of a noise or vibration. That value may be more significant for determining the hazard than an energy-related measurement, at least for short impulses rather than for long exposure periods.

7.3 SAMPLING AND INTEGRATING SOUND LEVEL METERS.

7.3.1 Community-Noise Analyzer. Suppose that a manufacturer in an industrial zone needs to install some new, noisy machines. How much noise isolation is required to avoid complaints from a nearby residential area? The local power company is planning to build a small substation in a growing suburb. What noise ratings should the company specify for the equipment, and what type of enclosure will be needed? A highway is to be re-routed; what will be the impact on the community? A builder is planning to build a number of houses near a small airport. Will this development lead to many complaints about noise from those who buy the houses.

For such problems it is essential to know the present noise exposure of the area and to estimate the future exposure. As explained in Chapter 4, a number of ways are available for measuring the noise exposure. The choice of which one to use may depend on the nature of the problem, but there is growing acceptance of the day-night average sound level, L_{dn} , for most of these applications (see paragraph 4.12).

If one expects to get a good measure of widely varying community-noise levels as well as the background levels in a community, many samples of the noise need to be measured. In order to avoid missing anything important, one might assume the sampling should be done every few seconds or even more often. Suppose it is decided to measure the A-weighted sound level every 10 seconds for 24 hours. It is then necessary to combine 8,640 values to obtain L_{dn} , or to sort these values to find L_{10} , L_{50} , and L_{90} (see paragraphs 4.11-4.13). Obviously, it is a real problem to do this sampling and calculation manually.

Since measurements for more than one day are often essential in order to ensure that a reasonably representative day's exposure can be selected, manual observation becomes even less practical.

To make these measurements more practical, one can go to automatic instruments that do the job directly, change the sampling procedure to keep the number of samples within reason, or use a combination of recording and computing techniques. All these approaches have been used. But when many such measurements need to be made, the automatic instruments, such as the GR 1945 Community Noise Analyzer, shown in Figure 7-2, are easily seen to be the proper choice.



*Figure 7-2. GR 1945
Community Noise Analyzer.*

This analyzer consists of a sound-level meter, timer, sampler, memory, and processor. It will accumulate data for the various exceedance levels; L_{eq} and L_{dn} , as well, will be shown on a digital display on command.

Its internal clock can be set to start the accumulation of data at a selected time and continue for a selected time up to 24 hours. Two more sets of data can be set to accumulate for selected times immediately following the first set. This programming feature, the weatherproof microphone (Figure 6-18), battery operation, and the vandal-resistant case (Figure 7-3), make it possible to use this instrument unattended. For such an application, mounting on a pole is usually desirable.



Figure 7-3. The vandal-resistant case for protection of the 1945 Community Noise Analyzer.

7.3.2 Dosimeters. Dosimeters, described in paragraph 3.4.1, integrate a function of sound-pressure with time, usually for assessing personal noise dose. The GR 1954 Personal Noise Dosimeter can be set to integrate the square of the A-weighted sound pressure with time. The unit can then be used over a limited range to measure a value that can be converted to equivalent level when the integration time is known.

7.4 TEMPERATURE EFFECTS ON SOUND-LEVEL METERS.

Although a microphone is ordinarily subjected to the temperature of the location where the sound is to be measured, it is usually possible to keep the sound-level meter itself at more reasonable temperatures. Sound-level meters are normally rated for operation from -10°C to $+50^{\circ}\text{C}$, but they can be stored over a much wider range if batteries are removed.

7.4.1 Temperature effects on batteries. Since most sound-level meters, dosimeters, and calibrators are battery operated, it is important to recognize the limitations of the various battery types. The ordinary carbon-zinc battery has very limited capacity at low temperatures, even as low as -10°C . Temperatures as high as 55°C will drastically shorten battery life. Alkaline and nickel-cadmium batteries can be used at temperatures as low as -40°C . Nickel-cadmium batteries are particularly useful, since they can be recharged with chargers that are widely available and batteries of that type are now made to fit the various sizes of carbon-zinc batteries in wide use.*



Figure 7-4. Type 1987 Sound Level Calibrator installed on a sound level meter.

7.5 CALIBRATORS.

Much is to be gained from the use of an accurately calibrated acoustical- or vibration-measurement system. When an accurate calibration is made, the consistency of comparison measurements can be improved, a closer approach to an allowed performance specification is possible, and careful attention to measurement techniques will be repaid by more accurate measurements.

Sound-Level Calibrators. An absolute sensitivity check with an acoustical signal as the source is the primary test made by conventional sound-level calibrators.

The 1987 Minical Sound Level Calibrator supplies a 1000-Hz acoustical signal at two levels, 94 dB and 114 dB. It works with both the $\frac{1}{2}$ -inch and 1-inch

*The Radio Shack 9-V NiCad rechargeable battery (Radio Shack Part No. 23-126) has been found particularly useful for the GR 1954 Noise Dosimeter where it will provide 16 hours of operation between charges, and the charger (Part No. 23-131) will recharge the battery overnight.

microphones. The 94-dB level makes it possible to check the operation at a level that is near that of many critical measurements. Another simple calibrator is a pistonphone available from other manufacturers.

A comprehensive check of the performance of a sound-measuring instrument or system is possible with the 1986 Omnical Sound-Level Calibrator, shown in Figure 7-5. One can test the absolute sensitivity at frequencies of 125, 250, 500, 1000, 2000, and 4000 Hz, at levels of 74, 84, 94, 104, and 114 dB. This wide choice permits one to check the absolute level near the level of the sound being measured and over the important frequency range of the sound. Or one can check the performance of a wide-range meter at different levels, the behavior of the level range control, or the response of the system, which may include weighting networks or filters, at a series of frequencies.



Figure 7-5. 1986 Omnical Sound-Level Calibrator.

The 1986 also provides 200 and 500 millisecond tone-bursts for testing the detector averaging characteristics, and a tone burst sequence for testing the accuracy of the squaring circuit (GenRad AN-104).

7.6 AUDIOMETER CALIBRATORS.

Audiometry is one of the fields of measurement where it is particularly important to have equipment in proper operating condition and well calibrated. Comprehensive calibrations should be done at least every 6 months, by the manufacturer or at some other laboratory qualified to certify such calibrations. In addition, a daily monitoring check on the audiometer and earphones can be done quickly and easily with the 1562-Z Audiometer Calibration Set or the 1933 Audiometer Calibration System. If the audiometer is not used daily, the monitoring check can be done before use of the audiometer.

The basic instrument in the 1562-Z is the 1565-B sound-level meter, which, of course, is essential to a hearing-conservation program for checking noise levels in the plant. It is coupled to the earphone of the audiometer by an earphone coupler, which is included (Gross, 1966, 1967, 1968). The sound level produced in

the audiometer earphones can then be checked by the sound-level meter in accordance with the expected level as given in the instructions. For an independent check on level a 1562 Sound-Level Calibrator is also part of the set.

7.7 VIBRATION PICKUP SYSTEM WITH THE SOUND-LEVEL METER.

Vibration measurements can be made with a sound-level meter when a vibration pickup is substituted for the microphone. When the GR 1933-9610 Vibration Integration System is used with either the 1933 or 1982 Precision Sound-Level Meters and Analyzer absolute measurements of acceleration, velocity and displacement are readily possible over a wide frequency range. The system includes an accelerometer with a magnetic clamp and a vibration integrator. The 1933 and 1982 give readings directly in dB re the standard references for acceleration, velocity, and displacement. A special slide rule is provided to permit easy conversion to ordinary vibration units.

7.8 VIBRATION CALIBRATOR.

The vibration calibrator, shown in Figure 7-6, is a small, single-frequency calibrator useful for checking the over-all operation of a vibration-measuring system (Gross, 1960). The calibrator consists of a resiliently supported cylindrical mass, driven by a small, transistorized, electromechanical oscillator mounted within the cylinder. Small accelerometers may be mounted on either of two disk-shaped platforms attached to the shaker. Large accelerometers may be mounted in place of the disk-shaped platforms. To calibrate an accelerometer, the level control is adjusted for a meter reading corresponding to the mass added to the moving system of the calibrator. The accelerometer is then being driven at an acceleration of 1 g at 100 Hz. The excursion of the calibration can be adjusted for 1-g acceleration with any pickup weighing up to 300 grams.



Figure 7-6. 1557 Vibration Calibrator for overall calibration of a vibration measuring system at 1 g at 100 Hz.

REFERENCES

Standards

ANSI S1.4-1971 Sound Level Meters

IEC 651 (1979) Sound Level Meters

Other

E.E. Gross, Jr. (1960), "Little Dithers," *General Radio Experimenter*, Vol 34, #11/12, Nov/Dec, pp 3-5.

E.E. Gross, Jr. (1966), "A Standard Earphone Coupler for Field Calibration of Audiometers," *General Radio Experimenter*, Vol 40, #10, Oct, pp 15-20.

E.E. Gross, Jr. (1967), "Field Calibration of Audiometers," *General Radio Noise Measurement*, Vol 1, #1, March pp 3-5.

E.E. Gross, Jr. (1968), "New Audiometer Calibration Set," *General Radio Experimenter*, Vol 42, #4, April, pp. 20-22.

W.R. Kundert (1977), "Sound Level Meters: The State of the Art," *Noise Control Engineering*, Vol 9, #3, Nov-Dec 1977, pp 120-130.

W.R. Kundert (1974), "The Impulse Sound-Level Meter — What's It All About," *Sound and Vibration*, Vol 8, #3, March 1974, pp 50-53.

H. Niese (1965), "Eine Methode zur Bestimmung der Lautstarke Beliebiger Gerausche," *Acustica*, Vol 15, #2, pp 117-126.

GenRad Application Note AN-104, "1986 Omnicall Sound-Level Calibrator: A System for field calibration of sound-measuring instruments," GenRad, Concord, Mass.

Chapter 8

Analysis

8.1 INTRODUCTION

Electronic techniques can provide more information about sound or vibration signals than merely the over-all levels. We can find out how the energy of a signal is distributed over the range of frequencies of interest, a process that we can describe as analysis in the frequency domain. We can find relations among signals as a function of time by correlation techniques, and we can enhance the appearance of coherent elements in a signal, if a synchronizing trigger is available, by waveform averaging. These two we can class as analysis in the time domain. We can find the amplitude distribution of a signal, which shows how often the signal is at any of a possible range of values, and this process we class as analysis in the amplitude domain.

We shall first discuss analysis in the *frequency domain* in general terms. This type of analysis, which has been called "frequency analysis," "wave analysis," "spectrum analysis," "time-series analysis," and "harmonic analysis," has been widely used for noise measurements. It is invaluable in guiding one to reduce noise and vibration efficiently (see Figure 8-1). It is also helpful for preventive maintenance. As we have seen in an earlier chapter, it is used in a number of procedures for estimating the probable effects of noise and vibration on man.

The development of electronic digital techniques has made instruments for analysis in the time domain and amplitude domain practical. One aspect of digital techniques, called "sampling," will be described, because it is helpful in understanding the concepts of autocorrelation, crosscorrelation, waveform averaging, and amplitude distribution. After those and some additional processes have been described, the implementation of various forms of analysis and their characteristics will be discussed.

The application of some of these techniques is not so obvious from the earlier discussion as is spectrum analysis, and some references will be given to their use as they are discussed.

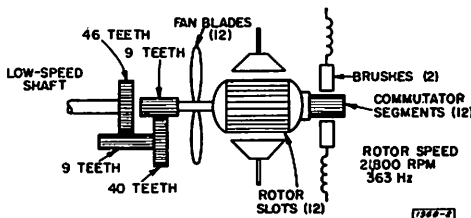

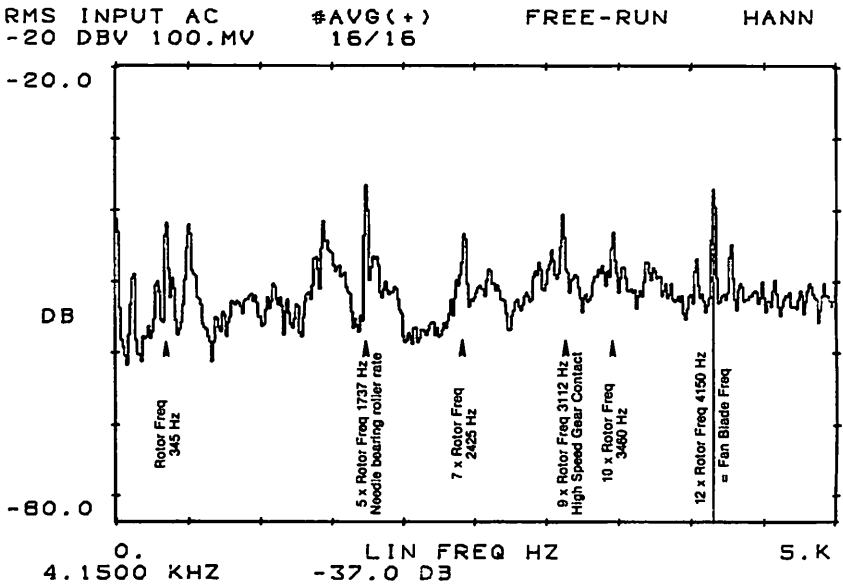
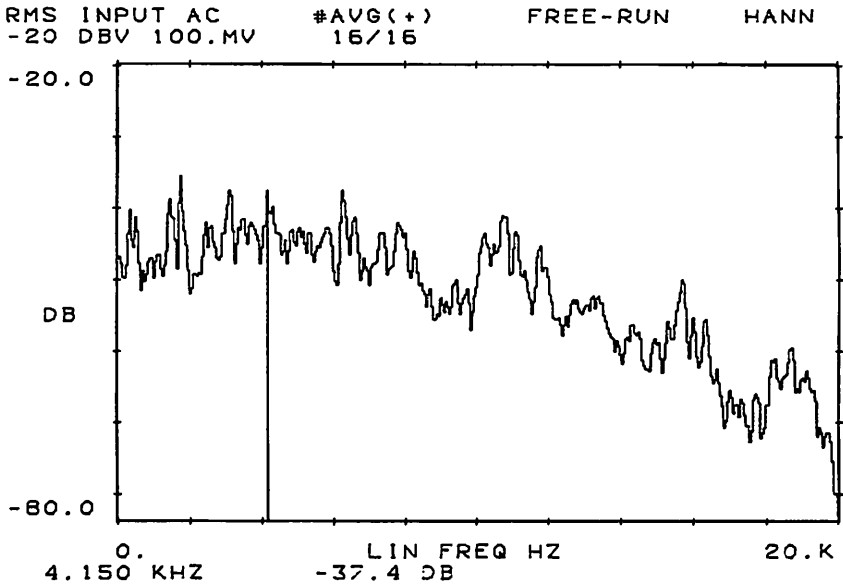

Figure 8-1. Chart records of the sound spectrum of a motor and gear-train assembly (see sketch). Both records were taken on a Type 2512 Spectrum Analyzer. The 20-kHz range shows the full audible spectrum with significant components extending out to beyond 10 kHz. The 5-kHz range shows more detail for the region of greatest concern for quieting. Most of the important components are simple multiples of the high-speed rotor frequency.

8.2 ANALYSIS IN FREQUENCY BANDS.

To make an analysis in the frequency domain, the signal energy is electronically separated into various frequency bands, for example, octave bands, each of which covers a 2-to-1 range of frequencies. The analysis yields a series of levels, one for each band, called "band levels," or for octave bands, "octave-band levels" or "octave-band sound-pressure levels." Here it is apparent that the band in which a reading of level is obtained must be specified if the information is to be of value.

8.2.1 Octave Bands. The preferred series of octave bands for acoustic measurements covers the audible range in ten bands. The center frequencies of these bands are 31.5, 63, 125, 250, 500, 1000, 2000, 4000, 8000, and 16,000 Hz. The actual nominal frequency range of any one of these bands is 2-to-1; for example, the effective band for the 1000-Hz octave band extends from 707 to 1414 Hz.

Another series of octave bands was used before 1966. The older bands were a 75-Hz low-pass unit, and the octave bands of 75 to 150, 150 to 300, 300 to 600, 600 to 1200, 1200 to 2400, 2400 to 4800, and 4800 to 9600 Hz, but these are no longer preferred, according to American National Standards. This older series is still specified in a number of test codes, however, and the published data obtained with this series is extensive.*

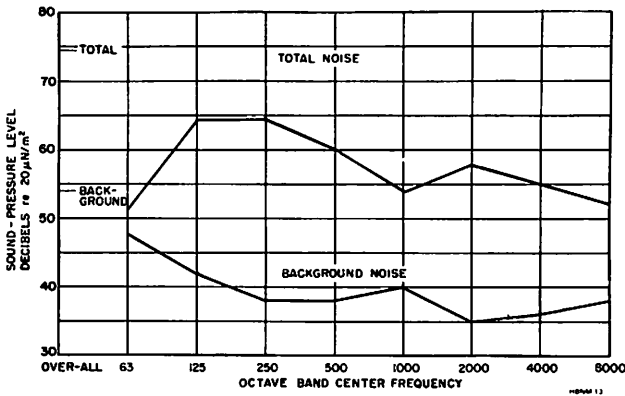

Figure 8-2. A plot of the octave-band analysis of noise from an office machine. (Graphic paper for plotting octave band levels is available from Codex Book Co., Inc., Norwood, Mass., as Form 31464 for the preferred octaves.)

When a graph is made of the results of octave-band pressure level measurements, the frequency scale is commonly divided into equal intervals, between the position designated for each band and the position for the band adjacent to it in frequency. The pressure level in each band is plotted as a point on each of these positions along the other axis. Adjacent points are then connected by straight lines. An example of a plot of this type is given in Figure 8-2. An alternative presentation uses horizontal lines centered on the band at the measured level.

8.2.2 One-Third-Octave Bands. For more detailed analysis of the distribution of sound energy as a function of frequency, still narrower bands are used. The next popular division is a split of the octave into three parts. This choice is based partly on the fact that ten such filters can be arranged effectively to cover a 10-to-1 frequency range. The preferred center frequencies for such a series would

*A method for converting octave-band levels measured with this older series to levels for the new series is given in Appendix A of ANSI S1.11-1966, American National Standard Specification for Octave, Half-Octave, and Third-Octave Band Filter Sets.

be, for example, 100, 125, 160, 200, 250, 315, 400, 500, 630, and 800 Hz.* The next 10-to-1 set would start with 1000 Hz as the center frequency and continue by multiplying each number by 10, 100 and so on (1000, 1250, 1600, 2000 ...). Similarly, lower preferred frequencies are obtained by a division of 10, 100, etc. For practical reasons the usual span of third octaves for acoustic noise analysis runs from 25 to 10,000 Hz.

The actual effective band for a one-third-octave filter at 1000 Hz extends from about 891 to 1122 Hz. That is, the bandwidth is about 23% of the center frequency.

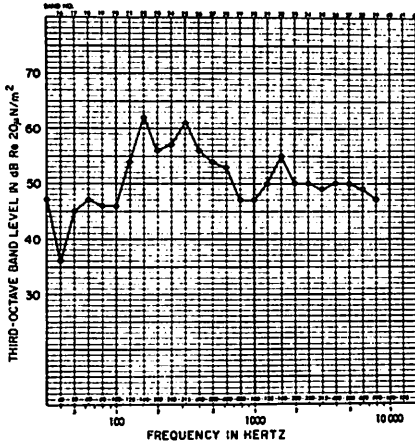

Figure 8-3. Plot of one-third-octave analysis of noise from office machine. (Codex Book Co., Form 31462.)

Third-octaves vs. octaves. When we wish to compare a one-third-octave analysis and an octave analysis, it is best to combine the one third octaves, in groups of three to get equivalent octaves. Thus, for example, to find the equivalent 1000-Hz octave-band level, combine the third-octave levels at 800 Hz, 1000 Hz, and 1250 Hz. Suppose the levels are 74.5, 73.0 and 71.0 dB. These levels can be converted to relative power, summed, and then translated back to level. Or we can use the chart of Figure 2-4 to combine them. The combination of 74.5 and 73.0 is $74.5 + 2.3 = 76.8$. This result combined with 71.0 is $76.8 + 1.0 = 77.8$ dB.

8.2.3 Band numbers. The bands used in analysis of sounds are also numbered. The one centered at 1 Hz is number 0, and the one-third-octave band numbers go up by one in successive bands. Thus the band centered at 1000 Hz is #30. The octave bands use the same numbers, and thus successive octave-band numbers differ by 3.

In general the band number, N, is determined by the formula

$$N = 10 \log_{10} f/f_0$$

where f is the center frequency of the band in Hz and f_0 is 1 Hz.

8.2.4 Narrower Bands. Analyzers that use third-octave and octave bandwidths are widely used in acoustics, but still narrower bands are essential for some purposes. One-tenth-octave (6.9%), one-twelfth-octave (5.8%), one fifteenth-octave

*These center frequencies are nominal values, rounded for convenient reference. The actual values are based on the formula $f = 10^{n/10}$, where n takes on integer values. The actual series starting at 100 ($n = 20$) is then more precisely 100, 125.9, 158.5, 199.5, 251.2, 316.2, 398.1, 501.2, 631.0, 794.3, 1000, ...

(4.6%), and one-thirtieth-octave (2.3%), as well as a 1% bandwidth, have been used.

Some systems provide an analysis that effectively divides the spectrum into hundreds or thousands of bands that are a constant number of hertz (e.g. 1-Hz or 10-Hz) wide. These bands are obtained either by resonant filtering, after frequency translation by a technique known as heterodyning, by a correlation technique known as a Fourier transform, or by some combination of techniques. These techniques will be described later.

None of these narrower-band systems is standardized, but they are often essential for use in tracking down sources of noise and vibration and in preventive maintenance.

8.2.5 Spectrum Level (Spectrum Density). The spectrum level of a noise is the level that would be measured if an analyzer had an ideal response characteristic with a bandwidth of 1 Hz. The main uses of this concept are comparing data taken with analyzers of different bandwidths and checking compliance with specifications given in terms of spectrum level. Charts for converting this spectrum level from the band levels obtained with octave- and third-octave-band analyzers are given in the accompanying table and in Figure 8-4.

The corrections for spectrum level for a constant-bandwidth analyzer are independent of the center frequency to which it is tuned but do depend on the bandwidth used. As an example, for a 3-Hz band subtract 4.8 dB (10 Hz, subtract 10 dB, 50-Hz, subtract 17 dB) to obtain the spectrum level.

The conversion to spectrum level has meaning only if the spectrum of the noise is continuous within the measured band and if the noise does not contain prominent pure-tone components. For this reason the results of the conversion should be interpreted with great care to avoid drawing false conclusions.

The sloping characteristic given for the third-octave analyzer in Figure 5-4 results from the fact that the analyzer is a constant-percentage-bandwidth analyzer; that is, its bandwidth increases in direct proportion to the increase in the frequency to which the analyzer is tuned. For that reason a noise that is uniform in spectrum level over the frequency range will give higher-level readings for high frequencies than for lower frequencies, with this analyzer.

Table 8-1

CONVERSION FROM OCTAVE BAND TO SPECTRUM LEVELS

| Band Center | Decibels* |
|-------------|-----------|
| 31.5 | 13.5 |
| 63 | 16.5 |
| 125 | 19.5 |
| 250 | 22.5 |
| 500 | 25.5 |
| 1,000 | 28.5 |
| 2,000 | 31.5 |
| 4,000 | 34.5 |
| 8,000 | 37.5 |
| 16,000 | 40.5 |

*To be subtracted from octave-band level readings to obtain spectrum level.

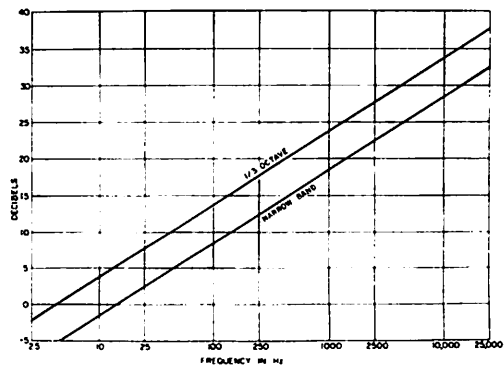

Figure 8-4. Plot showing number of decibels to be subtracted from Type 1564 readings to obtain spectrum level. The "Narrow Band" is about 7% wide. The "1/3-octave" is about 23% wide.

For 1/3-octave, $K = (i - 6.35)$ dB where $i = 1/3$ -octave band #
 K is to be subtracted from 1/3-octave level.

8.2.6 Components. The measured value in a band is sometimes called the value of a "component." This term is more commonly used for an analysis that divides the range of interest into a very large number of bands. The center frequency of a band is used to designate the particular component; thus, "the component at 120 Hz," "the 120-Hz component," or "the component whose frequency is 120 Hz." The term "component" is considered particularly appropriate if it is expected that the energy in a particular band is concentrated in a very narrow frequency region, as often occurs at frequencies that are multiples of the power-line frequency or of a rotational frequency of a motor. Then the resultant analysis may be described as showing "lines" at certain frequencies.

8.2.7 Conversion of Octave-Band to A-Weighted Levels. Because A-weighted sound levels are so widely used for noise ratings, some may wish to convert measured octave-band levels to the equivalent A-level when that sound level did not happen to be measured. This conversion is readily accomplished by means of Table 8-2, which is used as follows:

1. Add the correction numbers given in the table to each of the corresponding measured octave-band levels.
2. By means of the table in Appendix I convert these corrected numbers to relative power.
3. Add the relative powers of all the bands.
4. Convert back from power to level in dB.

Note that instead of steps 2, 3, and 4 the summing of the corrected levels can be done in pairs by the chart of Appendix II.

Table 8-2
CORRECTIONS FOR A-WEIGHTED OCTAVE-BAND ANALYSIS

| <i>Preferred Series of Octave Bands</i> | | | | <i>Older Series of Octave Bands</i> | | | |
|---|----------------|--------------------|-------|-------------------------------------|--|--------------------|-------|
| Band Center | | | | | | | |
| Band # | Frequency (Hz) | Original Weighting | | Octave Band (Hz) | | Original Weighting | |
| | | Flat | C | | | Flat | C |
| 15 | 31.5 | -39.4 | -36.4 | 18.75— 37.5 | | -43.4 | -39.3 |
| 18 | 63 | -26.2 | -25.4 | 37.5 — 75 | | -29.2 | -28.0 |
| 21 | 125 | -16.1 | -15.9 | 75 — 150 | | -18.3 | -18.0 |
| 24 | 250 | - 8.6 | - 8.6 | 150 — 300 | | -10.3 | -10.3 |
| 27 | 500 | - 3.2 | - 3.2 | 300 — 600 | | - 4.4 | - 4.4 |
| 30 | 1,000 | 0 | 0 | 600 —1,200 | | - 0.5 | - 0.5 |
| 33 | 2,000 | + 1.2 | + 1.4 | 1,200 —2,400 | | + 1.0 | + 1.1 |
| 36 | 4,000 | + 1.0 | + 1.8 | 2,400 —4,800 | | + 1.1 | + 1.7 |
| 39 | 8,000 | - 1.1 | + 1.9 | 4,800 —9,600 | | - 0.4 | + 1.9 |

Table 8-3
EXAMPLE OF CALCULATIONS*

| Octave Band Center (Hz) | Band Level (dB) | Correction for A-wtng. | Corrected Level (dB) | Relative Power/10 ⁶ |
|-------------------------|-----------------|------------------------|----------------------|--------------------------------|
| 31.5 | 78 | -39 | 39 | .01 |
| 63 | 76 | -26 | 50 | 1.1 |
| 125 | 78 | -16 | 62 | 1.6 |
| 250 | 82 | - 9 | 73 | 20.0 |
| 500 | 81 | - 3 | 78 | 63.1 |
| 1,000 | 80 | 0 | 80 | 100 |
| 2,000 | 80 | + 1 | 81 | 125.9 |
| 4,000 | 73 | + 1 | 74 | 25.1 |
| 8,000 | 65 | - 1 | 64 | 2.5 |
| | | | | 338.3† |

*For the factory noise used previously.
† 338×10^6 corresponds to 85.3 dB(A)

8.3 TIME SERIES AND SAMPLING.

8.3.1 Time Series. An acoustic signal that is monitored at a point in space can be considered as a variation in pressure as a function of time. This variation is a continuous function that we transform into a similar electrical function by the use of a microphone. We can operate on this electrical signal as a continuous function by electronic circuits, and we call this "using analog techniques."

It is also useful to convert the function into a series of discrete numerical values, which is called a "time series." We can then operate on these discrete values by digital techniques with a computer program. This computer may be one that is easily recognized as such, or it may be built into the system in such a way that its operation is not apparent externally.

◆ **8.3.2 Sampling.** The process of obtaining a series of discrete numerical values from a continuous function is known as sampling. We use electronic circuits to observe the instantaneous voltage of the signal at regular intervals. This instantaneous voltage is then converted into an electrical signal that represents a numerical value proportional to that voltage.

What requirements do we have to put on this time series so that it is an adequate representation of the original continuous function? The answer depends on what information we want from the time series. If we wish to be assured that we can perform a direct spectrum analysis on the time series, we can begin with a specification in the frequency domain. We can see that one factor is how frequently we sample, compared to how rapidly the signal changes. The actual rule is that the sampling rate must be at least twice the highest frequency component in the signal.

The frequency of the signal that corresponds to that minimum sampling rate has been called the "Nyquist frequency," which is then one-half the minimum sampling frequency. The corresponding maximum time between samples, which is the reciprocal of the minimum sampling frequency, is called the "Nyquist interval." As we shall see later we can sample less frequently for operations in the amplitude domain. Sampling less frequently has also been used to transfer information from a limited band at high frequencies to a low-frequency region, but then, care must be taken to ensure that overlapping of information does not confuse the process. The basic point here is that more frequent sampling than at the Nyquist interval is sufficient sampling, but it is not always necessary when we need only a limited amount of information from the signal.

◆ **8.3.3 Quantization.** When a sampled value is converted into an equivalent numerical value by an analog-to-digital converter, each value is represented by a finite number of on-or-off states of electronic elements. The converter has in effect an input-output relation that is a series of steps. The size of the steps depends on the total range to be covered and the number of steps available. Since the equivalent electrical signal is usually coded in binary form, the number of steps is then, say 256, 512, 1024, etc., which is 2 raised to some integer exponent.

The exponent of 2 used is called the number of "bits," and a 10-bit converter would have 1024 discrete values. Since the signal has both positive and negative values, this number may be cited as 512 values plus a sign bit.

Each of the sampled values is now rounded off or quantized to the nearest number of units in the range available. This quantization leads to an error that may be as much as one-half the quantum step or interval in the conversion. On the average, however, it will be less than that, and the equivalent noise con-

tributed by this error has an rms value of about 0.3 times the interval. Furthermore, this noise is distributed in frequency, and when an analysis is made, the equivalent noise level will be correspondingly lower in each band.

An example of small-signal operation is sometimes cited as a limiting feature of the analog-to-digital converter. Assume that the signal applied to the converter has a total voltage excursion that is less than one interval in its range. Then, the output will remain at a zero value, and the signal will not be recognized. This mode sets one limit on a type of dynamic range. But in practice such a situation should not ordinarily occur. The converter should be preceded by electronic amplifiers of sufficient gain so that any signal to be studied can be brought up to the level required for proper utilization of the converter. The dynamic range that is then of interest is the level of the smallest component that can be observed compared to the level of the total signal, which we shall discuss briefly.

In analysis one is often interested in each of a small number of small components of a signal, which may contain one or more dominating components. What happens to the small components when the signal is sampled? The answer is that they are preserved but, as described above, quantization noise appears (Sloane, 1968). Since this noise is distributed in frequency, when an analysis into many bands is made, the noise on the average in each band becomes very small. With a high-resolution processor, one can then observe components that need be only somewhat greater than the noise level in the band, which may be appreciably less than the total noise level.

The significant reductions in effective quantization noise that occur in some processing procedures mean that the computing system, used to process the digital data, can advantageously utilize a significantly higher resolution than is used in the analog-to-digital converter. It is for this reason that one can justify the use of a computer with 16-bit resolution for processing data from a 10-bit converter, for example (Korn, 1966, Chapter 6; Widrow, 1961).

◆ **8.3.4 Aliasing and Filtering.** In order to appreciate other effects of this sampling process, it is useful to look at the sampling of some sinusoidal pressure waveforms. "Waveform" is used here to describe the instantaneous amplitude as a function of time. In Figure 8-5 three waveforms are shown with sampled points (the crosses) uniformly spaced on the time axis. In the middle example shown, the period of the sampling is one-fifth that of the period of the wave; sampling frequency of 5000 Hz = 5X frequency of the wave (1000). One can see that it is not possible to pass a sinusoid through the points shown that has a lower frequency (longer period) than that shown in the middle.

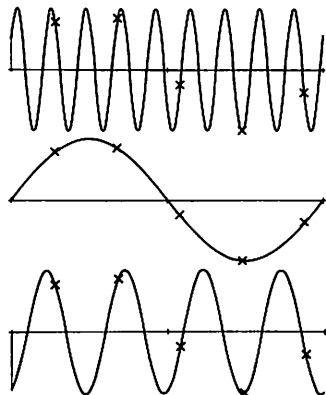

Figure 8-5. Waveforms of three frequencies sampled at the same rates for digital processing.

The lower waveform in the figure is shown sampled at a rate five-fourths the frequency of the wave, and the upper waveform sampling rate is five-ninths the frequency of the wave. As shown in the figure we can draw another lower-frequency wave through the sample points. If we call the frequency of the middle wave 1000 Hz, and the sampling frequency 5000 Hz, the other frequencies are 4000 Hz and 9000 Hz. We could have shown waves whose frequencies are 6000, 11000, 14000, 16000, 19000, 21000 Hz, etc., all of the same peak amplitude and all going through the same points. Since these cannot be distinguished from one another by the selected set of points, they are called aliases (Blackman and Tukey, 1958, p. 167; Bendat and Piersol, 1966, 278ff). The frequencies of components that are aliases are related by the equation $\pm f_1 = f_2 \pm kf_s$, where f_1 and f_2 are the alias frequencies, k is an integer, and f_s is the sampling frequency.

When these sampled points are treated by digital processing, they are usually assumed to be from a wave of the lowest frequency. If the sampling rate for an incoming signal is not greater than twice the highest frequency of any component in the signal, then some of the high-frequency components of the signal will be effectively translated down to be less than one-half the sampling rate. This translation may cause serious problems with interference of high and low-frequency components.

How are these interference effects avoided? Either we sample at a sufficiently high rate to avoid them, or we put in a low-pass filter to reduce the amplitudes of the higher-frequency components, so that they are no longer large enough to be troublesome.

In order to see what is required here, consider the filter-response characteristic, shown in Figure 8-6, which is for a low-pass filter with a nominal cutoff frequency at 5 kHz. This statement merely means that, in a signal applied to the input of the filter, components with frequencies above 5 kHz are attenuated compared to those components having frequencies below 5 kHz. Assume we are interested only in the range below 5 kHz. If we sampled at a 10-kHz rate, and a component at 5.1 kHz was present, it would be equivalent to one at 4.9 kHz and the filter would not adequately reject the component at 5.1 kHz. Our processing would lead us to believe there was a component at 4.9 kHz and we would be misled. Suppose we sampled at a 15-kHz rate as shown on the figure. The 5.1 kHz component would be there, but it is beyond the range of interest, and we would ignore it.

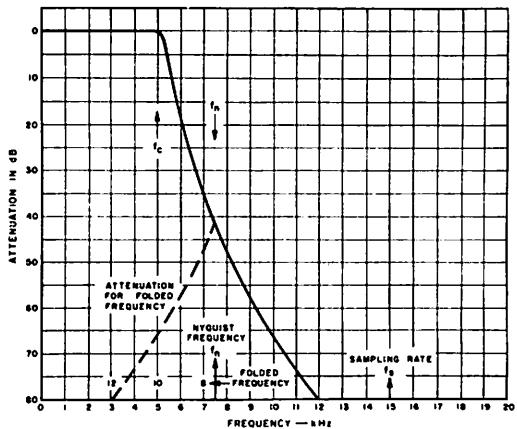

Figure 8-6. Low-pass filter characteristics required to reduce effects of aliasing.

If however, there is a component at 10 kHz, it would appear to be at 5 kHz in the processing, and we might be misled. But now the filter would attenuate this component by some 66 dB, which would probably make it so small that we would not be concerned about it. Any components at a frequency higher than 10 kHz would be attenuated even more and be correspondingly less important. The components originally at frequencies between 5 and 7.5 kHz would appear, but with some attenuation, and they would be ignored, because we assumed interest only up to 5 kHz. Components between 7.5 and 10 kHz would be translated into the range between 5 and 7.5 kHz and also be ignored.

It is sometimes easier to think of the component frequencies as being folded about a frequency equal to one-half the sampling rate. This folding is illustrated on the figure for the attenuation characteristic.

If we wanted to suppress the extraneous components at 10 kHz and beyond even more than 66 dB, we could either use a filter that had more attenuation at those frequencies or go to a higher sampling rate, or both.

In general, it is advantageous to use filters to limit the frequency range of the input data, since we can then use a lower sampling rate and a minimum number of points for a given sample time. These filters when used in this way are often called, "anti-aliasing filters" or, simply, "aliasing filters." If we have to process a signal that lasts for a second and that could have components up to 12,000 Hz, we would have to sample at more than a 24,000-Hz rate. We would then have more than 24,000 values to process. If we are interested only in the range below 1000 Hz, we could use a low-pass filter that starts attenuating at 1000 Hz. We could then sample at a 3000- to 4000-Hz rate, and we would save much time in processing.

◆ **8.3.5 Frame Size.** Some digital operations can be applied in a running fashion to the sampled values as they are produced. But other operations are done in batches, and it is convenient then to think of a set of points or values that are processed as a group, and we shall call such a set a "frame." The word "sample" is also used for such a set, but this usage may lead to confusion, since "sample" is thought by some to be an individual value. "Block" is also used for this set of points, but it is convenient to reserve this word as a more general term for sets of points.

The frame size, which is the number of sampled values in the frame, is most conveniently set up in powers of 2, that is, 64, 128, 256, etc., for many of the operations, but particularly for the calculation of the spectrum values by the fast Fourier transform.

8.4 ANALYSIS IN TIME DOMAIN.

8.4.1 Correlation. Correlation is a measure of the similarity of two time series or waveforms, and it is a function of the time displacement between the two (Lathi, 1965, Chapter 12; Anstey, 1966). If a waveform is compared with itself by the correlation process, it is called an autocorrelation. If the waveforms to be compared are distinct, the process is called cross-correlation.

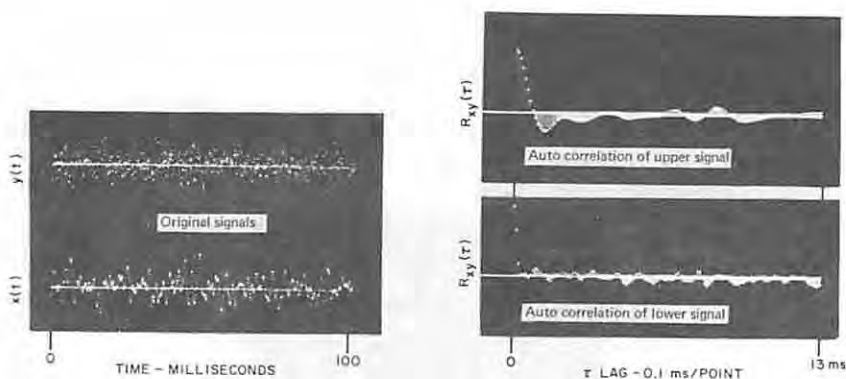

Figure 8-7. Auto correlation functions.

◆ **8.4.2 Autocorrelation.** To obtain the autocorrelation of a waveform or time series we calculate a whole set of averaged products. We multiply point-by-point that waveform with an identical one, and we take the average of these multiplied values, over the full range of the wave. If there is no time displacement, the result is the mean square value, and it is usually termed, power, although it may not be related to physical power. If the two waveforms are shifted in time with respect to each other, another averaged product can be obtained, and so on for many shifts in time. These averaged products as a function of the time displacement, or delay (usually designated by τ and also called "lag"), are the autocorrelation function.

The autocorrelation function is seen to be an extension of the concept of the mean-square value of a wave (more often used, after the square root has been taken, as the root-mean-square value). The autocorrelation function is symmetrical about the point of zero delay, and at zero delay it has the maximum value equal to the mean-square value (Figure 8-7).

If the waveform has a periodic component, the autocorrelation function will show a periodic character. This behavior is illustrated by the example shown in Figure 8-8, where a noisy signal contains a periodic component, which is not obvious in the original waveform, but the autocorrelation function shows it clearly (Lee, 1960; Heizman, 1970). Some of the important applications of autocorrelation are based on this property.

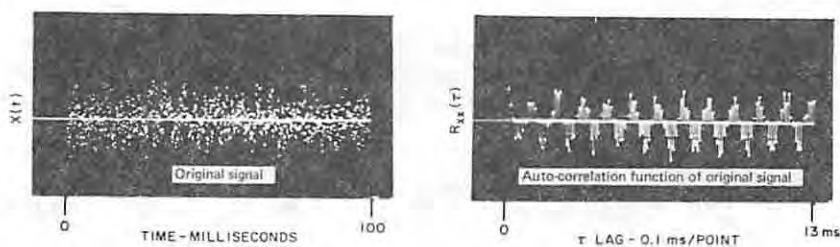

Figure 8-8. Auto correlation analysis of sinewave buried in noise.

◆ **8.4.3 Cross-correlation.** When the cross-correlation function is calculated, we have a measure of the similarity of the two waveforms used in the calculation. Now the maximum value does not always occur with zero delay, but the time at which the maximum value occurs may be significant. As shown in Figure 8-9 for the two waveforms there correlated, they are most similar when a delay of 0.7 millisecond is used. This time may be an important clue in tracking down the source of a disturbance.

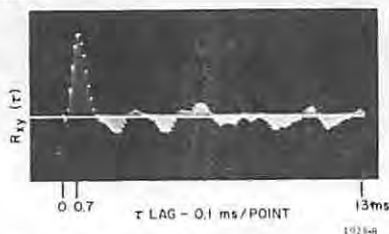

Figure 8-9. Cross correlation function of the original signals of Figure 8-7.

The waves shown are sampled waves. The original waves can be thought of as those shown, with successive points connected by a smooth continuous line.

Applications of Correlation Techniques. Correlation techniques have been applied to determine which among a number of sources is contributing most significantly to the noise at a given point (Goff, 1955); to locate noise sources by direction finding (Faran and Hills, 1952b, Gilbreck and Binder, 1958); to separate aerodynamic noise of turbulent boundary layers from noise radiated by jet engines (Bhat, 1971); to measure panel-transmission loss without requiring that flanking signals be eliminated (Goff, 1955; Burd, 1964; Imai, 1968; Burd, 1968); to reduce the contribution of wind noise to a measurement of noise from a device (Goff, 1955; Burd, 1964); to measure the transient response of rooms (Goff, 1955); to measure the diffuseness of sound in a room (Cook et al., 1955; Balachandran and Robinson, 1967/68), and to measure sound absorption (Goff, 1955; Burd, 1964). The measurements of transmission loss and sound absorption by correlation techniques are limited in frequency range by the size of the object and the bandwidth of the applied noise signal. They are also measurements by a particular path and not the averaged random-incidence measurements of the standard methods. They are, therefore, more suited for research studies, for tests of materials in place or for tracking down difficulties rather than for rating procedures.

The application of correlation to signal detection in underwater echo ranging and signal transmission has been extensively investigated (Faran and Hills, 1952a; D. Middleton, 1960; Horton, 1969; Tolstoy and Clay, 1966; and many papers in the *J Acoust Soc Am*).

Correlation has been used to study the vibrations on the two sides of a panel in sound-transmission research (Nakamura and Koyasu, 1968), to study the flow of energy in structures (White, 1969), and to analyze seismic vibrations in geophysical exploration (Anstey, 1966).

◆ **8.4.4 Convolution and Superposition.** A digital operation called "convolution" is sometimes used in the time domain (Lathi, 1965, Chapter 10; Lee, 1960). If one waveform is convolved with another, one of them is reversed in time or folded back. Corresponding ordinates are multiplied and the products added. A whole series of these sums are obtained for different positions of the two waves,

and one has a result or output that is a function of the time displacement of the two waves. Except for the reversal in time, the operation is the same as cross-correlation.

If one of the waveforms is the input signal, the convolution can be used to produce a running average or smoothing of the wave or it can do a differencing operation, depending on the second function used in the convolution.

The operation can also be looked upon as a filtering of the input waveform. In this process the second function is known as the impulse response of the filter. It corresponds to the waveform that results when the filter is stimulated by an idealized impulse of finite energy but zero duration. The filtered output waveform is thus obtained by a convolution of the input waveform with the impulse response of the filter. The relations among the corresponding filter operations in the time domain and the frequency domain are shown in Figure 8-10.

Convolution in this type of operation is also superposition, which is more readily understood. If an input wave is assumed to be a collection of impulses occurring at successive instants of time, we can obtain the output wave by superposition of the individual responses to the impulses.

Each impulse response normally decays as time goes on. Thus, at any one instant the contribution to the output of preceding elements in the input wave is reduced, the farther back in time that we go. The output at any instant is a weighted sum of the past input. The impulse response is the weighting function.

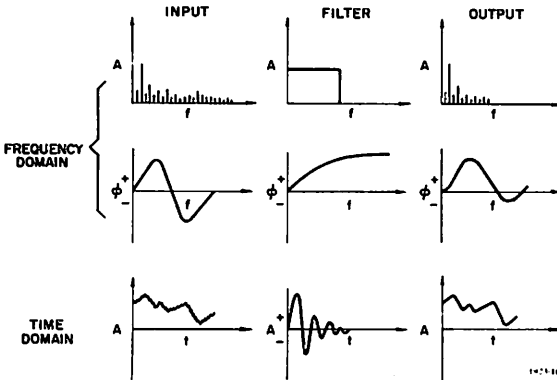

Figure 8-10. Graphical representation of interrelations between time and frequency functions.

◆ **8.4.5 Waveform Averaging. Summation Analysis.** In the study of noisy signals that include periodic components or that are responses to stimuli, the periodic component of the wave, or the evoked response, can be emphasized with respect to random noise or stray signals by a process known as waveform averaging (Geisler and Rosenblith, 1962; Clark et al., 1961; Nelson and Lassman, 1968; Rothman, 1970). It is essential in this process that a reference or triggering signal be available.

This process is a simple summing of corresponding ordinates of selected samples of the wave. Because of this summing, waveform averaging is also called summation analysis. Often it is left as a sum, but a division by the number of selected samples is necessary to convert to an average. If we state the operation in sampled terms, it might go like this: We select and store a frame of data as deter-

mined by the reference or trigger signal. When the trigger initiates the sampling of another frame, the first of the sampled values of the new frame is added to the first sampled value of the original frame. The second sampled value of the new frame is added to the second sampled value of the original frame, and so on. When the third frame is initiated the process is repeated.

If the trigger is synchronized to start a frame at the same point in the period of a repetitive wave, the elements in that wave of that period will sum directly. Noise signals will sum in a random fashion, and the net result is that the ratio of the desired signal to the noise will grow by a factor of the square root of the number of frames summed.

The summing at a periodic rate may be used in vibration studies to emphasize those elements in a vibration waveform that are synchronous with a shaft rotation, for example. It has been used to study the development of small surface defects in bearings (Hannavy, 1967), by summing at a period that corresponds to that of the particular part being studied. A similar procedure has been used to study gear defects (Thompson and Weichbrodt, 1969).

The signal does not have to be periodic if a trigger signal is available that precedes the desired signal by a fixed time. Thus, if a "click" stimulus is used to evoke a brain wave response, there is a reasonably stable delay between the onset of the click and the response. The click signal can be used to trigger the averaging, and the evoked stimulus can be enhanced, or pulled out of the noise, by adding many triggered frames of the response. Because there is some variability in the delay in biological systems, however, only some 10 to 100 frames can be used before the process is no longer helpful. In physical systems, the number of frames that may be useful can be many thousands.

Other methods of averaging are sometimes used. If the data are changing slowly, the averaging may be set up to make earlier data less important in the result than the latest data.

8.5 ANALYSIS IN AMPLITUDE DOMAIN.

◆ **8.5.1 Amplitude Distribution.** Suppose we are observing a noise whose maximum instantaneous sound pressure is 1 Pa. We set up a series of timers that record a running total of the times that the instantaneous value is within certain intervals. One of these is for the interval 0 to 0.1 Pa, and successive ones go in

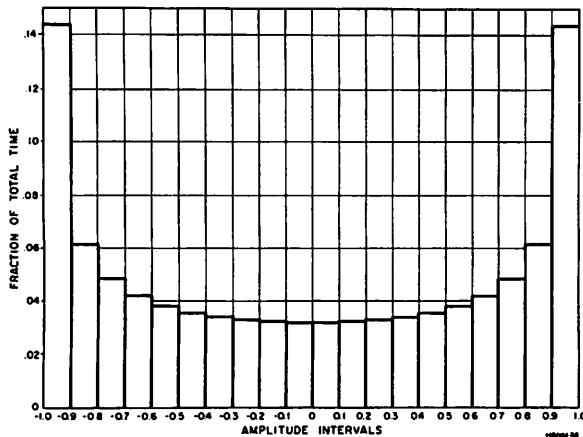

Figure 8-11.
Histogram amplitude
analysis of a sinewave.

0.1 steps in the series: 0.1 to 0.2, 0.2 to 0.3, . . . 0.9 to 1.0 and > 1.0 . A similar series is used for the negative values of sound pressure (note that sound pressure is the change in pressure with respect to the ambient average atmospheric pressure).

After these timers have been running for a while, we record the running total for each. We divide each value by the total time for all intervals and plot the results. Suppose we get the plot shown in Figure 8-11. This type of plot is often called a "histogram" or a "frequency distribution" (here "frequency" is used in the sense of "frequency of occurrence" and not "frequency in Hz").

Someone familiar with these plots would guess from Figure 8-11 that the sound-pressure wave that was observed was probably essentially sinusoidal in form. (Actually one cannot be definite about such an observation, since an infinite variety of waveforms could produce the same distribution.) If we refined the interval resolution to the limit, we could obtain the characteristic curve of Figure 8-12 for a sinewave. This plot is an amplitude-density distribution. The area under the wave between any two values is the fraction of the total time that the instantaneous pressure has a value that falls within that interval.

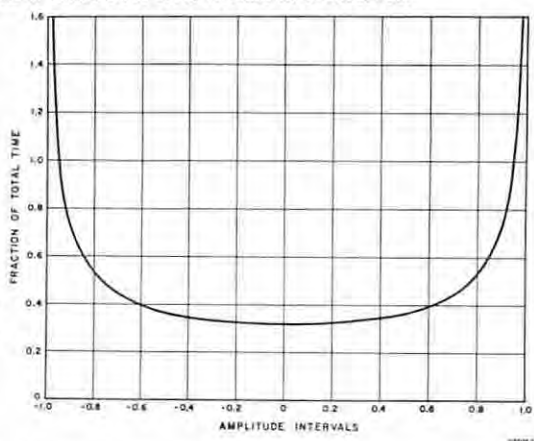

Figure 8-12. Amplitude density distribution of a finely sampled sinewave.

If we measured the amplitude-density distribution for a random noise we might get one of the form shown in Figure 8-13. If we did, we would assume we were dealing with a "Gaussian" noise, which is characterized by the bell-shaped curve. It is also said to have a "normal" distribution. An amplitude-density distribution of this form is commonly observed for acoustic noises.

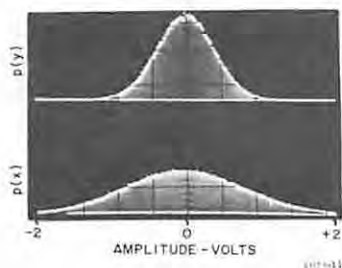

Figure 8-13. Amplitude histograms of random noise.

If a strong sinusoidal component is mixed with random noise, the amplitude-density distribution will be a mixture of the two basic density distributions shown.

If we have an amplitude-density distribution, we can calculate certain values that characterize it. For acoustical waves, the mean or average value over a long

period is zero. The mean-square value could be obtained by squaring each of the amplitude values, multiplying it by the proportion of the time that it is present, summing these products, and dividing by the total time. This mean-square value is termed the “variance” of the distribution. The square root of this variance is the “standard deviation,” usually called “sigma” (σ), and it is also the rms (root-mean-square) amplitude, provided the average is zero, and it is commonly used as a proper measure of the amplitude.

We could calculate other measures of the distribution, but the rms value is the most useful. Most modern acoustic metering systems are designed to indicate this rms value of the signal.

If we measure the amplitude-density distribution again at a later time, we will get a new set of values. We can keep doing this for a number of times and then we can compare the values we get. If they are all essentially alike, we call the noise “stationary,” that is, its amplitude-density distribution does not vary significantly with time, at least, say, for the range of times that we are interested in. It is also necessary that the spectrum remains essentially the same for true stationarity.

We have used the terms “essentially” and “significantly” to indicate that absolute equality is not expected for random signals. The meaning of the terms will be described in a statistical sense later, in the discussion of confidence limits and degrees of freedom.

The most important measure of the amplitude distribution of a random signal is the rms value or the standard deviation, and the density plot (Figure 8-14) is given in terms of the rms value. The accumulative value, or amplitude-distribution function, for Gaussian random noise is shown in Figure 8-15.

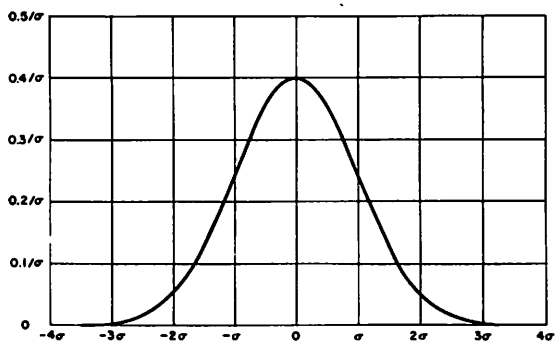

Figure 8-14. The amplitude density distribution $p(v)$ of Gaussian random noise.

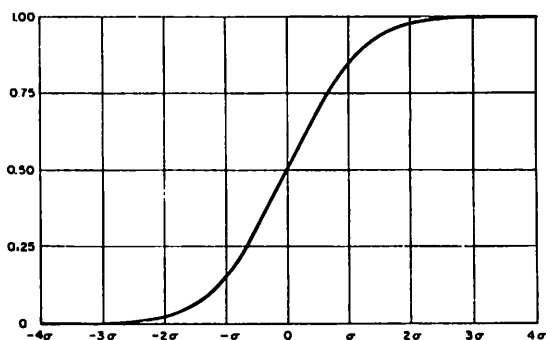

Figure 8-15. The amplitude distribution function $P(v)$ of Gaussian random noise.

The amplitude-density distribution is also the probability-density distribution and we can think of it in the following way. Suppose we have a Gaussian noise signal that is stationary. We take one measurement of the instantaneous sound pressure. If we disregard the sign, what is the probability that it will be less than the rms value? For a Gaussian noise this probability is about 68%, which is the area of the amplitude-density distribution curve between the "one-sigma" values (on both sides of the zero level). What is the probability that it will be more than 3 times the rms value? It is about 0.26%.

It is now easy to see that we could have approached this Gaussian characteristic in another way. Suppose we take a whole series of observations of the instantaneous value of a random noise, that is, we sample it. We can now plot a histogram of this set of values. We would expect that the histogram would be similar in shape to the characteristic "bell" or "normal" curve. As we increase the number of observations of the Gaussian noise, the histogram approaches the Gaussian shape more closely.

We can obviously calculate an rms value for the sample. If we do not sample too rapidly in comparison with the time characteristics of the noise, we find that with a set of 100 or more observations we can get a good estimate of the rms value of the noise signal. Note that for this signal we do not require that the sampling be done rapidly, as long as the signal is stationary. In fact the sampling can be done leisurely and not at the Nyquist interval. An interesting laboratory experiment can be based on sampling random noise essentially by hand and, therefore, at a slow rate.

If the signal being sampled is a periodic signal, even fewer observations of the signal are required for a good estimate of the rms value. But some unusual sampling situations must be avoided. Thus, the sampling rate must not have the same period as the period of the signal or some integer multiple of that period. When sampling procedures are used in the process of determining the rms value of a wave that may be periodic, these conditions are avoided by one of the following:

1. Sampling at a random rate.
2. Sampling at a rate that changes according to some rule.
3. Sampling with a period less than half the period of the signal.

The measurement of amplitude distribution, in a practical case, is not nearly so useful as a spectrum measurement and it is rarely done (Piersol, 1967). It is helpful, however, to explain it to bring in various ideas and techniques that are used in other applications.

8.5.2 Level Distribution. If the spectrum and the amplitude distribution of a noise remains essentially the same regardless of the time when a set of observations is made, it is stationary. But, actually, we are ordinarily concerned only with a limited time span. If we ignore the startup and shutdown phase of the cycle, the noise of most refrigerators can be regarded as stationary. We can make many measurements while it is running, we can run it again and again, and we can make more measurements that will give consistent results if we duplicate conditions.

Many other noises are not so readily made effectively stationary. Thunder, a sonic boom, a door slam, and an explosion are examples of transient sounds that have to be treated differently. But there are also noises of intermediate types or combinations of noises.

When a machine operator in a shop is setting up his work, the noise from his machine may be at a low level, but there will be some background noise from

other machines that are in operation. When he runs his machine, the noise in his vicinity may increase significantly. If we are trying to evaluate the noise he is exposed to, we need to take this variability into account. We can proceed in a fashion similar to that for amplitude distribution to obtain a "level distribution."

We use a sound-level meter to measure the level. (Now it is not the instantaneous value of the wave, but it is the rms value averaged over some time.) We use intervals of level, say 90-92 dB, 92-95 dB, 95-97 dB, etc., with times arranged to indicate the total time that the noise stays within each of the intervals. At the end of the day we could plot a histogram of the result, and we would have a level distribution of his exposure to noise. Such procedures are described more fully in paragraphs 4.12-4.14 and Chapter 14.

8.6 TECHNIQUES AND CHARACTERISTICS OF ANALYSIS.

The basic processes used for spectrum analysis are a filtering, or resonance, technique and a Fourier transform, or correlation, technique. Frequency shifting, or heterodyning, is sometimes used to extend the basic range of these systems, and time compression or scaling is used in some instruments to speed up the filtering process.

As indicated in the earlier sections, the signal can be processed by analog techniques, digitally, or by a combination of the two.

♦ **8.6.1 Direct Filtering.** Many analyzers now use sets of electronic band-pass filters to separate the signal components into the required number of standard bands. When those filters are operating directly at the frequencies of the desired bands, we call the analysis "direct filtering."

Most octave and one-third-octave analyzers use such electronic systems, either combinations of inductors and capacitors, or networks involving resistors, capacitors and amplifiers in feedback circuits, to produce the required resonant effects.

Serial or Parallel Operation. We can classify analyzers by another feature into two types, that is, serial or parallel. In strictly parallel operation, the input signal is passed simultaneously through a set of filters with detectors at the output of each filter (see Figure 8-16). The output level is then available continuously for each filter band.

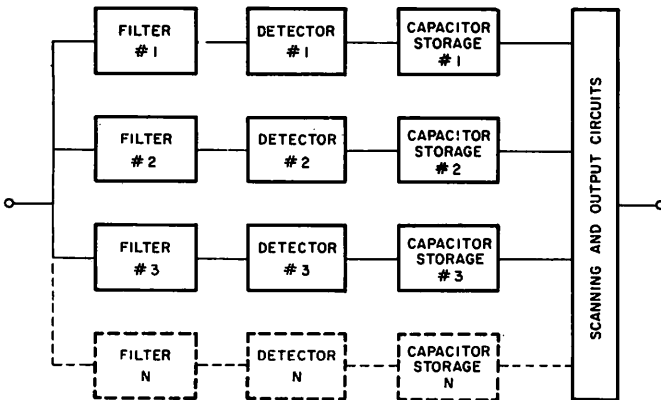

Figure 8-16. Typical parallel-operation analyzer.

In serial operation, however, only one detector is used, and the filters are sequentially switched into the circuit or are tuned sequentially to the required frequencies. The level in each band is determined before the next band is measured.

The tuning of the filter in serial operation may be continuous through the frequency range or it may proceed in steps. In acoustics, the stepped operation that goes from one standardized preferred center frequency to the next is more widely used than the continuous one, mainly because the spectrum is then characterized by a finite set of numbers.

Serial-type analyzers are usually smaller and less expensive than corresponding parallel types, because they require fewer elements to do the job. The parallel type, on the other hand, can be much faster. Consider the following example. If we dwell for one second to determine the level in each of 30 third-octave bands, the serial analyzer would require 30 seconds, while the parallel analyzer would have the output available after only one second. Some time must be allowed for presenting the data in usable form, but it is obvious that if many spectra with many bands must be measured, much time can be saved by the use of a parallel analyzer.

Digital Filtering. Band-pass filtering can be done digitally on a sampled time series (Gold and Rader, 1969; Oppenheim, 1969; Kuo and Kaiser, 1966; Enochson and Otnes, 1968). An output time series is generated from the input time series by the use of a difference equation, which relates an output value at a particular time to the input values at that time and for some previous times, as well as to one or more previous output values.

By the use of a group of these difference equations, we can simulate a set of one-third-octave filters, for example, that each produce a time series equivalent to a filtered signal. From each of the output time series we can calculate in the computer an rms value to give the one-third-octave levels.

Some of the parameters that affect the dynamic range, the discrimination against interfering signals, and the stability of the output time series are:

1. Accuracy and resolution of conversion to digital form.
2. Length of time series.
3. Actual difference equations used.
4. Accuracy of calculations.

8.6.2 Fast Fourier Transform. Another important spectrum-analysis technique is the basic one of direct application of the Fourier transform. It has only recently become significant in the analysis of actual acoustic and vibration signals as a result of the development of the calculation procedure called the Fast Fourier Transform (FFT) (Bingham et al., 1967; Singleton, 1969; Gold and Rader, 1969). FFT is an efficient way of calculating correlation of a waveform with sinewaves whose frequencies are integer multiples of the frequency corresponding to the time duration of the wave.

In order to apply the FFT to a signal, the signal is transformed into a digital time series as explained previously. A fixed number of consecutive points in the series is selected. Usually, this number is a power of 2, for example, 1024, or 2048. This time series is then transformed into corresponding components in the frequency domain by the use of the FFT calculation in a computer. If the signal is noise, or has the character of noise, a number of transforms must be combined to get statistical stability in the answer.

Some of the parameters that affect the characteristics of the process are the following:

1. Number of samples in selected time period.
2. Accuracy and resolution of the conversion to digital form.
3. Weighting functions used on the sampled values.
4. Number of transforms combined.
5. Accuracy of the calculation procedure.

These parameters determine the frequency resolution, the dynamic range, the discrimination against interfering signals, and the statistical stability of the output spectrum.

The number of output values developed in the analysis is equal to the number of data points in the original frame. But they are in pairs with a real (cosine) value and an imaginary (sine) value for each integer multiple of the fundamental frequency. The two together are then usually described as a frequency component with a real and imaginary part or as a vector with an absolute magnitude and a phase angle. For many acoustical problems, the phase angle is ignored and the magnitude at each integer multiple of the fundamental frequency is the value used as the result of the analysis.

The square of this magnitude is sometimes called an "autospectral value," and the set of squares is the "autospectrum." This set of squared values is also sometimes called the "power spectrum." Since the actual values are hardly ever "power," and since the "cross spectrum" is also used (see paragraph 5.7.1), it is convenient to use the terms "autospectrum" and "cross spectrum" with the similar and related "autocorrelation" and "cross-correlation."

Some simple relations for the frequency transform are as follows:

Number of component lines = $\frac{1}{2}$ number of data points in frame.

Frequency range = $\frac{1}{2}$ sample rate.

$$\text{Resolution/line} = \frac{\text{Freq. range}}{\text{Number of lines}} = \frac{2 \times \text{Freq. range}}{\text{Number of data points}}$$

$$\begin{aligned} \text{Frame period} &= \text{Number of data points/sample rate} \\ &= \text{Number of data points} \times \text{sampling interval} \end{aligned}$$

$$\text{Resolution/line} = 1/\text{Frame period}$$

◆ *Windows/Truncation.* When a frame of points is selected and used in an FFT analysis, the time for the initial point becomes the reference for the start of the sine and cosine waves used for the analysis. In addition, the standard transform uses the duration of the frame as the basic period for the analysis. The fundamental component in the analysis has a frequency that is the reciprocal of that basic period, and the frequencies of the other components are integer multiples of that fundamental.

If the actual signal from which the frame is taken is periodic, and if the duration of the frame is an integer multiple of the signal period, then the analysis can give excellent results without modification of the frame. Another way of stating this favorable situation is that the component frequencies of the actual signal are all integer multiples of the fundamental frequency corresponding to the frame period. This situation is unusual, however, and we need to look at the problems of a more general case.

There are a number of ways of looking at what happens in an analysis with a finite duration input. One approach uses the concept of a data or time window. The input signal is regarded as extending indefinitely in time, and the sampled frame can be regarded as the input signal looked at through a finite window in

time, or multiplied by a data window that is 0 everywhere except during the sampling period and then it is unity.

When a transform is made, the developed analysis fits the input frame of data correctly, but in doing so, it in effect is analyzing a signal that is the original frame continuously repeated. A simple example of what can happen is shown in Figure 8-17, where a sinewave has been sampled. The discontinuity at the ends leads to an extensive set of components in the analysis that may obscure or interfere with the components of interest. This effect is sometimes called "leakage." If the frame were changed to include more of the original signal, the discontinuity would be different, and the results of the analysis would be different. In this example, if the frame were set to coincide with the period of the sinusoid, there would be no discontinuity, and no difficulty would occur. We cannot, however, adjust the frame to fit any possible signal, because many are not periodic, and even for those that are we would not necessarily know what period to use. With a fixed frame, let us observe the response of the system as we vary the incoming signal frequency. With a rectangular window we will obtain a response of the form shown in Figure 8-18. This response shows the desired peak at f_0 when the applied signal and the frame fit correctly. When the frequency deviates from this optimum value, the response decreases.

Another way of looking at the problem is that the Fourier transform is designed to produce a set of functions that will combine to reproduce the original data. The discrete transform uses only a minimum number of these functions to reproduce these data and the behavior of the combined functions beyond the data window may not be what we would always desire. If we wish to control the behavior beyond the original window, we have to specify more data points outside the original set and thereby enlarge the window.

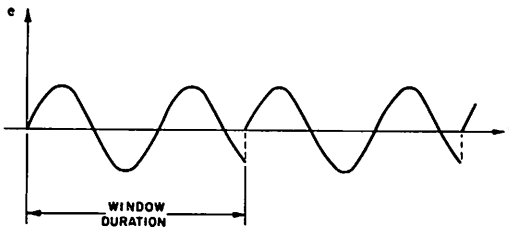

Figure 8-17. A repeated frame of data that shows the discontinuity that can occur when the window duration is not an integer multiple of the basic period of the sampled wave.

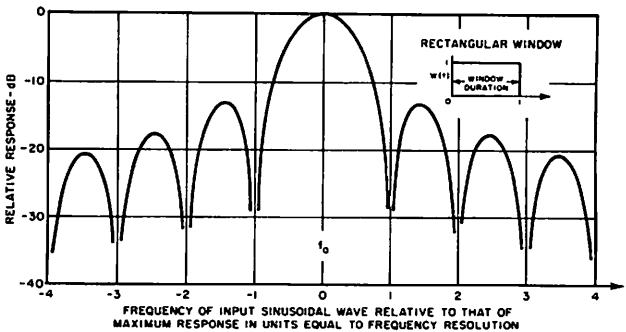

Figure 8-18. Effect of truncation with abrupt rectangular window on the response of the transform.

Several techniques have been developed to reduce the effects of "leakage" or of the finite window. The most commonly used one is a modification of the window to have a smooth transition from zero to the full value, instead of the abruptness of the rectangular window. The simple tapering of the "raised cosine" or the hanning window, shown in Figure 8-19, is the one most widely used, and it is very effective. The response now becomes as shown.

When hanning is used, the data at the ends of the frame are ignored, since they are multiplied by a value near zero. It is important then that the data window be positioned and made wide enough to ensure that the important behavior is centered within the window.

The tapered weighting used in hanning and other windows also broadens the main response of the transform. This broadening can be compensated for by increasing the number of points in the data frame.

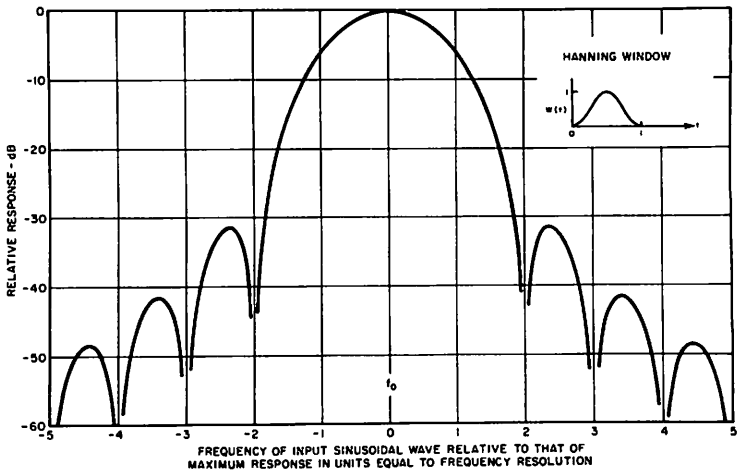

Figure 8-19. Effect of tapered window (hanning) on the response of the transform.

Reducing the effects of interfering components is so important that hanning or some similar tapered weighting should almost always be used.

◆ **Time Compression or Scaling.** When a serial type of analyzer is to be used to analyze a signal that changes with time, the signal is often first recorded on a tape recorder. Sections of the record are then selected, made into tape loops, and played back to the analyzer until the analyzer has had time to go through the desired range of analysis.

If the speed at which the tape loop is reproduced is different from the original recording speed, all the signal components are translated in frequency by the speed ratio, and the repetition period of the loop is changed by the inverse of this ratio. Thus, if we have a one-second loop recorded at $1\frac{7}{8}$ in./s and played back at 15 in./s, the loop will repeat every $\frac{1}{8}$ th of a second, and a 1000-Hz component will become an 8000-Hz component.

The loop when played back at its original speed repeats every second. The output signal will then have components that are spaced 1 Hz apart. The speeded-up loop will have components with 8-Hz spacing.

If we now analyze this speeded-up loop in third-octave bands, we use the band at 8000 Hz to find the value of the components in the original signal in the

1000-Hz band. The band at 8000 Hz is 8 times as wide as the one at 1000 Hz, and the response of its filter is correspondingly 8 times as fast. Now we can in effect process the signal 8 times as rapidly as at the original speed.

If the signal is converted into digital form, it can be stored in a circulating digital memory rather than in a tape loop. The speed-up that is then possible is many times greater, being 1000-to-1 or even more.

◆ **8.6.4 Frequency Translation or Heterodyning.** Both the serial and parallel types of analyzer can be operated over a wide range of input-signal frequencies by translating the input signal frequencies to be within the range of the analyzer. This technique has been widely used with serial analyzers to translate the effective center frequency of a single highly selective filter.

The technique is illustrated in Figure 8-20. Assume we are concerned with the signal components in the vicinity of 1000 Hz. A local oscillator in the device is set to generate a sinewave at 101 kHz. This wave is mixed with the incoming signal, and the resulting components, with frequencies in the immediate vicinity of 100 kHz, pass through the 100-kHz filter and are indicated by the detector system. The component in the original signal at 1000 Hz would be the principal component measured. But components at 100 kHz and at 201 kHz also produce an output at the detector, but they are excluded by filtering or other methods before the frequency translation occurs.

If the frequency of the local oscillator is changed, the input-signal frequencies of the components passed by the filter will also change. In this way, a 10-Hz wide filter at 100 kHz can be made to appear to be a 10-Hz wide filter at any desired frequency.

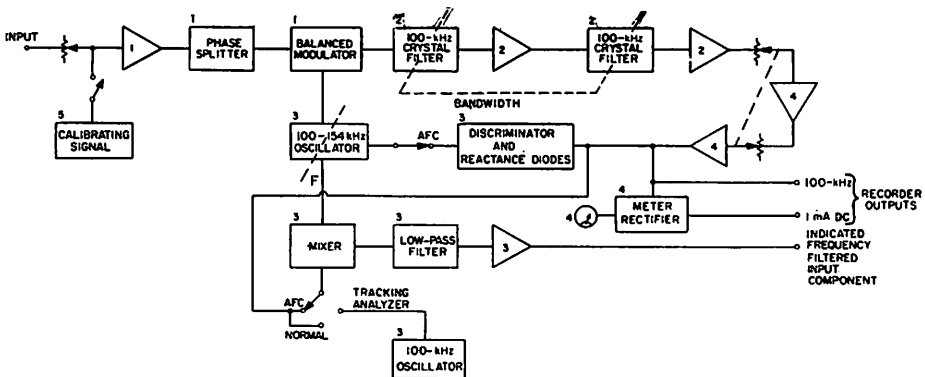

Figure 8-20. Block diagram, a heterodyne analyzer.

8.6.5 Zoom or Digital Frequency Translation. A technique related to heterodyning is now being used in digital systems for increasing the resolution of an analysis. The signal to be analyzed is translated in frequency by digital processing. It is filtered to restrict the bandwidth of the signal, and then it is analyzed by a Fast Fourier Transform. Increased resolution by factors up to 128 are sometimes provided. The additional detail requires the use of a correspondingly longer sample duration, and the phenomena being analyzed must be stable in order for the detailed analysis to be meaningful.

◆ 8.6.6 Analysis of Random Noise.

Effective Bandwidth. The actual filter characteristic in any of these systems is not ideal, in the sense of completely rejecting signal components outside the nominal passband. Modern filters can be made sufficiently good, however, that the difference in the results of an analysis, between using a filter with ideal characteristics and using the actual one, are ordinarily negligible for acoustical and vibration signals. In order to attain this behavior they must be designed with the correct effective bandwidth.

To determine the effective bandwidth of a filter, it is driven by a white-noise signal, which is a noise that is uniform in power-per-hertz-bandwidth over a very wide frequency range. The effective bandwidth is then the total output power divided by the output power for 1-Hz bandwidth at the frequency of maximum response. This can also be expressed as the equivalent-ideal-filter bandwidth, where the ideal filter is adjusted to have the same gain as the maximum gain of the actual filter.

The effective bandwidth for an actual filter can be designed to be a third-octave or whatever is required. The shape of the filter, and its actual width in the nominal pass band, are set to pass somewhat less noise to compensate for that passed by the filter outside the nominal band limits. Although this behavior is strictly correct only for white noise, with a good filter characteristic the behavior is also very good for noise spectra that are not uniform.

The effective bandwidth for noise, for a Fourier transform that yields auto-spectral values, is the sampling frequency divided by twice the number of points in the data frame. If a hanning window is used, however, the elementary bands, represented by the autospectral values, are each broadened by a factor of 1.5, or 1.8 dB, when referred to a sine wave. This factor is cancelled out if at least three adjacent bands are summed to provide a broader band, because the maximum response is increased by the same factor.

★ **Blurring Effect.** Many modern analyzers yield results for practical noises that are essentially those that would be obtained if ideal filters with infinitely steep attenuation characteristics could have been used. But sometimes the results from ideal filters are not ideal, or at least are not easily interpreted. Even an ideal filter “blurs” changes in spectrum level with frequency because of its finite bandwidth. This effect is illustrated by the analysis shown in Figure 8-21. The signal used here was developed by filtering “pink” noise, that is noise with equal energy per octave bandwidth. The pink noise was passed through a combination of low-pass

Figure 8-21. Blurring effect and excess level error for various bandwidths (slope = 60 dB/octave).

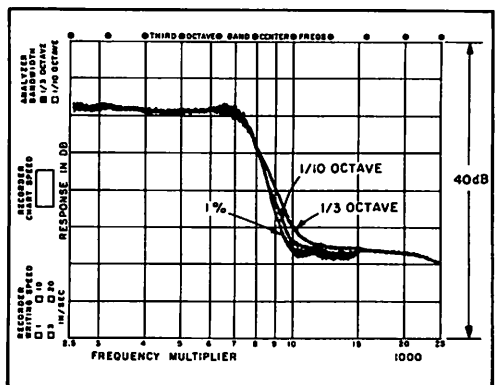

and high-pass filters to give an abrupt transition in spectrum level of about 20 dB. This transition occurred at a rate of about 60 dB/octave. This noise was analyzed with 1%, one-tenth-octave, and one-third-octave bandwidths. The recorded levels for each analysis were adjusted at the low frequency end to be alike (Kundert et al., 1969).

Calculations show that these analyzers are performing nearly as well as an ideal set. The analysis with the 1% bandwidth analyzer shows the true nature of the spectrum applied to the analyzers. The others show the effects of the wider bandwidths. There is an obvious rounding at the lower corner, and the wider the band used the more the corner is rounded.

The wider bands also show a shift in level, which will occur whenever the spectrum slopes steeply, because the energy passed by the filter, in the region where the level is high, will more than counterbalance the decrease in energy in the opposite region. This shift has sometimes been regarded as an apparent shift in the center frequency of the filter, but when levels are to be specified at preferred frequencies, it may be more convenient to think of it as a shift in level. The extent of the effect can be expressed as an excess in apparent spectrum level, and Figure 8-22 shows the results of calculations for various bandwidths and spectrum slopes. It illustrates the limited resolving power of wide filters even when ideal. This effect is important mainly when comparing results with analyzers of different bandwidths. For most practical noises, the effect is not great except for octave bands. For the one-third-octave band and the extremely steep slope in the example of Figure 8-21, the shift in level in the middle of the slope should be somewhat over 3 dB, which is essentially the shift observed.

A similar effect results in filling in a narrow dip and rounding off the top of a peak in a spectrum. It is merely what is to be expected from the limitations in resolution of a finite bandwidth.

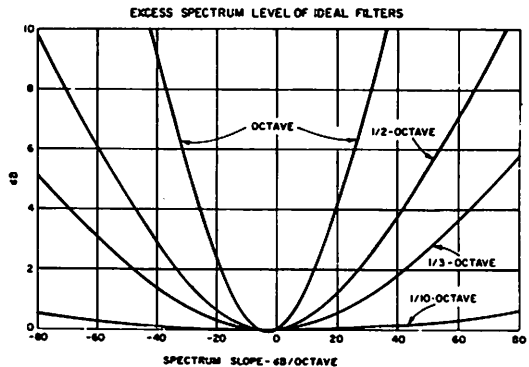

Figure 8-22. Excess level error for various bandwidths.

◆ *Degrees of Freedom/Spectrum Averaging.* Assume we analyze successive frames of sampled values of a random-noise signal. The results of a Fourier transform would show a very large variability in the indicated level in any one band, from one frame to the next. This variability is characteristic of a random signal (Bendat and Piersol, 1966; Sloane, 1969).

In order to produce values that have some significance for the band levels of noise, we must combine many samples. We can sum the corresponding squares of

the measured spectrum values (autospectra) for a number of frames, which we call averaging. We can sum the squares of the measured spectrum values for a number of adjacent bands, which reduces the resolution but improves the statistical stability. Or we can do both, that is, average and combine bands.

In order to show what needs to be done, we shall describe what happens with a white-noise signal of a given bandwidth, B , in Hz. If this is sampled at the Nyquist interval, we will get all the information available in the signal. If the frame of points is taken over a total time span T , we have a frame of $2 BT$ points. This value for bandwidth-limited Gaussian white noise is the number of statistically independent sampled values, which is sometimes called the number of degrees of freedom. It can be used to describe the expected behavior of the variability of the random signal.

If a complete Fourier transform of this frame is now made, each autospectral component (the sum of the squares of the amplitudes of the sine and cosine terms) will have two degrees of freedom. For each independent frame of data that is summed in, two degrees of freedom are added. Thus, if we had 32 autospectral values at 1000 Hz that we had summed (we could normalize by dividing by 32 to get the average), we would have 64 degrees of freedom. From the chart of Figure 8-23 we find that we would have a 95% confidence that the resultant level is not greater than the long-term true value by more than 1.4 dB or less than the true value by more than 1.6 dB.

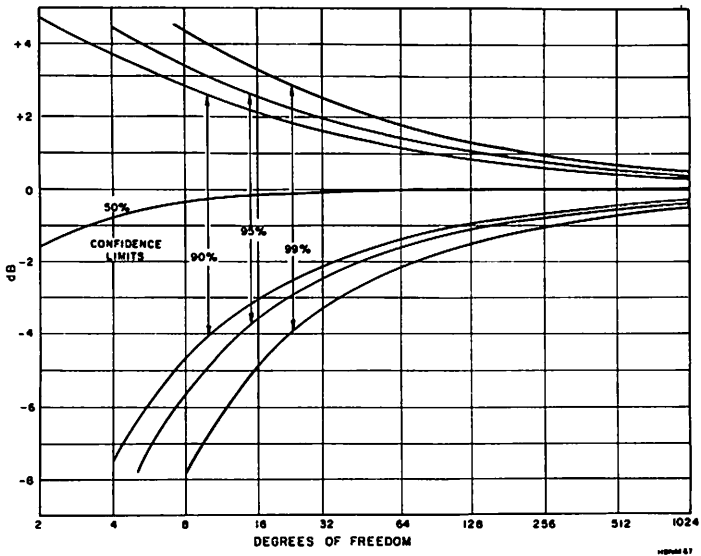

Figure 8-23. Reliability of amplitude analyses as a function of degrees of freedom from the data sample for various confidence limits.

The results of some measurements on white noise, with an FFT Analyzer, will illustrate what these statements mean. One hundred successive levels of the same single band of stationary noise were measured. Each of these 100 levels was a result of 32 averages. (The high-speed processing made it possible to get the 3200 measurements rapidly.) The measured levels were then arranged for plotting on probability paper as shown in Figure 8-24. The expected distributions for 32 and 64 degrees of freedom are also shown and they have been set at the level to give a

best fit to the observed data. The results show that any particular averaged level that uses 32 independent frames is very likely to be within a 3-dB span, as predicted. Similar results are shown for a measurement with a hanning window.

The total number of degrees of freedom for a frame of data is reduced by the use of a tapered window, such as hanning. Thus, if a number of adjacent bands are combined by summing the squares of the component values, the number of degrees of freedom will not be twice the number of bands that are combined. If hanning is used, it will approach only about one-half that value. If the noise is not white over the range of the combined bands, or if the noise is not essentially stationary over the time for the frame, the total number of degrees of freedom will be reduced even further.

The uncertainty in the results of a measurement discussed here is in addition to the other uncertainties discussed in Chapter 12.

Thus the chart of Figure 8-23 should be used mainly as a guide.

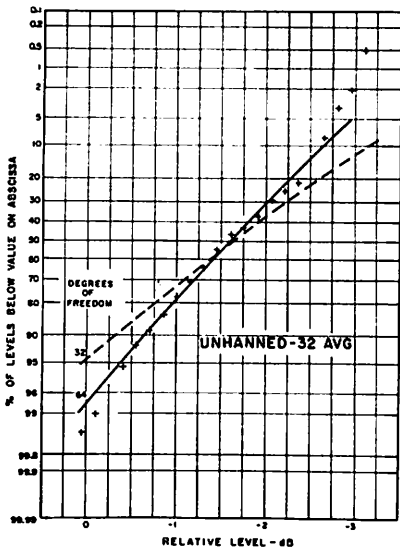

Figure 8-24. Comparison of the statistical stability of experimental measurements with theoretical curves for 32 and 64 degrees of freedom.

The summing and averaging that is used here is different from that used in waveform averaging (paragraph 8.4.5). In waveform averaging, the summing is linear and includes the sign, and therefore, random noise, which is random in value, will add up more slowly than a signal that is always of the same wave shape with respect to the starting point of the frame. Waveform averaging reduces random noise.

The averaged waveform will have the coherent signal emphasized with respect to the noise by a factor equal to the square root of the number of sums. This technique “pulls” a signal out of noise. If one were interested in the spectrum of the coherent signal only, waveform averaging before transforming to obtain a spectrum would be a good approach when it is possible.

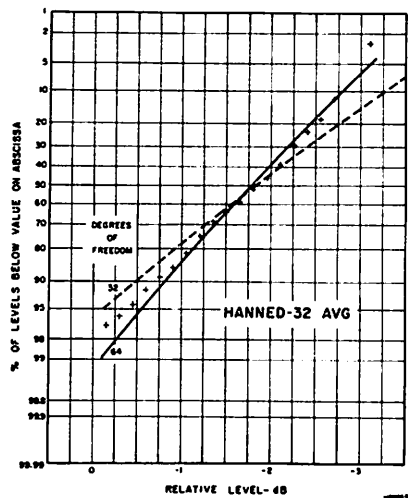

Figure 8-25. Comparison of the statistical stability of experimental measurements with theoretical curves for 32 and 64 degrees of freedom — hanning was used.

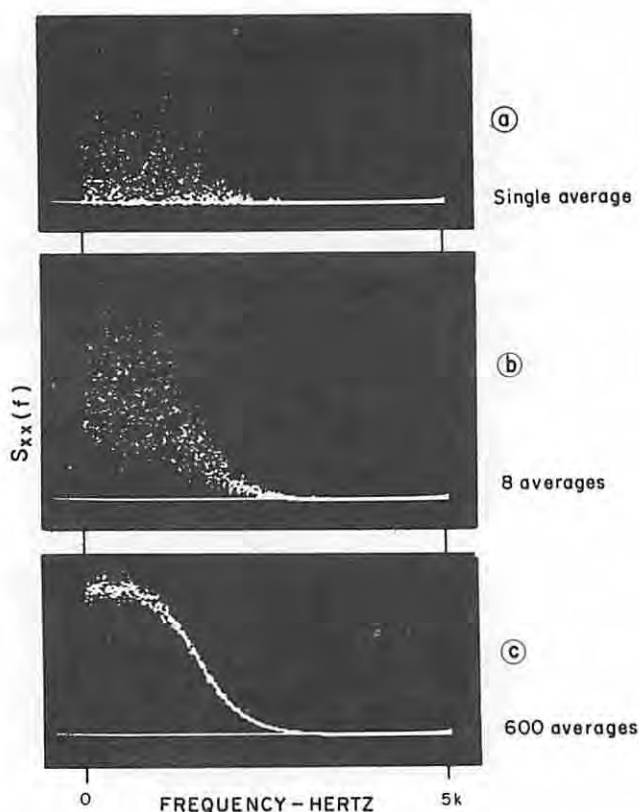

Figure 8-26. Averaged auto spectrum of band-limited noise.

The spectrum-averaging procedure used in this section sums the squares of the magnitudes of the components, and the sign does not enter, since the squared value is always positive. This spectrum averaging gives a more stable, that is, less variable, value for the spectrum levels of a random-noise signal, provided the noisy signal is stationary over the averaging period. When measurement of the noise level is important, as is often the case in acoustics, spectrum averaging makes possible a more reliable measurement of the level, as shown in Figure 8-26.

It is also interesting to note that spectrum averaging sometimes makes it possible to find a periodic signal that may otherwise be obscured by noise, provided the noise is stationary. The point involved here concerns the fact that a transform of a single frame yields spectrum levels for the noise that have only two degrees of freedom. The variability of level is then very large. A pure-tone component that is of the same order as the band level of the noise will appear as just another noise component among many in its vicinity that are similar in amplitude.

If many frames are averaged as shown in Figure 8-27, the noise-spectral values are more uniform in level. Then the effect of an added periodic component will be apparent by its projection beyond the relatively uniform amplitude of the average noise-spectral values in its vicinity. This averaging procedure is particularly appropriate when both periodic and random signals are important.

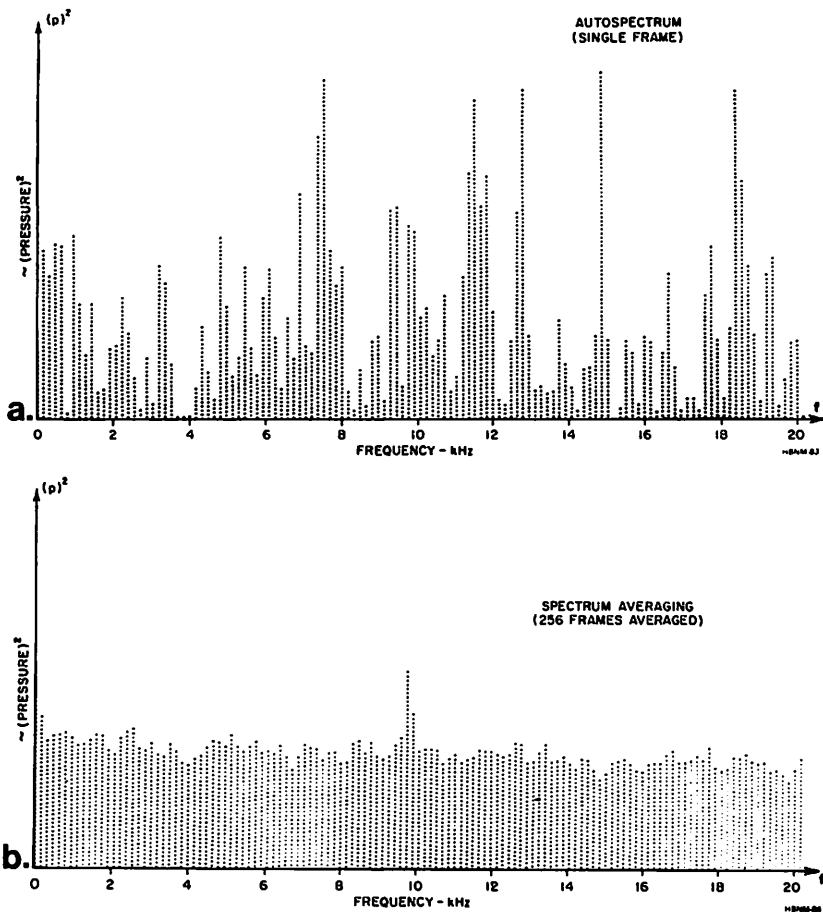

Figure 8-27. Autospectra of a signal that contains a sine wave buried in random noise. The autospectrum for a single frame is shown at (a), and the normalized average of the autospectra for 256 frames is shown at (b).

◆ *Statistical Stability in Analog Systems.* The measurement of random noise on an analog system involves essentially the same concepts as in a digital system. Now, however, the metering circuit provides some averaging, and two meter speeds are often provided in acoustic measuring instruments. These two speeds are designated fast and slow, with the slow condition yielding the longer averaging time.

The fact that an averaging time is used leads to a dependence of the statistical stability on bandwidth. That is, if a random noise is analyzed with an analog system, the extent of the meter fluctuations depends on the bandwidth. The narrower the band, the greater are the fluctuations and the longer is the averaging time required for a satisfactory estimate of the level.

A relatively simple principle is involved here. A narrow band is used to get fineness of detail. The finer the detail that is desired, the more time is needed to obtain the result to a certain degree of confidence.

◆ *Example of Random-Noise Measurement.* To illustrate by an actual numerical example the type of behavior that occurs, some measurements were made of

an arbitrary level of a random-noise generator in the octave band from 150 to 300 Hz. With the fast meter speed, the average of the fluctuating levels indicated on the meter was estimated to be about +5 dB, where in a period of 30 seconds the level fluctuated from a minimum of +3.3 dB to a maximum of +6.5 dB, a range of 3.2 dB. In the slow position the estimated level was +4.7 dB, and the level fluctuated over a three-minute period from a minimum of +3.8 to a maximum of +5.7, a range of 1.9 dB. Some sample readings were as follows: fast position: 4.8, 4.1, 5.3, 3.7, 5.8, 4.9, 5.3, 5.2, 6.2, 4.6; slow position: 4.4, 5.1, 3.9, 4.9, 4.2, 5.0, 4.7, 4.1, 4.3, 4.9. (These sample readings were taken with the help of a stroboscope, to avoid observer bias in selecting readings and to make it possible to take definite readings on the rapidly moving pointer in the fast position.) One hundred samples were taken for each position. The average value on an energy basis for slow was +4.72, with the lowest reading +3.8 and the highest +5.8; The average for fast was +4.74, with a low reading of +3.1 and a high reading of +6.2.

Taking such a set of readings is not the usual way to obtain the indicated level; rather, one estimates a value by observing the pointer fluctuations. But these discrete samples permit one to describe statistically the behavior that can be expected.

For the fast position one would expect only 1 in 1000 readings to differ from the average by more than about -3 dB or +2.4 dB, a range of 5.4 dB. The corresponding extremes for one chance in 100 is about -2.3 dB or +1.9 dB, a range of 4.2 dB; for 1 in 10, about -1.4 to +1.2, a range of 2.6 dB. Note that the range is not symmetrical.

These statements about variability can be expressed in another way, which is the converse of that above. If any reading is taken in the fast position, the chances are only 1 in 100 that the long-time average value of the noise is below the observed value by more than 1.9 dB or above the observed value by more than 2.3 dB. These limits are called the 99% confidence limits.

Confidence Limits for Octave Bands. A chart of the 99% confidence limits for octave bands for random noise measurement is given in Table 8-4.

These ranges of uncertainty can be reduced by the use of the average of a number of independent readings. The reduction in the range is approximately inversely proportional to the square root of the number of independent observations. Thus, the average of four observations would reduce the uncertainty to about one-half that shown.

Table 8-4
CONFIDENCE LIMITS FOR RANDOM
NOISE IN OCTAVE BANDS

| Center Freq (Hz) | 99% Confidence Limits (dB) Meter Speed | |
|---------------------|---|------------|
| | Fast | Slow |
| 31.5 | -4.2, +7.0 | -2.5, +3.3 |
| 63 | -3.2, +4.7 | -1.8, +2.2 |
| 125 | -2.4, +3.1 | -1.3, +1.5 |
| 250 | -1.7, +2.1 | -1.0, +1.1 |
| 500 | -1.2, +1.4 | -0.7, +0.7 |
| 1,000 | -0.9, +1.0 | -0.5, +0.5 |
| 2,000 | -0.6, +0.7 | -0.3, +0.3 |
| 4,000 | -0.5, +0.5 | -0.2, +0.2 |
| 8,000 | -0.3, +0.3 | -0.2, +0.2 |
| 16,000 | -0.2, +0.2 | -0.1, +0.1 |

The range of uncertainty discussed here is sometimes called the statistical error and it is in addition to the other uncertainties discussed in Chapter 12.

Averaging By Observation. When one observes the fluctuations of a meter for a time and estimates an average, the extent of the reduction of the uncertainty is limited by the fact that all the observations are not independent, and one can remember and use only a small portion of the total observed behavior. The observations are not independent because of the finite time required for the pointer to assume a new value. In the fast position of the meter, one should allow about one-half second between observations; in the slow position, an interval of one to two seconds is desirable.

Duration of a Sample. The uncertainty that results from the limited observation time, in comparison with the detail desired in the frequency domain, occurs for other time limitations as well. Moreover, some of these may not be under the control of the operator. Thus, the sound source may not perform uniformly over an extended period of time; for example, a rocket may run for only a fraction of a minute. During launch, the time available for observing a rocket may be only a few seconds or less.

When a noise signal, recorded on a magnetic-tape recorder, is to be studied, it is customary to take short samples for analysis. These samples are cut from the full recording and formed into loops that can be run continuously in the recorder. This procedure directly limits the fineness of detail possible in the analysis and also limits the accuracy with which one can determine the actual level in a band.

This limitation of accuracy results from the fact that the maximum time during which independent information can be obtained is the sample duration. If the noise is sufficiently uniform with time, a longer sample can be used to obtain increased accuracy, or measurements on a number of samples can be averaged.

Because of the inherent variability of random noise, analyses of distinct samples of the same noise will not yield identical results. The expected spread in values predicted by statistical theory can be used as a guide in judging whether the results of such analyses agree well enough to be useful. Unless this inherent variability is appreciated, one can be led into rejecting useful data, rejecting a useful analysis system, or placing too much reliance on a particular measurement.

Fluctuations Produced in Practice. The table of values shown for the octave bands is based on the analysis of noise that is uniform in energy per hertz throughout the band. In the wider bands, the values shown are misleading for acoustical signals, because the energy is not uniformly distributed. One should expect from such values that, when the full range of a sound-level meter is used, the fluctuations would be a small fraction of a decibel. As a matter of fact, one can find many examples of an over-all sound level that fluctuates over many decibels.

One example is the background noise of private offices. Here, for C weighting in the slow meter position, one can commonly find fluctuations of three or more decibels. The fluctuation corresponds to a band that is only tens of hertz wide rather than 8000 to 10,000 hertz wide, such as that of the response of the sound-level meter. This is because the energy in the sound is concentrated in the low frequencies over a relatively narrow band. The fluctuations reflect only the relation between the equivalent frequency band of the signal applied to the metering circuit and the averaging time of the circuit. Whether the energy is concentrated in a narrow band by means of an electrical analyzer or by the source and the path to the microphone is immaterial.

Interpretation of Fluctuations. One can conclude, then, that if the observed fluctuations are significantly greater than would be expected, an important part

of the random-noise energy is concentrated in a band or bands that are narrower than the pass band of the measuring system. (Another possibility is that the type of noise is sufficiently different from normal that the fluctuations for a given bandwidth are inherently excessive. This behavior is possible for a tone whose frequency varies in a region where the response of the measuring system varies markedly with frequency.) It is also clear that if the fluctuations are significantly smaller than would be expected, the noise very likely includes some discrete tones that have significant amounts of energy.

8.6.7 Speed of Processing — “Real Time.” If an analyzer can operate to process the input signal continuously, it is often called a “real-time” analyzer. This type of operation usually requires a parallel type of analyzer or some storage system. The accuracy and frequency range over which it may operate in real time is usually significant, particularly with digital equipment, and the cost usually increases with the speed and accuracy.

In an FFT system, which operates on discrete frames of data, real-time operation requires what is called “buffered-mode” operation. Here one frame of data is being stored while another is being processed. Then, if the processing can be done within the time taken to acquire a frame of input data, real-time operation is possible. Since many noise analyzers require that a number of spectra be summed, the real-time operation with the buffered mode can make it possible to utilize the full data available in a given time.

The real-time feature is particularly important for signals that vary in character with time, for example, the sounds from aircraft, missiles, speech, music, and many machinery operations, and when it is unproductive to tape record the sounds for later analysis.

Other definitions of real time have been used, and the basic requirement seems to be that the operation must be completed quickly enough to suit the application at hand. The user must recognize this time factor as another element in his choice of analysis equipment. To illustrate the range of times involved, consider the problems of analysis with a 10-Hz band over the range from 20 Hz to 20000 Hz. A serial analyzer will take about 1000 to 2000 times the time required for a very fast FFT system to do the basic processing.

8.6.8 Dynamic Range. The dynamic range of an analyzer is set by an upper limit of distortion and a lower limit of internal noise, selectivity, or arithmetic processing errors. If a signal that is too high in level is applied to an analyzer, the analyzer will be overloaded. As a result of the overload, the indicated spectrum will be different from the actual spectrum. How seriously the spectrum is distorted depends on the way in which the overload occurs. But, ordinarily one can avoid overloading by the use of reasonable care in following the procedures given in the instructions for the analyzer.

Internal noise of an analyzer is often a lower limiting factor in the analysis range possible. Unless this internal noise is significantly less than the applied signal, it can affect the indicated spectrum. The selectivity characteristic of the analyzer also limits the range, particularly close in frequency to strong components. In addition, some analyzers, particularly older designs, have ultimate rejection of components outside the passbands of only 30 to 40 dB.

Other factors that enter into the dynamic range of digital systems are aliasing and quantization, which are discussed in paragraph 8.3. A factor that is related to the quantization is the detail of arithmetic processing. For example, in additions, subtractions or multiplications, it is frequently necessary to maintain a constant

number of bits in the results. If this is done by simple truncation or dissymmetrical rounding, the noise introduced is usually greater than for symmetrical rounding. An even more important effect can occur in squaring the amplitudes of components, as is done for autospectral values. Sometimes the squared values are limited to the same number of bits as the basic values, in order to save storage space. This procedure can result in the loss of all information for low-level components and effectively reduce the dynamic range by a factor of two.

8.7 TWO-SIGNAL FUNCTIONS.

♦ **8.7.1 Cross Spectrum and Cross-Correlation.** A number of functions show relations between two signals. We have already briefly described cross-correlation which expresses the similarity of two signals as a function of time. A related function is cross spectrum, which is the Fourier transform of the cross-correlation and expresses the similarity as a function of frequency.

The cross-spectral function can also be calculated from the Fourier transforms of the two time series by a conjugate multiplication. This type of multiplication gives the products of the magnitude and the differences of the phases of the two signals. The alternative routes to the cross-spectral function are shown in Figure 8-28 (Heizman, 1970). One of the important applications of the cross spectrum is in the calculation of the transfer function.

Just as for autocorrelation and cross-correlation, the autospectrum and the cross spectrum are related in that the autospectrum is the cross spectrum with both signals being the same.

However, it would be wasteful to calculate the auto spectrum by either process shown in Figure 8-28, since the only output is the square of the magnitude of the components and only one transform is necessary for the autospectrum.

8.7.2 Transfer Functions and Coherence. The transfer function of a device or a system is the ratio of the output to the input. This function, which is ordinarily defined in the frequency domain, can be useful for studying noise and vibration problems. If we have the frequency analysis of both the input and the output signals, we can then have the transfer function by taking the ratio of the output to the input at each corresponding frequency component.

It is easy to see that we can select many different points in a system to be the

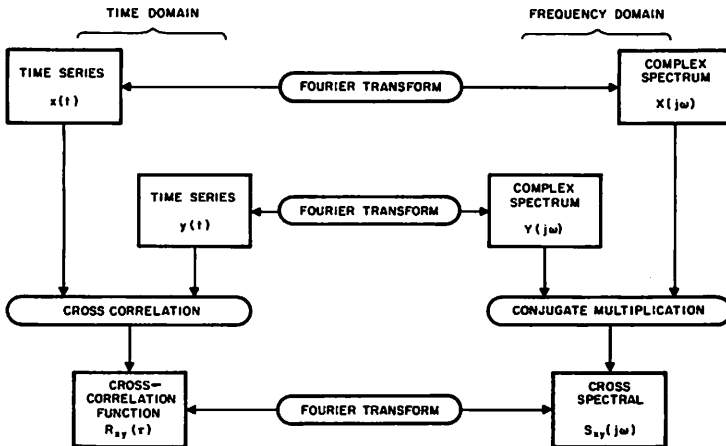

Figure 8-28. Time/frequency-domain diagram.

output. Assume we have an electrically driven hydraulic pump that is in an enclosure. We are concerned about the noise and vibration that it produces. What do we regard as the output? It could be the acoustic noise at various places outside the enclosure, or inside the enclosure. It could be the vibration at the pump housing or the vibration of the pipes.

We can look at the input in a similar way. If we are interested in the noise outside the enclosure, it is hardly useful to regard the electrical-power-line terminals as the input. The vibration at various points on the pump or on the pipes could be useful as an input, for the noise outside the enclosure as the output.

In most practical acoustical and vibration problems, enough extraneous noises are present to make the simple measurement of the transfer function unreliable. By the use of an alternative form of the transfer function, these extraneous effects can be reduced. The transfer function is also the ratio of the cross spectrum of the input and output to the autospectrum of the input (Sloane, 1970; Roth, 1971). The use of the cross spectrum, which includes those components that are common to both input and output, eliminates any extraneous components that do not appear in both.

Another function that is related to the transfer function is the coherence function. It is normalized by including the input and output in both numerator and denominator, as opposed to the transfer function, which has only the input in the denominator. The coherence function is the ratio of the square of the magnitude of the cross spectrum to the product of the input and output auto spectrums. The coherence function covers a range of magnitudes from 0 to 1 as a function of frequency, and the value depends on how well the input and output values at each frequency are related. It provides a useful further parameter to help in interpreting the transfer function.

The combination of transfer and coherence functions provides a powerful technique in the study of noise sources and transmission paths.

8.8 ANALOG VS. DIGITAL.

In an analog filter system, each filter band is essentially a separate element or is achieved by individual tuning. This technique is well suited for processing of, say, 8 octave bands or 30 third-octave bands or for serial analysis. Analog equipment for these tasks is available with excellent characteristics and at lower cost than for digital equipment.

In a digital system that uses the Fast Fourier Transform, a whole series of filter bands is achieved by the one transform. The difference then between 32 or 2048 filter bands is mainly a matter of memory size. Accordingly, digital techniques become preferred as the desired number of filter bands increases.

In addition, many types of operations on the data are often easy to include once the data is in digital form. Examples of these are averaging, addition of corrections, combining bands in different ways to give both narrow bands and third-octave bands, use of weightings of various kinds either in the time domain or the frequency domain, and calculation of noise ratings. In other words digital equipment is more flexible than analog equipment.

Digital processing can have very high resolution, has unlimited repeatability, can handle vast amounts of data, and is almost insensitive to environmental factors such as ambient temperature and pressure.

Since the original signal is in analog form, some processing is often conveniently done by analog techniques before sampling and conversion to a digital form. The system is then a hybrid one and may combine some of the desirable features of both techniques.

REFERENCES

Standards

- ANSI S1.11-1966, Specification for Octave, Half-Octave, and Third-Octave Band Filter Sets.
- ANSI S2.10-1971, Methods for Analysis and Presentation of Shock and Vibration Data.
- IEC 225-1966, Octave, half-octave and third-octave band filters intended for the analysis of sounds and vibrations.

Other

- W.B. Allen and E.C. Westerfield (1964), "Digital Compressed-Time Correlators and Matched Filters for Active Sonar," *J Acoust Soc Am*, Vol 36, #1, Jan, pp 121-139.
- N.A. Anstey (1966), "Correlation Techniques — A Review," *J Can Soc Explor Geophys*, Vol 2, #1, Dec 1966, pp 1-28 and *Geophys Prospecting*, Vol 12, #4, 1964.
- P.K. Baade (1966), "Instrumentation Trends for Noise Reduction, as Seen by a Mechanical Engineer," *J Audio Eng Soc*, Vol 14, #4, Oct, pp 302-306.
- C.G. Balachandran and D.W. Robinson (1967/68), "Diffusion of the Decaying Sound Field," *Acustica*, Vol 19, #5, pp 245-257.
- J.S. Bendat and A.G. Piersol (1966), *Measurement and Analysis of Random Data*, John Wiley and Sons, New York.
- W.V. Bhat (1971), "Use of Correlation Technique for Estimating In-flight Noise Radiated by Wing-mounted Jet Engines on a Fuselage," *J Sound and Vib*, Vol 17, #3, pp 349-355.
- C. Bingham, M.D. Godfrey and J.W. Tukey (1967), "Modern Techniques of Power Spectrum Estimation," *IEEE Trans on Audio Electroacoust*, Vol AU-15, #2, June, pp 56-66.
- R.B. Blackman and J.W. Tukey (1958), *The Measurement of Power Spectra*, Dover Publications, Inc., New York.
- R. Bracewell (1965), *The Fourier Transform and Its Applications*, McGraw-Hill, New York.
- A.N. Burd (1964), "Correlation Techniques in Studio Testing," *Radio and Elec Engineer*, Vol 27, #5, May, pp 387-395.
- A.N. Burd (1968), "The Measurement of Sound Insulation in the Presence of Flanking Paths," *J Sound and Vib*, Vol 7, #1, January 1968, pp 13-26.
- L.J. Chamberlain (1971), "A Simple Discussion of Time-Series Analysis," *Sound and Vibration*, Vol 5, #4, April 1971, pp 18-25.
- W.A. Clark, R.M. Brown, M.H. Goldstein, Jr., C.E. Molnar, D.F. O'Brien, and H.E. Ziemann (1961), "The Average Response Computer (ARC): A Digital Device for Computing Averages and Amplitude and Time Histograms of Electrophysiological Response," *IRE Trans on Bio-Medical Electronics*, Vol BME-8, #1, Jan, pp 46-51.
- R.K. Cook, R.V. Waterhouse, R.D. Berendt, S. Edelman, and M.C. Thompson, Jr. (1955), "Measurement of Correlation Co-efficients in Reverberant Sound Fields," *J Acoust Soc Am*, Vol 27, #6, Nov, pp 1072-1077.
- G.R. Cooper and D.C. McGillem (1967), *Methods of Signal and System Analysis*, Holt, Rinehart and Winston, Inc., New York.
- P.W. Cooper (1964), "Correlation Detection in a Duovelocity Medium with Application to Seismic Disturbances," *J Acoust Soc Am*, Vol 36, #7, July, pp 1378-1382.
- L.D. Enochson and R.K. Otnes (1968), *Programming and Analysis for Digital Time Series Data*, Navy Publication and Printing Service Office, Washington, DC 20390.
- J.J. Faran, Jr. (1968), "Random-Noise Generators," *General Radio Experimenter*, Vol 42, #1, Jan, pp 3-13.
- J.J. Faran, Jr., and R. Hills (1952a), "Correlators for Signal Reception," Tech Memo 27, Sept, Acoustics Res Lab Div. App Sci, Harvard Un, Cambridge, Mass.
- J.J. Faran, Jr., and R. Hills (1952b), "The Application of Correlation Techniques to Acoustic Receiving Systems," Tech. Memo #28, Nov., Acoustics Res Lab, Div. Appl Sci, Harvard Un, Cambridge, Mass.
- C.D. Geisler and W.A. Rosenblith (1962), "Average Responses to Clicks Recorded from the Human Scalp," *J Acoust Soc Am*, Vol 34, #1, Jan, pp 125-127.
- D.A. Gilbrech and R.C. Binder (1958), "Portable Instrument for Locating Noise Sources in Mechanical Equipment," *J Acoust Soc Am*, Vol 30, #9, Sept, pp 842-846.
- K.W. Goff (1955), "Application of Correlation Techniques to Some Acoustic Measurements," *J Acoust Soc Am*, Vol 27, #2, Mar, pp 236-246.
- B. Gold and C.M. Rader (1969), *Digital Processing of Signals*, McGraw-Hill, New York.
- A. Hannavy (1967), "New Detection Devices Help Predict Potential Failure," *Prod Engineering*, Mar 27, pp 37-44.
- C.L. Heizman (1970), "Signal Analysis with Digital Time Series Analyzers," *General Radio Experimenter*, Vol 44, #7-9, July-Sept, pp 3-7.

- C.W. Horton, Sr. (1969), *Signal Processing of Underwater Acoustic Waves*, U.S. Gov't Printing Office, Washington, DC 20402.
- S. Imai (1968), "On a Simplified Hybrid Analog-Digital Correlator for Sound Measurements," Reports of the 6th Inter Cong on Acoust, Tokyo, Aug, pp E-13-16.
- T.C. Kincaid (1968), "Optimum Waveforms for Correlation Detection in the Sonar Environment: Noise-Limited Conditions," *J Acoust Soc Am*, Vol 43, #2, Feb, pp 258-268.
- G.A. Korn (1966), *Random-Process Simulation and Measurements*, McGraw-Hill, New York.
- W.R. Kundert and A.P.G. Peterson (1969), "Spectrum Analysis of Stationary Noise Signals," *Sound and Vibration*, Vol 3, #6, June, pp 16-24.
- F.F. Kuo and J.F. Kaiser (1966), *System Analysis by Digital Computer*, John Wiley & Sons, Inc., New York.
- H.F.H. Lange (1967), *Correlation Techniques*, Iliffe Books Ltd, London, and D. Van Nostrand Company, New York.
- B.P. Lathi (1965), *Signals, Systems and Communication*, John Wiley & Sons, Inc., New York.
- Y.W. Lee (1960), *Statistical Theory of Communication*, John Wiley & Sons, Inc., New York.
- G.C. Maling, Jr., W.T. Morrey and W.W. Lang (1967), "Digital Determination of Third-Octave and Full-Octave Spectra of Acoustical Noise," *IEEE Trans Audio Electroacous*, Vol AU-15, #2, June, pp 98-104.
- D. Middleton (1960), *An Introduction to Statistical Communication Theory*, McGraw-Hill, New York.
- S. Nakamura and M. Koyasu (1968), "Measurements of the Vibration Correlation between Both Surfaces of a Multi-Layer Panel," *Reports of the 6th International Congress on Acoustics*, Tokyo, Aug, pp E-125-128.
- D.A. Nelson and F.M. Lassman (1968), "Effects of Intersignal Interval on the Human Auditory Evoked Response," *J Acoust Soc Am*, Vol 44, #6, Dec, pp 1529-1532.
- A.V. Oppenheim, ed (1969), *Papers on Digital Signal Processing*, The M.I.T. Press, Cambridge, Mass.
- R.K. Otnes and L. Enochson (1972), *Digital Time Series Analysis*, Wiley-Interscience, N.Y.
- A.G. Piersol (1967), "Practical Interpretations of Unusual Characteristics in Reduced Vibration Data," *J Env Sci*, Vol 10, #1, Feb, pp 17-21.
- P.R. Roth (1971), "Effective Measurements Using Digital Signal Analysis," *IEEE Spectrum*, Vol 8, #4, April, pp 62-70.
- H.H. Rothman (1970), "Effects of High Frequencies and Intersubject Variability on the Auditory-Evoked Critical Response," *J Acoust Soc Am*, Vol 47, #2 (Part 2), February 1970, pp 569-573.
- R.C. Singleton (1969), "A Short Bibliography on the Fast Fourier Transform," *IEEE Trans Audio Electroacous*, Vol AU-17, #2, June, pp 166-169.
- E.A. Sloane (1966), "An Introduction to Time-Series Analysis," Monographs I, II, and III, Time/Data Corporation, Palo Alto, Calif.
- E. A. Sloane (1968), "The Effects of Quantization on Small Signals," Technical Bulletin No. 1, Time/Data Corporation, Palo Alto, Calif.
- E.A. Sloane (1969), "Comparison of Linearly and Quadratically Modified Spectral Estimates of Gaussian Signals," *IEEE Trans Audio Electroacous*, Vol AU-17, #2, June, pp 133-137.
- E.A. Sloane (1970), "Measurement of Transfer Function and Impedance," *General Radio Experimenter*, Vol 44, #7-9, July-Sept, pp 8-13.
- M.W. Smith and R.F. Lambert (1960), "Acoustical Signal Detection in Turbulent Airflow," *J Acoust Soc Am*, Vol 32, #7, July, pp 858-866.
- R.A. Thompson and B. Weichbrodt (1969), "Gear Diagnostics and Wear Detection," ASME Vibration Conference Paper #69-VIBR-10, and *Machine Design*, Vol 41, May 15, pp 181-183.
- I. Tolstoy and C.S. Clay (1966), *Ocean Acoustics*, McGraw-Hill, New York.
- P.H. White (1969), "Cross Correlation in Structural Systems: Dispersion and Nondispersion Waves," *J Acoust Soc Am*, Vol 45, #5, May, pp 1118-1128.
- B. Widrow (1961), "Statistical Analysis of Amplitude-Quantized Sampled Data Systems," *AIEE Trans*, Vol 79, Part II, *Applications and Industry*, 1960, Jan, pp 555-568.
- J.F. Wilby and F.L. Gloyna (1970), "Correlation Measurements of Airplane Fuselage Vibrations," *J Acoust Soc Am*, Vol 48, #1 (Part 1), July, p 80.

Chapter 9

Analyzers (Spectrum Analyzers)

Even if a sound-level meter were perfect (i.e. fit with no tolerance all the design objectives of the ANSI or IEC Standards), the reading obtained by it in any given noise field is inadequate for a complete understanding of the problem. The number of decibels indicated by a sound-level meter tells nothing about the frequency distribution of the noise. It is true that by judicious use of the weighting networks in a sound-level meter one can learn something about the frequencies present, but this knowledge is only qualitative. For most important problems it is necessary to use some type of frequency analyzer to determine the noise spectrum, as described in Chapter 8. It is also often helpful to measure the correlation of two noise signals, the transfer and coherence functions, and the other measures described in Chapter 8.

The vibration meter measures the displacement, velocity, acceleration, or jerk of a vibration. Unless the waveform is substantially sinusoidal, however, the vibration meter by itself gives little information about the frequencies of the individual vibration components. An analyzer, therefore, is desirable and often is a necessity. As with noise, the analysis of vibration provides clues to the sources of the vibration components and information necessary in the suppression of the vibration.

A number of analyzers are available for use with the sound-level meter or the vibration meter or for use with microphones and vibration pickups directly or with preamplifiers. These analyzers vary in cost, complexity, and ease of operation. Choice among them is generally determined by the amount of detailed information needed, the speed of processing required, the nature of the output format, and the auxiliary processing that may be required.

The simple, serial analyzers will be described first. These analyzers can be hand operated, and the band levels can be read from an attenuator setting and a meter reading. Some of them can also be coupled to recorders to yield a descriptive plot of the band levels as a function of frequency.

The analyzing systems that can provide detailed data rapidly will then be described.

9.1 OCTAVE-BAND ANALYZERS.

The Type 1982 and the Type 1933 Precision Sound Level Meter and Analyzers, shown in Figure 9-1, include an octave-band filter set that makes possible the simple and rapid analysis of noises having complex spectra (Kundert and Marteney, 1971). As described in Chapter 11, they are widely used for frequency analysis of noise, particularly for product rating, production-line testing, preventive maintenance, checking for compliance with some ordinances, and for estimating some subjective effects (see Chapter 4).

These portable, battery-operated instruments are complete sound-level meters, each with a microphone, a preamplifier, an attenuator, weighting networks, an amplifier (which drives the filters), an indicating meter, and monitoring outputs. The set of octave-band-pass filters, selected by means of a rotary switch, range in

center frequency from 31.5 to 16,000 Hz. The direct-reading level range for the 1933 with the microphones supplied is 10 to 140 dB re 20 μ Pa (30 to 130 dB for the 1982). The filters meet the requirements of ANSI S1.11-1966, Class II.



Figure 9-1. Sound level meters that include octave-band filter sets.

9.2 ONE-THIRD-OCTAVE-BANDWIDTH ANALYZER.

A one-third-octave bandwidth analyzer is often used for a more detailed analysis of noise than that obtainable with an octave-band analyzer. Third-octave analysis is now widely used, particularly for checking compliance with noise and vibration specifications. It is most often used with a recorder to give a graph of the energy distribution of the noise or vibration as a function of frequency.

Some third-octave analyzers are arranged to analyze in serial fashion, where the levels in the bands are determined one at a time in succession. This process is a slow one, but it is adequate for situations where the noise does not change in character during the full time required for the analysis.



Figure 9-2. A one-third octave real-time analyzer.

9.2.1 REAL-TIME ONE-THIRD OCTAVE ANALYSIS.

In order to achieve the most rapid one-third-octave analysis, a complete set of filters must be driven in parallel. This technique is used in the Type 1995 Integrating Real-Time Analyzer, shown in Figure 9-2. This analyzer measures and displays on a video monitor (CRT) one-third octave and full octave bands from 25 Hz to 20 kHz as well as the A-weighted and FLAT levels (see Figure 9-3). An extended range version permits a choice of 2.5 Hz to 2000 Hz or 25 Hz to 20 kHz analyzed in 30 one-third-octave bands. A wide variety of operating conditions can be selected by control buttons on the front panel keyboard. Since the instrument can be battery or line operated, it can be used in the field or in the laboratory.

All measurement results and basic selected measurement parameters are displayed on the built-in video monitor. The displayed band levels can be shown as a bar graph or in a numerical listing (see Figure 9-4). Octave band values, which are calculated from the one-third-octave band levels, can also be displayed.

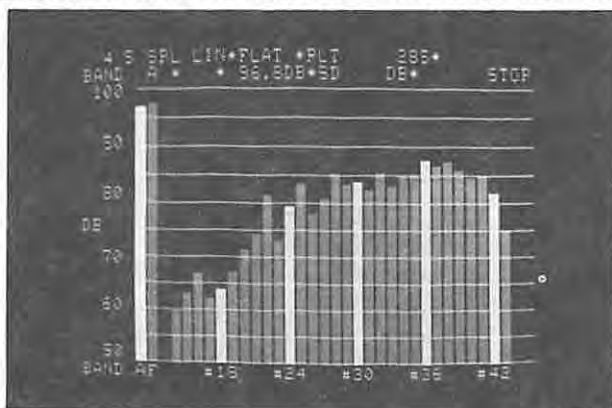

Figure 9-3. Graphical display of the band levels measured on the GR 1995 Integrating Real-Time Analyzer.

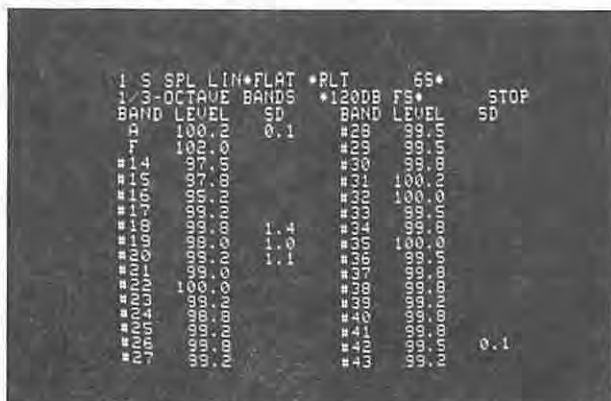

Figure 9-4. Numerical listing of levels measured on GR 1995.

A microphone/preamplifier combination normally supplies the signal for the analyzer, which can then measure from 20 dB to 140 dB sound-pressure level. Any 50-dB range within those limits can be displayed.

Exponential and linear integration are available. In the exponential mode, any of 24 time constants from 1/8 second to 24 minutes can be selected. Since the

1/8-second and 1-second exponential time constants correspond to FAST and SLOW sound-level meter responses, a choice of one of them allows direct comparison with sound-level-meter data.

In the linear integration mode, any of 35 integration times from 1/8 second to 24 hours can be selected. One of these integration modes is an averaging mode, which is the same as equivalent level (L_{eq}). Another references the integration to one-second, and it is called "Sound Exposure Level" or SEL. This SEL mode is particularly useful for transient or short duration signals.

A measured spectrum can be saved for later reference by pushing the STORE button. It can then be recalled and displayed alone or with another spectrum that has subsequently been measured. These spectra are retained even when the instrument power is turned off.

A maximum spectrum, which is a composite derived from the maximum sampled levels in each band taken as the integration proceeds, can also be displayed.

The level in any selected one-third-octave band, the A-weighted or the FLAT level can be displayed as a function of time. Up to 32 measurement periods can be displayed. For example, up to 32 hourly, A-weighted, L_{eq} measured values can be displayed. Or, for rapidly occurring events the 1/8-second integration will show 4 seconds of information. The display can be set to "freeze" after 32 periods or to update continually by dropping the level in the oldest period as each new period is completed.

A cumulative mode facilitates space averaging for sound power measurements. If, for example, a space average at eight locations about a machine are required, and a four-second integration is used to obtain a total of 32 seconds of averaging, the cumulative mode is selected. The spectrum is measured at the first microphone location. The microphone is then moved to the next location, and the integration is continued. This operation is repeated until all the locations have been covered. The instrument will then have averaged all the results together. This mode of operation can be used to measure in accordance with the EPA Noise Emission Standards for Portable Air Compressors. (Federal Register, title 40, Part 204, January 24, 1976), (GenRad Application Note AN-102)

A video output is provided to drive an external, large-screen video display. A camera adaptor is also available for taking pictures of the display on the instrument with a Polaroid® camera. The camera can also be used to take pictures of the noise source or its environment.

An optional output interface provides the necessary signals to drive x-y plotters and other graphic recorders for a permanent record of the spectrum. This option also allows control of the instrument through an IEEE-488 bus (ANSI MC1.1-1975, IEEE std 488-1975), which is available on many calculators. All keyboard functions can be programmed through the IEEE bus. In addition a reference spectrum can be transferred from the controller into the 1995 stored memory. The controlling calculator or computer can program the 1995 to transfer the spectral data at the end of a measurement cycle from the 1995 to the calculator or computer. Then the computer can process the data in any way desired.

9.3 FAST FOURIER TRANSFORM ANALYZERS.

As explained in Chapter 8, digital techniques of time-series analysis are providing another versatile approach to the study of acoustic and vibration signals. The GenRad 2512 Spectrum Analyzer, shown in Figure 9-5, is a push-button controlled analyzer of this type. It can provide great detail, because it separates the

spectrum into 400 bands, and the various stages in the process can be displayed on the video monitor (CRT). The selected signal can be viewed as a function of time, which makes it possible to ensure that the desired section will be transformed. The transformed signal is displayed as a spectrum with a linear or logarithmic frequency axis. The vertical axis can be a logarithmic dB scale, linear amplitude (pressure) scale or a pressure-squared scale.

Because of buffered operation and high speed processing, the 2512 can operate in real time to 20 kHz. This speed makes possible spectrum averaging many samples of noisy data in a short time. Rectangular and hanning weighting of the input data are also provided. A spectrum can be stored for later comparison with subsequently measured spectra.



Figure 9-5. A high speed spectrum analyzer that uses a fast Fourier transform to provide 400 lines of resolution.

The instrument has relatively few panel controls even though it has a wide range of choices for measurement parameters. The operator is led through these choices by selective displays, which simplify the setup procedure.

The 2512 is portable and thus it permits detailed analysis in the field. An option provides control of the instrument by a calculator or computer having an IEEE-488 bus.

Outputs are available for reproducing the displayed analysis on an x-y recorder.

Two-Channel Analyzers

When transfer functions, coherence functions, cross spectra, and auto and cross-correlation are required, a more sophisticated analyzer, such as the GenRad 2505, shown in Figure 9-6, is required. Even though it is exceptionally versatile, it has been designed to be relatively easy to use.

The transfer function can be used to monitor the structural condition of a machine. It can help in tracking down cracks and broken pieces, loosening of fastenings and the effects of wear. Here it is helpful to have a set of transfer functions for the machine when in good operating condition.

The transfer function can be particularly helpful in checking for resonant structures that are causing excessive noise or vibration. The nature of the resonant motion can be studied, and then the resonant behavior is more readily modified.



Figure 9-6. The GR 2505 Signal Analysis System for analysis of one or two-channel data by FFT processes.

9.4 CONTINUOUSLY ADJUSTABLE FILTER.

Sometimes reduction of system bandwidth can decrease the relative intensity of extraneous signals, for example hum, without affecting the important part of the signal to be studied, or the effect on the signal of limiting the bandwidth needs to be studied. Some vibration measurements require that high-frequency portions of the frequency spectrum be eliminated from the observation. Such applications are often handled by adding the 1952 Universal Filter, shown in Figure 9-7, to a system. It will perform as a continuously adjustable low-pass, high-pass, band-pass, or band-reject filter over the frequency range of 4 to 60,000 Hz (Kundert, 1968).

Controlled bands of noise can be generated by the use of this filter with a random-noise source. Such bands are often useful for psychoacoustic tests, room-acoustics tests, and vibration tests.

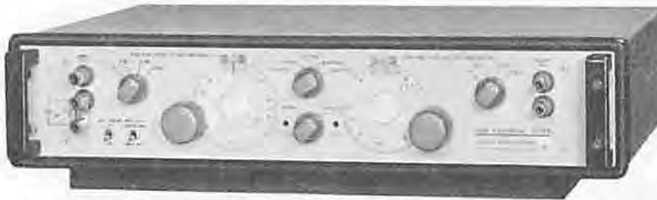

Figure 9-7. Type 1952 Universal Filter; at left are low-pass and high-pass filter characteristics.

REFERENCES

Standards

- ANSI S1.11-1966 Octave, Half-Octave, and Third-Octave Band Filter Sets
- ANSI MC 1.1-1975 (IEEE STD 488-1975) IEEE Standard Digital Interface for Programmable Instrumentation.
- IEC/225 (1966) Octave, Half-Octave, and Third-Octave Band Filters

Other

- W.R. Kundert (1968), "A Universal Filter for Low-Frequency Work," *General Radio Experimenter*, Vol 42, #4, April, pp. 14-19.
- W.R. Kundert and E.R. Marteney (1971), "A Modern Portable Sound Analysis System," 7th ICA, Budapest.
- GenRad Application Note AN-102, "Using the GR1995 for measuring the noise emissions of portable compressors," GenRad, Concord, Mass.

Chapter 10

Recorders and Other Instruments

10.1 GRAPHIC RECORDER.

Graphic recorders of various types are used to produce a permanent, reproducible record of the results of a measurement. As an accessory to sound and vibration instruments, they can be used to record over periods of time the sound level near highways, airports, residences, or the vibration levels of building floors or walls, bridges, or airframes and to measure reverberation time. The resulting information is much more extensive than that obtainable from a few readings of a meter, and when observations over a long period are desired, the recorder can be unattended.

Some recorders can be used with an analyzer to plot the frequency spectrum of a noise source or of a vibrating object. The combination of a recorder with a tunable oscillator and other accessories can produce records of the acoustic-transfer characteristics of rooms, walls, microphones and loudspeakers, the electrical response of analyzers, networks, and amplifiers, and the vibration transfer characteristics of shakers, vibration pickups, and structures.

The GR1985 DC Recorder, shown in Figure 10-1, is a portable, battery-powered strip chart recorder that is compatible with the 1933, 1981, 1982, and 1983 Sound-Level Meters and is used to produce permanent plots of the noise level with time. When used with these sound-level meters, it has a 50-dB recording range. It is therefore particularly valuable for environmental noise recording in the community or in industry.



Figure 10-1. Type 1985 DC Recorder.

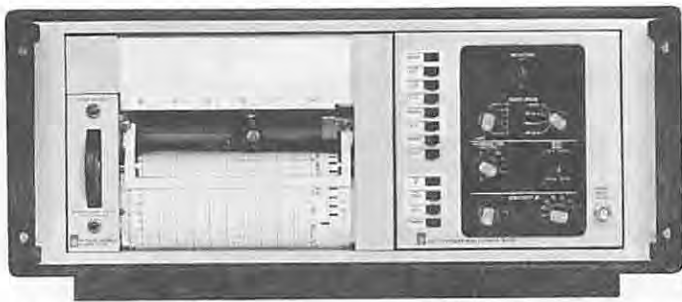

Figure 10-2. Type 1523 Graphic Level Recorder with -P1A preamplifier plug-in accessory at right.

The 1523 Level Recorder shown in Figure 10-2 is the basic element in a system to do many different operations. It is a servo-type strip-chart, pen recorder that uses a disposable cartridge. It has a wide range of speeds for the chart drive, of averaging times for the detector system, and of level ranges for recording. The maximum level range is 100 dB. Limit comparators are included for use in production test systems.

When this recorder is used with the appropriate plug-in, the -P1A, it forms a level-recorder system, and it can be used for the applications of recording as a function of time mentioned above. This plug-in amplifier includes an A-weighted response as well as a FLAT response. The A-weighted sound level versus time measurements are particularly important for community noise studies. A graphical record versus time permits one to relate noise complaints with specific noise events.

When the recorder is used with the 1523-P2 Sweep Oscillator plug-in and other accessories, it can record responses and transfer characteristics as a function of frequency.

This sweep oscillator covers the frequency range from 1 to 500,000 Hz and the upper and lower limits of the sweep can be selected independently. The time/10:1 frequency change can be maintained constant, or it can be set to decrease (increase speed) with increasing frequency. This decreasing sweep time is usually satisfactory for measurements on most physical systems, and it saves measurement time compared with maintaining the slow rate required for the low-frequency end of the range.

Another plug-in, the 1523-P4 wave analyzer, permits recording a narrow-band analysis of product noise or vibration, or signatures for preventive maintenance. The analysis is a swept heterodyne technique of the type described in paragraph 8.6.4 with filter bandwidth of 10 and 100 Hz. It covers the frequency range from 10 Hz to 80 kHz.

10.2 X-Y RECORDER.

An x-y recorder is designed to plot graphs with rectangular coordinates from electrical signals supplied to the recorder. These recorders are now widely used, particularly for plotting the results of measurements or of computations. The GR 1995 Integrating Real-Time Analyzer has an option that will provide the necessary signals to an x-y recorder to produce graphs of one-third octave analysis. Similarly the GR 2512 has an option for plotting on an x-y recorder the analysis obtained by that spectrum analyzer.

10.3 MAGNETIC-TAPE RECORDER.

The magnetic-tape recorder has become a useful tool for the acoustical engineer both in research and in development. It stores a signal as variations in the magnetic state of the particles on the tape. The time scale then becomes a length scale on the tape.

The signal to be stored must be supplied to the recorder as an electrical signal; and, for recording noise as a function of time, this electrical signal is usually obtained from a high-quality microphone. When measurements are to be made on the stored signal, the recorded tape is played back on the recorder and measurements are made on the electrical output signal.

The magnetic tape recorder is being used to perform the following functions in the field of noise measurements:

1. To keep reproducible records of progressive changes in a sound. These changes may be a result of the application of successive noise-control procedures, for example.
2. To record a noise for analysis by a number of techniques, when the particular approach to be used is not at first obvious and it is not convenient to use the original source repeatedly.
3. To record a noise in the field for detailed study in the laboratory, where more complex instrumentation systems can be used.
4. To record a sound that varies with time. Samples can then be selected from the recording for analysis to obtain the change in spectrum as a function of time.
5. To record a short-duration sound, which can then be played back repetitively to simplify analysis.
6. To monitor over long periods to catch intermittent sounds, which can then be separated for analysis.
7. To record noises that are erratic or intermittent, possibly by binaural techniques, to aid in tracking down sources.
8. To record a noise to permit a frequency translation for convenience in analysis.
9. To record a transient noise in order to change the time scale or to invert the time scale for ease of graphic recording.
10. To permit subjective or objective comparison among sounds recorded at different times. The subjective judgment can then be made by groups listening under similar conditions.
11. To permit observation of the subjective effects of altering a signal, for example, by filtering, clipping, or adding noise.
12. As a measurement system with a recorded signal as the source and a recording channel as the detector, for example, in the measurement of reverberation characteristics.

These applications have been stated for acoustical signals, but most of them apply to vibration signals as well.

10.4 RANDOM-NOISE GENERATORS.

The random-noise generators (Faran, 1968), shown in Figure 10-3, are sources of high-level, broad-band electrical noise, which can be converted to acoustic noise by means of an earphone or a power amplifier and a loudspeaker. Such acoustic noise is useful in psychoacoustic experiments, in the measurement of reverberation time and noise transmission, in loudspeaker- and microphone-response measurements, in microphone testing, and for calibration procedures.

The output of a random-noise generator can be filtered by one of the analyzers or by the 1952 Universal Filter (Figure 9-6) to provide a band of noise anywhere in the audio range. This type of signal is often preferred to the broadband-noise signal for the measurements mentioned above.

Figure 10-3. GenRad random noise generator; spectrum characteristics of output of 1381 shown (left) and 1382 (right).

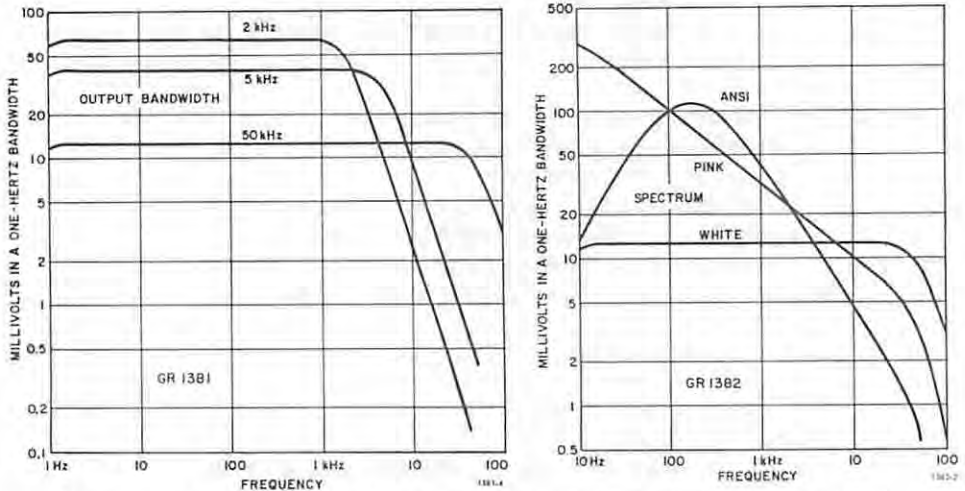

The output of a random-noise generator can also be converted to a random mechanical motion by an electromechanical shaker for mechanical testing of components and structures. The 1381 Random-Noise Generator is most suitable for this application because it includes electrical filtering to limit the bandwidth to 2, 5, and 50 kHz, and adjustable clipping of the noise signal limits the excursion of the electrical voltage. The 2 and 5-kHz bands are often used in vibration testing.

The 1382 Random-Noise Generator is more suitable for acoustic testing, since it provides white noise (constant-energy-per-hertz-bandwidth), pink noise (constant-energy-per-octave-bandwidth), and the noise specified in ANSI Standard S1.4-1961, paragraph 3.2.2. The pink noise is often preferred for tests with analyzers having a constant-percentage bandwidth, for example, octave or $\frac{1}{3}$ -octave. These different spectra are shown in Figure 10-3.

10.5 TONE-BURST GENERATOR.

The combination of an oscillator and a tone-burst generator (Skilling, 1968) is a source of electrical tone-burst waveforms that can be converted to acoustical tone bursts by means of an earphone or a power amplifier and loudspeaker. Such an acoustical signal is useful in room-acoustic measurements, in psychoacoustic experiments, in studies on transducers and acoustical material properties, and in amplifier tests. It is particularly helpful in locating stray reflections in anechoic chambers and in tracing sound-transmission paths.



Figure 10-4. Tone-burst pattern from 1396-B Tone Burst Generator. Input, 3 kHz; 16 cycles on; 16 cycles off.

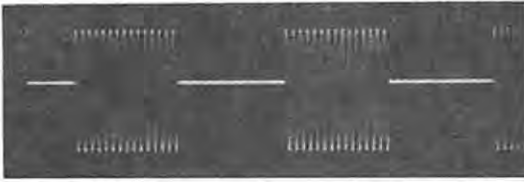

The 1396-B Tone-Burst Generator, shown in Figure 10-4, produces an abrupt on-off transition and is particularly useful for measurements of physical systems. The on and off times can be set in terms of the numbers of cycles of the input wave or a separate wave or in terms of time.

The G/S Model 929E Electronic Switch and Model 471 Interval Timer in combination constitute a flexible means of controlling an audio signal, including an abrupt tone burst or one with rise and decay times of 1 to 500 msec. The signal, with a gradual rise and decay time, is more suitable for psychoacoustic testing than one that is abrupt.

10.6 AUTOMATIC-LEVEL REGULATOR.

In the testing of response or transmission-loss characteristics in room and building acoustics, it is often helpful to control or regulate the level of the test signal to keep it constant. The 1569 Automatic Level Regulator (Kundert and Woodward, 1968), shown in Figure 10-5, is an important element in such a system. It can, for example, reduce a level variation of 25 dB to a variation of only 1 dB, when it is supplied with the proper reference signal and it is inserted as part of the signal-supply loop. Such large initial variations can occur because of the marked frequency irregularity of rooms and many loudspeakers.



Figure 10-5. Type 1569 Automatic Level Regulator.

10.7 OSCILLOSCOPE.

A cathode-ray oscilloscope is a useful means of observing the waveform of a sound or vibration signal from a sound-level meter or a vibration meter. It can be used to measure the peak amplitude of a wave and, after some experience, the observer can, by adjusting the sweep frequency, tell something about frequency components by looking at the wave. In addition, the oscilloscope makes possible the study of the instantaneous values of a vibration motion. In contrast to the vibration analyzer and other wave analyzers that present information in terms of frequency, the oscilloscope presents information as a function of time. This representation is often of great assistance in the solution of vibration problems. Because the oscilloscope presents information instantly and continuously, and because its frequency response is not a limiting factor, it is useful in the study of any vibration waveform.

For sound and vibration measurements an oscilloscope with slow sweep rates, long-persistence screen, and dc amplifier is recommended. Many oscilloscopes have provision for the addition of a camera, which makes possible a permanent record of the wave shape being studied.

10.8 VIBRATION SHAKERS.

Several types of vibration shakers are widely used. One of the most versatile is the electrodynamic shaker. These shakers, produced in a wide range of sizes, are used by environmental test engineers in many ways to help evaluate performance of instruments, components, and structures. Typical uses are: endurance or fatigue testing of electrical and mechanical structures, testing of resilient or shock mounts, shake testing of electrical components such as switches, relays, or amplifiers, determination of damping characteristics of materials, and calibration of vibration pickups.

Some tests use sinewave excitation, with the frequency either set to a resonance of the device under test or swept over a specified band. Other tests use shock waveform excitation where either a specific transient signal is required at the control point of the device under test or a specified shock response spectrum (Kelly and Richman, 1969) is required.

The most widely accepted type of vibration testing uses random excitation. In digital systems the random signal is usually computed by taking the inverse Fourier transform of a shaped noise spectrum with random phase angle.

Since the motion of the shaker is affected by the structure fastened to it, the drive system cannot always be readily preset to produce a required motion of the device being tested. The motion at the fastening points of the device may be monitored with vibration pickups and analyzed to check the spectrum. This information can then be used to set the shaker drive signal to the proper spectrum shape and level. The ultimate approach is to arrange the system to monitor and control the level automatically. (Chapman et al., 1969; Heizman and Sloane, 1972; Sloane, 1972; Heizman, 1973). This approach is used in the random vibration control system shown in Figure 10-6.

SIMPLIFIED FUNCTIONAL SYSTEM CONFIGURATION

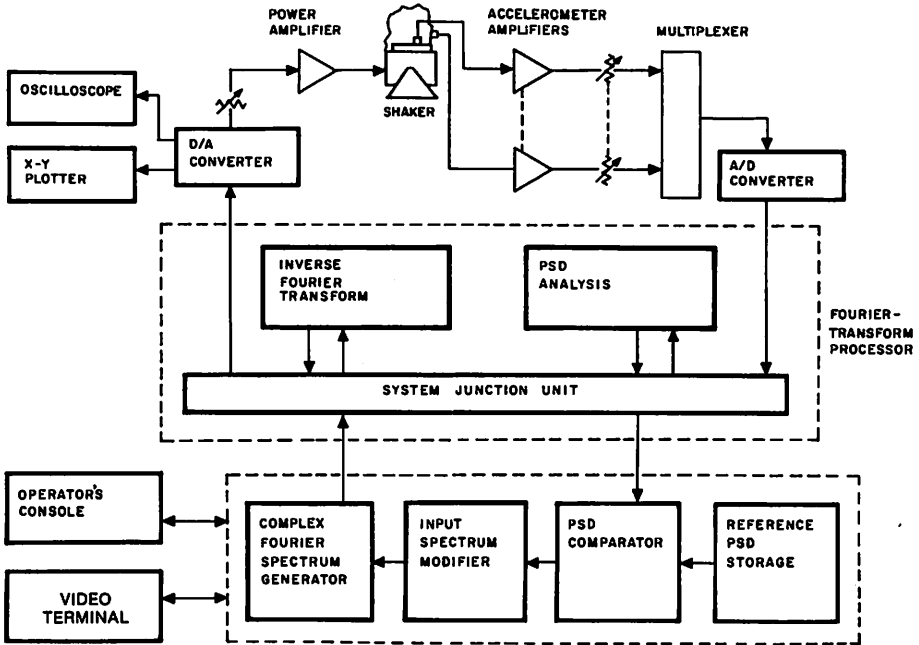

1923-34

Figure 10-6. Random vibration control system functional diagram.

GenRad 2503 and 2506 Digital control Systems are of this type. They are available for random and sine-wave vibration and shock synthesis.

10.9 STROBOSCOPES.

The stroboscope is valuable in many vibration studies and therefore in noise control work, because it permits rotating or reciprocating objects to be viewed intermittently and produces the optical effect of slowing down or stopping motion. For instance, an electric fan revolving at 1800 rpm will apparently stand still, if viewed under a light that flashes uniformly 1800 times per minute. At 1799 flashes per minute the fan will appear to rotate at 1 rpm, and at 1801 flashes per minute it will appear to rotate backwards at 1 rpm.

Because the eye retains images for an appreciable fraction of a second, no flicker is seen except at very low speeds. The apparent slow motion is an exact replica of the higher-speed motion, so that the motion of the high-speed machine can be analyzed with the stroboscope under normal operating conditions.

This type of instrument can be used to measure the speeds at which vibrations occur in most rotating or reciprocating machines. Displacements in vibrating parts can often be measured accurately with the aid of a microscope, if a fine reference line is scribed on the part. This technique has been used to confirm the calibration of vibration calibrators, and automotive engineers have used it to measure crankshaft whip and vibration.

10.9.1 Strobotac® Electronic Stroboscope. The Strobotac® electronic stroboscope, shown in Figure 10-7, is a small, portable stroboscope calibrated to read directly in revolutions per minute. The light source is a strobotron tube, mounted in a parabolic reflector. The frequency of an internal electronic pulse generator determines the flashing speed, which can be adjusted by means of a dial. Normal flashing range for the GR 1546 Strobotac® Digital Stroboscope shown is from 100 to 25000 per minute, and the flashing rate is displayed on a light emitting diode (LED) readout.



Figure 10-7. Type 1546 Strobotac® Digital Stroboscope.

Other Strobotac® models come in different packages with different characteristics to suit a variety of applications. One model of the Strobotac® is available for flashing rates up to 150,000 per minute, and that model can be operated from a rechargeable battery. Speeds above and below this range can be measured by use of flashing rates that are simple multiples or submultiples of the speed to be measured. As the flashing rate of the Strobotac is decreased below 600 per minute, the flicker becomes pronounced due to the inability of the human eye to retain successive images long enough to give the illusion of continuous motion.

Of especial use in vibration measurements is the provision for connecting an external synchronizing signal to some models of the Strobotac®. Thus the light flashes can be triggered directly by a 1536-A Photoelectric Pickoff, which uses a photocell to synchronize the stroboscope with repetitive mechanical motion. It requires no attachment to the device being observed, and thus can be used effectively with low-torque devices. The output of the photoelectric pickoff requires amplification to trigger the stroboscope; this is provided by the Type 1521-P2 Flash Delay Unit, which also permits observation of the vibration at any point in its cycle.

The stroboscope can also be flashed by the output from a vibration pickup used with a sound-level meter to send triggering impulses to the stroboscope. Filtering is necessary between the measuring instrument and the stroboscope. An octave-band or a narrow-band analyzer can be used for such filtering.

10.9.2 Strobolume. The 1540 Strobolume® electronic stroboscope provides a very bright light over a large area (Miller, 1969). The maximum beam width is $40^\circ \times 65^\circ$. It can be controlled by an accurate oscillator for the range of 110 to 25,000 flashes per minute, by an oscillator/delay unit, or by a control unit to respond to external signals. The light output and versatility of the 1540 make it well suited for TV applications, such as video recordings of rapidly-moving parts in mechanical devices.

10.9.3 Motion Analysis Set. The Type 1539-Z Motion Analysis and Photography set is arranged for visual analysis of a repetitive motion or inspection of a process where the independent flashing-rate setting of the Strobotac is not required and for high-speed photography with conventional cameras. The major application areas for the motion analysis are in machinery and metal working, including packaging, printing, textile, earthmoving machinery, metal products, shipbuilding, automotive manufacturing, ordnance, chemical processing and aerospace.

10.9.4 Stroboscopic Applications. Stroboscopic techniques are widely used for visual observation of vibration. The high-speed performance of fans, propellers, and other rotating devices can be studied by means of the slow-motion effect of the stroboscope, and sources of vibration and noise due to misadjustments, misalignment, and wear can be readily detected. The vibratory modes of turbine blades are checked as they are driven electromagnetically, and the mode shapes are observed with the aid of an optical magnifier under stroboscopic illumination. Similarly, the flapping of the blades of a model helicopter rotor has been observed in slow motion by stroboscopic illumination.



Figure 10-8. Combination of instrumentation forces to solve a vibration problem. Shown are the Types 1538 and 1539 Stroboscopes to study the motion of parts on an electronic assembly being exercised on a shake table.

The stroboscope can also be used to observe the motion of apparatus being tested on a shaker, as in Figure 10-8. If the flashing rate is just slightly offset from the frequency of the shaker, a slow-motion replica of the high-speed vibration will result, so that the displacement can readily be observed. The form of the motion can be seen, and one can often tell what section needs to be strengthened and how damping material and damping devices can best be applied.

When a rotating or reciprocating machine is brought up to speed or is a variable-speed device, there may be resonant vibration modes of various parts at certain speeds, known as critical speeds. If these parts are visible and can be illuminated by a stroboscope, it is often possible to use the slow-motion feature to check on the actual behavior of the part at resonance. One can see if it is a fun-

damental resonance or a multiple resonance with various sections going in phase and others in phase opposition. This type of observation can be of great assistance in the determination of the proper treatment to reduce the resonant vibration.

TV cameras and receivers and video recording techniques offer a greater degree of flexibility in the use of stroboscopic techniques, particularly for remote observation.

Photographic recording of the stroboscopically illuminated motion makes possible accurate measurements of the motion. The accurately timed, very-short-duration light flashes provide the time scale and the almost instantaneous sampling of the motion.

For further details on the stroboscope and its uses consult F.T. Van Veen, *Handbook of Stroboscopy*, GenRad Inc., Concord, Mass., 1977, and Charles E. Miller, *Handbook of High-Speed Photography*, GenRad Inc., Concord, Mass.

REFERENCES

- G.B. Booth (1963), "Vibration Generation," Chapter 9 in Crandall, 1963.
- C.P. Chapman, J. Shipley, and C.L. Heizman (1969), "A Digitally Controlled Vibration or Acoustics Testing System," Parts I, II and III, Institute of Environmental Sciences, 1969 Proceedings, pp 387-409.
- S.H. Crandall, ed. (1963), *Random Vibration*, Vol. 2, The MIT Press, Cambridge, Mass.
- J.J. Faran, Jr. (1968), "Random Noise Generators," *General Radio Experimenter*, Vol 42, #1, Jan, pp. 3-14.
- C.L. Heizman and E.A. Sloane (1972), "Evolution of Digital Vibration Systems," Society of Automotive Engineers, #720820, October 25, 1972.
- M.C. Holtje (1966), "Flash — A New Strobotac Electronic Stroboscope," *General Radio Experimenter*, Vol 40, #4, April, pp 3-9.
- R.D. Kelly and G. Richman (1969), *Principles and Techniques of Shock Data Analysis*, The Shock and Vibration Information Center, Naval Research Laboratory, Washington, D.C.
- W.R. Kundert and C.A. Woodward (1968), "A Versatile Level Regulator for Swept-Frequency Sound and Vibration Testing," *General Radio Experimenter*, Vol 42, #4, April, pp 10-13.
- C.E. Miller (1969), "Detailed Viewing in Ambient Brightness," *General Radio Experimenter*, Vol 4, #9/10, September/October, pp 3-6.
- C.E. Miller (1970), "Using Stroboscopy," *Machine Design*, Vol 42, 30 April 1970, 14 May 1970. (two parts)
- J.K. Skilling (1968), "Redesigned Tone-Burst Generator Has Customer-Suggested Features," *General Radio Experimenter*, Vol 42, #10, Oct, pp 14f.
- E.A. Sloane (1972), "Optimum Random Vibration Control Using Transfer Function Analysis," Institute of Environmental Sciences, 1972 Proceedings.
- F.T. Van Veen (1977), *Handbook of Stroboscopy*, General Radio Company, Concord, Mass.

Chapter 11

What Noise and Vibration Measurements Should be Made

11.1 INTRODUCTION.

A wide variety of noise and vibration measurements can be made. They range from a simple measurement of sound level to a detailed vibration analysis showing hundreds of components of a complex vibration. Confronted with so many possible choices, one might well ask, "What measurements should we make, and what instruments do we need for our job?"

The answer to this question depends of course on what the job is. If the problem is one of checking compliance with a certain noise or vibration specification, the specification is usually set up so that the particular measurement required is reasonably clear and only some guidance as to choice of instruments and their use is needed. But if we are trying to reduce the noise produced by an appliance, the situation is more complex and extensive discussion is necessary.

In all these applications careful attention to the acoustic environment is essential. That is, if the background noise is serious or if reflected sound is significant, a penalty may result because the measured noise is higher than it would be under ideal conditions. These problems are discussed in the next two chapters.

In order to organize the possible answers to the basic question in a manner that will make the information readily usable, this chapter is arranged on the basis of the application. The next step is to find the field that fits the job in the following list and then to look up the referenced section.

- Devices that are Noisy or Vibrate Excessively (11.2)**
 - Product Noise and Test Codes (11.2.1)**
 - Production-Line Testing (11.2.2)**
 - Product Noise and Vibration Reduction (11.2.3)**
 - Machinery Preventive and Predictive Maintenance (11.2.4)**

Environmental Noise (11.3)

Hearing Damage Risk from Noise Exposure (11.3.1)

Community Noise (11.4)

Local Noise Ordinances (11.4.1)

Motor Vehicle Noise (11.4.2)

Powered Equipment Used Outdoors (11.4.3)

Airport Noise (11.4.4)

Site Selection (11.4.5)

11.2 DEVICES THAT ARE NOISY OR VIBRATE EXCESSIVELY.

11.2.1 Product Noise and Test Codes. Specifications of acceptable noise limits for products are becoming relatively common. These specifications are usually given as maximum sound levels or maximum octave-band levels or sometimes third-octave band levels at certain measuring points. Some specifications also include the measurement of radiated acoustic power.

Various engineering groups and trade associations have standardized test codes for measuring the noise from certain devices, for example, transformers, cooling towers, electric motors, fans and blowers, etc. These codes are often referenced as a part of a specification in order to standardize the measurement procedure to be used in checking for compliance to a maximum noise requirement. A representative list of test codes is given in the standards section of the Appendix.

A-Weighted Sound Levels. A simple example of noise testing is the check for compliance by a manufacturer for a customer who requires that the A-weighted sound level at 3 feet from any major surface of a motor be less than say 55 dB. He may also specify that the motor be mounted on a hard reflecting surface in an essentially anechoic space. Here, the A-weighted sound level needs to be measured and a sound-level meter with a microphone will do the job.

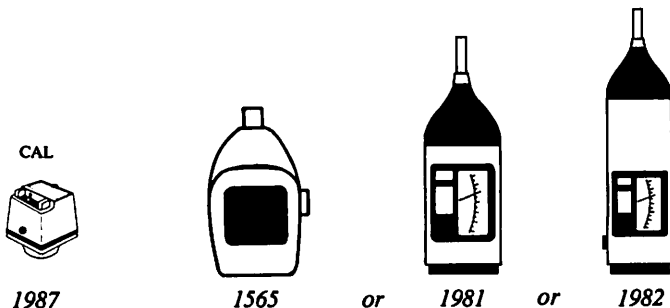

Figure 11-1. System to measure "A"-weighted sound levels.

The 1565-B Sound-Level Meter may be adequate for this test, and it is generally wise to include a Sound-level calibrator as part of the measurement system. If measurements below 40 dB may be required, the 1565-D Sound Level Meter should be substituted.

In many instances, however, it can be worthwhile to use a 1981-B or 1982 Precision Sound-Level Meter even for this simple measurement, because of the improved accuracy of the A-weighted measurement.

Analysis. Some customers may specify the maximum allowable octave-band levels under certain measurement conditions. The 1982 or 1933 Precision Sound Level Meter and Analyzer is the appropriate instrument to use, because it provides the octave-band analysis at high accuracy and a wide range of sensitivity levels.

Again, a calibrator should be included as a check on the accuracy of the measurement.

For estimates of probable customer reaction to the noise of a product, an A-weighted level or a third-octave-band analysis of the noise is the most widely used measurement. The band levels are used to calculate loudness level or perceived noise level. If competitors' products are measured in the same way, either procedure should permit one to rank the units in order of acceptability with good reliability.

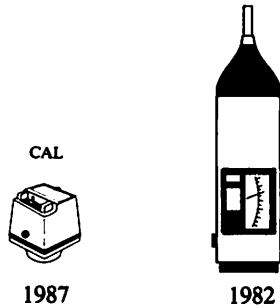

Figure 11-2. Octave-Band Analysis.

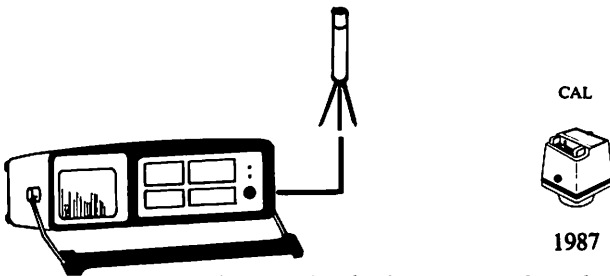

Figure 11-3. Third-Octave-Band Analyzer.

Acoustic Power Output. The use of acoustic power output for rating noisy devices is widely recognized as the best approach for certain measurements. Acoustic power is calculated from the results of a number of sound-pressure level measurements, usually octave or $\frac{1}{3}$ -octave-band levels. The procedure requires a controlled environment, usually an anechoic room, a reflecting floor in an anechoic room, or a reverberation room. Under certain conditions the requirements on the environment may be relaxed. The instrumentation used here covers a wide range.

For example: It can be a microphone that is moved from place to place and analyzed with a 1995 Real-Time Analyzer. If the calculation of directivity factor or other data reduction is required, a calculator controller may be connected to the 1995 through the optional IEEE Interface. Calculated results can be printed out. In place of a microphone moved manually, it can be a moving microphone that scans a given area as its output is analyzed on a 1995 Real Time Analyzer, with the averaged output plotted on an x-y recorder. It can be a 1982 Precision Sound Level Meter and Analyzer with its microphone on a tripod. An analysis at each of a number of microphone positions is made. Here, the results are recorded and calculated by hand.

If an acoustic power measurement is to be made in a reverberation room, it is essential to know the total sound absorption in the room. That is measured indirectly by noting how fast sound decays in the room. The decay rate is measured by exciting the room with an octave or third-octave band of noise. The sound level is recorded by use of a microphone pickup, amplifier, filter and graphic recorder. The source of noise is suddenly turned off and the decay of sound is recorded. The average slope in dB/sec of the recorded decaying sound is the decay rate. The slope is usually measured starting at least 5 dB down from the beginning of the decay and over a range of at least 30 dB. Details of the measurement are given in ASTM Method of Test for Sound Absorption and Sound Absorption Coefficient by the Reverberation Room Method (ASTM C423-77).

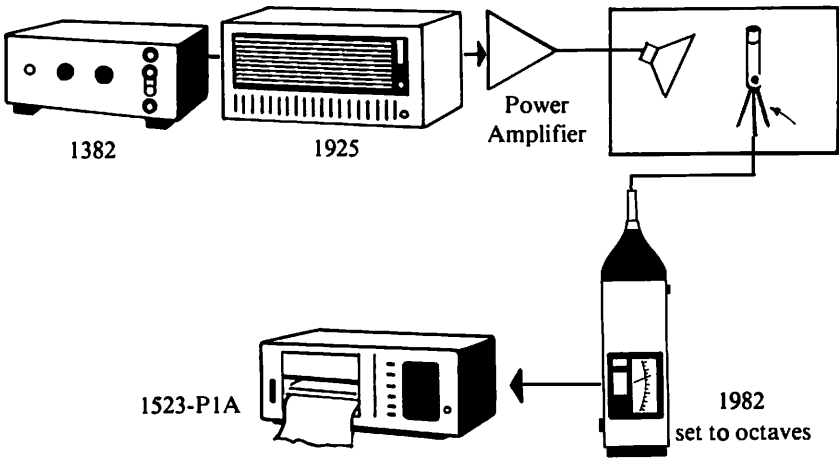

Figure 11-4. Decay rate and reverberation time measurements.

The reverberation time is more commonly used as a measure of this room characteristic, and it is simply 60 dB divided by the decay rate. It refers to the time required for the sound to decay by 60 dB.

Product Noise and Test Codes. In order to be more specific, some examples of instrumentation for certain test codes will be given.

The American Society of Heating, Refrigerating, and Air-Conditioning Engineers (ASHRAE) has prepared a set of standards* for measuring the noise radiated by heating, refrigerating, and air-conditioning equipment. These standards are used by the Air-Conditioning and Refrigeration Institute (ARI) to obtain the basic data in their standards for rating the equipment.

The preferred basic instrument for this use is the 1995 Real-Time Analyzer. It provides the highly selective third-octave filters and the long averaging times required by the standards.

*See Appendix VII for list of standards and codes.

An appropriate microphone setup for this measurement could be a single microphone that is moved manually from place to place or a microphone that moves continuously over a long path as the sound-pressure squared is integrated in the 1995.

The Compressed Air and Gas Institute (CAGI) and the European Committee of Manufacturers of Compressed Air Equipment (PNEUROPE) have prepared a "CAGI-PNEUROPE Test Code for the Measurement of Sound from Pneumatic Equipment," ANSI S5.1-1971. It specifies procedures and operating conditions for the equipment, and it requires octave-band analysis of the noise at a number of points near the equipment.

A precision sound-level meter and a calibrator are required, and the observer and measuring instrument are to be at least one meter away from the microphone. These requirements lead to the use of 1982 or 1933 Precision Sound-Level Meter and Analyzer with 10 feet of cable, a tripod, and a sound-level calibrator, which are all a part of a sound analysis system.

If the measurements are to be part of a production test, various degrees of sophistication can be used in the instrumentation, procedures, and setup to speed up the measurement. Since 5 or 10 measurement locations are specified, fixed supports and microphones at each location could be used. These could connect into the 1566 Multichannel Amplifier, which can scan the outputs of the microphones manually or automatically. The octave-band analysis could be done with a 1995 Real-Time Analyzer, with the measured equipment noise levels and background noise levels plotted on an x-y recorder.

The noise-certification tests for aircraft, as prescribed in Part 36 of the Regulations of the Federal Aviation Administration (FAA, 1969) require extensive instrumentation and calculations. The noise at a number of points must be recorded on magnetic tape, during specified landing and takeoff procedures. The recording must also include a calibration signal. The response characteristics of the recorder must be exceptionally good, since they must meet the requirements of IEC-R179 (Precision Sound Level Meters).

The recorded noise is then analyzed every half second, into $\frac{1}{3}$ -octave bands, by a 1995 Real Time Analyzer. These band levels are processed successively by an associated small computer. Each 0.5 second set is stored in the computer. The levels are corrected for the calibration results and the effective perceived noise level is calculated. This result is then corrected for departures from the standard flight path and standard atmospheric conditions.

The standard prepared by the Institute of Electrical and Electronic Engineers for Airborne Noise Measurements on Rotating Electric Machinery, IEEE No. 85, covers a variety of measurement procedures. These include sound-level measurements and sound analysis in octave or third-octave bands, at a point or at a number of points in the vicinity of the machinery. When the sound-power level is required, it is calculated from the band levels measured at certain specified points.

For sound-level and octave-band level measurements, a 1982 or 1933 Precision Sound-Level Meter and Analyzer would be preferred. It can be automated by the use of a 1995 Real Time Analyzer and an x-y recorder to plot the results of the analysis.

If $\frac{1}{3}$ -octave analyses are desired, the convenient combination of a 1995 Integrating Real Time Analyzer and an x-y recorder (or a Polaroid® Reporter Camera) is suggested.

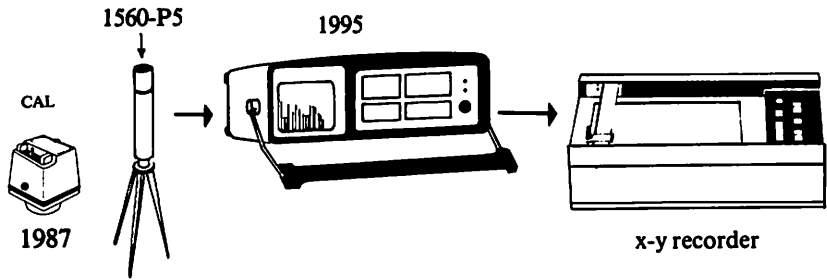

Figure 11-5. Production-line testing instrumentation.

11.2.2 Production-Line Testing. Ideally, many devices should be tested for noise output on the production line. Noise measurements on the production line are often possible, but hardly ever in an ideal manner. That is, precision acoustical testing usually requires a large, isolated, echo-free space, which would not ordinarily be considered for inclusion as part of a production line. Nevertheless, useful noise measurements can often be made with relatively simple procedures, although the accuracy of rating may be significantly reduced compared with that possible with an ideal measurement.

In this discussion we shall consider briefly several possible solutions to this problem, ranging from the elaborate to the simple. For some expensive devices where the noise level is exceptionally important, for example, large power transformers, the required very large, isolated, echo-free chambers have been used to test each unit as it is produced. When the device is not so large and low frequencies are not important, a reasonable-size anechoic chamber with refrigerator type doors can be used.

Although the acoustic environment is an important consideration for all the noise measurements discussed in this chapter, the requirements of production testing make the control of the environment a more difficult problem than it is in a research and development laboratory.

A massive, tight, resiliently mounted enclosure is necessary to avoid pickup of ambient stray noise that will affect the measurement. For the same reason the access door must be one that seals exceptionally well. Then, in order to get the required echo-free behavior, extensive treatment of the inside is necessary.*

An enclosure with hard walls can also be used in some instances. Here the design should be such as to make it a reverberation room.

A simple approach is sometimes satisfactory for production line screening of noisy devices. This approach depends on measurements of the sound at a number of points very close to the device. The points selected should be determined by exploration of the behavior of some acceptable and some noisy samples of the device. A scan of the sound field near the major surfaces of the device along with a study of the octave-band or third-octave band spectrum should show which are the critical bands and locations for rating the noise. Some isolation of the device on the production line may be necessary in order to avoid interference from adjacent units or from the noise of production machinery.

Sometimes a series of vibration measurements can be used for production line tests. This approach usually requires a study of the vibration patterns of the various surfaces of the device in order to find the critical areas. Usually, the major surfaces should be tried first. In production, the tests should be made with the device resting on a very thick, resilient pad or mounted on soft mounts that help isolate against ambient vibration.

*Anechoic chambers of various sizes are manufactured by, for example, the Eckel Corporation, 155 Fawcett Street, Cambridge, Mass.

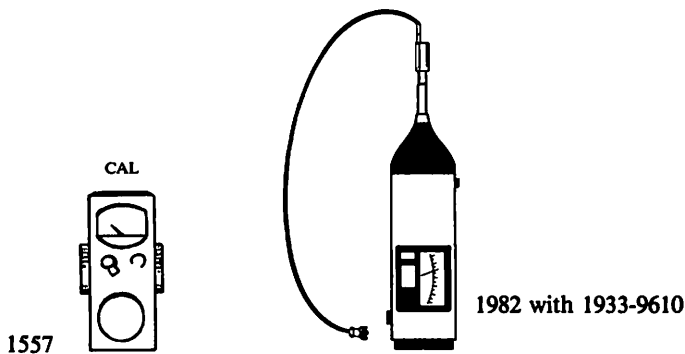

Figure 11-6. Alternate production-line testing instrumentation.

The high-speed $\frac{1}{3}$ -octave analysis that is possible with the 1995 Real Time Analyzer makes it particularly suitable for production testing. When it is used with the camera adaptor and Polaroid® camera or with an x-y recorder, one can have a permanent record of the noise analysis.

The 1995 Real-Time Analyzer can be made a part of a calculator-controlled system that is exceptionally versatile. It can compare the measured spectra with stored spectra or criteria, to determine the acceptability of the device under test. It can transform the spectra into calculated loudness, or perceived noise level, or the ARI 270 Sound Rating, and print out the calculated result. It can print out certain stored messages that depend on the value measured. It can have a set of operator-controlled programs for different tasks.

The 2512 Spectrum Analyzer can provide even more flexibility because of the detailed analysis that is possible over a wide range of audio frequencies.

11.2.3 Product Noise and Vibration Reduction. In a program for the reduction of noise and vibration, the modern real-time analyzers are key instruments. When used with graphic recorders they can provide a record of the results of successive noise- and vibration control measures.

Some sounds vary significantly in level and character with time. Appliances that go through a cycle of different operations produce such sounds. High-speed analyzers, such as the 1995 Integrating Real-Time Analyzer and the 2512 Spectrum Analyzer permit a detailed analysis during each phase of the cycle. Similarly for devices, for example a gas engine, that drift in speed, as they drift in speed, the basic noise pattern can change. But for the short interval required for a real-time analyzer to get useful results, the inertia of the system is often adequate to give stability to the measurement.

The full range of analysis equipment is helpful in the product-development phase. The detailed analyses and the wide variety of techniques available make FFT analyzers invaluable in tracking down the cause and sources of troublesome components of the noise. Other analyzers provide varying degrees of detail in the analysis, and often one can select the one that is most suitable for a particular job from among the 1982, 1933, 1995, and 2512.

For any of these studies, the 1982 or 1933 Precision Sound Level Meter and Analyzer is helpful for making the basic reference measurements of overall level, A-weighted level, and even octave-band analysis for checks on ratings as the noise-control procedures are instituted. It also provides the impulse mode for measuring noise from typewriters, trippers, chain drives, riveters, and the like.

If vibration reduction is the prime goal, vibration pickups should, of course, be used to supply the signals to the analyzers. But even if noise reduction is the desired goal, the reduction is often accomplished by reducing the vibration of various parts of the device. Here vibration pickups should be used, or the motion should be studied with stroboscopic observation of the moving parts. This procedure is described in Chapter 15.

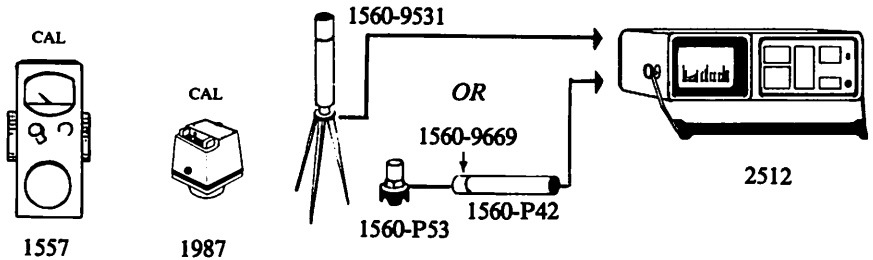

Figure 11-7. Narrow-band sound or vibration analysis.

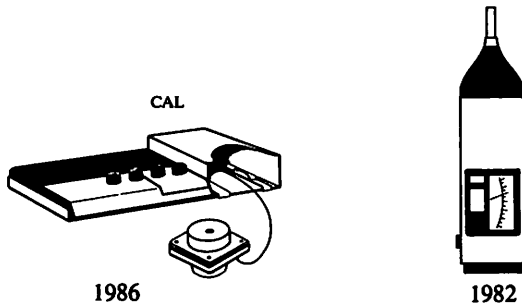

Figure 11-8. Impact-noise analysis in octave bands.

11.2.4 Machinery Preventive Maintenance (Predictive Maintenance). Only one aspect of machinery maintenance is considered here, namely, the relation of the vibration or noise output of a machine to its condition. That is, vibration or noise measurements can guide in predicting incipient failure of a machine, in deciding when cleaning, parts replacements, and other maintenance procedures are necessary, and in determining the relation between vibration and the performance of the machine.

Preventive maintenance has many advantages (Wyder, 1977). Some of them are:

1. Less production downtime, because of fewer breakdowns.
2. Fewer large-scale repairs and fewer repetitive repairs.
3. Identification of low reliability equipment, with possible correction of faulty construction and design, misapplication, operator abuse, and obsolescence.
4. Lower manufacturing costs.
5. Fewer product rejects, less spoilage, better quality control, because of properly adjusted equipment.
6. Less standby equipment needed.
7. Less hazardous working conditions.
8. Increased life and reliability of equipment.

One basic technique in this form of preventive maintenance is to compile a history of the analyzed vibration levels for three directions at each bearing housing. When the levels change noticeably, the situation is reviewed to see if it is reasonable or if it is likely that deterioration of some structure has occurred. It can then be used as one guide in deciding when and how machinery is to be overhauled. Octave-band analyses have been found helpful here (Glew and Watson, 1971), but $\frac{1}{3}$ -octave analyses are also used (Bowen and Graham, 1967).

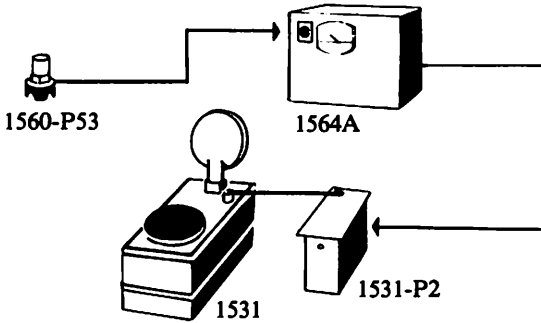

Figure 11-9. Tenth octave-band vibration analysis with stroboscopic observation.

When many machines are being monitored, so that many analyses need to be made and recorded, the combination of a 1995 Integrating Real Time Analyzer and the camera option provides a rapid way of producing the data to be studied for maintenance procedures.

Fine detail of analysis may be helpful in investigating certain faults of rotating machinery, and the narrower-band analyzers, for example, the 2512 Spectrum Analyzer, are then appropriate instruments to use. These FFT Analyzers also provide waveform averaging (summation analysis) in addition to narrow-band analysis, a useful investigational tool in machinery maintenance (see paragraph 8.4.5).

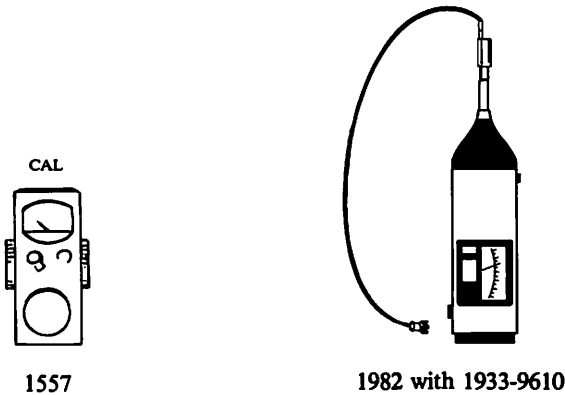

Figure 11-10. Velocity measurement and analysis system.

One common source of trouble in machinery is rotational unbalance. A variety of instruments and techniques are used for balancing. If a 2512 Spectrum Analyzer is available, it can be used with a vibration pickup to do balancing (Plummer et al., 1978).

11.3 ENVIRONMENTAL NOISE.

11.3.1 Hearing Damage Risk from Noise Exposure. As described in Chapter 3, the noise near some machines is intense enough to cause permanent hearing damage, if the exposure continues for long periods. As explained, the main technique for checking potentially dangerous areas is to measure the noise exposure with a 1954 personal noise dosimeter or with a standard sound-level meter. If the sound is impulsive, the sound-level reading should include a peak reading taken on a 1982 or 1933 Precision Sound-Level Meter and Analyzer.

The most convenient and satisfactory measurement of the noise exposure is done with a 1954 Noise Dosimeter, which combines the observed levels according to the current regulations, so that calculations are not required.

These measurement procedures are the ones currently used under the regulations of the Williams-Steiger Occupational Safety and Health Act of 1970 (OSHA, 1971), the Walsh-Healey Public Contracts Act, as amended, and the Federal Coal Mine Health and Safety Act of 1969.

As pointed out in Chapter 3, if potentially hazardous noise exists in a plant, audiometric examinations of exposed personnel and work to control the noise are necessary. The audiometric examinations can be contracted out, or with the use of an Audiometer, they can be done at the plant, as described in Chapter 3. Other instrumentation is useful in noise control, which is discussed in Chapter 16 and Section 11.2.

11.4 COMMUNITY NOISE.

11.4.1 Local Noise Ordinances — Area Noise. Some cities and towns regulate the maximum noise levels permitted at lot boundaries, with the limits set according to the district. Most of these ordinances now use the A-weighted sound level measured on a sound-level meter although some specify octave-band levels.

In the 1971 Chicago Noise Ordinance, for example, the noise level in business and commercial districts at the lot boundary is not to exceed 62 dB(A). In residential areas, the noise level coming from a residence is not to exceed 55 dB (A) at the lot boundary. In manufacturing districts the noise is measured at the district boundaries and the limits range from 55 to 66 dB (A).

The sound-level meter should be used with a windscreen for this monitoring. Since the operations in a factory can vary considerably during the day and night cycle, some plants may require monitoring with a recorder on the output of a sound-level meter for long periods of time. A 1982 or 1933 Precision Sound Level Meter and Analyzer and a 1985 Recorder can be used.

The extensive use of air-conditioning units, particularly those with outdoor heat exchangers, has made noise monitoring more important in residential areas. Air conditioners can be particularly bothersome at night when some wish to have their bedroom windows open, and monitoring the noise on a hot night is particularly appropriate.

A-weighted day-night sound level (L_{dn}) or equivalent sound level (L_{eq}) is being extensively used now to rate community noise (see paragraphs 4.12, 4.13, and Chapter 14). The GR 1945 Community Noise Analyzer with the L_{eq}/L_{dn} option is the most suitable instrument for these measurements.

11.4.2 Motor-Vehicle Noise. Some states and some cities and towns in the USA and many other countries have ordinances or laws that set permissible limits on noise from motor vehicles. These are also generally specified in terms of the A-weighted sound level at some distance from the vehicle. Chicago sets limits on the vehicles as sold, as well as in operation.

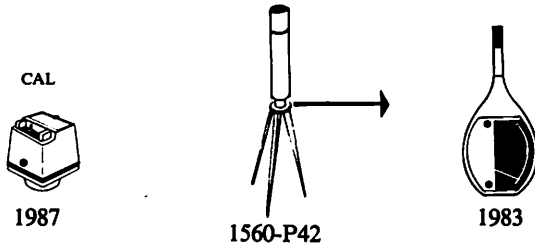

Figure 11-11. Measurement Set for Vehicle Noise Measurement.

11.4.3 Powered Equipment Used Outdoors. Much construction and industrial equipment is used outdoors, and many power tools, power lawnmowers, riding tractors, etc. are used in residential areas. These are also being regulated in an attempt to reduce the noise nuisance, again mainly by the specification of maximum A-weighted sound levels.

11.4.4 Airport Noise. Noise of busy airports is of great concern to those living nearby. In some areas vigorous community action has resulted, and much effort is now being devoted to studies of how to control and reduce this noise impact. Some airports have extensive noise-monitoring systems. By imposing maximum limits on the noise level permitted for the aircraft that use the airport, the airport operator can bring the noise problem under better control. By gradually lowering those limits as quieter aircraft are developed, he can effect further improvements.

California is requiring noise monitoring with maximum noise level limits for all airports that have a noise problem. A-weighted sound levels, as determined with the slow dynamic characteristic, are used. The A-weighted levels are summed over time on an energy basis to obtain a noise-exposure level (NEL), referenced to 20 μ Pa and one-second duration. This noise-exposure level is used in different ways to obtain limits on the allowable levels, either as a single event or as a daily community noise equivalent level (CNEL). The accumulation for CNEL is adjusted to give more weight to the noise occurring between 1900 and 2200 hours and most weight to noise occurring between 2200 and 0700 hours. The annual CNEL at different locations is used to determine the noise impact area according to the boundary at which the annual CNEL is equal to a set value and according to the land use. The criterion value set for the CNEL is to be lowered in subsequent years.

These requirements on the noise monitoring systems show that something appreciably more complex than a sound-level meter and recorder is required, and specialized systems have been developed for this purpose. A noise-monitoring terminal for this use should contain a microphone, an A-weighting network, squaring, averaging, integrating, conversion and timing circuits, and an output recording or logging device. This terminal can be used as a separate monitoring device, or, similar terminals with the addition of conversion circuits and transmission lines can be tied in as part of a computer-controlled system to monitor the noise over a wide area surrounding an airport.

As a result of the work done for the EPA the day-night equivalent level (L_{dn}) (see paragraph 4.12) will probably be generally used for rating airport noise, superseding earlier ratings of NEF and CNR (see paragraph 4.14). The day-night equivalent level can be obtained by use of the GR 1945 Community Noise Analyzer with the L_{eq}/L_{dn} option.

11.4.5 Site Selection. Noise and vibration are obvious factors to consider in the selection of a building site. Buildings for certain purposes (for example, concert halls and sound studios) may be much more expensive to design and build if they must be placed in a noisy environment and at the same time have low background noise. A careful study of the sound and vibration conditions at a site is essential for a proper estimate of a suitable design for such buildings. Some useful information can be obtained with a sound-level meter and with a vibration meter. But an octave-band analysis of the sound and vibration is much more useful, because the cost of isolating against low frequency noise is much greater than that of isolating high-frequency noise, and the knowledge of the level of low-frequency sounds and vibrations may be an essential element in cost studies.

A related problem is that of locating a studio within an existing building. Here, a careful survey of possible locations may lead to a significant saving in construction costs.

REFERENCES

- L.L. Beranek (1949), *Acoustic Measurements*, John Wiley & Sons, Inc., New York.
- K.A. Bowen and J.S. Graham (1967), "Noise Analysis: A Maintenance Indicator," *Mechanical Engineering*, Vol 89, #10, pp 31-33.
- D. Davis and C. Davis (1975), *Sound System Engineering*, H.W. Sams, Indianapolis.
- FAA (1969), Federal Aviation Regulations, Part 36-Noise Standards: Aircraft Type Certification, Federal Aviation Administration, Department of Transportation.
- Federal Coal Mine Health and Safety Act (1969), Public Law 91-173, 91st Congress, S.2917, December 30, 1969.
- C.A.W. Glew and D.C. Watson (1971), "The Octave Band Vibration Analyzer as a Machinery Defect Indicator," *Am Soc of Mech Engineers*, Paper 71-DE-47, April 1971.
- E. Meyer and H. Kuttruff (1962), "Progress in Architectural Acoustics," in Richardson and Meyer, 1962, pp 222-277.
- OSHA (1970), "Part 1910 — Occupational Safety and Health Standards," under authority of Williams-Steiger Occupational Safety and Health Act of 1970 (P.L. 91-596) (84 Stat. 1593, 1600; 29 U.S.C. 655, 657) Federal Register Vol 36, #105, May 29, 1971, Washington, D.C.
- M.C. Plummer and C.E. Van Wagoner (1978), "Balancing Rotating Machinery," GenRad Application Note.
- E.G. Richardson and E. Meyer, eds. (1962), *Technical Aspects of Sound Vol III*, Elsevier Publishing Company, Amsterdam.
- T.J. Schultz, "Problems in the Measurement of Reverberation Time," *Journal of the Audio Engineering Society*, Vol 11, #4, October 1963, pp 307-317.
- T.J. Schultz and B.G. Watters (1964), "Propagation of Sound Across Audience Seating," *J Acoust Soc Am*, Vol 36, #5, May 1964, pp 885-896.
- W.C. Sperry (1978), "Aircraft and airport noise," in D.M. Lipscomb and A.C. Taylor, Jr., eds., *Noise Control*, Van Nostrand Reinhold, New York, p 221.
- WHPCA (1969), Occupational noise-exposure regulations under Section 50-204.10 of the Walsh-Healey Public Contracts Act — Safety and Health Standards, *Federal Register*, Vol 34, #96, May 20, 1969, amended July 1, 1969.
- C.G. Wyder (1977), "Preventive Maintenance," in L.R. Higgins and L.C. Morrow, eds., *Maintenance Engineering Handbook*, third edition, McGraw-Hill, N.Y.

Chapter 12

Techniques, Precautions, and Calibrations

12.1 INTRODUCTION.

The previous chapter was designed to help in deciding what measurements need to be made for a given acoustic or vibration problem. This chapter and Chapters 13 and 14 discuss how to make measurements. Other chapters provide help in interpreting the results of measurements.

The goal is to make valid measurements (Stein, 1962). In order to achieve this goal, it is helpful to recognize that the results of a measurement are determined by a number of factors, among which are the following:

1. The phenomenon being measured.
2. The effect of the measurement process on the phenomenon being measured.
3. The environmental conditions.
4. The characteristics of the transducers and instruments being used at the time they are used.
5. The way the transducers and instruments are used.
6. The observer.

Although many useful measurements are made by those with little background in acoustics, the chances of making valid measurements are increased as the understanding of these factors becomes more thorough. Thus a good knowledge of vibration and acoustics, of transducers, of instruments, and of measurement techniques, is helpful in making noise measurements. In this chapter we shall, therefore, provide information that is particularly pertinent for measuring noise.

Even when one does not need to measure noise according to a standard procedure, it is often wise to try to do so if an appropriate standard can be found. The standards have been prepared to help obtain valid data. They are useful guides for the inexperienced, and they help the experienced to keep in mind the required steps in a measurement procedure. They help to make comparisons of measured results more meaningful.

Those who prepare the standards try to recognize as many of the problem areas as they can and they attempt to set the requirements and procedures to bring them under control. But, often significant compromises have to be made because not enough is known to resolve the problem, or the available instrumentation may be inadequate. As the state of the art advances, the standards can be improved correspondingly. It is, therefore, important to use the most recent standards.

The general standard ANSI S1.13-1971, "Standard Methods for the Measurement of Sound Pressure Levels," is particularly recommended.

A thorough study of the instruction books supplied with the instruments to be used will often make it clear how to make the most effective use of the instruments. Practice in their use on familiar sounds is also helpful, and acoustical calibrating signals are particularly good for this purpose.

As implied in the listing of factors that determine the measurement results, the use of a precision instrument does not guarantee that a measurement will be valid or accurate. When measurements are done properly, however, a precision instru-

ment will help to yield more consistent results than is possible with a less precise instrument. Better measurement techniques then will be less limited by instruments, and improved results can be obtained more readily.

An obvious but important rule in any measurement task is to review the results to see if they are reasonable. If they are not, try to track down possible sources of trouble, particularly simple things like poor connections, plugs in the wrong places, no power, low batteries, controls set incorrectly, damaged equipment, stray grounds and pickup. If nothing can be found that can be corrected to bring the data into line, perhaps the data only seem unreasonable because of limited understanding of the phenomena or of the measurement process.

The results of a noise measurement may be a key factor in resolving a noise problem. In addition, the experience and data often help in doing a better job on another noise problem. Careful records of noise measurements can be valuable for future reference on subsequent problems, and this possibility should be kept in mind in tackling a noise problem.

A recognition of the accuracy limitations of acoustic and vibration measurements is important, in order to be reasonable in the approach to a measurement problem. Thus, consistency to 0.1 dB or better is attainable in only a few laboratory calibration procedures in acoustics and not in general acoustical measurements. Field calibrations of sound-level meters at one frequency with a calibrator may be consistent to 0.5 dB or slightly better. A consistency of 1 dB is difficult in general measurements, even under carefully controlled conditions, but is a more reasonable goal than 0.1 dB.

It is useful to think of the measured result as an "estimate." It is an estimate not only because of the uncertainty in the measurement, but also because the phenomenon being studied is not absolutely stable. The uncertainty in the measurement includes a systematic uncertainty, which is determined by such effects as departures of the characteristics of the measurement system from the ideal as well as the influence of the instrumentation and the measurement conditions on the result, and an uncertainty due to the random nature of most sounds. This random nature is described in paragraphs 8.5, 8.6.6, and 12.2.4.

12.2 SOUND MEASUREMENTS.

Most of the applications discussed in the previous chapter require a measurement of sound level or of sound-pressure level as a function of frequency. These quantities are measured at a single point or at a number of points that are determined by the conditions of the application.

The basic procedure for measuring the sound level or the sound-pressure level at a given point is to locate the sound-level-meter microphone at that point and to note the reading of the sound-level meter. Some preliminary exploration of the sound field is usually necessary to determine that the point selected is the correct one. Some practical details regarding this measurement are also given in this chapter, but the actual manipulation of the individual instrument controls is discussed in the instruction books that are furnished with the instruments.

Microphones and sound-level meters have been discussed earlier but further comments are given here. We shall discuss the effects of extraneous influences, the recording of adequate data, the calibration of the instruments, and the interpretation of the data. Much of this discussion is necessary because no ideal instrument or combination of instruments and accessories is available that would be suitable for all conditions.

12.2.1 Effect of Observer and Meter Case. The observer can affect the measured data if he is close to the microphone or a sound source. When measurements are made in a live room and not close to a source, the effect is usually not important. But if measurements are made near a source, it is advisable for the observer to stand well to the side of the direct path between the source and the microphone. For precise measurements in a very dead room, such as an anechoic chamber, the instruments and the observer should be in another room with only the source, the microphone, the extension cable, and a minimum of supporting structure in the dead room.

For many measurements, however, it is most convenient to be able to carry the sound-level meter around. When held in the hand, the sound-level meter should be held in front of the observer with the sound coming from the side. The magnitude of the error that can be caused when the instrument is held can be evaluated from the data shown in Figure 12-1. These data show the difference between the readings of the meter with and without the observer present, as a function of frequency. It is apparent that, if the instrument is held properly, little error in reading of the over-all level will occur for most noises. For additional information on this subject, refer to R.W. Young (1962).

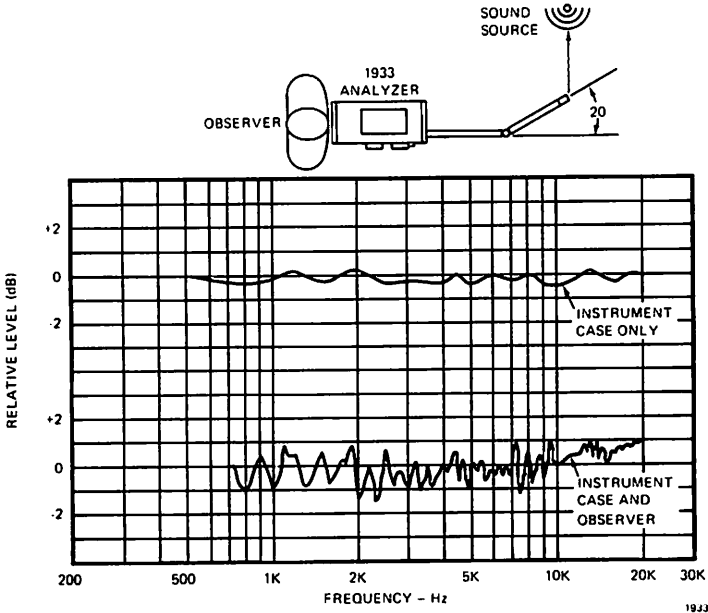

Figure 12-1. Error introduced by the presence of the instrument case and observer with microphone extended from the case and body. On the precision sound-level meter shown, the microphones fit atop a telescoping 18-in. extension to reduce the effects of the instrument and operator on the source field.

The meter case itself may also disturb the sound field at the microphone as shown by the other characteristic curve in Figure 12-1. There is practically no effect below 1000 Hz, and, again, on most noises, little error in measuring over-all level will result if the microphone is left on the instrument. When an analyzer is used with the sound-level meter, however, it is advisable to separate the microphone from the instruments and to use an extension cable. This refinement is not necessary, however, if the only data that are of interest are below 1000 Hz.

A 10-ft. cable is included with the 1982 and 1933 Precision Sound-Level Meter and Analyzers. They also have a detachable preamplifier that connects to the cable at the microphone end. Thus the instrument can readily be removed from the immediate vicinity of the measurement point without loss in usable signal.

Position of Microphone. In the chapter on microphones some comments have been made on various aspects of the problem of placing the microphone in the most satisfactory position for making the noise measurement. In general, the location is determined by the type of measurement to be made. For example, the noise of a machine is usually measured with the microphone placed near the machine according to the rules of a test code, or if its characteristics as a noise source are desired, a comparatively large number of measurements are made according to the methods and the placement given in Chapter 13.

It is important to explore the noise field before deciding on a definite location (paragraph 12.2.2) for the microphone.

Many measurement locations may be necessary for specifying the noise field, particularly if the apparatus produces a noise that is highly directional. Further discussion of directionality is given in paragraph 13.1.2.

If the noise level is measured for calculation of the speech-interference level or loudness level or for determination of deafness risk, it is important to explore the noise field to make sure that the measurement made is representative. The possible effects of obstacles in upsetting the distribution of sound, particularly at high frequencies, should be kept in mind during this exploration.

In a reverberant room, one with hard walls, floor and ceiling, at a point that is not close to a noise source, the sound arrives at that point from many different directions. Then the orientation of a microphone at that point is not critical, and the response that applies is assumed to be that labeled "random incidence," which is an averaged response. Under these conditions, nevertheless, it is usually desirable to avoid having the microphone pointing at a nearby hard surface, from which high-frequency sounds could be reflected to arrive perpendicular (0° incidence) to the plane of the diaphragm. (For all the microphones used in the GenRad Sound Measurement System this perpendicular incidence is along the axis of cylindrical symmetry of the microphone. This axis is used as the 0° reference line.) If this condition cannot be avoided, the possibility of errors from this effect can be reduced by some acoustic absorbing material placed on the reflecting surface.

When measurements are made in a reverberant room at varying distances from a noise source, the microphone should generally be oriented so that a line joining the microphone and the source is at an angle of about 70° from the axis of the microphone. When the microphone is near the source, most of the sound comes directly from the source and a 70° incidence response applies. On the other hand, near the boundaries of the room the incidence is more nearly random and the random-incidence response applies. These two response curves are nearly the same, so that there is little change in the effective response characteristics as the microphone is moved about the room. This desirable result would not be obtained if the microphone were pointed at the noise source.

If, however, a source is to be measured in a nearly anechoic or free-field space, the use of a microphone with a uniform response for perpendicular incidence may be preferred. Then the microphone can be pointed at the source, and the directional behavior will help to reduce the effects of extraneous noises. Although this type of microphone is acceptable for international standards on sound-level meters, it is not acceptable for ANSI S1.4-1971.

12.2.2 Effects of Room and Nearby Objects. The space in which tests are made can have a significant effect on the results. Unless the measurement room is well treated an appreciable standing wave can exist (see paragraph 13.1.4). If a small standing-wave pattern exists, the average of the maximum and minimum decibel readings found on exploration is often taken as a representative level. If the differences are more than 6 dB, the level is often taken as 3 dB below the maximum readings that occur frequently. This standing-wave pattern, however, should not be confused with the normal decrease in level with distance from a source or with the directivity pattern of a source.

Objects in the room reflect the sound waves just as do the walls of the room. In general, no objects, including the observer, should be close to the microphone.

One troublesome but not frequent effect of nearby objects results from sympathetic vibrations. A large, thin metal panel if undamped can readily be set into vibration at certain frequencies. If one of these frequency components is present in the noise, this panel can be set into motion either by airborne sound or by vibration transmitted through the structure. This panel vibration can seriously upset the noise field in its vicinity. One way of checking that this effect is not present to any important degree is to measure the sound field as a function of the radial distance from a source. If there is only one source in the room, the sound should decrease, when not very close to the source, about 6 dB as the distance is doubled. This procedure also checks for reflections in general.

When the acoustical environment is being measured, no change should be made in the usual location of equipment, but the sound field should be explored to make sure that the selected location for the microphone is not in an acoustic shadow cast by a nearby object or is not in a minimum of the directivity pattern of noise sources.

12.2.3 Instrument Precautions. *Low Noise Levels — Effect of Circuit Noise.* When low noise levels are to be measured, the inherent circuit noise may contribute to the measured level. This effect is usually noticeable in the range below 40 dB when a small microphone is used or a ceramic microphone is used on the end of a very long cable. If the microphone is directly on the sound-level meter, the level at which this effect may be important is below 30 dB, if the C weighting is used or even lower if the A or B weighting is used. To measure the circuit noise the microphone may be replaced by a well-shielded capacitor with a capacitance equal to that of the microphone. A correction can sometimes be made for this noise, if necessary, by the same procedure as outlined for background noise in paragraph 13.3. If the circuit noise is comparable to the noise being measured, some improvement in the measurement can usually be obtained by use of an octave-band analyzer. The circuit noise in each band should be checked also to see if correction is necessary.

Whenever low noise levels must be measured and extension cables are used, the Type 1560-P42 or P40 Preamplifier or 1972-9600 Preamplifier Adapter should be used at the microphone.

Hum Pickup. When noise is measured near electrical equipment, a check should be made that there is no appreciable pickup of electro-magnetic field in the sound-measuring system. The procedure depends on the directional character of the field. The orientation of the instruments should be changed to see if there is any significant change in level. If an analyzer is used, it should be tuned to the power-supply frequency, usually 60 Hz, which would be the 63-Hz band for the octave-band analyzer, when this test is made. If no analyzer is included, the C-weighting should be used in this test to make the effect of hum most noticeable, and a good-quality pair of earphones, with tight-fitting ear cushions, should be used to listen to the output of the sound-level meter.

If the hum pickup is in the instruments, they can usually be moved away from the source of the electromagnetic field, or, alternatively, a proper orientation is usually sufficient to reduce the pickup to a negligible value.

When ac-operated instruments are used as part of the measuring setup, a check should be made for 120-Hz as well as 60-Hz hum. This hum may be in the instruments, or it may appear as a result of the interconnection of different instruments. These two possibilities may be distinguished by a check of the instruments individually. If each is separately essentially free from hum, different methods of grounding, balancing, or shielding should be tried. Sometimes reversal of the power-plug connection to the line helps to reduce the hum.

High Sound Levels — Microphonics. Some electronic devices are affected by mechanical vibration. Those used in sound-measuring equipment have been selected to be less sensitive to vibration than the usual types. But at sufficiently high sound levels, even these can be vibrated to such an extent that they contribute an undesired signal to the output. Connecting cables can also generate an interfering signal when vibrated. Trouble from this effect, which is called microphonics, is not usually experienced until the sound levels are well above 100 dB, unless the instruments are placed on supports that carry vibrations directly to the instruments.

The usual test for microphonics is to disconnect the microphone and observe whether or not the residual signal is appreciably lower than the signal with the microphone connected. The instruments can also be lifted up from the support on which they have been placed to see whether or not the vibrations are transmitted through the supports or if it is the airborne sound that is causing the vibration.

Possible remedies for microphonic troubles are as follows:

1. Place the instruments on soft rubber pads.
2. Remove the instruments from the strong field to another room and interconnect with long cables.
3. Put in deadened sound barriers between the instruments and the sound source.

Mechanical vibration also affects the microphone itself, in that the output of the microphone is dependent on the airborne and solid-borne vibrations that are impressed upon it. The effects of the solid-borne vibrations are not usually important in the standard, sensitive microphones because of the type of construction used; but these vibrations are usually of great importance for low-sensitivity microphones used in the measurement of high sound levels. A mechanically soft mounting should generally be used for such a microphone, in order to avoid trouble from these vibrations. Often merely suspending the microphone by means of its connecting cable is adequate.

12.2.4 Interpretation of the Meter Pointer. Two ballistic characteristics are provided for the meter on the sound-level meter: When the "FAST" position is used, it will be noticed that most sounds do not give a constant level reading. The reading fluctuates often over a range of a few decibels and sometimes over a range of many decibels, particularly in analysis at low frequencies. The maximum and minimum readings should usually be noted. These levels can be entered on the data sheet as, say, 85-91 dB or 88 ± 3 dB.

When an average sound-pressure level is desired and the fluctuations are less than 6 dB, a simple average of the maximum and minimum levels is usually taken. If the range of fluctuations is greater than 6 dB, the average sound-pressure level is usually taken to be 3 dB below the maximum level. In selecting this maximum level, it is also customary to ignore any unusually high levels that occur infrequently.

The "SLOW" meter speed should be used to obtain an average reading when the fluctuations on the "FAST" position are more than 3 or 4 dB. On steady sounds the

reading of the meter will be the same for either the "SLOW" or "FAST" position, while on fluctuating sounds the "SLOW" position provides a long-time average reading.

A more detailed discussion of this problem is given in succeeding paragraphs.

Tones and Beats. The indicated sound level of a constant-amplitude pure tone is steady, and so is that of a mixture of tones, unless at least two components are close together in frequency. Examples of sounds that have a constant indicated sound level are transformer hum and noise from some rotating electrical machinery. When the combined noise of several machines is measured, the indicated level is also constant, unless the speed of the machines is such that some of the major noise components are only a few cycles apart in frequency. In this situation an audible beat, a periodic rise and fall in amplitude, occurs, and the indicated level also rises and falls.

Varying-Speed Sources. Machinery that operates at a varying speed usually produces a noise that fluctuates in level. If the speed varies periodically, the level will also vary periodically. This variation results because the noise produced by the machine varies with speed, because the response of the room in which the measurement is made varies with frequency, and, if an analyzer is used, because the response of the measurement system varies with frequency.

If the machine speed varies erratically, the noise level will also vary erratically, and the behavior may be similar to that of random noise.

Random Noise. The indicated sound level of a random noise, such as that produced by jets, blowers, combustion chambers, ventilating systems, etc., is not steady. In fact, all sounds contain some random noise energy, and most have enough so that the indicated level fluctuates noticeably. The extent of the fluctuation is a clue to the nature of the sound.

The fluctuations in level are ordinarily not a result of erratic behavior of the measuring equipment, but rather reflect the irregularities in the process of noise production. This process can often be considered as a combination of many sources that produce sound at random time intervals. The measurement of such noises can be treated on a simplified statistical basis that is satisfactory for almost all sounds.

Average Energy Level of a Random Noise. When a random noise is measured, the first important result that is desired is the long-time average energy level. This concept leads to taking the average of the fluctuating pointer reading. If the fluctuations are less than about 2 dB, this average can be easily and confidently estimated to a fraction of a decibel. If the fluctuations cover a range of 10 dB or more, the average is much less certain.

The extent of the meter fluctuation depends on the meter characteristic. The slower the movement, the smaller are the fluctuations. Thus, if the fluctuations exceed 3 or 4 dB for the "FAST" meter position, the "SLOW" meter position should be used.

When the fluctuations are large, the nature of the source or sources should be considered. If the noise-generating mechanism shifts from one mode to another, it may be desirable to characterize the noise level by more than one average value. This choice is obvious for a dishwasher, for example, where the wash, rinse, and dry cycles differ significantly. But this choice may also be useful in machines where the mode shifts more rapidly.

If the noise is random and the fluctuations are large only because the effective noise bandwidth is small (see paragraph 8.6.6) the average value should be obtained on an energy basis.

12.3 CALIBRATION AND CORRECTIONS.

Satisfactory noise measurements depend on the use of measuring equipment that is kept in proper operating condition. Although the instruments are reliable and stable, in time the performance of the instruments may change. In order to ensure that any

important changes will be discovered and corrected, certain simple checks have been provided for the GenRad line of sound-level equipment, and these will be discussed in this section. These checks can be made as routine maintenance checks, and some of them should usually be made before and after any set of noise measurements.

For example, certain Federal regulations require that "calibration of the sound-level meter measuring system will be conducted at the beginning of a series of measurements and every 5 to 15 minutes thereafter until the system has not drifted from its established level. At that point calibrations are required every hour."* Most modern sound-measuring instruments stabilize quickly, and a series of repeated calibrations will not usually be required.

In addition to these routine checks, more complete calibration of the system may be desirable for accurate measurements, particularly above 1000 Hz. These calibrations are also discussed in this section.

Acoustical Calibration at Preferred Frequencies. The 1986 Omnical Sound-Level Calibrator provides an over-all system calibration at 125, 250, 500, 1000, 2000, and 4000 Hz. If a record is kept of the calibration of a microphone as a function of frequency, any significant change in the relative calibration is readily noticed. If such a change occurs, the microphone and the calibrator should be checked as soon as possible. Here, it is useful to have more than one microphone on hand, so that a second microphone can be used if the first is damaged; at the same time, a consistency check on its calibration can help to ensure that the calibrator has not been damaged.

In the interests of maintaining accuracy in sound measurements, another calibration service is provided for owners of GenRad instruments. If these instruments are brought in to one of the GenRad offices, the level will be checked by means of an acoustic calibrator. This calibration will usually show if the instrument is operating correctly. If there is a serious discrepancy, the situation will have to be handled as a regular service problem.

For high accuracy, it is usually essential to have a calibration of the microphone response characteristic as a function of frequency. When this calibration is available and an analysis of a noise is made, correction can be made for the microphone frequency-response characteristic. This correction can be applied only if the noise is analyzed or if the sound is dominated by a component of known frequency, as, for example, in the measurement of loudspeaker response. Otherwise, one must check the uniformity of response of a system to be sure that the measured level of a noise is correct.

Calibration At High Frequencies. The accurate calibration of a microphone at high frequencies in terms of sensitivity vs frequency requires elaborate facilities. Only a few laboratories (eg., The National Bureau of Standards) offer such calibration as a regular service. GenRad will calibrate response vs frequency only for those microphones that it supplies. Such calibration is supplied with all microphones manufactured by GenRad.

At GenRad, a free-field perpendicular-incidence calibration is made by comparison with laboratory-standard condenser microphones (ANSI S1.12-1967 Specifications for Laboratory Standard Microphones), according to the methods given in S1.10-1966, Calibration of Microphones. The working-standard microphones are periodically compared with a condenser microphone that has been calibrated at the National Bureau of Standards. They are also periodically calibrated on an absolute basis by the reciprocity method.

Since the sound-level meter standard in the USA is based on a random-incidence specification, for those microphones rated for uniform random-

*Bureau of Motor Carrier Safety, DOT, Part 325 added to Chapter III, Title 49, Code of Federal Regulations, issued September 12, 1975.

incidence response, the perpendicular incidence calibration is automatically converted to the random incidence calibration in the plotting procedure, so that calibrations supplied by GenRad are for random-incidence response, and data for converting to perpendicular-incidence or grazing-incidence calibrations are included in the instruction book. For those microphones rated for uniform perpendicular-incidence response, the perpendicular incidence response is supplied.

Correction For Frequency-Response Characteristic. It is customary to set the calibration of an acoustical measurement system to indicate the correct level at 400 or 500 Hz. At other frequencies, for improved accuracy the differences between true and indicated levels, as determined from a calibration curve, can be applied as corrections to the results of a noise analysis. At frequencies above 1000 Hz, the directional characteristic of the microphone should be taken into account, and the particular curve that corresponds to the actual angle of incidence used should be used for the corrections.

Comparison Test Among Different Sound-Level Meters. When measurements are made on the same sound with two different sound-level meters, it is commonly found that the readings differ by an amount that is within the accuracy tolerance of the two instruments.

In order to set an upper limit to these differences among sound-level meters, the International Standards and the American National Standard set certain tolerances on the prescribed frequency characteristics. Representative values from the most recent International Standard (IEC 651) tolerances on the weighting characteristics are shown in Table 12-1, and from the American Standard in Tables 12-2 and 12-3.

Table 12-1

Tolerances of weighting characteristics from IEC standard (The Type 0 sound-level meter is one for standard laboratory use only).

| Nominal Frequency Hz | Tolerances in dB | | | |
|-------------------------|------------------|----------|--------|--------|
| | Type 0 | Type 1 | Type 2 | Type 3 |
| 10 to 16 | +2, -∞ | +3, -∞ | +5, -∞ | +5, -∞ |
| 20 | ±2 | ±3 | ±3 | +5, -∞ |
| 25 | ±1.5 | ±2 | ±3 | +5, -∞ |
| 31.5 | ±1 | ±1.5 | ±3 | ±4 |
| 40 | ±1 | ±1.5 | ±2 | ±4 |
| 50 to 80 | ±1 | ±1.5 | ±2 | ±3 |
| 100 | ±0.7 | ±1 | ±1.5 | ±3 |
| 125 to 1000 | ±0.7 | ±1 | ±1.5 | ±2 |
| 1250 | ±0.7 | ±1 | ±1.5 | ±2.5 |
| 1600 | ±0.7 | ±1 | ±2 | ±3 |
| 2000 | ±0.7 | ±1 | ±2 | ±3 |
| 2500 | ±0.7 | ±1 | ±2.5 | ±4 |
| 3150 | ±0.7 | ±1 | ±2.5 | ±4.5 |
| 4000 | ±0.7 | ±1 | ±3 | ±5 |
| 5000 | ±1 | ±1.5 | ±3.5 | ±6 |
| 6300 | +1, -1.5 | +1.5, -2 | ±4.5 | ±6 |
| 8000 | +1, -2 | +1.5, -3 | ±5 | ±6 |
| 10000 | +2, -3 | +2, -4 | +5, -∞ | +6, -∞ |
| 12500 | +2, -3 | +3, -6 | +5, -∞ | +6, -∞ |
| 16000 to 20000 | +2, -3 | +3, -∞ | +5, -∞ | +6, -∞ |

Table 12-2

Response characteristics and tolerances for C weighting (ANSI S1.4-1971)

| Frequency Hz | C Weighting dB | Tolerance Limits -dB | | |
|-----------------|-------------------|----------------------|------------|------------|
| | | Type 1 | Type 2 | Type 3 |
| 10 | -14.3 | ±2.5 | | |
| 12.5 | -11.2 | ±2 | | |
| 16 | - 8.5 | ±2 | | |
| 20 | - 6.2 | ±2 | +3.0, -∞ | +4.0, -∞ |
| 25 | - 4.4 | ±1.5 | +2.0, -2.5 | +3.0, -4.5 |
| 31.5 | - 3.0 | ±1.5 | +1.5, -2.0 | +2.5, -3.0 |
| 40 | - 2.0 | ±1 | +1.0, -1.5 | +2.0, -2.5 |
| 50 | - 1.3 | ±1 | ±1.0 | ±2.0 |
| 63 | - 0.8 | ±1 | ±1.0 | ±2.0 |
| 80 | - 0.5 | ±1 | ±1.0 | ±2.0 |
| 100 | - 0.3 | ±1 | ±1.0 | ±2.0 |
| 125 | - 0.2 | ±1 | ±1.0 | ±2.0 |
| 160 | - 0.1 | ±1 | ±1.0 | ±2.0 |
| 200 | 0 | ±1 | ±1.0 | ±2.0 |
| 250 | 0 | ±1 | ±1.0 | ±2.0 |
| 315 | 0 | ±1 | ±1.0 | ±2.0 |
| 400 | 0 | ±1 | ±1.0 | ±2.0 |
| 500 | 0 | ±1 | ±1.0 | ±2.0 |
| 630 | 0 | ±1 | ±1.0 | ±2.0 |
| 800 | 0 | ±1 | ±1.0 | ±2.5 |
| 1000 | 0 | ±1 | ±1.5 | ±2.5 |
| 1250 | 0 | ±1 | ±1.5 | ±2.5 |
| 1600 | - 0.1 | ±1 | ±2.0 | ±3.0 |
| 2000 | - 0.2 | ±1 | ±2.5 | ±3.5 |
| 2500 | - 0.3 | ±1 | +3.5, -3.0 | ±4.0 |
| 3150 | - 0.5 | ±1 | +4.5, -3.5 | ±4.5 |
| 4000 | - 0.8 | ±1 | +5.0, -4.0 | ±5.0 |
| 5000 | - 1.3 | +1.5, -2 | +5.5, -4.5 | ±6.0 |
| 6300 | - 2.0 | +1.5, -2 | +6.0, -5.0 | ±7.0 |
| 8000 | - 3.0 | +1.5, -3 | ±6.0, -6.0 | ±7.0 |
| 10000 | - 4.4 | +2, -4 | +6.0, -∞ | +7.0, -∞ |
| 12500 | - 6.2 | +3, -6 | | |
| 16000 | - 8.5 | +3, -∞ | | |
| 20000 | -11.2 | +3, -∞ | | |

Table 12-3

Response characteristics and tolerances for A-weighting (ANSI S1.4-1971)

| Frequency Hz | A Weighting dB | Tolerance Limits -dB | | |
|-----------------|-------------------|----------------------|------------|------------|
| | | Type 1 | Type 2 | Type 3 |
| 10 | -70.4 | ±4 | | |
| 12.5 | -63.4 | ±3.5 | | |
| 16 | -56.7 | ±3 | | |
| 20 | -50.5 | ±2.5 | +5.0, -∞ | +6.0, -∞ |
| 25 | -44.7 | ±2 | +4.0, -4.5 | +5.0, -6.0 |
| 31.5 | -39.4 | ±1.5 | +3.5, -4.0 | +4.5, -5.0 |
| 40 | -34.6 | ±1.5 | +3.0, -3.5 | +4.0, -4.5 |
| 50 | -30.2 | ±1 | ±3.0 | ±4.0 |
| 63 | -26.2 | ±1 | ±3.0 | ±4.0 |
| 80 | -22.5 | ±1 | ±3.0 | ±3.5 |
| 100 | -19.1 | ±1 | ±2.5 | ±3.5 |
| 125 | -16.1 | ±1 | ±2.5 | ±3.0 |
| 160 | -13.4 | ±1 | ±2.5 | ±3.0 |
| 200 | -10.9 | ±1 | ±2.5 | ±3.0 |
| 250 | -8.6 | ±1 | ±2.5 | ±3.0 |
| 315 | -6.6 | ±1 | ±2.0 | ±3.0 |
| 400 | -4.8 | ±1 | ±2.0 | ±3.0 |
| 500 | -3.2 | ±1 | ±2.0 | ±3.0 |
| 630 | -1.9 | ±1 | ±2.0 | ±3.0 |
| 800 | -0.8 | ±1 | ±1.5 | ±3.0 |
| 1000 | 0 | ±1 | ±2.0 | ±3.0 |
| 1250 | +0.6 | ±1 | ±2.0 | ±3.0 |
| 1600 | +1.0 | ±1 | ±2.5 | ±3.5 |
| 2000 | +1.2 | ±1 | ±3.0 | ±4.0 |
| 2500 | +1.3 | ±1 | +4.0, -3.5 | ±4.5 |
| 3150 | +1.2 | ±1 | +5.0, -4.0 | ±5.0 |
| 4000 | +1.0 | ±1 | +5.5, -4.5 | ±5.5 |
| 5000 | +0.5 | +1.5, -2 | +6.0, -5.0 | ±6.5 |
| 6300 | -0.1 | +1.5, -2 | +6.5, -5.5 | ±7.0 |
| 8000 | -1.1 | +1.5, -3 | +6.5, -6.5 | ±7.5 |
| 10000 | -2.5 | +2, -4 | +6.5, -∞ | +7.5, -∞ |
| 12500 | -4.3 | +3, -6 | | |
| 16000 | -6.6 | +3, -∞ | | |
| 20000 | -9.3 | +3, -∞ | | |

When the differences are significantly larger than would be expected from the above tolerances, the instruments may not be operating properly. But it can also be that the two instruments are not really measuring the same sound. Even though care is taken in the comparison setup it is sometimes very difficult to ensure that the comparison is a valid one, particularly if the sound has dominant high-frequency components.

When the sound has dominant high-frequency components, it is also important to be sure that the response characteristics of the microphones are intended to be similar. Some instruments that are normally sold to the European markets are also sold in the USA. The user must be certain then that the microphone on such a unit meets the random-incidence requirements of the ANSI standard for measurements in the USA. Some instruments that meet IEC standards do not also meet the ANSI standard. At high frequencies such an instrument may read lower than it should unless the sound is incident along the axis of the microphone.

If the sound is an impulsive sound, the differences in readings among sound-level meters may be significant. The response characteristics to such sounds are not adequately specified in existing standards. Future standards are planned that will improve this situation.

Incidentally, when a sound-level meter is calibrated with a calibrator, the calibrator tolerances as well as these tolerances should be considered in comparing the actual sound-level meter reading with the expected calibration level.

Effect of C Weighting on Band Levels. In principle, the response of the equipment supplying an analyzer should be as uniform as possible to obtain true pressure levels. Sometimes the "C" weighting is used for octave-band measurements. If this is done for instruments meeting the latest ANSI and International standards, there will be small differences in level at the low- and high-frequency ends, compared with the levels that would be obtained with a more nearly uniform response, because of the specified roll-offs in response for the C weighting. Thus, the C-weighted octave-band level is less, by about 3 dB for the bands centered at 31.5 and 8000 Hz, and by 0.8 dB for the bands at 63 and 4000 Hz, than with the uniform response weighting (flat). The shifts in level for the bands in between are too small to be significant.

Check On Over-All Level. When an octave-band analysis has been made, it is good practice to check that the sum of the individual band levels on an energy basis (see Appendix II) is equal within 1 or 2 dB to the over-all level. If this result is not obtained, an error exists, either in the summing or the measurement procedure, because of faulty or incorrectly used equipment, or because the noise is of an impact type. Impact-type noises sometimes give over-all levels appreciably less than the sum of the levels in the individual bands, even when the fast position of the meter switch is used. This result is obtained because of the inability of the meter to indicate the instantaneous levels occurring in very short intervals. The narrow-band levels at low frequencies tend to be nearer the peak value in those bands, while the over-all and high-frequency bands are significantly less than the peak value.

Effects of Atmospheric Pressure. Some acoustical measurements are affected by atmospheric pressure and temperature. The output of a calibrator, for instance, varies somewhat with pressure, and the rated reference level occurs at a standard atmospheric pressure of 1013 millibars. If the pressure when the calibrator is used is significantly different from 1013 millibars, a correction should be

made. The altitude where the calibrator is used is usually the most significant factor in determining the average atmospheric pressure, and a chart for correcting for this effect is included in the calibrator instruction book (see Figure 12-2). Since the output of most other sound sources is affected by the pressure, a chart relating height to average pressure is included here (Figure 12-3). The actual variation in output with pressure for practical sources is usually between that shown by the corresponding decibel scale on the right and one-half that value. Thus, for altitudes up to 2 km (6560 ft), the change in output with altitude is generally less than 2 dB.

The variation of atmospheric pressure at a given location from day to day is usually less important, but for careful measurements where fractions of a decibel are being considered, the actual atmospheric pressure should be noted. The pressure can be obtained from the local weather bureau, and a correction for the difference in altitude between the point where the acoustical measurements are made and the weather bureau may be necessary. This correction is readily estimated from the chart.

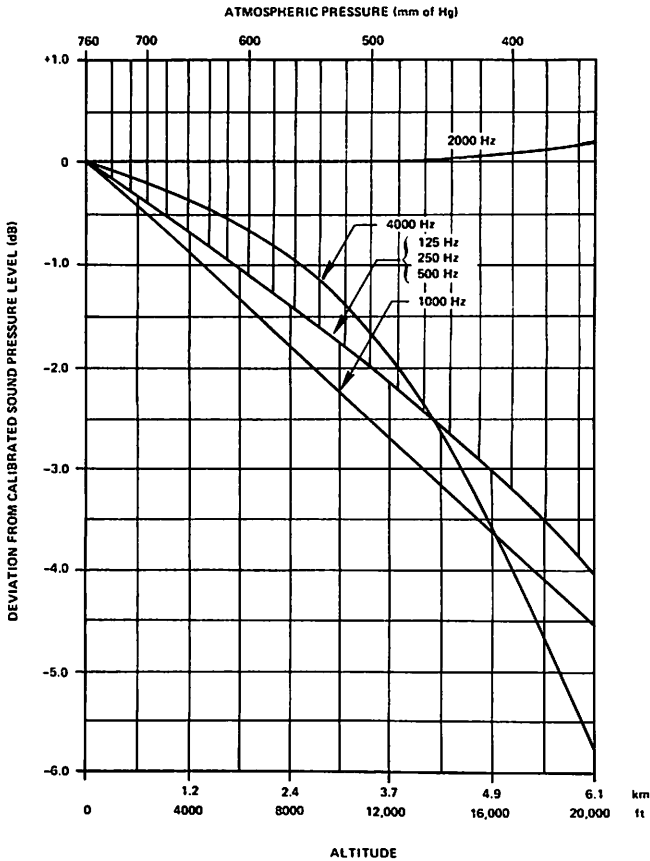

Figure 12-2. Change in output of the GR 1986 Omnicast Sound-Level Calibrator as a function of atmospheric pressure.

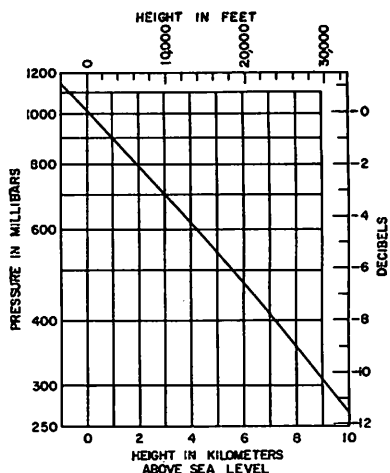
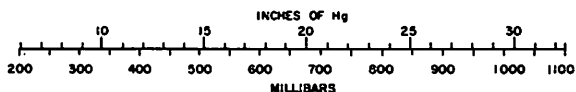

Figure 12-3. Relation between height above sea level and atmospheric pressure. The decibel scale on the right shows the approximate change in sound level to be expected from some sources.



12.4 EARPHONES AND STETHOSCOPE

A pair of high-quality earphones with tight-fitting earphone cushions is a useful accessory for noise measurements, and high-impedance dynamic or crystal-type phones are recommended. Good earphone cushions are essential to improve the low-frequency response and to help reduce the leakage of external noise under the earphone.

When a measurement system is being set up, the earphones should be plugged into the output of the sound-level meter. Then a listening test should be made to determine that the noise heard in the earphones is the same type of noise heard without the earphones. It is possible to detect trouble from microphonics (usually a ringing sound) or stray pickup in this fashion.

When the noise level is high, say, 90 dB or higher, the leakage of external noise under the earphone may be sufficient to mask the sound from the earphones. Then the earphone cushions should be checked for tightness of fit. In addition, the signal from the earphones can be increased by use of an attenuator setting on the sound-level meter 10 dB lower than that required for a satisfactory reading on the meter. This change of 10 dB is usually not enough to overload the output, but a large change should be avoided. It may also be desirable to have a long cord available, so that it is possible to listen to the output of the earphones far from the noise source.

The earphones can also be used on the output of an analyzer to detect troubles from stray pickup. In addition, a listening test may help one to determine which frequency bands contain the noise that is most objectionable in a given situation.

When the noise level is very high, the earphones on the sound-level meter may be useful in improving speech communication between observers during a measurement run. One observer wears the earphones then the other observer shouts into the sound-level meter microphone. A definite improvement in speech communication results.

A similar procedure using a nonelectrical, medical stethoscope is also possible. One observer has the ear tips in place, and the other speaks into the receiver of the stethoscope.

Plant-Noise Survey Form

DATE: 1/2/69
METER #: 6547

LOCATION: Building 1, Second Floor, Cable Binding Area

NUMBER OF PERSONNEL EXPOSED: 2

WEARING EAR PROTECTION? yes no

OPERATOR: J. R. LaConnor

SIGNED: P. G. Adam

DIAGRAM: (Show measuring location with an X.)

dB(A)

| Location | P | Q | R |
|----------|------|----|------|
| #1 on | 99 | 95 | 91.5 |
| #2 on | 89.5 | 92 | 96.5 |
| Both on | 99.5 | 97 | 98 |

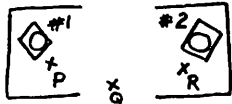

- 1965 PROCEDURE CHECK LIST
1. REMOVE WHITE CAP
 2. SELECT A WEIGHTING, SLOW METER RESPONSE (OR C WEIGHTING, FAST RESPONSE FOR IMPACT NOISE).
 3. TURN ATTENUATOR KNOB TO GET SCALE READING (OR TO 140 DB FULL SCALE FOR IMPACT NOISE).
 4. ADD READING TO KNOB SETTING TO GET TOTAL DB.

NOTES: — Operator goes back and forth between machines.
 — Set-up time: ~4 min.; Initial run: ~1 min.
 — 5 minutes at Q, alternate runs.
 — 25 cables/day average. Worst case used.
 — Both machines not always on during initial part of run.

| DB(A) MAX LEVEL | EXPOSURE TIME If necessary, note time of day | D P | | D/P |
|---|---|---------------------------------|---------------------------|---|
| | | TOTAL DURATION IN HOURS PER DAY | PERMISSIBLE HOURS PER DAY | |
| OVER 115 | | | NONE | |
| 115 | | | 1/2 | |
| 110 | | | 1/2 | |
| 105 | | | 1 | |
| 102 | | | 1 1/2 | |
| 100 | 25 times at 1 minute each | .42 | 2 | .21 |
| 97 | 13 times at 5 minutes each | 1.08 | 3 | .36 |
| 95 | | | 4 | |
| 92 | 13 times at 4 minutes each | .87 | 6 | .15 |
| 90 | 12 times at 4 minutes each | .80 | 8 | .10 |
| UNDER 90 | coffee break, lunch, cable layout - 4:50 total | 4.83 | ANY | 0 |
| IMPACT CHECK (MUST BE UNDER 140 DB PEAK SOUND PRESSURE LEVEL, AS MEASURED WITH AN IMPACT NOISE ANALYZER, OR BE UNDER 125 DB AS MEASURED WITH A SOUND LEVEL METER ON C WEIGHTING, FAST RESPONSE, 140 DB FULL SCALE RANGE.) | | | | TOTAL .92 To comply with regulations, total cannot be more than 1. |

Max - 101 dB(C)

RECOMMENDATIONS: Continue use of ear protection

Figure 12-4. A sound-survey data sheet.

12.5 RECORD OF MEASUREMENTS

One important part of any measurement problem is obtaining sufficient data. The use of data sheets designed specifically for a noise problem helps to make sure that the desired data will be taken and recorded; a sample data sheet is shown in Figure 12-4. The following list of important items may be found helpful in preparing data sheets of this type:

1. Description of space in which measurements were made. Nature and dimensions of floor, walls, and ceiling. Description and location of nearby objects and personnel.
2. Description of device under test (primary noise source). Dimensions, name-plate data and other pertinent facts including speed and power rating. Kinds of operations and operating conditions. Location of device and type of mounting.

3. Description of secondary noise sources. Location and types. Kinds of operations.
4. Type and serial numbers on all microphones, sound-level meters and analyzers used. Length and type of microphone cable.
5. Positions of observer.
6. Positions of microphone. Direction of arrival of sound with respect to microphone orientation. Tests of standing-wave patterns and decay of sound level with distance.
7. Temperature.
8. Results of maintenance and calibration tests.
9. Weighting network and meter speed used.
10. Measured over-all and band levels at each microphone position. Extent of meter fluctuation.
11. Background over-all and band levels at each microphone position. Device under test not operating.
12. Cable and microphone corrections.
13. Date and time.
14. Name of observer.

When the measurement is being made to determine the extent of noise exposure of personnel, the following items are also of interest:

1. Personnel exposed — directly and indirectly.
2. Time pattern of the exposure.
3. Attempts at noise control and personnel protection.
4. Audiometric examinations. Method of making examinations. Keeping of records.

The sample form shown in Figure 12-4 is appropriate for a noise survey for noise exposure calculations under the Occupational Safety and Health Act of 1970 (84 Stat. 1593) (See Chapter 3 and “*Primer of Plant-Noise Measurement and Hearing Testing*,” GenRad, 1971).

REFERENCES

Standards

ANSI S1.2-1962 (R1976) Physical Measurement of Sound

ANSI S1.4-1971 Sound Level Meters

ANSI S1.11-1966 Octave, Half-Octave, and Third-Octave Band Filter Sets

ANSI S1.13-1971 Standard Methods for the Measurement of Sound Pressure Levels

IEC 651-1979 Sound Level Meters

Other

W.R. Kundert (1977), “Sound Level Meters: The State of the Art,” *Noise Control Engineering*, Vol 9, #3, Nov-Dec 1977, pp 120-130.

P.K. Stein (1962), *Measurement Engineering*, Stein Engineering Services.

R.W. Young (1962), “Can Accurate Measurements be Made with a Sound-Level Meter Held in Hand?” *Souvo*, Vol 1, #1, Jan-Feb, pp 17-24.

Chapter 13

Source Measurements (Product Noise) — Sound Fields, Sound Power

13.1 SOUND FIELDS.

The behavior of sound in various environments has been described briefly at various places in this book. We shall now discuss it in more detail in order to explain how sound-power measurements are made.

We shall begin with a discussion of a simple source under idealized conditions. Then we shall point out various factors that alter the idealized conditions and discuss in general what the important effects are.

13.1.1 Simple Source in Free Field.

Point Source. Any vibrating object will radiate sound into the air. The amount of sound radiated depends on the amplitude of vibration of each vibrating part, the area of each part, and the time pattern of the vibrations, including the relative time pattern compared with that of the other parts.

The simplest form of source is a sphere that vibrates uniformly over its entire surface. We can think of this source as a round balloon with air in it. We periodically pump some more air into it and then let the same amount of air out. If the surface of the balloon then expanded and contracted uniformly, the balloon would be a simple, spherical source. This source radiates sound equally in all directions from an apparent center, which is the center of the balloon. It then is a "point" source, insofar as sound radiation is concerned.

Free Field. If such a point (or spherical) source is in the air far from any other objects, including the ground, the sound pressure produced by the source is the same in every direction at equal distances from the point source. Furthermore, the sound pressure is halved for each doubling of distance from the point. This change is usually expressed as a decrease in sound-pressure level of 6 dB. The sound field produced under these idealized conditions is called a free sound field or, simply a free field because it is uniform, it is free from all bounding surfaces, and it is undisturbed by other sources of sound.

Power Level in Free Field. Under free-field conditions, a single measurement* of the sound-pressure level at a known distance from a point source is enough to tell us all about the sound field radiated by the source. For example, we can then predict the level at any other point, since the sound pressure varies inversely as the distance from the source. We can also compute the total sound power radiated by the point source. This calculation is usually made in terms of the power level 10^{-12} watt (L_w) of the source (paragraph 2.3). Then the required relation to the sound-pressure level (L_p) is:

$$L_w = L_p + 20 \log r + 0.5 \text{ dB}$$

*The concept of a point source is an idealized one. It is not reasonable to assume that an actual source is a true point source, so that one should never be content with a single measurement.

where r is the distance in feet from the point source to the point where the sound-pressure level is measured. If r is in meters, the relation is:

$$L_w = L_p + 20 \log r + 10.82 \text{ dB}$$

This relation is correct for a point source in a free field at normal room temperature and barometric pressure, that is, 20°C and 1013 millibars. At other temperatures and pressures, the correction shown in the graph of Figure 13-1 applies. This correction is usually unimportant.

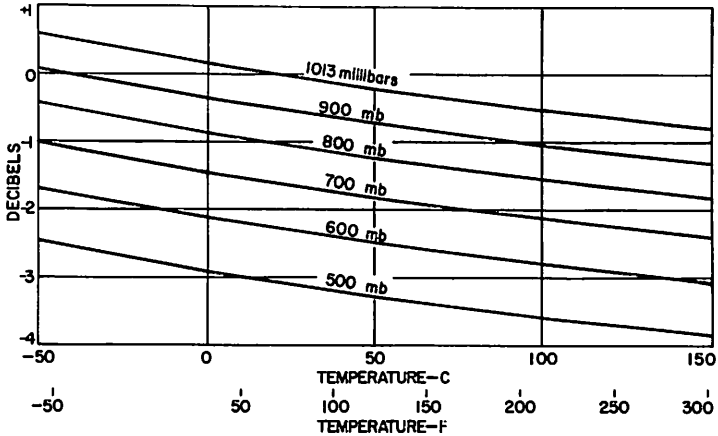

Figure 13-1. Corrections for temperature and barometric pressure to be applied when the equations relating power level (L_w) and sound-pressure level (L_p) are used. The correction is to be added to, if positive, or subtracted from, if negative, the sound-pressure level computed by the equation from the power level. If the power level is to be computed from a given sound-pressure level, the correction should be subtracted from, if positive, or added to, if negative, the given sound-pressure level before the numerical value is substituted in the equation.

As an example, suppose that we measure a sound-pressure level of 73.5 dB re 20 μ Pa at a distance of 20 ft from a point source. Then

$$L_p = 73.5 + 20 \log 20 + 0.5 = 100 \text{ dB re } 10^{-12} \text{ W.}$$

The value for $20 \log r$ can be calculated on a calculator or from the decibel tables in the Appendix, where the columns labeled as pressure ratios should be used for this distance.

The power level can be converted to actual acoustic power in watts as explained in paragraph 2.3. For the example above, the 100 dB corresponds to an acoustic power of .01 W.

We can also use the equation to predict sound-pressure levels at any distance in the free field if we know the acoustic power radiated. Thus, this point source radiating .01 W, corresponding to a power level of 100 dB re 10^{-12} , produces a sound-pressure level of $100 - 20.5 = 79.5$ dB re 20 μ Pa at 10 ft from the source.

13.1.2 Directional Source in Free Field.

Directional Source. In actual practice, noise sources are not as simple as point sources. The sound is not radiated uniformly in all directions, either because the shape of the sound source is not spherical, or because the amplitude and time phase of the vibrations of the different parts are not uniform, or both. The net result is that more sound is radiated in some directions than in others.

Sound-Pressure Contours. In other words, the sound-pressure level for a given distance is different in different directions. As an example, let us observe the sound field surrounding a large 60-cycle power-distribution transformer, as shown in Figure 13-2. The contours around the transformer correspond to the indicated values of sound-pressure level. This source is obviously directional, since the contours are not circular.

When such a directional sound source is far from any other objects, however, it behaves in some ways like a point source. For example, the sound-pressure level decreases 6 dB for each doubling of distance, provided we start our measurements at a distance away from the source that is several times the largest dimension of the source, and provided we move directly away from the source. From the example of the transformer in Figure 13-2, we see that, at distances greater than several times the length of the transformer, the contours are similar in shape and the levels decrease approximately 6 dB for each doubling of distance. In actual practice this idealized behavior is upset by the effects of variation in terrain, atmospheric conditions, and the interference of nearby objects.

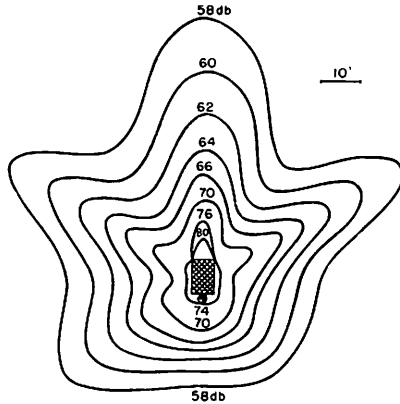

Figure 13-2. Simplified contours of equal sound-pressure level around a large power-distribution transformer.

Near Field and Far Field. We can also see that at locations close to the transformer the sound-level contours are different in shape from those at a distance. Furthermore, there is no apparent center from which one finds the 6-dB drop for each doubling of distance. Consequently, this “near-field” behavior cannot readily be used to predict the behavior at a distance. The differences between the near field and “far field” can be described in part as follows: Assume we have a source in which one part moves outwardly while another moves inwardly and vice versa. The air pushed away by one part will then tend to move over to compensate for the decrease in air pressure at the inward moving part. If the air can move over quickly enough, there will be considerable motion of air between the two parts, without contributing much to radiation of sound away from the source. The time factor in this motion of air can be expressed as a relation between the distance to be covered and the wavelength of the sound in air. The wavelength, λ , at normal temperature is as follows:

$$\lambda \approx \frac{1130}{f} \text{ ft} \approx \frac{344}{f} \text{ meters}$$

where f is the frequency in hertz and 1130 f/s (or 344 m/s) is the speed of sound (see Table 13-1). Then, in order that the near field effect should not be very im-

portant, one should be at least one wavelength away from the source. This dimension should be determined on the basis of the lowest frequency of interest. For the example of the 60-Hz transformer, the lowest frequency of sound is 120 Hz, which corresponds to a wavelength of about 10 ft or 2.9 m.

Another factor that enters into the differences between the near field and far field behavior is the way the sound waves spread out from a source. The sound waves from a large source vary with distance differently from waves produced by a small source. But at a distance of several (3 to 4) times the largest dimension of the radiating source, "spherical spreading" is said to exist, and the behavior is then nearly independent of the size of the source.

The region where the size of the source determines the way sound waves spread is sometimes called the "geometric field." When there is a region where there is significant oscillation of air particles but no effective sound radiation, that region is sometimes called the "inertial field."

Table 13-1

| Frequency | | Wavelength | |
|-------------------|------|------------|------|
| $\frac{1}{3}$ oct | oct | meters | feet |
| Hz | Hz | | |
| 25 | | 13.7 | 44.8 |
| 31.6 | 31.6 | 10.9 | 35.6 |
| 40 | | 8.6 | 28.3 |
| 50 | | 6.9 | 22.5 |
| 63 | 63 | 5.4 | 17.9 |
| 80 | | 4.3 | 14.2 |
| 100 | | 3.4 | 11.3 |
| 125 | 125 | 2.7 | 8.9 |
| 160 | | 2.17 | 7.1 |
| 200 | | 1.72 | 5.65 |
| 250 | 250 | 1.37 | 4.48 |
| 316 | | 1.09 | 3.56 |
| 400 | | .86 | 2.83 |
| 500 | 500 | .69 | 2.25 |
| 630 | | .54 | 1.79 |
| 800 | | .43 | 1.42 |
| 1000 | 1000 | .34 | 1.13 |
| 1250 | | .27 | .89 |
| 1600 | | .22 | .71 |
| 2000 | 2000 | .17 | .56 |
| 2500 | | .13 | .45 |
| 3200 | | .11 | .36 |
| 4000 | 4000 | .086 | .28 |
| 5000 | | .069 | .22 |
| 6400 | | .054 | .18 |
| 8000 | 8000 | .043 | .14 |
| 10000 | | .034 | .11 |

◆ *Directivity Factor.* When we are interested in sound-pressure levels beyond the immediate vicinity of the source, any sound can be treated as a point source, provided we introduce a directivity factor. This factor takes into account the variation in sound-pressure level with direction to the source. This directivity factor, which is a function of direction and frequency, is usually labeled Q . It can be expressed as the ratio of two acoustic powers. One of these powers is that which would be radiated by a point source, in order to produce the observed sound-pressure level in the specified direction. The other power is the total acoustic power radiated by the actual source.

◆ *Sound-Pressure Level for a Directional Source.* When we know this directivity factor for the direction of interest, we can use it, in the earlier equation for a point source, as a multiplying factor on the power. Expressed in terms of level the new equation is as follows:

$$L_p = L_w + 10 \log Q - 20 \log r - 0.5 \text{ dB.}$$

This equation relates the power level of the source, the sound-pressure level in a given direction at a distance r feet from the source, and the directivity factor for that direction. (This equation is also subject to the minor corrections for temperature and pressure shown in Figure 13-1). If r is in meters, the equation is

$$L_p = L_w + 10 \log Q - 20 \log r - 10.82 \text{ dB.}$$

For example, let us assume that an auto horn whose measured power level is 104 dB is sounded. We are interested in the sound-pressure level at a distance of 20 ft in the horizontal plane of the horn, but at an angle of 20° from the principle axis of the horn. Along this direction of 20° from the axis the directivity factor is 5, say. Then we have

$$L_p = 104 + 10 \log 5 - 20 \log 20 - 0.5 = 84.5 \text{ dB}$$

at 20 ft in the required direction.

13.1.3 Simulated Free Field. The free-field condition does not occur in practice, because of the effects of sound reflected from the ground or floor, from nearby objects, and from walls and ceiling. The result of these reflections is that the sound-pressure level measured at a distance from the source is different from that predicted by the free-field equations. The reflections can be reduced by acoustic absorbing materials applied to the reflecting surfaces. By the proper design and application of this treatment, one can produce in a room a limited space having the essential characteristics of a free field over a wide frequency range. Many such rooms, called “anechoic” or “free-field” rooms, have been built and are described in the literature. When accurate measurements of the radiated sound power and directivity are required, the measurements should be made in such an environment.

13.1.4 Effect of Reflections in a Room. The sound that a noise source radiates in a room is reflected by the walls, floor, and ceiling. The reflected sound will again be reflected when it strikes another boundary, with some absorption of energy at each reflection. The net result is that the intensity of the sound is different from what it would be if these reflecting surfaces were not there.

Close to the source of sound there is little effect from these reflections, since the direct sound dominates. But far from the source, unless the boundaries are very absorbing, the reflected sound dominates, and this region is called the reverberant field. The sound-pressure level in this region depends on the acoustic power radiated, the size of the room, and the acoustic absorption characteristics of the materials in the room. These factors and the directivity characteristics of the source also determine the region over which the transition between reverberant and direct sound occurs.

A second effect of reflected sound is that measured sound does not necessarily decrease steadily as the measuring position is moved away from the source. At certain frequencies in a room with hard walls, marked patterns of variations of sound pressure with position can be observed. Variations of up to 10 dB are common and, in particular situations, much more can be found. These variations are usually of the following form: As the measuring microphone is moved away from the source, the measured sound pressure decreases to a minimum, rises again to a maximum, decreases to a minimum again, etc. These patterns are called standing waves. They are noticeable mainly when the sound source has strong frequency components in the vicinity of one of the very many possible resonances of the room. They also are more likely to be observed when a frequency analysis is made; and the narrower the bandwidth of the analyzer, the more marked these variations will be.

In a room, the spacing from one minimum in sound pressure to another is on the average greater than one-half wavelength.

Reverberation Room. If a room has very little sound absorption, the room is said to be “live” or reverberant. Sound from a source in such a room will be reflected many times, as it bounces back and forth on the surfaces of the room. At any one point in this room the sound will have arrived there from many directions because of the many reflections. If the room dimensions are properly proportioned and certain other design features are included, the flow of sound energy in all directions can be made nearly equally probable, and the field is then said to be diffuse. This type of room is called a reverberation room, and it is widely used for the measurement of the sound-absorption of materials, as well as for sound-power measurements, when the directivity characteristics are not required.

Ordinary rooms. The sound field in an ordinary room cannot be described in detail. The acoustical boundary conditions of ordinary rooms are extraordinarily complicated, and most sound sources are also complicated. The result of this complexity is that one can attempt only an average-type of description. Even a rough approximation can be useful, however, and we shall review briefly some of the work on room characteristics as it applies to the sound produced by a source in a room.

◆ *Room Constant.* In order to simplify the analysis of the effect of the room, it is assumed that enough measurements are made so that any standing-wave patterns can be averaged out. A number of other assumptions are made, and then a relation of the form shown can be developed (Beranek, 1954; Hopkins and Stryker, 1948). Thus,

$$L_p = L_w + 10 \log \left[\frac{Q}{4\pi r^2} + \frac{4}{R} \right] + 10.5$$

where the new symbol R is the room constant, and the dimensions are in ft and ft². The corresponding equation in metric units is

$$L_p = L_w + 10 \log \left[\frac{Q}{4\pi r^2} + \frac{4}{R} \right] + 0.2$$

The room constant is defined by the equation:

$$R = \frac{\alpha S}{1 - \alpha}$$

where S is the total area of the bounding surfaces of the room and α is the average absorption coefficient of the surfaces of the room at a given frequency.*

Since most rooms are not uniform in surface conditions, the value for αS is obtained by adding the absorptions for the individual areas. Thus, for a simple example, we have most of the wall area and all of the ceiling treated with 900 square feet of acoustical material of a particular type that has a coefficient of absorption of 0.70 at 500 Hz (one of the standard test frequencies). The rest of the walls are 300 square feet of 1/2-inch gypsum board on 2x4's ($\alpha = .05$). the floor is 400 square feet of concrete ($\alpha = .016$). The total absorption is then as follows: $\alpha S = 0.70 \times 900 + .05 \times 300 + .016 \times 400 = 651$ absorption units at 500 Hz. If people and furniture are also present, the appropriate absorption units should be added to the room absorption to obtain the total absorption. The average value for the absorption coefficient is then obtained by dividing the total absorption by the total surface area. In the above example we have:

$$\alpha = \frac{\alpha S}{S} = \frac{651}{1600} = 0.41$$

The corresponding room constant is

$$R = \frac{\alpha S}{1 - \alpha} = \frac{651}{1 - 0.41} = 1100 \text{ ft.}^2$$

At frequencies above about 2000 Hz, the sound absorption in the air in a very large room is often enough to affect the room constant appreciably. This absorption increases with frequency, and it varies markedly with humidity and temperature. The absorption at normal room temperatures is a maximum at relative humidities in the range of 10 to 30%. As an example of the extent of the effect, assume we have a room having a volume of 250,000 cubic feet. Then at 6000 Hz, air absorption alone could produce a room constant of up to about 10,000 square feet. Since the effective room constant thus produced varies approximately as the volume of the room, the effect in small, treated rooms is usually negligible.

The relation given above is shown graphically in Figures 13-3 and 13-4, where Figure 13-3 applies to the nondirectional or simple source or to a directional

*Tables of values of absorption coefficients are given in *Compendium of Materials for Noise Control*, US Dept of HEW, NIOSH, Govt Printing Office, Washington, D.C. and in books on architectural acoustics.

source in the direction having a directivity factor of 1 ($Q=1$), and Figure 13-4 applies to the directions having the labeled values of directivity factor.

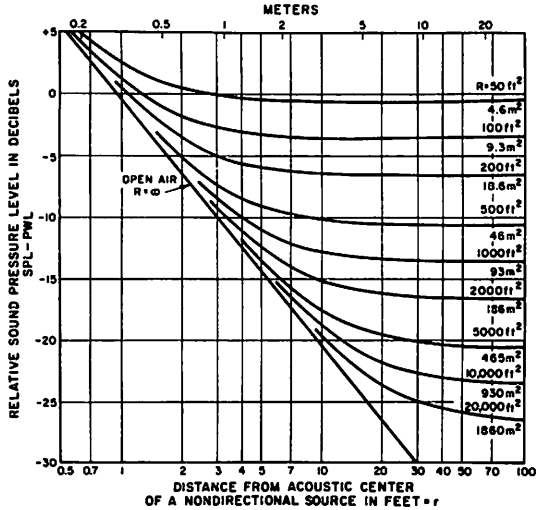

Figure 13-3. Chart showing the sound-pressure level, L_p , relative to the power level, L_w , for a nondirectional source for different values of the room constant, R , as a function of the distance from the source.

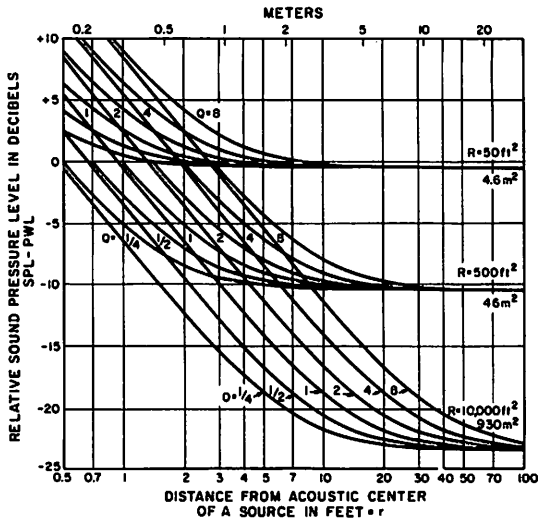

Figure 13-4. Chart showing the sound pressure level, L_p , relative to the power level, L_w , for a directional source as a function of the distance from the source. The relation is shown for three different values of the room constant, R , and for six different values of the directivity factor Q .

◆ **Reverberant Field.** The graphs of Figure 13-3 and 13-4 show that close to the source the sound-pressure level tends to vary with the distance from the source as it does under free-field conditions ($R = \infty$). But far from the source the sound-pressure level becomes independent of the directivity and the distance to the source. This region is called the reverberant field. Here, the level is determined by

the acoustic power radiated by the source and the acoustic characteristics of the room. The region over which the transition between the free-field behavior and the reverberant field occurs is determined by the directivity factor and the room constant.

Actual Room Behavior. In a well-designed reverberation room, the behavior on the average is similar to that shown in the figures. Most other rooms have characteristics that on the average fall between that reverberant behavior and the free-field sound-pressure level decrease of 6 dB for each doubling of the distance (Sabine, 1957; Ogawa, 1965; Gober and Lubcke, 1966; Yamamoto, 1961; Peutz, 1968).

In flat rooms (i.e., rooms whose ceilings are low relative to room length and width), the sound-pressure level at a distance from the source tends to decrease a fixed amount, but less than 6 dB, for each doubling of distance. The decrease depends on the sound absorption in the room. In very long rooms or halls, the sound-pressure level tends to decrease a fixed number of decibels for a constant increment in the distance from the source.

In the vicinity of local obstructions and other areas with marked changes in acoustic characteristics, the sound-pressure level can change markedly.

In order to illustrate one of these effects, we shall reproduce a set of measurements made on a rectangular studio with an acoustic noise source covering the range from 300 to 600 Hz (Ogawa, 1965). The studio was 13.5 m by 24 m by 4.2 m and the average absorption coefficient at 500 Hz was 0.25. The room constant is then about 320 m² or about 3400 ft². Figure 13-5 shows the result of measurements in this room. The crosses are the observed sound-pressure levels and the smooth curve is plotted to correspond with the room-constant.

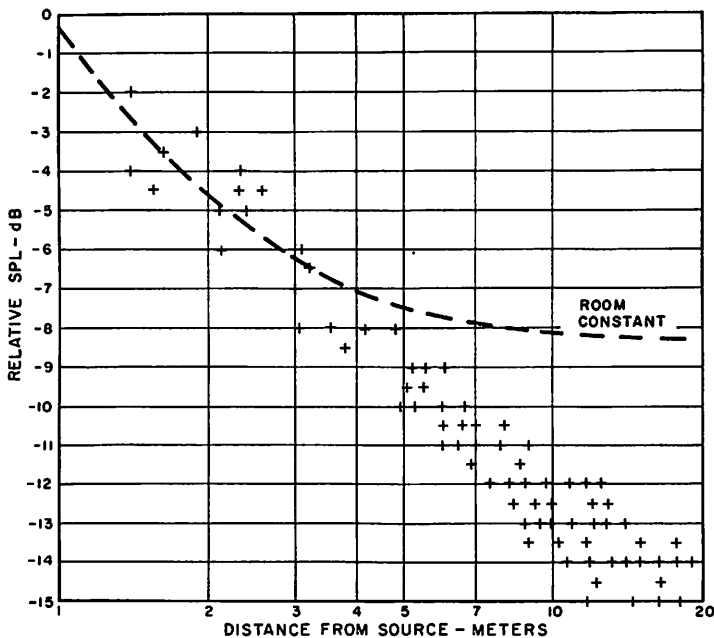

Figure 13-5. Plot of actual measurements made in a room with an absorption coefficient of 0.25 vs calculated performance (dashed line). (Ogawa, 1965.)

The calculations from the simple formula tend to overestimate the level at a considerable distance from the source. The average trend of the sound-pressure level is a drop of about 3.5 dB for a doubling of the distance. The marked departure from the behavior expected, on the basis of the simple formula, is a result of the fact that the average absorption was relatively high and the height was relatively low compared to the other dimensions, but it is similar in shape to that of many large, general, office areas.

Much more complicated formulas can yield values in closer agreement with the measurements, but the calculations become impractically tedious unless they are programmed on a computer. The simple formula is still useful for a preliminary estimate of the expected behavior, particularly if the absorption is small and if no one room dimension is markedly different from the others.

13.2 MEASUREMENT OF SOUND NEAR A SOURCE

Many devices are rated for noise by specifying the A-weighted level at a distance of 1 meter from a major surface of the device. Or an octave-band analysis of the noise at a specified location may be given. This information is useful, but, as explained later, an acoustic power rating may be even more useful. Because the simple rating at a given distance is commonly used, it will be reviewed briefly before acoustic power measurements are discussed.

The device to be measured may be suspended or mounted in an anechoic room (see paragraph 13.1.3), it may be mounted on a concrete slab that forms the floor of an otherwise anechoic room, or it may be set up to operate under conditions that closely approximate those normally encountered in use. The measurement microphone is frequently set at a series of positions around the device, spaced 1 meter from the major surfaces of the device. At each of these positions the sound field may be explored by moving the microphone about but at the fixed 1-meter distance to obtain a representative average value. The observer should not be close to the microphone or the device when the measurement is made. Preferably, the observer and all extraneous equipment should be several meters distant from the microphone and the device.

13.3 EFFECT OF BACKGROUND NOISE

Ideally, when a noise source is measured, the measurement should determine only the direct air-borne sound from the source, without any appreciable contribution from noise produced by other sources. In order to ensure isolation from other sources, the measurement room may need to be isolated from external noise and vibration. As a test to determine that this requirement has been met, the American National Standard Method for the Physical Measurement of Sound, S1.2, specifies the following:

"If the increase in the sound pressure level in any given band, with the sound source operating, compared to the ambient sound pressure level alone, is 10 dB or more, the sound pressure level due to both the sound source and ambient sound is essentially the sound pressure level due to the sound source. This is the preferred criterion."

When apparatus noise is analyzed, the background noise level in each band should also be analyzed to determine if the difference in band levels for the total noise and background is greater than 10 dB. The spectrum of the background noise is usually different from that of the noise to be measured.

If this difference between total noise level and background level is less than 10 dB, an attempt should be made to lower the background level. Usually the first

step is to work on the source or sources of this background noise to reduce the noise directly (see Chapter 16). The second step is to work on the transmission path between the source and the point of measurement. This step may mean simply closing doors and windows, if the interfering source is external to the room, or it may mean erecting barriers, applying acoustical treatment to the room, and opening doors and windows, if the source is in the room. The third step is to improve the difference by the method of measurement. It may be possible to select a point closer to the apparatus, or an exploration of the background noise field may show that the measuring position can be shifted to a minimum of this noise. The latter possibility is more likely when an analysis is being made and the background level in a particular band is unusually high.

If the background noise level and the apparatus noise level are steady, a correction is often applied to the measured data according to the graph of Figure 13-6. The procedure is as follows: After the test position has been selected according to the test code, the background noise level is measured in the test position. Then the sound level is measured with the apparatus operating. The difference between the sound level with the apparatus operating and the background level determines the correction to be used. If the difference is greater than 10 dB, the background noise has virtually no effect, and the reading with the apparatus operating is the desired level. An example of a situation intermediate between these two is as follows: The background noise level is 77.5 dB, and the total noise with the machine under test operating is 83.5 dB. The correction, from the graph of Figure 13-6, for a 6.0-dB difference, is 1.2 dB, so that the corrected level is 82.3 dB.

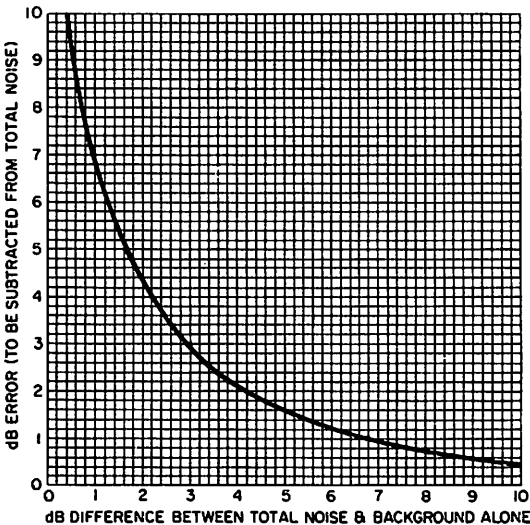

Figure 13-6. Background noise correction for sound-level measurements.

Any significant correction according to this procedure should be noted in the record of the measurement. This correction reduces the reliability of the estimate of the device noise level (Peterson, 1977). When the correction is large, the corrected level can be so unreliable as to be seriously misleading. Then it is frequently better to use the total level as an upper bound to the device noise level rather than to place any reliance on a corrected level.

When a comparison method is used (see paragraph 13.4) particular care should be taken that the background noise level be much lower than any of the total measurements. The fact that the result is already a difference of two measured (estimated) levels each with some uncertainty, leads to an appreciably less reliable estimate of the result (Peterson, 1977). Any correction for background noise will increase the uncertainty even more.

13.4 MEASUREMENT OF ACOUSTIC POWER

A noise rating is often intended to make possible the prediction of the noise level that the apparatus will produce when installed. In order for the rating to be adequate for this purpose, the total acoustic power radiated by the source and the acoustic directivity pattern of the source should be included as part of the rating. We shall explain in this section how the power and directivity can be determined, but first we shall discuss the limitations of the usual method of noise rating.

For example, an air compressor may be rated by the manufacturer as producing a noise level of 85 dB at a distance of 5 ft. This level may have been calculated by an averaging of a few sound-level readings 5 ft from the compressor. When it is installed and the level is measured, the new level may be, say, 90 dB at 5 ft. Naturally, the purchaser feels that he should complain because the machine was incorrectly rated; perhaps he returns the compressor, or he decides that he can no longer trust the manufacturer. Actually, the manufacturer may have been entirely correct in his noise measurements, but the rating was inadequate. The difference of 5 dB may have been caused by incorrect installation, but usually such a difference is a result of the acoustical characteristics of the factory space. By the use of an adequate rating system and a knowledge of acoustical room characteristics, it would have been possible to predict this effect.

Another part of this problem is the prediction of levels at places in the factory other than at the measurement distance. For example, the nearest worker may be 20 ft away, and the level at a distance of 20 ft is then more important than at 5 ft. Again, a knowledge of the acoustic power radiated and the acoustical characteristics of the factory space will be needed to predict the probable level at this distance.

The procedure suggested here for determining the power and directivity is based on measurements of the sound-pressure level at a number of points around the noise source. The measurement of sound-pressure level has already been discussed. We shall discuss here the selection of the points at which to measure the sound-pressure levels, the method of calculating acoustic power, and the requirements on the characteristics of the space in which the measurement is to be made.

Four different types of environment are considered in the discussion of sound-power measurements, that is, free field or anechoic, free-field above a reflecting plane, reverberation room, and a semireverberant field. The choice among these is determined by many factors, most of which will become evident from the descriptions that follow. The influence of development in instrumentation are not described in the procedures, but they need to be considered also. In particular, the fewer microphone positions required for the reverberant room measurement is no longer as significant a factor as it was. The technique for cumulatively summing on a pressure-squared basis, as provided by the 1995 Integrating Real-Time Analyzer, now simplifies the anechoic measurement or the free-field measurement above the reflecting plane to the point that their other advantages make them more attractive than formerly.

The procedures used for measuring acoustic power, particularly in a reverberant room, have been extensively developed in the past few years. Now many standards are available for a wide variety of devices. It is impractical to include all of them here, and therefore only the general principles will be reviewed. Anyone who needs to measure acoustic power should follow the details in the standard most appropriate for his device.

◆ *Measurement Procedures.* The source characteristics are obtained by use of the principles discussed earlier in this chapter.* Generally, the following characteristics must be determined:

1. The total sound power radiated by the source, as expressed by the power level, as a function of frequency.
2. The directional characteristics of the source, as expressed by the directivity factor, as a function of direction and frequency.

◆ *Measurements Around the Source.* If free-field conditions can be closely approximated, the power level and directivity can be calculated from the sound-pressure levels measured at a number of points. These measurements are made at points at equal distances from the source and all around the source. The points can be considered as being on the surface of a hypothetical sphere surrounding the source. The radius of this sphere should be at least twice the largest dimension of the source but not less than 2 ft (0.6m).

If the equivalent of a free field is produced by extensive treatment of the surfaces of a room, the hypothetical measurement sphere should not be closer to the absorbent surfaces than $\frac{1}{4}$ wavelength corresponding to the center frequency of the lowest frequency band of interest. Since anechoic chambers built with wedges have the wedges about one-fourth wavelength long at the lowest frequency of interest, one can readily estimate the minimum dimensions for an anechoic chamber. For a noise source less than a foot in maximum dimension, the wall-to-wall inside distance should then be at least one wavelength plus 4 ft (1.2 m). The following table gives this value for some limiting frequencies.

| <u>f</u> (Hz) | <u>$\lambda + 4$</u> (ft) | <u>$\lambda + 1.2$</u> (m) |
|------------------|---|--|
| 100 | 15.3 | 4.6 |
| 125 | 13.0 | 4 |
| 160 | 11.1 | 3.4 |
| 200 | 9.6 | 2.9 |

Theoretically, the sound-pressure levels over the entire surface of the sphere should be measured. The practical procedure for approximating this exploration is to select a number of points at which measurements will be made. Areas on the sphere are then associated with these points. These areas have the measurement points as their centers, and the extent of each area is determined by the nearness of the other measuring points. In the process of making the basic measurements, the microphone should be moved around to determine the variation in sound-pressure level within each area. If the variations in sound-pressure level within any one area are greater than 2 dB, it is advisable to select additional measuring points in that area. However, if no attempt is being made to obtain an accurate picture of the directivity pattern, the extent of the variation can be noted. Then, provided the variation is less than 6 dB, the average level can be used as a representative value for the area.

*The procedures outlined here and in subsequent sections are similar to those given in ANSI S1.2-1962, "Standard Method for the Physical Measurement of Sound," and that should be consulted for specific details on the standard method.

Uniformly Distributed Measuring Points. The calculations for the radiated power are simplified if the measuring points are uniformly distributed on the surface of the sphere. Because of the nature of the geometric pattern, only six such sets of points are possible. These six sets have 2, 4, 6, 8, 12, and 20 uniformly distributed points. The locations for the sets of 8, 12, and 20 points are shown in Figures 13-7 through 13-9. These are now generally used, although a different orientation with respect to the ground plane may be found desirable for some particular applications. The areas associated with the sets of 8, 12, and 20 points are regular spherical triangles, regular spherical pentagons, and regular spherical triangles, respectively.

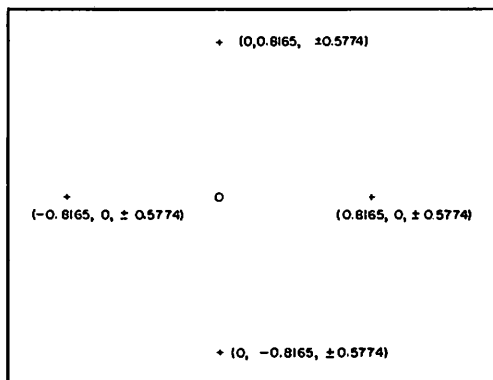

Figure 13-7. Plan view of eight points uniformly distributed on a sphere of unit radius. Coordinates are given in terms of distances from center along three mutually perpendicular axes (x, y, z). The “ \pm ” refers to the existence of two points, one above the x - y reference plane and one below. When measurements are to be made on a hemisphere, only the four points above the plane are used.

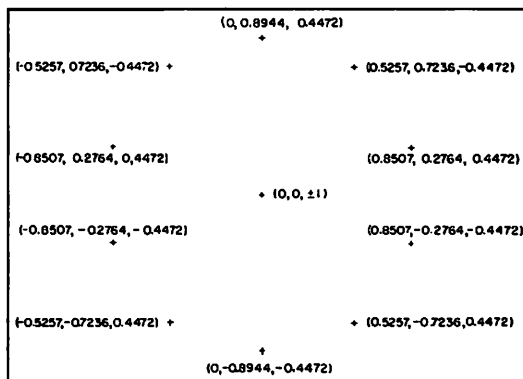

Figure 13-8. Plan view of 12 points uniformly distributed on a sphere of unit radius. Coordinates are given as in the previous figure. When measurements are to be made on a hemisphere, only the six points above the x - y reference plane (positive values of z) are used.

Other sets of points that may be useful are those that correspond to the vertices of an Archimedean semiregular polyhedron. The most interesting of these have 24 (R.M. Robinson, 1961), 48, and 60 points. Although these points are not uniformly distributed, they are all of equal importance, because the distribution of points around any one point is the same for all points.

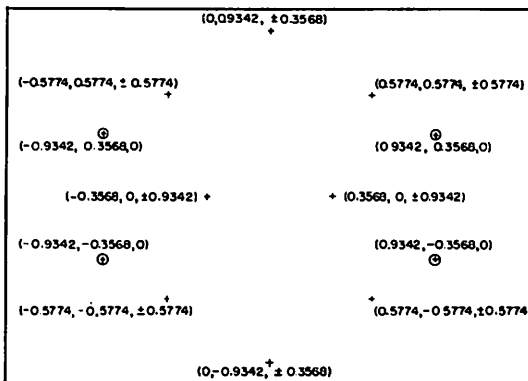

Figure 13-9. Plan view of 20 points uniformly distributed on a sphere of unit radius. Coordinates are given as in Figure 13-7. When measurements are to be made on a hemisphere, 12 points are used, eight above the reference plane and four in the plane ($z=0$, shown encircled). The four in the plane are weighted by a factor of $1/2$ in power (see text).

◆ *Hemispherical Measurements.* When the device to be tested is normally mounted on a concrete foundation, on the ground, or on a wall, it is often desirable to test it while it is so mounted. The environment that approximates this is a free field above a flat, hard reflecting plane. This can be an open paved area outdoors that is far from any other obstructions, or it can be an otherwise anechoic chamber with a hard floor or wall.

The sound-pressure level measurements should be made at points on a hypothetical hemisphere surrounding the source. The sets of points that lead to simple calculations of power level are now modified. A set of 4 points (half the set of 8) can be properly used, and a set of 6 points (half the set of 12) can be used even though the distribution is not exactly uniform. A set of 12 can also be used, but then 4 of the set must be weighted by a factor of one-half (or, 3 dB is subtracted from the levels at these four points). See Figure 13-9.

The reflecting plane affects the sound-radiation characteristics of the source (ANSI S1.2-1962; Baade, 1964; Ellison et al., 1969). The near-field conditions are extended and the directivity pattern is more complex, compared with the conditions of the same source in a free field. Because of these effects, the hypothetical test hemisphere centered about the source should have a radius at least twice the average distance of the source from the reflecting plane, but not less than twice the maximum dimension of the source or 2 ft (0.6 meter).

The reflecting plane should extend beyond the farthest microphone position a distance at least one wavelength that corresponds to the center frequency of the lowest frequency band to be used. The effects of other obstacles and reflecting surfaces should be minimized by keeping them away from the source and the microphone positions.

Because the reflecting plane introduces a plane of symmetry, the measuring points that are at equal heights above that plane have some redundancy. This redundancy makes them less useful for providing a good space-average sound-pressure level than for the same number of points with no two of them at the same height. A double rotation of the set of 20 points of Figure 13-9 makes it possible to produce such a set of 10 for the hemisphere, and a representative set of coordinates is given in Figure 13-10. This set of points is not included in the standard.

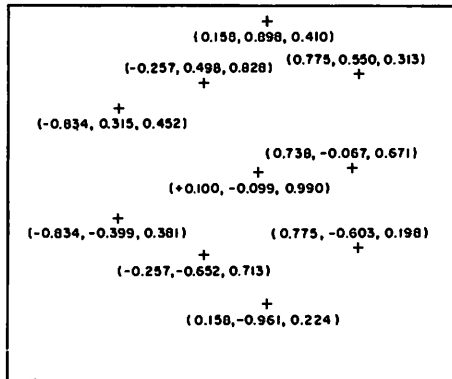

Figure 13-10. Plan view of 10 points distributed on a hemisphere of unit radius.

When the hemisphere is used, the procedure for calculating power is the same as that described for the sphere. But 3 dB should be subtracted from the power level finally obtained, because the area of the hemisphere is just one-half that of the sphere.

◆ *Rotation of Source.* Another way of simplifying the calculations is to rotate the source, with the microphones placed on the surface of a hypothetical sphere surrounding the source, so that the projections of their positions on the axis of rotation are uniformly distributed. A variation of this method, practiced by the Bell Telephone Laboratories (Jenkins, 1954), calls for the rotation of a set of microphones about a stationary source.

◆ *Calculation of Power Level.* If exploration shows that the basic set of points yields representative data, calculations of the power level and directivity factor can be made. For a uniformly distributed set of points, first calculate the average level on a power basis. If the total range of sound-pressure levels is less than 6 dB, a simple arithmetical average is usually adequate. The accurate method for any situation is as follows: Convert the decibel readings at each of the points of measurement to power ratios by using the tables in the Appendix, add these power ratios, and convert back to a decibel level. Then, subtract the decibel value corresponding to a power ratio numerically equal to the number of levels used (for 8, 12, and 20 readings subtract 9, 10.8, and 13 dB, respectively). The result is then the average level, which we shall call L_p . Provided free-field conditions exist, the power level is then calculated from the equation:

$$L_w = L_p + 20 \log r + 10.8 \text{ db}$$

where r is the radius of the measuring sphere, in meters, or

$$L_w = L_p + 20 \log r + 0.5 \text{ dB}$$

where r is the radius of the measuring sphere, in feet. When the rotating source or rotating microphones are used, the average energy during a complete rotation as well as for all the microphones should be taken, and the corresponding average sound-pressure level used in the above formula.

◆ *Calculation of Directivity Factor.* After the average sound-pressure level, L_p , has been determined, the directivity factor can also be calculated. If it is desired for a particular direction, the sound-pressure level on the measuring sphere corresponding to that direction, L_{p1} , is measured. The difference between this level and the average level is called the directional gain, DG_1 . Thus,

$$DG_1 = L_{p1} - L_p \text{ dB}$$

To determine the directivity factor, Q , convert the DG_1 value in decibels into a power ratio by using the decibel tables in the Appendix. Thus, a directional gain of -2 dB corresponds to a directivity factor of 0.63.

Effect of Room on Measurements. The space in which power level and directivity are to be determined must be carefully considered. As explained previously, the measurement should ordinarily be made in an anechoic chamber. Sometimes the measurement can be made outdoors, far from other objects. If the device under test is normally mounted on the ground, this outdoor measurement may be ideal, provided that the location is free from interfering objects and the background noise level is low enough.

◆ *Requirements on Room Characteristics.* If the measurement is to be made in a room, it should be a large room, with extensive acoustic treatment. Large acoustic absorption is particularly important if the directivity characteristics must be accurately determined. In order to obtain satisfactory results in moderate-sized rooms, extraordinarily good acoustic treatment must be used. Many of these special anechoic chambers have been built.*

◆ *Sound Source in a Reverberant Room.* All sources that radiate sound as discrete tones, or as very narrow-band components, and all sources whose directivity must be determined, should be measured by the above free-field procedure. The total power radiated by a source, whose sound energy is distributed over a wide band of frequencies, can, however, be determined in a reverberant room — that is, a room with hard walls, floor, and ceiling.

If the reverberant space satisfies certain requirements, some sources with discrete tones can be measured in such a space. The procedures for showing that a particular reverberant room qualifies for measuring such sources are complicated and time consuming (see Baade, 1976; ANSI S1.2-1972; and the September-October 1976 issue of *Noise Control Engineering*). If such a facility is to be developed, an experienced acoustical engineer should be consulted for the design, testing, and final adjustment of the reverberation room. Since the design and testing is highly specialized, it will not be reviewed here. Rather, some of the requirements for the measurement of broad-band noise sources will be discussed, and occasional remarks about the requirements for measurement of narrow band sources will be included.

◆ *Measurements in a Reverberant Room.* In a reverberant room, sound power can be determined from measurements of average sound pressure in the room and of the total absorption. The absorption is determined from a measurement of the rate at which a transient sound in the room decays. The procedure is as follows:

*Anechoic chambers of various sizes are manufactured by, for example, the Eckel Corporation, 155 Fawcett Street, Cambridge, Mass.

The sound source in the room is turned on and the sound is allowed to reach a steady value. The sound is picked up by the microphone of a sound-level meter whose output is recorded on a graphic-level recorder. The sound source is abruptly turned off, the sound in the room decays, and this decay is plotted by the graphic level recorder. The slope of the decay curve, in dB per second, is the rate of decay, D (see ASTM C423-77).

For a highly reverberant room, that is, where D is small (say 50 dB/s or less), the sound power level of the source is then given by the following expression.*

$$L_w = L_p + 10 \log V + 10 \log D - 30.8$$

where V is the volume of the room in cubic meters and L_p is the average sound-pressure level in the reverberant field. The numerical value of 30.8 in the above formula varies with atmospheric pressure, as shown in Figure 13-11. For most measurements at sea level the value of 30.8 can be used.

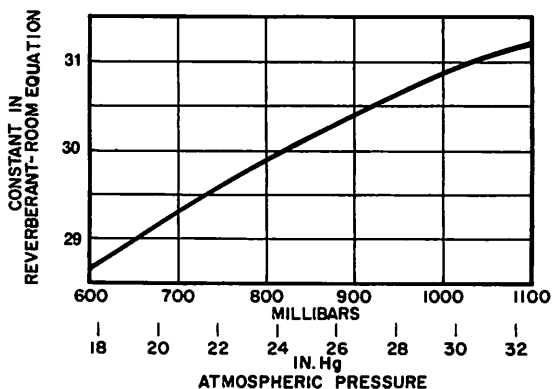

Figure 13-11. Variation of numerical constant in the equation relating power level and sound-pressure level for a reverberant room.

♦ **Room Requirements.** In order for the measurement to be useful, the room must satisfy the following conditions:

1. If the source has a broad spectrum and the measurements are made in octave bands, the smallest dimension of the room should be at least equal to a wavelength at the center frequency of the lowest octave band of interest. If discrete components are included, the smallest dimension should be at least equal to 1.25 times a wavelength at the center frequency of the lowest octave band of interest. Volumes between 70 m³ and 300 m³ are appropriate for measurements from 100 Hz to 10 kHz. The source volume should be less than 1% of the volume of the room.
2. No two dimensions of the room should be alike or have a ratio that is an integer. A ratio of 1 : $\sqrt{2}$: $\sqrt{4}$ for the height, width, and length is often recommended.**
3. The floor of the test room should have a Sabine absorption coefficient less than .06. The walls and ceiling can have slightly more absorption. A recent proposal specifies a reverberation time between 0.5 and 1 second (decay rates of 120 to 60 dB/sec), with the time following a prescribed curve, being highest at the lowest frequency. Such decay rates would require an average absorption coefficient significantly greater than .06.

*The various standards now available from ANSI and ISO on acoustic power measurements should be consulted for the details of making an acceptable measurement. See the list of standards in Appendix VII.

**Suggested ratios of length to width to height are given in ANSI S1.21 as 1: .83: .47, 1: .83: .65, 1: .79: .63, 1: .68: .42, or 1: .70: .59.

◆ *Source location.* The source should be mounted in one or more locations that represent normal usage, for example, on the floor. But it should be at least 1 meter from the other surfaces with which it is not normally associated. It should not be in the middle of the room, and no major surface of the device should be parallel to a wall.

◆ *Sampling and Averaging Procedure.* The desired sound-pressure level is an average taken at several positions about the source, but at a distance from the source at least equal to the largest dimension of the source and yet not closer to any wall than $\frac{1}{4}$ wavelength. The measurement positions should also be at least $\frac{1}{2}$ wavelength apart. The average sound-pressure level should be determined on an energy basis.

In order to measure the room characteristics, the decay rates at the same set of measurement positions should be averaged for each measured band. If the ultimate measurements are to be in octave bands, an octave-band noise source should be used; for instance, a random-noise generator, filtered by an octave-band analyzer, driving an amplifier and loudspeaker may be used as the source. The decay rate for a given set of room conditions will remain constant over a considerable time, except at the high audio frequencies where air absorption is critically dependent on relative humidity.

In a well-designed reverberation room, fewer measurement points are needed than for the free-field measurements. Six or twelve are commonly chosen. If the source is not highly directional, and if large rotating vanes are used to alter the standing-wave pattern during the measurement, three microphone positions may be adequate for the measurement. The rotating vanes in effect lead to an average of the sound-pressure level over a large area. So few microphone positions are not recommended, however, unless extensive experience has shown that the results are the same as those obtained with many microphone positions. (Lubman, 1968). The use of several source positions also helps to produce a better average.

Another method of exploring the sound field to obtain an average is to swing the microphone around a wide area, but it is not as efficient as discrete widely spaced microphones (Waterhouse and Lubman, 1970). Still another method is to rotate the source.

The 1995 Real-Time Analyzer with its true mean-square integrating detector is ideal in providing the average level in this application.

Comparison Method. The procedures given above require special rooms for the measurement of radiated power. When such measurements must be made in an ordinary room, a different technique has been proposed by Hardy, Wiener, Wells, and others. This is a comparison method, in which a standard source similar to that to be measured is used as a reference. The radiated power of this standard source must have been determined by one of the preceding techniques.

Measurement Procedure. The measurement procedure is as follows:

- a. The standard source is turned on in the room. Sound-pressure level is measured at several places around the source at a distance from the source equal to at least the maximum dimension of the source. The measurements are usually made in octave bands. The measured levels are averaged on an energy basis for each band.
- b. The unknown source is operated in place of the standard source. The sound-pressure levels are measured at the same points as before and averaged for each octave band.
- c. For each octave band the difference in average level, between the standard and the unknown, is applied to the known power level of the standard source.

Requirements for Standard Source. The standard source should produce a stable and reproducible sound. Such sources have been developed for the Compressed Air and Gas Institute and for the fan and blower industry (Hardy, 1959).

Requirements for Room. The measurement room should be large and its characteristics should approach those of a reverberant room. No obstructing object should be in the immediate vicinity of the source or the microphone positions.

13.4 SOURCE-MOUNTING

It is often noticed that the noise level produced by a machine is highly dependent on its mounting. A loose mounting may lead to loud rattles and buzzes, and contact to large resonant surfaces of wood or sheet metal may lead to a sounding-board emphasis of various noise components. For these reasons particular care should be given to the method of mounting. In general, the mounting should be as close to the method of final use as possible. If the machine is to be securely bolted to a heavy concrete floor, it should be tested that way. If the actual conditions of use cannot be duplicated, the noise measurements may not be sufficient to predict the expected behavior, because of the difference in transmission of noise energy through the supports. The usual alternative is to use a very resilient mounting, so that the transmission of energy to the support is negligible.

◆ 13.5 PREDICTING NOISE LEVELS

When the acoustic power output and the directivity pattern of a device are known, the noise levels that it will produce under a variety of conditions can be predicted (on the average) with fair accuracy. These predictions are based on the principles discussed earlier in this chapter.

If a noisy device is placed in a room that is not anechoic, it is desirable to measure the decay rate of sound, D , in the room; and then the following formula, adapted from one by Young, can be used to predict the average level of sound in that part of the room where the reverberant field dominates:

$$L_p = L_w - 10 \log V - 10 \log D + 30.8$$

where V is the volume of the room in cubic meters. L_w is the source power level and the constant 30.8 varies with atmospheric pressure (see Figure 13-11).

Close to the source, the level is almost as if free-field conditions existed. The level decreases with increasing distance from the source and the average approaches the reverberant field level. Here, standing waves will exist and it is only the average level that can ordinarily be predicted. At points less than $\frac{1}{4}$ wavelength from a hard wall, the level will be higher than the average in the reverberant field. Very near a hard wall the increase may be as much as 3 dB; very close to an edge, 6 dB; and right at the vertex of a corner, 9 dB (Waterhouse, 1958; Tickner, 1974).

When the decay rate in the room cannot be measured, it can be estimated from a detailed knowledge of the room and its surface conditions. The procedures are given in books on architectural acoustics. There the calculation procedure is normally given for reverberation time, T . The decay rate, D , is then easily obtained as follows:

$$D = \frac{60}{T}$$

A related procedure is to calculate the room constant, from the characteristics of the room. Then the equation given there can be used to estimate the sound-pressure level. The discussion in paragraph 13.1.4 should also be considered in order to modify the prediction to fit the actual conditions.

As described earlier, the near-field behavior of a source may not be closely related to the far-field behavior that constitutes the radiated sound power. As a result, a knowledge of the radiated sound power does not ensure that one can estimate reliably the level near a machine. When it is important to know the sound level very close to a machine, as is often the situation for noise-exposure measurements, the actual sound level should be measured at the desired point. As explained earlier, exploration is desirable here, because close to the machine the sound level may vary markedly with position.

The sound-pressure level produced by the source is also affected by its position in the room — that is, if it is suspended in the middle of the room, or mounted on the floor, wall, or ceiling, or in a corner. It is often very difficult to predict the exact effect, however (Waterhouse and Cook, 1965). Ordinarily the level is higher when the source is very near a hard surface than when it is in the middle of the room. If the source is generally mounted on a hard surface, it should be measured that way, so that the effect on the source is taken into account. Then the levels in another room can be predicted with better accuracy.

REFERENCES

Standards

- ANSI S1.2-1962 (R1976) Physical Measurement of Sound.
ANSI S1.13-1971 Measurement of Sound Pressure Levels.
ANSI S1.21-1972 Determination of Sound Power Levels of Small Sources in Reverberation Rooms.
ANSI S1.30-1979 Guidelines for the Use of Sound Power Standards and for the Preparation of Noise Test Codes.
ANSI S1.35-1979 Precision Methods for the Determination of Sound Power Levels of Noise Sources in Anechoic or Hemi-Anechoic Rooms.
ASTM C423-77 Methods of Test for Sound Absorption and Sound Absorption Coefficients by the Reverberation Room Method.
IEC 651-1979 Sound Level Meters.
ISO 3740-1978, Acoustics — Determination of Sound Power Levels of Noise Sources — Guidelines for the Use of Basic Standards and for the Preparation of Noise Test Codes.
ISO 3741-1975, Acoustics — Determination of Sound Power Levels of Noise Sources — Precision Methods for Broad-Band Sources in Reverberation Rooms.
ISO 3742-1975, Acoustics — Determination of Sound Power Levels of Noise Sources — Precision Methods for Discrete-Frequency and Narrow-Band Sources in Reverberation Rooms.
ISO 3743-1977, Acoustics — Determination of Sound Power Levels of Noise Sources — Engineering Methods for Special Reverberation Test Rooms.
ISO 3744-1978, Acoustics — Determination of Sound Power Levels of Noise Sources — Engineering Methods for Free-Field Conditions Over a Reflecting Plane.
ISO 3745-1977, Acoustics — Determination of Sound Power Levels of Noise Sources — Precision Methods for Anechoic and Semi-Anechoic Rooms.

Other

- S.L. Applegate and D.K. Nelson (1976), "Qualifications of Two 180 Cubic Meter Reverberation Rooms with Microphone Traversing and Low Frequency Absorbers," *Noise Control Engineering*, Vol 7, #2, Sept-Oct 1976, pp 105-109.
P.K. Baade (1976), "History of the Qualification Procedures of American National Standard S1.21-1972," *Noise Control Engineering*, Vol 7, #2, Sept-Oct 1976, pp 48-51.
P.K. Baade (1964), "Sound Radiation of Air-Conditioning Equipment; Measurement in the Free-Field Above a Reflecting Plane," *ASHRAE Trans*, Vol 70, pp. 217-227.
L.L. Beranek (1954), *Acoustics*, McGraw-Hill, New York, Part XXIV.
M.W. Blanck (1976), "Qualification of a 300 Cubic Meter Reverberation Room," *Noise Control Engineering*, Vol 7, #2, Sept-Oct 1976, pp 93-96.
A.J. Ellison, C.G. Moore, and S.J. Yang (1969), "Methods of Measurement of Acoustic Noise Radiated by an Electric Machine," *Proc Inst Electrical Eng*, Vol 116, #8, August, pp 1419-1430.
H.J. Gober and E. Lubcke (1966), "Sound Field in Very Wide and Long Rooms," *J Acoust Soc Am*, Vol 39, #6, June, p. 1266.

- H.C. Hardy (1959), "Standard Mechanical Noise Sources," *Noise Control*, Vol 5, #3, May, pp 22-25.
- R.P. Harmon (1976), "Development of an Acoustic Facility for Determination of Sound Power Emitted by Appliances," *Noise Control Engineering*, Vol 7, #2, Sept-Oct 1976, pp 110-114.
- C.I. Holmer and D. Lubman (1976), "Comparison of Microphone Traverse and Microphone Array for Determining Space Average Sound Pressure Level in a Reverberation Room," *Noise Control Engineering*, Vol 7, #2, Sept-Oct 1976, pp 64-70.
- C.I. Holmer (1976) "Qualification of an Acoustic Research Facility for Sound Power Determination," *Noise Control Engineering*, Vol 7, #2, Sept-Oct 1976, pp 87-92.
- H.F. Hopkins and N.R. Stryker (1948), "A Proposed Loudness-Efficiency Rating for Loudspeakers and the Determination of System Power Requirements for Enclosures," *Proc IRE*, Vol 36, #3, March, pp 315-355.
- R.T. Jenkins (1954), "A New Sound Integrator," *Bell Labs Record*, Vol 32, September, pp 331-335.
- V.O. Knudsen and C.M. Harris (1950), *Acoustical Designing in Architecture*, John Wiley & Sons, Inc., New York.
- D. Lubman (1968), "Fluctuations of Sound with Position in a Reverberant Room," *J Acoust Soc Am*, Vol 44, #6, December, pp 1491-1502.
- Y. Ogawa (1965), "The Applicable Limit of Beranek's Formula and Ishii's Formula of Sound Pressure Level Distribution in a Room," *J Acoust Soc Jap*, Vol 21, #3, May, pp. 137-140.
- D.S. Pallett, T.W. Bartel, and C.R. Voorhees (1976), "Recent Reverberation Room Qualification Studies at the National Bureau of Standards," *Noise Control Engineering*, Vol 7, #2, Sept-Oct, 1976, pp 71-80.
- A.P.G. Peterson (1975), "Device Noise and Background Noise from a Statistical Point of View," *Noise Control Engineering*, Vol 4, #2, March-April, 1975, pp 76-83.
- V.M.A. Peutz (1968), "The Sound Energy Density Distribution in a Room," *Reports 6th Intl Cong on Acoustics*, August, Paper E-5-2, pp E-165-168.
- J.T. Rainey, C.E. Ebbing, and R.A. Ryan (1976), "Modifications Required to Permit Qualification of a 269 Cubic Meter Reverberation Room," *Noise Control Engineering*, Vol 7, #2, Sept-Oct 1976, pp 81-86.
- R.M. Robinson (1961), "Arrangement of 24 Points on a Sphere," *Math Annalen*, Vol 144, pp 17-48.
- H.J. Sabine (1952), "The Use of Acoustical Materials in the Control of Industrial Noise," *Proc Third Annual National Noise Abatement Symposium*, Oct 10, 1952, pp 27-35.
- J. Tichy (1976), "Effects of Source Position, Wall Absorption, and Rotating Diffuser on the Qualification of Reverberation Rooms," *Noise Control Engineering*, Vol 7, #2, Sept-Oct 1976, pp 57-63.
- J. Tichy and P.K. Baade (1974), "Effect of rotating diffusers and sampling techniques on sound-pressure averaging in reverberation rooms," *J Acoust Soc Am*, Vol 56, #1, July 1974, pp 137-143.
- J. Tickner (1974), "Noise radiation by sources near to plane reflecting surfaces," *J Sound and Vib*, Vol 36, #1, 8 Sept 1974, pp 133-145.
- R.V. Waterhouse (1958), "Output of a Sound Source in a Reverberation Chamber and Other Reflecting Environments," *J Acoust Soc Am*, Vol 30, #1, Jan 1958, pp 4-13.
- R.V. Waterhouse and R.K. Cook (1965), "Interference Patterns in Reverberant Sound Fields II," *J Acoust Soc Am*, Vol 37, #3, March, pp 424-428.
- R. Waterhouse and D. Lubman (1970), "Discrete versus Continuous Space Averaging in a Reverberant Sound Field," *J Acoust Soc Am*, Vol 48, #1 (Part 1), July, pp 1-5.
- R.J. Wells and F.M. Wiener (1961), "On the Determination of the Acoustic Power of a Source of Sound in Semi-Reverberant Spaces," *Noise Control*, Vol 7, #1, January-February, pp 21-29.
- T. Yamamoto (1961), "On Distribution of Sound Energy Along a Corridor," *J Acoust Soc Jap*, Vol 17, #4, December, pp 286-292.
- R.W. Young (1959), "Sabine Reverberation Equation and Sound Power Calculations," *J Acoust Soc Am*, Vol 31, #7, July, pp 912-921.
- R.E. Wise, G.C. Maling, Jr., and K. Masuda (1976), "Qualification of a 230 Cubic Metre Reverberation Room," *Noise Control Engineering*, Vol 7, #2, Sept-Oct 1976, pp 98-104.

Chapter 14

Community Noise Measurements — L_{eq} , L_{dn} , L-levels

14.1 MEASUREMENT PROCEDURES

14.1.1 Sound Propagation Outdoors and Source Characteristics. In the selection of places and times for measuring community noise, it is helpful to recognize some of the factors, in addition to the noise sources, that affect the measured sound level. A brief review here will include the propagation from a point source and a line source, the effects of reflecting surfaces, barriers, terrain, atmospheric conditions and wind (Kurze and Beranek, 1971).

When measurements are made at a distance from discrete sources, they will usually be found to be nearly as they would be for simple sources. Such sources under ideal conditions show an attenuation (decrease) of sound level of 6 dB for each doubling of distance from the source. This ratio applies only along a radial path from the source and where there are no interfering objects. Most real sources are somewhat directional, however, and therefore the sound levels at equal distances from the source are not independent of the direction.

When many equal sources are in line, as occurs essentially in heavy traffic on a highway, the attenuation of sound level tends to be 3 dB per doubling of distance perpendicular to the source. This behavior is characteristic of a line source. The 3-dB rate continues until the distance from the source approaches the length of the source.

This attenuation described for ideal point sources and ideal line sources is often referred to as resulting from geometrical spreading or wave divergence and could be called normal attenuation.

These simple descriptions of the behavior of sound level are idealized. In actual practice other effects upset the behavior. For example, walls, buildings, signs, people, and machinery commonly change the resulting sound field, particularly near such objects. They may act as barriers to reduce the level or as reflecting surfaces to increase the level at some locations and decrease it at others. These effects depend on the nature of the sound and the detailed characteristics of the interfering objects. Because of these effects, one should pick measuring points that are not near interfering objects.

The nature of the surface over which sound travels also affects the decay of the sound with distance. A hard surface does not add much to the normal attenuation, but thick grass and heavy shrubbery do affect the attenuation. But this increase in attenuation is significant mainly for long distances, say, greater than 50 m (150 feet).

The terrain is also another factor. A noisy source in a hollow is not as serious as one in the open. Buried highways are correspondingly less of a problem than ones on the general level of the surrounding area.

There is some sound attenuation from air absorption. This attenuation is a function of temperature, humidity and frequency. It is of significance mainly at high frequencies and over considerable distances.

Wind and temperature gradients also affect propagation of sound. Near the ground, wind tends to increase with height. This gradient tends to cause a sound wave traveling with the wind to bend toward the ground. But a sound wave traveling opposite to the wind will be bent away from the ground and will be attenuated at ground level. In this direction, against the wind, a shadow zone can form where the sound is attenuated severely. This increased attenuation for sound against the wind is one of the reasons it is hard to hear upwind from a source. (Another reason is the masking effect of wind noise at the ears.)

The normal temperature gradient, where temperature decreases with increasing height, tends to cause sound waves to bend upward and adds to the attenuation of the wave. But this situation is changed when there is a temperature inversion at the ground (temperature increasing with height near the ground). This inversion often occurs on a clear night. Then the wave is bent downward, and the increased attenuation does not occur.

These effects can be significant in determining the noise level that actually occurs at an observation point. They are brought out here mainly to show that, at a considerable distance from a source, the noise level can change appreciably from time to time even with constant source level. One should correspondingly avoid unusual conditions when making measurements. Sometimes, however, it is helpful to measure under certain low velocity wind conditions, with the wind blowing in the direction of sound propagation from a noisy factory to a residential area. This condition could very well be the one that shows the most serious effects of the noise.

14.1.2 Choice of Microphone and Microphone Orientation. A non-directional microphone should be used for general community noise measurements. This requirement is usually best satisfied with a small sound-level-meter microphone. For most locations in a community, noise will be coming from many directions, and the type of microphone with a uniform random-incidence response is clearly best suited for this use. The type with a uniform perpendicular-incidence response should not ordinarily be used for measurements in the USA, because it does not satisfy the requirements in the USA sound-level-meter standard, but it can be useful for measuring a localized source.

The microphone should normally be pointed vertically (unless air traffic tends to go directly overhead), to avoid pointing at any particular source.

A weather-proof microphone system is also very desirable for most surveys, particularly if the metering system is left unattended. Such a system is shown in Figure 6-18.

14.1.3 Microphone Height. For outdoor noise measurements, the microphone is often placed 1.2 to 1.5 m (4 to 5 feet) above the ground (ISO/R 1996) and away from walls, buildings or other sound-reflecting surfaces (ISO/R 1996 recommends a distance of at least 3.5 m [11 ft]).

When a general survey of the noise in the entire community is attempted, the use of a microphone situated well above the surrounding buildings has been pro-

posed (Simmons and Chanaud, 1974). This arrangement is possible with a tethered balloon. More commonly, in community noise surveys the measurement microphone is mounted on a pole.

14.1.4 Microphone Position. When studying community noise, it is necessary to decide what is to be measured. If traffic noise is to be measured, then a location for the microphone about 50 feet away from the travel lane and away from buildings and other reflecting surfaces is a logical location. But if traffic noise is only one part of the community noise, the microphone should not be located in a position too close to a highway or it may give undue emphasis to traffic noise.

In a city, traffic noise can hardly be avoided but its contribution to the noise impact will vary significantly from one location to another. Thus, if a general survey is desired, measurements at a number of places are necessary.

If the enforcement of a noise ordinance regarding noise at the lot line of a factory is required, the proper measurement points are as close to the lot boundary line as feasible. The position of the survey points on that line would also be determined by the points near which disturbances are likely to occur. Thus, if residences are nearby, the points nearest the residences are logical selections. Further checks at the boundary points nearest the major noise sources of the factory are also necessary.

14.1.5 Wind Noise. Wind blowing on the microphone produces a noise due to air turbulence. (see paragraph 6.5) When the wind is strong, the resulting wind noise level is so high that one cannot make satisfactory noise measurements. Fortunately, the wind noise can be reduced significantly by the use of a windscreen, without noticeably affecting the measurement of noise from other sources (see Figure 6-13). For measurements outdoors, then, a windscreen should always be used. The windscreen also protects the microphone from dust and dirt.

Unless the noise to be measured is higher in level than 70 dB(A), noise measurement should not be attempted in winds above 20 mph (32 km/h), even with a windscreen. For general community noise measurements, avoid making measurements in winds above 12 mph (20 km/h).

When the wind is excessive during a measurement run, it is usually better to repeat the run under less windy conditions than to try to ignore the data that occurs during excessive wind. Ignoring some data often means that the remaining data do not really characterize the noise for the required period.

14.1.6 Observer. If noise is coming with reasonable uniformity from many directions to the point of measurement, the location of the observer is not critical. But, in general, the observer should not stand close to the microphone, in order to avoid interfering with the sound field near the microphone. The use of a tripod mount with a connecting cable between the microphone and the sound-level meter allows the observer to be several feet away from the microphone. It also allows easy manipulation of the controls and reading of the level, without disturbing the microphone.

If noise from a specific source, for example, an air conditioner, is to be measured, the observer should stand to keep his body out of the way of the noise

path; see Figure 14-1. The line joining the observer and the microphone should be essentially perpendicular to the line joining the noise source and the microphone. The observer should stand so that he is not in line with the microphone and source.

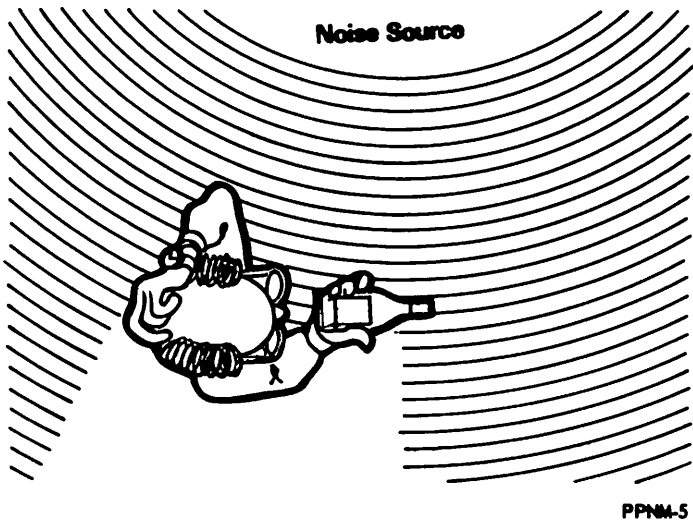

Figure 14-1. Proper way for observer to stand and hold a sound-level meter when a specific source is being measured and a microphone rated for random-incidence response is used.

14.1.7 Calibration and Calibration Checks. Accurate measurements are essential for noise monitoring. Although sound-measuring instruments are generally stable and reliable, calibration checks before and after a series of measurements provide added assurance that the instruments are operating properly and indicating the noise level within the specified accuracy (see paragraph 7.5).

The calibration check should be a complete test of the microphone to the indicator. This test is conveniently performed by either of the acoustical calibrators shown in Figures 7-4 and 7-5. These calibrators provide a known, stable, acoustical level at the microphone.

14.1.8 Dynamic Range. In many rural and suburban areas, the background A-weighted level is in the 30-to-45 dB range. When a powerful truck or noisy motorcycle passes nearby, the noise level can go beyond 90 dB(A). If a survey is being made near the take-off point of an airport, the maximum levels are much higher. These values illustrate the fact that one must be prepared to measure a wide range of levels. When an instrument is being operated unattended, it must be able to measure a wide range of levels without operator intervention. Such a range is often called "dynamic range," and a range of 90 dB is desirable.

14.1.9 Impulsive Sources. When a source is impulsive in character, and it is the main source, exceptional instrument characteristics are required for its measurement. They are met by an impulse-type meter, such as the 1982 or 1933 Precision Sound-Level Meter and Analyzer. It has a very high crest-factor capability as well as a detector that has a fast rise time and slow decay, as required by international standards for impulse measurements.

14.1.10 Reading the Level. Since noise level is hardly ever constant, the indication on an instrument is usually fluctuating. One must, therefore, decide how to read the indicating instrument. When the instrument is a community noise analyzer, the fluctuations are taken into account, and a set of specific values are provided. One must then decide only on the L-values to select. (see paragraphs 4.11 to 4.13)

If, however, a sound-level meter is used to measure vehicle noise on a passby test, for example, the maximum value indicated with A-weighting and fast meter response is the one selected. This choice is not a universal one. For something other than vehicle noise, the selected value is dependent on what is to be measured. For many other measurements, A-weighting and slow meter response are used. If many samples are taken, the indicating instrument should ordinarily be read at the value it shows at the selected sampling intervals.

If only one or two basic samples are to be read off the meter in a relatively short period, for example, to rate the noise of a device, one must decide what is the desired value. The choice can be expressed as L_{eq} , L_{50} , L_{10} , and L_{90} , (see paragraphs 4.11 and 4.13) or maximum and minimum levels. L_{eq} is an estimate of the true rms sound pressure, and L_{50} is one measure of the central tendency (see ANSI, S1.13). If the fluctuations are small, say less than ± 3 dB, the values for L_{eq} and L_{50} are essentially the same and are approximately the average reading.

For larger fluctuations it is better to take many samples and calculate the desired value. But a rough estimate can be obtained for the rms sound-pressure level for a fluctuating level that changes more than ± 3 dB by selecting a level that is about 3 dB below the average of the peak levels that are observed. Whenever such an estimate is made, it is essential to note the extent of the fluctuations as well as the estimated level.

For L_{10} , the estimated level is that of the peaks that occur occasionally. For L_{90} the estimated level is the lower levels that occur occasionally. The maximum and minimum levels are those observed during a given period, and they are usually more extreme than L_{10} and L_{90} .

14.1.11. Length of sampling period. It is important to recognize that it takes time to get meaningful results for a varying noise level. It is obvious that one must first of all cover the time during which the noise is varying. In addition, one must take an adequate number of samples to get a reasonable sound-level distribution characteristic.

At many places in a community, the levels vary significantly during the day, and the distribution of levels is often complicated. Measurements with a sound-level meter for only brief periods are often poor indications of the various exceedance levels that are representative of the conditions at the point of observation. In fact, measurements over as long as a 10-minute period may show errors of as much as 5 dB for L_{10} when compared to a full hour of sampling (Schultz, 1972), or even more when an unusually high level noise occurs for an appreciable time when the level is not being measured.

The 1945 Community Noise Analyzer samples very rapidly. In a half-hour run, it uses 8191 samples. That means the 1% exceedance level, L_1 , is based on the level for 82 samples, which is enough for meaningful results. The 0.1% exceedance level, $L_{0.1}$, is based on only 8 samples, which can give useful information but not of high reliability. Longer runs can give more reliable results because of the greater number of samples taken. For runs of 4 hours or more, 65,528 samples are counted.

If one attempts to sample for shorter periods, the upper exceedance levels will be based on very few samples and will be of doubtful value. Since it is the upper sound levels that are of more importance in determining the effect of a noise environment, the need for basing the analysis on an adequate number of samples is clear.

14.1.12. Sampling Techniques. Since the number of samples required to estimate the various exceedance levels is very large if reasonable accuracy is desired, a number of sampling procedures have been developed for manual sampling. The most successful of these appears to be sampling for a few seconds quite frequently, for example, 5 seconds every 2.5 minutes, or 1/2 second every 15 seconds. This procedure appears to give a better estimate of the levels for a one-hour period than if samples are taken for some 5-minute period during the hour (Kamperman, 1973; Schultz, 1972).

This procedure of sampling for short periods very frequently can be done manually with a sound-level meter. With the instrument set to A-weighting and slow meter response, the reading can be noted, say, every 15 seconds. In an hour, 240 readings can be collected. This procedure is tedious, but under some cir-

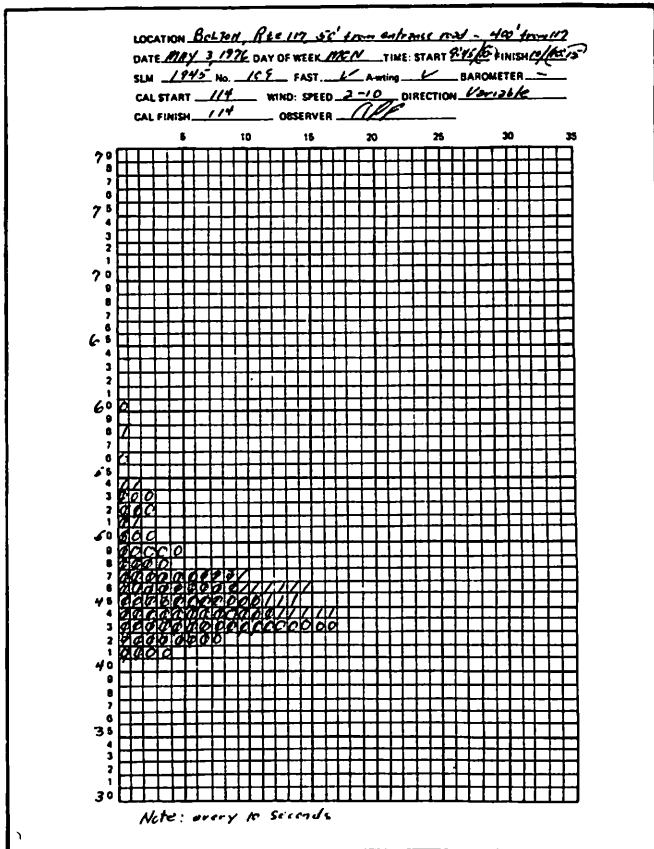

Figure 14-2. Data sheet for sampling community noise levels by hand with a sound-level meter. From the 180 levels recorded here, one can estimate L_{10} as 50 dB, L_{50} as 45 dB, and L_{90} as 42 dB.

cumstances it may be the one most readily available. Such a sample should give a good estimate for L_{eq} , for the period covered, but, if the level is fluctuating considerably, many more readings would be necessary for a good estimate of L_{10} (Yerges and Bollinger, 1973).

When sampling community noise with a simple sound-level meter, it is convenient to have prepared data sheets that permit easy recording of the number of occurrences at a given level, Figure 14-2, (see also, Watson et al., 1974). It is possible then to take readings every 10 seconds. (See also Yerges and Bollinger, 1973).

The data sheet of Figure 14-2 is arranged so that the decibel values are marked on the sheet to cover the expected range for the location. Thus, for example, in a relatively quiet area, the lowest level could be labeled 30 dB and the top level would then be 79 dB as shown in the figure. But if a location near a highway is being measured, a range from 40-to-89 dB would probably be better. Each observed level is recorded by a mark in a bin corresponding to the nearest whole number of dB. A slash can be used for one set of samples, a backward slash for a second, and a circle for a third, or the alternate marks can be used for overflows. About 200 samples can be recorded before overflow is likely to occur, but the actual number depends on the spread of the distribution. Any samples beyond the range of the chart would be recorded as the numerical value in the margins.

For estimates of L_{10} or L_1 , the untiring reliable and more rapid operation of automatic measuring equipment is a great boon. When measurements over a 24-hour period are required, as for L_{dn} , the automatic equipment is almost essential.

It is important to note that limited sampling tends to give an underestimate of the true level for L_{10} . In fact, for a 5-minute sampling out of an hour, the error can be 10 to 15 dB (Schultz, 1972). Since L_{10} is regarded as a good measure of the intruding noise levels, this underestimation is particularly serious. Furthermore, L_{90} tends to be overestimated with limited sampling. Since L_{90} is regarded as a good measure of the ambient or residual noise level, this tendency also reduces the measured estimate of the seriousness of intruding noise. Such considerations lead to serious doubts about the usefulness of studies done with limited sampling.

14.1.13 Record of Measurements. A sufficiently detailed record of the results of a noise measurement is an essential part of a measurement task. Noise measurement results are sometimes used in legal proceedings, which adds further importance to preparing adequate and proper records. In order to help in ensuring that the essential data are recorded, data sheets designed specifically for a noise problem should be prepared beforehand.

Some of the important items to be included are as follows:

Instrumentation

1. The instruments used, including name, make, type and serial numbers.
2. Date of latest laboratory calibration.
3. On-site calibration and battery checks before and after a series of measurements.
4. Instrument settings.
5. The readings taken.

Environmental

1. Time and date of measurements.
2. Name and location of measuring area (a sketch may be helpful).
3. Obstacles, walls, etc., that may influence readings.
4. Position of observers.
5. Position of microphone.
6. Names of observers.
7. General weather conditions — temperature, wind, barometric pressure.

14.2 COMMUNITY NOISE CHARACTERISTICS.

14.2.1. Characterization of Varying Noise Levels. In the study of data that vary with time, many ways of characterizing the data have been developed in the fields of statistics, physics and engineering. One of these ways is by means of the cumulative distribution function, and the use of such a function is implied when exceedance levels are used for community noise. As used in community noise analysis, this function gives the fraction of time that the A-weighted sound level is above a given value.*

A wide variety of theoretical distributions have been analyzed. For a number of reasons the distribution called “Gaussian” or “normal” is the one most widely used as a model. A plot of the density distribution of this function (the slope of the cumulative distribution) is the familiar bell-shaped curve for a Gaussian distribution.

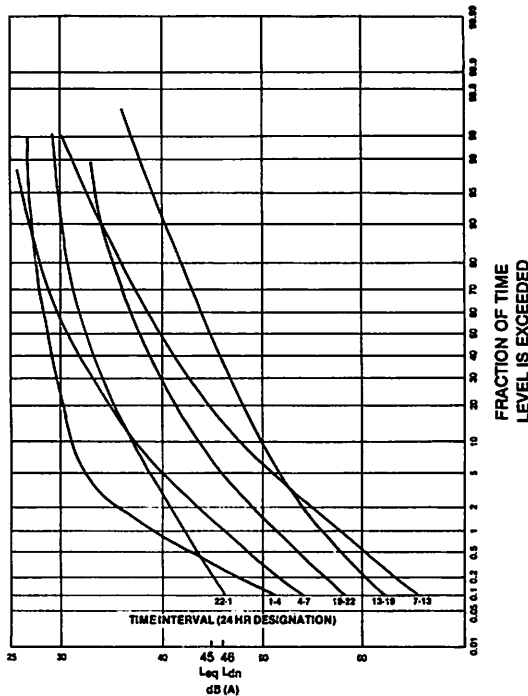

Figure 14-3. Cumulative Distribution of levels observed in a rural area in New England.

*In statistics, the cumulative distribution function usually shows the fraction of time that a variable is equal to or *below* a certain value.

Special probability graph paper is available to plot such distributions. This paper has the scale adjusted to yield a linear plot for a cumulative distribution when it is Gaussian. Such a distorted scale is widely used in papers on community noise, because it is conveniently arranged to show the full range of exceedance levels commonly used. It will be used here to show some distributions.

Some community-noise distributions are nearly Gaussian in character. But the actual distributions show a much more definite lower limit than is expected for a Gaussian distribution, see the examples in Figure 14-3. (see also Schwarz et al., 1974). The upper levels are also limited.

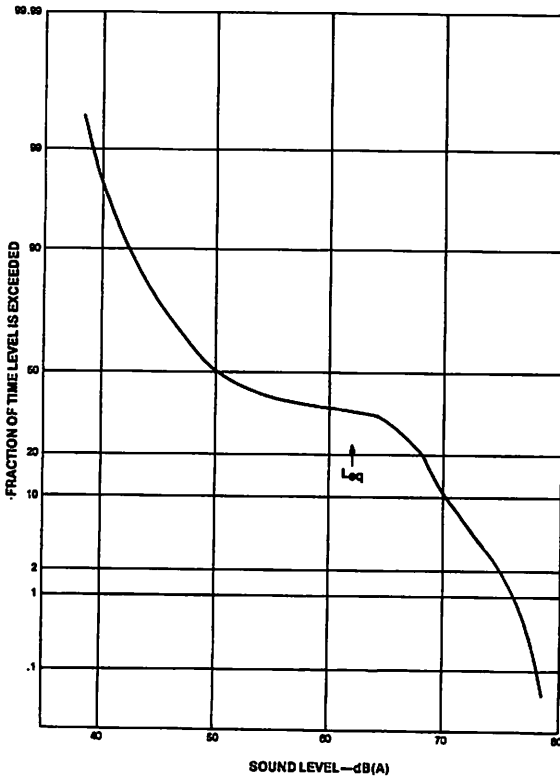

Figure 14-4. Cumulative distribution of levels over a 24-hour period in a suburb of Boston. A power lawn mower was used nearby for part of the time.

The effect of the lower limit is generally to produce what is sometimes called a “skewed” distribution, where high sound levels occur more frequently than would be expected from the behavior at lower sound levels. The examples shown in Figures 14-3 and 14-4 could be called “skewed.”

Occasional distributions show a strong bimodal character, that is, having two modes. These are usually a result of two distinct types of action that occur at widely different levels and at different times, or they may be the result of a noisy operation that intrudes for a short time in an otherwise relatively quiet location. The example shown in Figure 14-4 was measured in a suburban neighborhood with a power lawn mower that operated for only a fraction of the total observa-

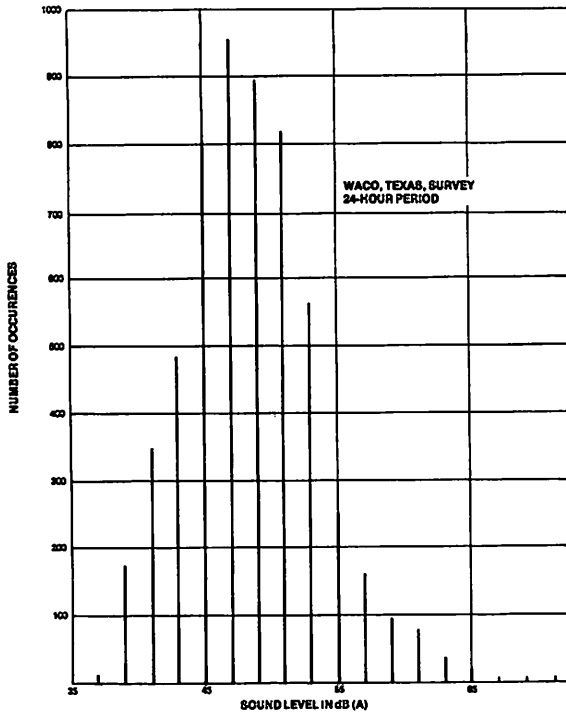

Figure 14-5. Density distribution of levels from a survey in Waco, Texas. (Watson et al., 1974)

tion period. When it was on, it produced a relatively high level that easily overrode the normal background noise. Thus, the noise was a superposition of two distinct distributions, and the bimodal character can be deduced from the distribution curve because the slope of the curve has two peaks. (A plot on linear paper is more suitable for observing slope changes.)

More modes are in reality always present, but, when there are a wide variety of them with none being particularly dominant, the modes blend in to form a reasonably smooth distribution.

The distribution can be given in another way by a graph that shows the number of times that a given level was observed. These values are plotted as a function of the level, and this plot is sometimes called the density distribution. Such a plot is shown in Figure 14-5 for data from a Waco, Texas, survey (Watson et al., 1974). These data, covering a 24-hour period, show a slightly skewed distribution of levels.

The density distribution for the power lawn mower example of Figure 14-4 was derived from the smoothed curve of the cumulative distribution, and it is shown in Figure 14-6. This type of plot shows more clearly the bimodal character of the noise. Such a plot can be useful in interpreting the noise history, but it does not show the exceedance levels that are helpful in rating the noise.

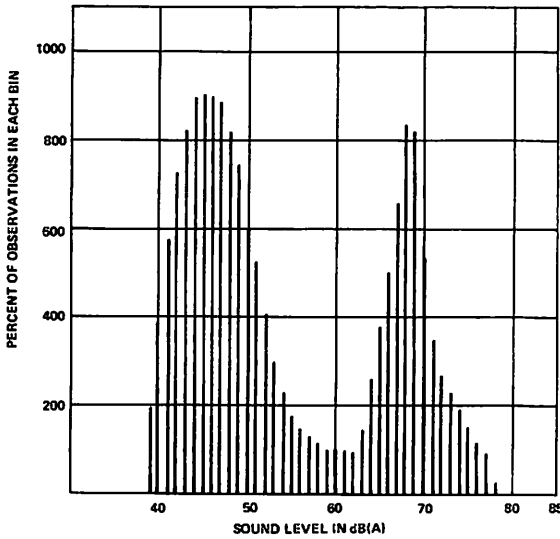

Figure 14-6. Density distribution of levels for neighborhood noise when a power lawn mower was operated nearby for a part of the time.

14.2.2. Calculating Equivalent Sound Level, L_{eq} , from a Set of A-Weighted Levels. The equivalent sound level is the level of the time-weighted, mean square, A-weighted sound pressure. The time interval over which the measurement is taken should always be specified (U.S. EPA, 1974, Glossary 1).

In combining sound levels to obtain L_{eq} , the sound levels must be converted to something essentially proportional to sound energy before being averaged. If the sampled levels are measured under similar conditions, the usual procedure is to assume any arbitrary reference pressure, convert the levels to pressure-squared values, average those values, and convert this average value back to a level referenced to the assumed arbitrary pressure value. If some of the measured values are representative of the levels for periods different from others, the corresponding time factors should be applied in the averaging of the pressure-squared values.

For sound levels sampled at equal intervals the basic formula is

$$L_{eq} = 10 \log \frac{1}{n} \sum_{i=1}^n 10^{L_i/10}$$

where L_i is one of the n sampled levels, or in extended form

$$L_{eq} = 10 \log \frac{1}{n} (10^{L_1/10} + 10^{L_2/10} + \dots + 10^{L_n/10})$$

For example, suppose the measured A-weighted levels at 10-second intervals are 52, 55, 53, 57, 65, and 53 dB. A direct application of the preceding formula yields:

$$L_{eq} = 10 \log \frac{1}{6} (10^{5.2} + 10^{5.5} + 10^{5.3} + 10^{5.7} + 10^{6.5} + 10^{5.3}) = 58.8 \text{ dB}$$

If the sound levels are obtained manually, the equivalent sound level can be calculated on scientific calculators.

When many sound levels have to be included in the average, it is easy to make a mistake somewhere in the process of punching all the buttons. In order to make it easier to correct for an error and to catch one, it is usually desirable to divide the total levels into a number of equal groups. The summed pressure squared value is obtained for each group and stored. When these values have all been calculated without any obvious errors, they are summed and the calculations are completed.

This problem of handling many levels without mistakes leads to the recommendation that a programmable calculator be used. Then fewer entries need to be made, which reduces the chances for error. Of course, the more reliable procedure is to use an instrument that has already been programmed to do the total job, such as the 1945 Community Noise Analyzer.

As a cross check on the calculations, arrange the sound levels in numerical order. Select L_{10} . * This level is often about 3 dB higher than L_{eq} . If the calculated L_{eq} differs from $L_{10} - 3$ by more than ± 2 dB, recalculate in a different order as a further check.

14.2.3 Combining L_{eq} Values. It is readily possible to combine L_{eq} values for successive runs to get an over-all L_{eq} . The durations of the runs do not have to be the same. The L_{eq} values are combined on an energy equivalent basis:

$$L_{eqTOTAL} = 10 \log \frac{T_1 \times 10^{L_1/10} + T_2 \times 10^{L_2/10}}{T_1 + T_2}$$

where L_1 and L_2 are the L_{eq} values for the periods T_1 and T_2 .

For example, suppose L_{eq} is 58 dB for 12 hours and 55 dB for 6 hours. the combined L_{eq} for 18 hours is then

$$L_{eq(18)} = 10 \log \frac{12 \times 10^{58/10} + 6 \times 10^{55/10}}{18} = 57.2 \text{ dB}$$

14.2.4. Calculating the Average Day-Night Sound Level from a Set of L_{eq} Values. The calculation of the average day-night sound level is essentially the same as the calculation of L_{eq} except that the levels at night (2200 to 0700 hours) are increased by 10 dB before they are averaged in.

One of the logical procedures in studying community noise exposure is to measure the hourly equivalent sound level for each hour of the day. These data permit one to see how the noise level does vary with time and one can, for example, see the relation between rush-hour traffic and busy commercial operations and the noise levels.

When these hourly equivalent sound levels are available, the day-night level can be calculated as follows:

$$L_{dn} = 10 \log \frac{1}{24} [10^{L_{h7}/10} + 10^{L_{h8}/10} + \dots + 10^{L_{h21}/10} + 10^{L_{h22}+10/10} + \dots + 10^{L_{h6}+10/10}]$$

where L_{h_n} is the hourly equivalent level from n to $n + 1$ hours.

The basic procedure is as shown for L_{eq} except that the hourly equivalent levels for the night are increased by 10 dB before being used in the calculation.

*When the levels are in numerical order, L_{10} is the level that has only 1/10 of the values above it.

14.2.5. Relations among L_{eq} , L_{10} , L_{50} , L_{90} , L_{NP} , s . If a noise history has a particular statistical distribution of levels, the relations among some of the rating levels can be calculated from the distribution. In particular, if the levels follow a Gaussian distribution some of the relations are as follows:

$$L_{50} = \frac{L_{10} + L_{90}}{2}$$

$$L_{eq} = L_{50} + .115s^2 = L_{50} + .017(L_{10} - L_{90})^2$$

$$L_{10} = L_{50} + 1.285s$$

$$L_{90} = L_{50} - 1.285s$$

$$L_{eq} = L_{10} - 1.285s + .115s^2$$

$$L_{NP} = L_{eq} + 2.56s = L_{eq} + (L_{10} - L_{90})$$

Since sampled community noise levels do not generally follow a Gaussian distribution, these relations should not be taken too seriously.

A study of the relations of L_{eq} and the exceedance levels for various environmental noise distributions shows a strong correlation between L_{eq} and the range of levels from L_{10} to L_{25} (Driscoll et al., 1974). The relation $L_{eq} = L_{10} - 3$ dB is particularly good for the range of noise distributions considered in the study. (See also Bishop et al., 1973.)

As a practical matter, that simple relation $L_{eq} = L_{10} - 3$ dB is probably better for most community noises than any of those listed for a Gaussian distribution.

For those conditions where the level does not vary much, a better estimate can be obtained from the simple formula

$$L_{eq} = \frac{2}{3}L_{10} + \frac{1}{3}L_{50}$$

When L_{10} and L_{50} are available, one can compute L_{eq} from both of the above formulas and the larger of the two estimates of L_{eq} should be chosen as the estimate.

To illustrate the extent of the errors involved, a variety of observed distributions were analyzed. When L_{10} and L_{50} , and L_{eq} were used on the assumption of a Gaussian distribution, the range of errors for estimated L_{eq} was -20 to 0 dB. When the formula $L_{eq} = L_{10} - 3$ dB was used, the range of errors was -16 to $+3$ dB. When it was used with $L_{eq} = \frac{2}{3}L_{10} + \frac{1}{3}L_{50}$, the range of errors was also -16 to $+3$ dB. Large errors are most likely to occur in quiet suburban or rural areas or in urban residential areas early in the morning (see samples in Appendix A of Eldred, 1971).

One of the important reasons for the errors of the simple estimates is that L_{eq} is strongly affected by the higher sound levels. When a loud noise occurs for a significant fraction but less than 10% of the time, the effect on L_{eq} can be large without affecting L_{10} . The extreme underestimates of L_{eq} occurred under such conditions. Such distributions may be strongly bimodal, and they require extensive sampling for good estimates of the equivalent level. The large errors in the estimate are less likely to occur for extended periods than for short periods of $\frac{1}{2}$ to 1 hour.

These large ranges of the errors illustrate that the estimates are not generally accurate enough for rating noise exposure. Thus, when noise distributions have been determined by manual sampling, L_{eq} should be calculated by the straightforward but laborious procedure of averaging on a pressure-squared basis.

This procedure can easily be programmed in a computer or in a programmable calculator, which reduces the laboriousness of the procedure. Then the remaining problem comes in making certain that the levels are entered correctly.

REFERENCES

- D.E. Bishop and M.E. Simpson (1973), "Correlations between Different Community Noise Measures," *Noise Control Engineering*, Vol 1, #2, Autumn 1973, pp 74-78.
- D.A. Driscoll, W.J. Webster, F.G. Haag, and J.W. Farinacci (1974), "Statistical Correlates of the Energy-Equivalent Sound Level," *J Acoust Soc Am*, Vol 56, #4, Oct 1974, pp 1297-1299.
- K.M. Eldred (1971), *Community Noise*, US Environmental Protection Agency, Report No. NTID300.3, (Dec 31, 1971), U.S. Gov't Printing Office, Washington, DC 20402.
- G.W. Kamperman (1973), "Ways to weigh noise outdoors," *Noise Control Engineering*, Vol 1, #1, Spring 1973, pp 40-45.
- U. Kurze and L.L. Beranek (1971), "Sound Propagation Outdoors," Chapter 7 in L.L. Beranek, ed., *Noise and Vibration Control*, New York, McGraw-Hill.
- T.J. Schultz (1972), "Some Sources of Error in Community Noise Measurement," *Sound and Vibration*, Vol 6, #2, Feb 1972, pp 18-27.
- J.M. Schwartz, W.A. Yost, and A.E.S. Green (1974), "Community Noise Effort in Gainesville, Florida," *Sound and Vibration*, Vol 8, #12, Dec 1974, pp 24-27.
- R.A. Simmons and R.C. Chanaud (1974), "The 'Soft Fuzz' Approach to Noise Ordinance Enforcement," *Sound and Vibration*, Sept 1974, pp 24-32.
- S.S. Stevens (1972), "Perceived Level of Noise by Mark VII and Decibels (E)," *J Acoust Soc Am*, Vol 51, #2, Part 2, Feb 1972, pp 575-601.
- US EPA (1974), *Information on Levels of Environmental Noise Requisite to Protect Public Health and Welfare with an Adequate Margin of Safety*, No. 550/9-74-004, U.S. Environmental Protection Agency, Washington, DC 20460. (This publication is known as the "Levels" document.)
- H. Watson, Jr., G.J. Putnicki, and C.S. Riddell (1974), "An Environmental Noise Assessment of the Waco, Texas, Metropolitan Area with a Low Cost Methodology," *Proc of the Technical Program, NOISEXPO*, Chicago, Ill., June 4-6, 1974, pp 56-65.
- J.F. Yerges and J. Bollinger (1973), "Manual Traffic Noise Sampling — Can It Be Done Accurately," *Sound and Vibration*, Vol 7, #12, Dec 1973, pp 23-30.
- ISO R1996-1971, Noise Assessment with Respect to Community Response.

Chapter 15

Vibration Measurement Techniques

15.1 INTRODUCTION.

The reason for measuring vibration usually determines both the quantity to be measured and the point or points at which the vibration pickup should be placed. Sometimes, however, the correct pickup location is not obvious and some exploration of the vibration pattern of the device being studied is necessary. Furthermore, the pickup must be correctly oriented, as this too sometimes requires exploration.

Fastening a pickup to a device is usually a simple task, if the device is much larger than the pickup and if the important vibration frequencies are below 1000 Hz. Otherwise, difficulties may arise because of the mechanical problem of fastening the pickup at the desired point, because the pickup seriously affects the motion to be measured, or because the method of attachment affects the performance of the pickup.

15.2 CHOICE AND USE OF PICKUP.

Range. A very wide range of vibration levels can be covered by the pickups available. The 1933 Vibration Integrator System covers from .002 to 100 m/s^2 . The frequency range for acceleration is from 10 to 10000 Hz. The frequency range for velocity is essentially the same, and the velocity range is from 6.3×10^{-5} to 0.32 m/s .

Orientation of Pickup. The piezoelectric accelerometers used in GenRad vibration-measuring instruments are most sensitive to vibrations in the direction perpendicular to the largest flat surface on the pickup. This direction is the one for which the rated sensitivity applies. The sensitivity in other directions varies approximately as the cosine of the angle with respect to this rated direction, with a minimum of about 5% (or less) of rated sensitivity, when vibrated in a direction perpendicular to the rated one.

For accurate results, the pickup must be properly oriented with respect to the direction of motion. In practice, this orientation is usually not critical, however, because sensitivity changes slowly with direction, there being a drop of only about 2% for a 10-degree change in orientation.

The direction of maximum vibration at a point is often obvious from the structure that is vibrating. That is, it is usually in the direction of least stiffness. But this rule is sometimes misleading, because of the many possible resonant modes of vibration, some of which are perpendicular to the obvious direction of least stiffness. Such a mode can be strongly excited if close to the frequency of a component of the driving force. Furthermore, the nature of the motion may favor one mode of vibration rather than another.

When it is important to be certain of the direction of motion, one can measure the motion along three mutually perpendicular axes. Often one can select these so that only one of these components of motion is significant, and that will determine the choice of direction. Otherwise, they must be combined vectorially to

yield a resultant total; then, one needs to know the relative phase of the components. To determine phase, sums and differences can be measured with two pickups, or another set of three measurements can be made along mutually perpendicular axes that are rotated from the first step. With two sets of measurements, one can sort out the possible combinations and calculate the direction of the total motion. Often it is simple to obtain the direction of the maximum motion by experiment.

Except for simple harmonic motions, this resultant direction is of significance only as a function of frequency. Then an analyzer is essential so that one can determine the motion for the individual components.

When one attempts to measure vibration in a direction that is not the direction of the total vibration at the point of measurement, the orientation is more critical, because the vibration in the other directions will provide some signal in the output. It is often impractical to measure a directional component that is less than 5% of the total vibration at a point.

The above procedure does not lead to a measurement of the rotational vibration about a point. This type of measurement can be made with a torsional vibration pickup or by the use of two pickups mounted equally distant from the center of rotation. Then the sum and difference of the outputs of the pickups can give information on the rotational vibration.

Hand-Held Pickup. When one must explore a vibration pattern or make a quick check of the vibration amplitude, one is tempted to hand hold the pickup against the device being measured. If the device is massive and is vibrating with a significant amplitude, this technique can be useful for frequencies below about 1000 Hz. There are enough serious limitations to this technique, however, so that it should not generally be expected to yield accurate or highly reproducible results (Gross, 1965).

When the pickup is held by hand, a test probe, a pointed metal rod, is sometimes fastened to the pickup to facilitate applying the probe to the desired point. The motion is transmitted along the rod to the pickup, and the motion in the direction of the rod actuates the pickup.

Because the test probe adds another element to the pickup, the response is different from that of the pickup alone. Typical relative frequency response characteristics are shown for two types of probe in Figures 15-1 and 15-2. More than one

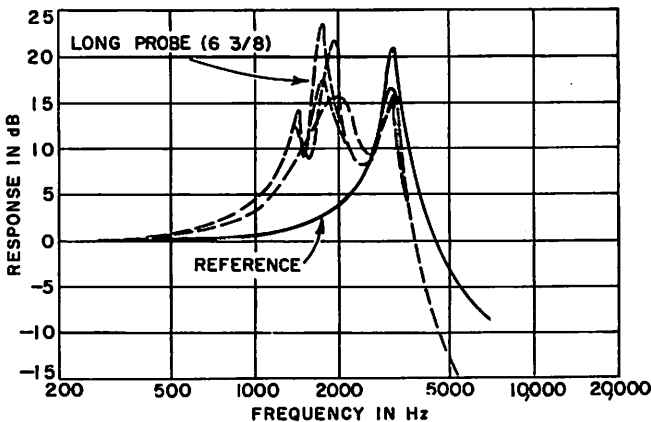

Figure 15-1. Frequency response of hand-held vibration pickup mounted on long (6 3/8-in.) probe. Several sample responses are shown. The curve labeled REFERENCE is the frequency response of the pickup without the probe.

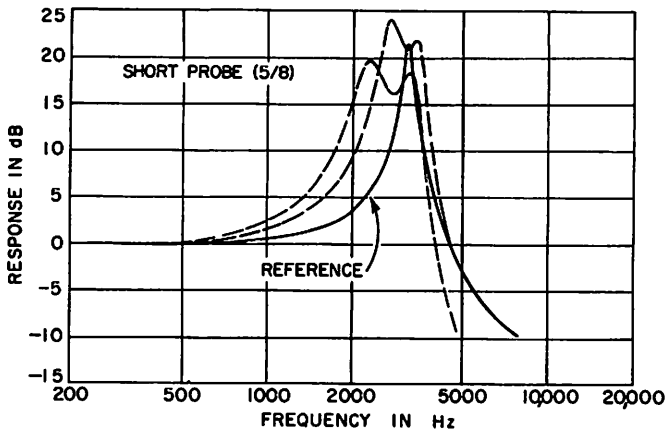

Figure 15-2. Frequency response of hand-held vibration pickup mounted on short (5/8-in.) probe. Several sample responses are shown.

response run is shown to indicate the variability that can occur. Note resonance in the range from 1400 to 2000 Hz introduced by the long (6 $\frac{1}{8}$ -in.) probe, and the one above 2000 Hz for the probe with the short conical tip.

Unless the device being tested is massive, the force, mass, resilience, and damping introduced by the hand may seriously alter the motion, and another method of applying the pickup should be tried.

Some vibration is applied to the pickup by tremor of the hand. This vibration is made up chiefly of components below 20 Hz, and the peak-to-peak order of magnitude is 5 in./s² acceleration, 0.2in./s velocity, and 10 mils displacement, when the pickup is held against a relatively stationary surface. These values will be appreciably attenuated by a low-frequency cutoff.

This tremor sets a lower limit to the vibration that can be observed when the pickup is hand-held against the vibrating device. One should not attempt to use a hand-held pickup down to the levels quoted above unless some filtering is introduced to reduce the low-frequency response.

Pickup Fastening Methods. Pickups are fastened to a vibrating surface by many different methods. For greatest accuracy the fastening should be as direct and as rigid as possible (Rasanen and Wigle, 1967; Gross, 1965). But if the acceleration is less than gravity, if only a temporary fastening is desired, and if only low frequencies are present, simple fastenings are adequate. These may be plasticene or double-sided adhesive tape placed between the base of the pickup and a flat surface at the point desired. If the surface is horizontal, flat, and smooth, the pickup may be wrung to the surface with a thin film of petroleum jelly. Another simple technique, useful on magnetic materials, is to fasten a magnet to the pickup and then attach the magnet to the surface to be measured.

At high accelerations, these simple fastenings are not satisfactory, and a stud or bolt must be used to hold the pickup directly against the surface being measured.

The performance of some pickups is affected by any attachment to the pickup body other than to the reference surface, so that a pickup should not be attached by clamps to the body of the pickup.

When the pickup is to be permanently installed, the use of an adhesive, such as a dental cement, Eastman 910, or an epoxy cement, is often advisable. For best

results, one should be careful to use only a thin layer, so that the elastic characteristics of the bonding cement will not affect the behavior of the pickup.

For maintenance tests, it is often convenient to fasten a very smooth flat iron disk to bearing housings with a very hard epoxy cement. The disk should be pressed as tight as possible against the housing. Then a magnetic attachment can be used, again with a thin film of silicone grease or petroleum jelly to ensure good contact.

The fastening should be rigid, so that the pickup does not move significantly with respect to the surface to which it is fastened. Any rocking motion, or looseness that might lead to chattering, should be prevented. If the fastening alone is not adequate to prevent this looseness, the use of some plasticene in addition may be helpful. When fastening, even by bolts, the use of a lubricant or petroleum jelly is advisable to ensure close contact between the pickup and the fastening surface, without putting undue strain on the pickup.

When the surface is not smooth or flat, the pickup is sometimes mounted on a bracket. For low vibration frequencies (below a few hundred hertz), the bracket can readily be made stiff enough so that it does not seriously affect the behavior of the pickup.

The procedure for obtaining a good connection between the pickup and the vibrating surface is illustrated by the specifications of MIL-STD-740B (SHIPS).

Transducers shall be attached as follows:

(a) Transducers shall be attached to blocks, which are to be brazed or welded to equipment, or subbase, as close as possible to the mounting points of the equipment to be tested.

(b) The blocks shall be made of steel and shall be as small as possible. The block surfaces on which transducers are mounted shall be plane and shall have a surface finish of 125 micro-inches rms or better and be mutually perpendicular within one degree.

(c) Three holes in the mounting blocks shall be drilled and tapped to a depth of at least ¼ inch with 10-32 NF threads to accommodate triaxial arrays of transducers which shall be attached to the blocks with insulated steel studs. The holes shall be perpendicular to the finished surfaces within plus or minus 1 degree.

(d) Just before transducers are mounted on a block, all mating surfaces shall be cleaned of all dirt, grease, and other foreign matter in preparation for mounting, the surfaces of the attachment area and the studs shall be lightly covered with clean oil or grease.

(e) The mounting blocks shall not be removed and shall be preserved with a rust inhibiting coating after completion of testing.

(f) If brazing or welding cannot be accomplished, the mounting blocks shall be attached to the location with a thin layer of epoxy resin cement. Blocks attached by cement shall be removed upon completion of test. The transducers may be attached directly to the equipment being tested only where there is insufficient space to accommodate the mounting block.

The pickup is calibrated in terms of the motion of the flat contacting surface of the pickup. Because of the resilience of the fastener and the mass of the pickup, this surface of the pickup will not move exactly as the surface being measured moves. At low frequencies this difference is easily made insignificant by the

relatively simple techniques discussed. But at high frequencies care must be used in fastening to keep this effect small.

If the mass of a pickup is small, weight less than 50 grams for example, simple temporary fastenings may be adequate even to frequencies beyond 2 or 3 kHz. This fact is illustrated by the response-vs-frequency characteristics shown in Figure 15-3 and 15-4. In each instance, the pickup was driven at a constant acceleration. The reference condition is the response for the vibration pickup wrung to the smooth, flat surface of the driver with petroleum jelly lubricant. The acceleration was .002 g.

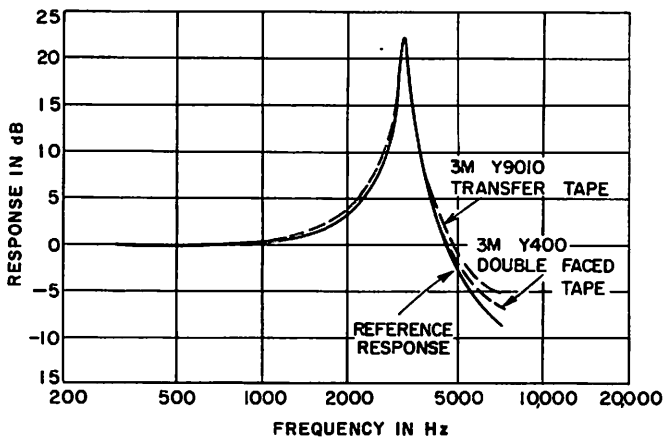

Figure 15-3. Frequency response of vibration pickup attached by means of Minnesota Mining Y9010 and Y400.

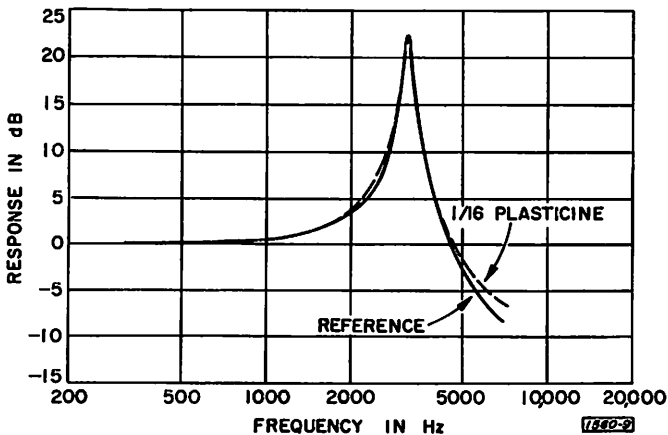

Figure 15-4. Frequency response of vibration pickup attached by means of 1/16-in. thick layer of plasticine.

The effect of fastening by means of double-sided tape was generally less than 10% deviation from the from the reference condition at all frequencies up to the resonance at 3200 Hz. In some instances, the deviation over the range to 3200 Hz was only about 2%. The variability was probably a result of changes in contact adhesion obtained with different samples of the tape.

Plasticene as a fastening means, even as thick as $\frac{1}{16}$ -in. showed very good reproduction of the reference performance, being within 2 to 5% up to 4000 Hz. In one instance, a marked departure from the reference performance was found even at 500 Hz, and this was quickly traced to the fact that the pickup had come loose from the plasticene. This example illustrates the importance of careful inspection of the fastening during a test, particularly when one cannot check the performance independently.

The response of the pickup when held to a smooth, flat, steel plate by means of the permanent magnet clamp is shown in Figure 15-5. Up to 5 kHz, the response is very similar to the reference response. One should fasten the pickup carefully to the magnet so that no rocking motion is possible, and the magnet itself should be placed on a smooth surface so that it, too, will not rock; otherwise, serious errors may result.

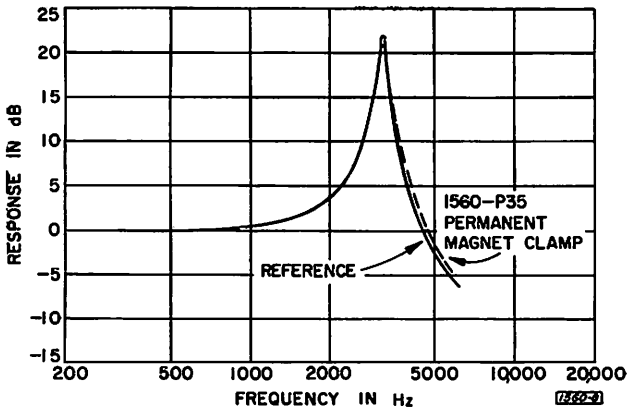

Figure 15-5. Frequency response of vibration pickup attached by a permanent-magnet clamp.

15.3 STRAY EFFECTS.

Effect of the Pickup on the Vibration. The mass added by the pickup to the vibrating surface being measured changes the motion of that surface. If the added mass is much smaller than that of the vibrating surface and is closely coupled to it, the effect is small except near resonant modes. Thus, it is important to have a lightweight pickup.

One can often judge the effect of adding the mass of a pickup by noting the difference in behavior with the pickup fastened and with another mass equal to that of the pickup, in addition to the pickup. If the difference is negligible for these two conditions, the effect of the pickup is usually unimportant. Under certain conditions near the resonant vibration frequency of the device under test, even a small mass can shift the resonance enough to affect the motion at the original resonant frequency by a large amount.

When it is possible to change the excitation rate or frequency so that resonance with the pickup in place is re-established, the behavior at the new resonant point will often be sufficiently similar to the resonance behavior without the pickup that the resonant condition can be satisfactorily measured.

When stroboscopic observation of the motion is possible, the effect of the mass of a pickup on the motion can often be judged by direct observation of the behavior with and without the pickup present.

Mounting of the Device Under Test. The actual vibration that a device experiences will depend on the way in which it is mounted. If it is rigidly mounted to a massive concrete structure, the vibration may be much less than if it is mounted with a very resilient mount. For many tests the very resilient mounting is preferred in order to obtain the maximum motion. But often the proper procedure is to mount the device for a vibration test just as it will be mounted in actual use.

Background Vibration. Some background vibration is always present. If a motor is put on a factory floor for a vibration test, it will be possible to measure motor vibration even when it isn't running. This background vibration must be considered as a lower limit to the vibration that can be measured. But, of course, one can do something about this lower limit. Often placing the device on a thick felt or foam pad will isolate it sufficiently from the background, but then the mounting is no longer rigid. Another approach is to use a separate, massive concrete block as a table on which to mount the device in any way desired. The block is suspended by resilient mounts. The natural vibration frequency of the block on its mounts should be made significantly lower than any frequency of interest in the test.

Peak Versus rms. Although a few applications of vibration measurements require the use of the peak or peak-to-peak amplitude, most experimenters specify these values only because they are traditional. When vibration signals are analyzed to find the individual components, however, the rms values are more useful. This usefulness depends on two facts. First, rms component values can be summed on an energy basis to give the over-all rms value. But the result of combinations of peak values of components can be misleading and confusing, particularly for coherent periodic signals, which are relatively common in vibration work. The second fact is that if the signal is random in amplitude distribution, there is an additional inconsistency among peak values. As a result, if you measure a peak value of a vibration signal, it is also wise to note the rms value.

15.4 CALIBRATION OF VIBRATION MEASUREMENT SYSTEMS.

In order to ensure that one can make satisfactory vibration measurements, the instruments used must be kept in proper operating condition.

The vibration calibrator should be used regularly to check the complete measurement system. If the acceleration produced by the calibrator reads between 340 and 430 rms in./s² (8.8 to 10.8 m/s²) there is reasonable assurance that the pickup and the meter are operating correctly. If the agreement is not satisfactory, one should first check that the correct pickup is being used, and that the calibrator is set correctly. If this checks and agreement is still unsatisfactory, another pickup should be tried. The next step would be to have the pickup and the calibrator checked at GenRad.

Vibration pickups are rugged and stable, but they can be damaged. Although a damaged pickup will ordinarily be detected by the check at 100 Hz provided by

the vibration calibrator, it is possible, but most unusual, for the sensitivity at other frequencies far from 100 Hz to be affected when that at 100 Hz is not. Therefore, the frequency response of pickups should be verified periodically by calibration at the National Bureau of Standards or at GenRad.

REFERENCES

Standards

ANSI S2.2-1959(R1976) Calibration of Shock and Vibration Pickups

ANSI S2.4-1976 Specifying the Characteristics of Auxiliary Analog Equipment for Shock and Vibration Measurements

ANSI S2.5-1962(R1976) Specifying the Performance of Vibrating Machines

ANSI S2.10-1971(R1976) Analysis and Presentation of Shock and Vibration Data

Other

E.E. Gross, Jr. (1965), "Vibration Measurements," *General Radio Experimenter*, Vol 39, #7, July, pp 3-9.

C.M. Harris and C.E. Crede (1975), *Shock and Vibration Handbook*, 2nd edition, McGraw-Hill, New York.

G.K. Rasanen and B.W. Wigle (1967), "Accelerometer Mounting and Data Integrity," *Sound and Vibration*, Vol 1, #11, November, pp 8-15.

Chapter 16

Noise and Vibration Control

16.1 INTRODUCTION

When we want to reduce noise or vibration, we usually begin by measuring the spectrum of the noise or vibration to obtain the quantitative information that is helpful in doing something about the problem. We compare the measured levels with the acceptable levels, which are often estimated by use of one of the criteria given in Chapter 4. The difference between these two levels is then the reduction necessary.

The next step is to find out how this reduction can be achieved most satisfactorily. A detailed discussion of this problem is beyond the scope of this handbook. But since many of those using this book are just beginning to work on noise and vibration problems, some introductory comments will be made. More detailed discussion can be found in the references at the end of this chapter. Of those, the NIOSH *Industrial Noise Control Manual*, the AIHA *Industrial Noise Manual*, and the American Foundrymen's Society *Control of Noise* are particularly recommended for their practical approach. Many other helpful books on noise and vibration control are listed in the references at the end of this chapter.

The journals *Sound and Vibration (S)V* and *Noise Control Engineering* are important sources of practical information on noise control, and S)V has regularly updated buyer's guides in this field. When materials are needed, it is helpful to consult the extensive "Compendium of Materials for Noise Control" prepared for NIOSH. Many trade journals publish occasional articles on noise control that are directed to situations peculiar to a particular industry.

The general approach to noise reduction can be divided into two major parts as follows:

1. Reduction of noise at its source
2. Reduction of noise level at the ear of a listener by changes in the path from the source.

Working on the source to reduce noise is usually considered to be the best approach. But in an actual plant situation it is often essentially impractical to modify production machines, and only the control of the path is possible. Ideally the machines should have been quiet in the first place, and in the future, noise ratings should be included among the specifications when buying new machinery.

Because of the increasing interest in noise control some vendors have prepared retrofit packages to quiet machines now in use. Even if a manufacturer does not have such a package available, he may be able to help reduce the noise from machinery he has manufactured.

Before embarking on a costly noise control program, it is sensible to see if relatively simple solutions can take care of the problem. Good general maintenance of machinery, for example, is important in keeping noise levels from climbing as machinery ages. Loose or broken parts can be a source of noise that is easily eliminated. Another example of a simple solution is the use of automatic door closers to maintain isolation between factory space and offices. Arranging to keep noisy machinery far away from areas that must be quiet is sometimes an easy solution.

REDUCE NOISE AT SOURCE

As a first step in reducing noise at the source, it is desirable to consider the basic purpose of the process that is noisy. Can some of the noisy steps in the process be eliminated? Can a quieter process be substituted? To help in reviewing this possibility, Table 16-1 lists processes and operations in pairs that often can produce equivalent results but that differ in the noise produced.

Table 16-1

Quieter vs noisier processes and operations

- Bolting vs riveting
- Welding vs riveting
- Compression vs pneumatic riveting
- Squeezing vs hammering
- Pressing or rolling vs forging
- Hot working vs cold working of metals
- Grinding or arc or flame gouging vs chipping
- Electrical vs pneumatic operation
- Mechanical vs air blast stripping or air jet ejection
- Low speed vs high speed processing
- Plastic vs metal fabrication
- Plastic gear vs metal gear drives
- Belt vs gear drives
- Wide spacing vs close spacing between noisy machines

In order to control noise efficiently it is essential to identify the major sources of noise, both with respect to the particular machines and also the parts of such machines. This task may be an easy one. For example, the stock tube for an automatic screw machine is often radiating a major part of the objectionable noise from such a machine, and it is obvious just from listening to the noise. On the other hand, in a factory space where many different noisy machines are operating, careful measurements and analysis of the noise and vibration at many points may be required before the relative importance of the many possible noise sources can be estimated. When machines can be operated separately it is often possible to rate each machine for its contribution to the overall level.

To rate the various mechanisms or parts of a machine for their contributions to the overall noise, consider the following techniques, some of which may be easy to apply to the problem at hand.

1. Change operating conditions and note changes in level
2. Disengage sections and note changes in level
3. Quiet separate sections or replace sections by quieter or different types of units and note changes in level.
4. Separate units by distance or enclosures and measure levels near various units.
5. Run separate sections individually and measure level of each.

Once the major noise sources have been determined, the nature of the noise should be identified. This identification may have been apparent from the study of the major sources. Or, if the major sources include many noise-generating elements, further analysis of noise and vibration may be required. For example, an induction motor produces magnetically generated noise, air-flow noise, bearing noise, unbalance noise and various other possible rotor vibrations. These noises can generally be distinguished by analysis of the noise (see section 16.7).

When the nature of the noise production is known, various noise and vibration control techniques can be tried on the major sources of noise. Many such techniques have been described in books and journals, and they range from replacing gears with some of better quality to a complete redesign of the machine.

A listing of approaches for reducing noise at the source is given in Table 16-2. In addition to using quieter processes, the main categories are to reduce energy available for producing the noise, to reduce the coupling that results in radiating the sound, and to reduce the radiating efficiency.

Table 16-2

Reduction of noise at source

- Substitute inherently quieter process
- Reduce energy available for producing noise
 - Balance and align
 - Use precision components, gears, bearings
 - Replace worn or damaged parts
 - Lubricate
 - Reduce speed
 - Reduce velocity of flow (air, gas, liquid)
 - avoid leaks
 - smooth flow — reduce turbulence
 - use mufflers or silencers, lined ducts
 - Add damping to absorb energy
 - Use resilient materials to reduce impact
 - Spread energy over time to reduce peaks
- Change coupling
 - Isolate sections with soft mounts
 - Fasten external parts at vibration nodes (minima)
 - Reduce radiating area
 - Detune — avoid resonant buildup
 - Clamp and change stiffness
 - Reduce mass of moving elements or increase mass of stationary elements

Of these various possibilities for reducing noise, some require redesigning the machine, which is usually impractical for the user. But some can be applied without much trouble. For example, lubrication is sometimes helpful, mufflers of various types are commercially available for installation on pneumatic devices, and damping materials can be applied to vibrating panels or lagging can be used on pipes or tubes. Sometimes air pressure and velocity can be reduced on pneumatic devices without reducing their effectiveness, and the noise of air flow decreases rapidly with a decrease in velocity.

PATH FROM SOURCE TO EAR

The path from a source to an ear of a person can be modified in many ways to reduce the level of noise exposure. The listing of Table 16-3 outlines a number of these possibilities. Of these the one that is often regarded as the easiest is to supply ear plugs or muffs for use by workers in a noisy environment. If good units are used, if the workers are properly educated in their use, and if they are sufficiently motivated to use the plugs regularly, the plugs can be effective. They are an important interim measure until other techniques have reduced the direct exposure to safe values.

Table 16-3

Reduction of noise by changes in path

Change position of source or listeners or both

Isolate device with vibration mounts

Isolate by barriers

by partial enclosures
(for source or operator)

by complete enclosures
(for source or operator)

} Absorptive treatment
facing source and
in ventilating ducts

Use ear protectors — plugs or muffs

Use absorptive treatment

(not helpful for those within a few feet of source)

16.3.1 Position. Keeping all persons away from the immediate vicinity of a noisy device is helpful in reducing noise exposure, but it is not often possible. Often some rearrangement of personnel can reduce exposure for most of them. In order for distance to be helpful in this respect it is essential that considerable acoustic absorption be present in the space, particularly near the source. Acoustical treatment is not effective for workers within 1 meter (3 feet) or so of the source. It can help significantly when the source is far away and the treatment can be installed between the source and those who are affected by the noise, particularly if the treatment covers the ceiling of a long, low room.

Some sources are highly directional. For example, a simple, unobstructed air jet has maxima at angles up to 45° off the axis of the jet with a minimum directly opposite to the jet stream. When it is possible to direct the jet away from all personnel, that should be done. But hard objects in front of the jet may reflect the noise and upset the normal directional pattern. Then some experimenting may be necessary to find the best arrangement for the jet.

Machines transfer some energy into vibration of the floor that supports them. Sometimes this energy is enough to cause serious noise problems. This transfer can often be reduced significantly by the use of vibration isolators, but care needs to be taken in the selection and installation of such mounts or the problem may become worse rather than better. Suppliers of these isolators furnish helpful information for selecting and applying these mounts.

16.3.2 Attenuating Structures. A number of different types of attenuating structures are used for reducing the noise level for the listener, for example, walls, barriers, and total enclosures. Almost any degree of reduction of airborne sound can be achieved by a total enclosure or a combination of several enclosures. But as the required attenuation increases so does the complexity, weight, and cost. In addition, great care must be taken that the attenuation gained by the enclosure is not lost by sound transmission through a ventilating duct or by solid-borne vibration. Because of this possible flanking transmission in ventilating systems, total enclosures frequently require carefully designed ventilating systems with ducts lined with absorbing material. These lined ducts are essentially mufflers for the air stream.

When a door is required in a total enclosure, it should be built with air-tight seals at all joints. A refrigerator-type door is usually satisfactory when it can be

used. A total enclosure should also be lined at least on part of the inside walls with absorbing material. This lining helps to keep the noise at the walls of the enclosure at the lowest practical level.

A barrier is not as effective as a total enclosure, but it does help to shield high-frequency sound. Little attenuation of low-frequency sound is obtained unless the barriers are very large, and the attenuation of high-frequency sound is usually only a few decibels unless the opening that remains is relatively small. Here, too, absorbing material should cover the barrier to avoid exaggerating the level by reflections from the barrier.

16.3.3 Illustrative Example. In order to illustrate the possible noise reduction achieved by use of vibration isolation, barriers, enclosures, and acoustic treatment, an example made up for the purpose is shown in a series of figures, Figures 16-1 and 16-2. We intend to show here only the general nature of the noise reduction obtainable as given by changes in the octave-band spectrum and the speech-interference level. Actual results will vary in detail, and situations do occur where the results differ materially from those shown because of factors not considered here. But, in general, the noise reduction shown in the figures can be considered typical.

Figure 16-1a shows the octave-band analysis of the noise from the assumed machine. The speech-interference level is also shown. This machine is a noisy one with a spectrum that shows appreciable noise energy all over the audible range. All the noise measurements are assumed to be made in the relative position shown for the microphone, designated M on the figures.

The use of vibration isolation mounts may be an important step in noise control. As shown in Figure 16-1b, the initial result, however, is often only a moderate reduction of the low-frequency noise. The machine itself usually radiates most of the high-frequency noise directly to the air, and the amount radiated by the floor is small. A reduction in the vibration level at the floor only is then not important at high frequencies. At low frequencies, however, the machine may be too small to be effective in radiating sound, and then the floor may act as a sounding board to contribute materially to low-frequency sound radiation.

It is even possible to increase the noise as a result of the use of vibration mounts. This result is usually found when the stiffness of the mounting is of such a value that some vibration mode is exaggerated by resonance, but resonance can be avoided by proper design of the mounting. In the illustrative example it is assumed that the mounting is sufficiently soft that the basic vibration resonance of the machine on the mounting system is below 20 Hz. In this particular example no significant change in the speech-interference level is shown as a result of the use of vibration isolation mounts alone.

The results shown in Figure 16-1c illustrate that a barrier is mainly effective at high frequencies, and there it produces only a moderate reduction in noise level. Even though the reduction is small, barriers are widely used for reducing noise. Many noise problems can be solved by minor reductions in level or by a series of minor reductions, and barriers are often readily used where more complete enclosures are impractical.

The novice in this field sometimes assumes that the materials used for sound absorption can also be used alone for sound isolation. If we build an enclosure solely of these materials mounted on a light framework, we would typically find the result shown in Figure 16-1d. Only at high frequencies do we have a noticeable reduction in level, and even there it is a small reduction.

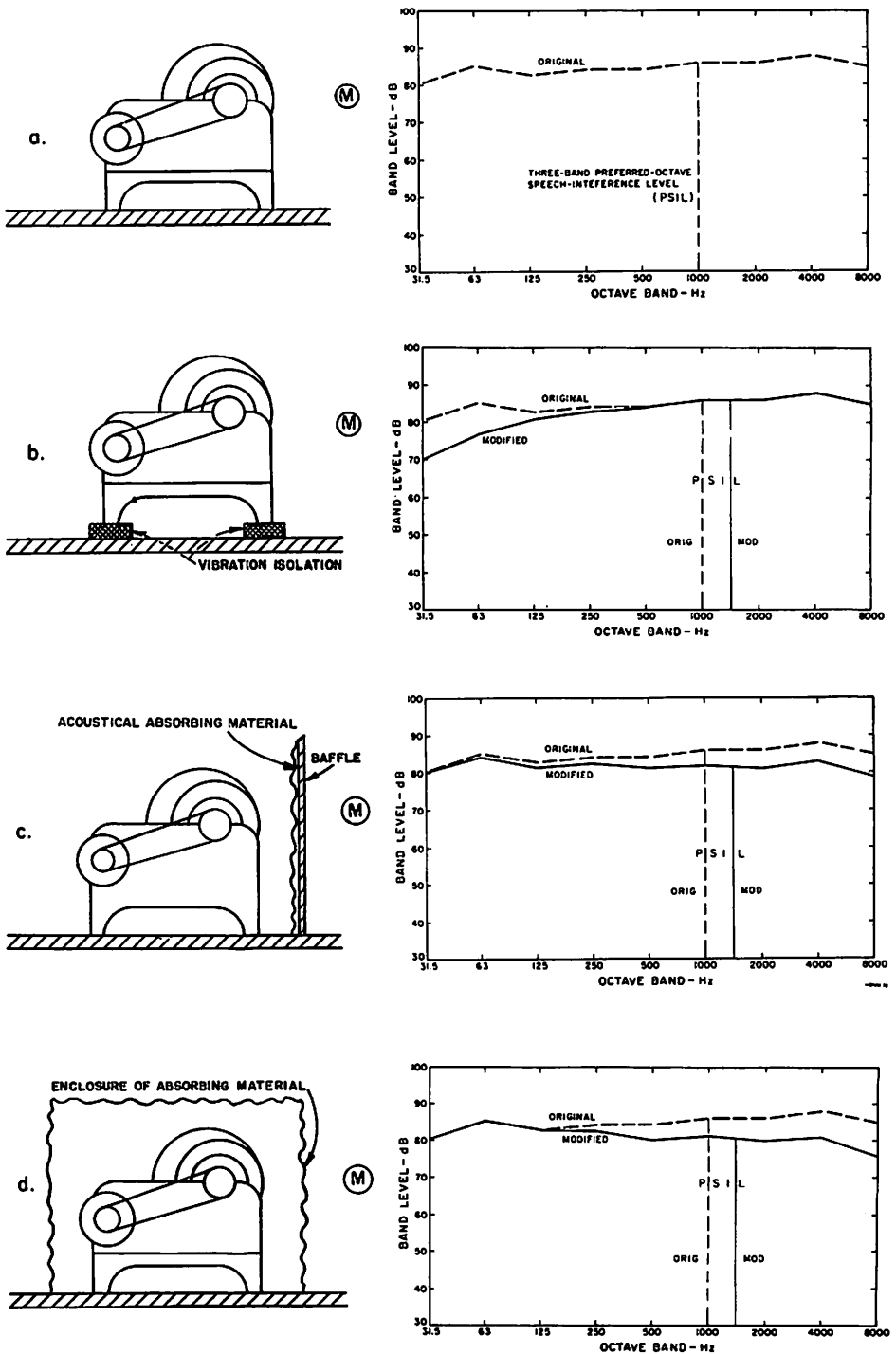

Figure 16-1. Examples to illustrate the possible noise reduction effects of some noise control measures; (M) is microphone position.

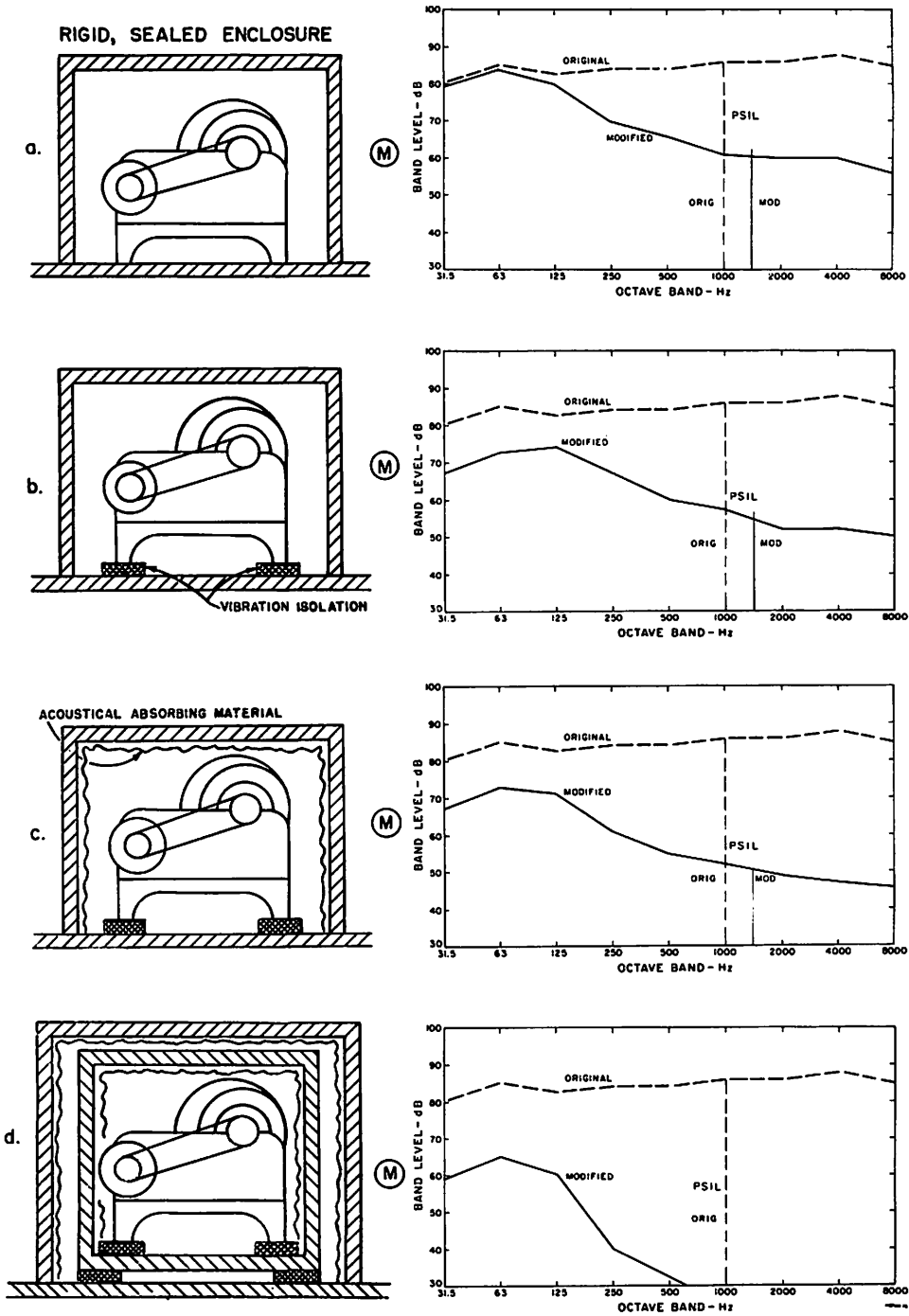

Figure 16-2. Examples to illustrate the noise reduction possible by the use of enclosures.

A more satisfactory enclosure is built of more massive and rigid constructional materials. Assume that we enclose the machine by a well-sealed, heavy, plaster-board structure. Then we might observe the result shown in Figure 16-2a. Here an appreciable reduction is obtained over the middle- and high-frequency range. The enclosure is not as effective as it might be, however, because two important factors limit the reduction obtained. First, the vibration of the machine is carried by the supports to the floor and then to the whole enclosure. This vibration then may result in appreciable noise radiation. Second, the side walls of the enclosure absorb only a small percentage of the sound energy.

The addition of a suitable vibration isolation mounting will reduce the noise transmitted by solid-borne vibration. This effect is illustrated in Figure 16-2b. Here we see a noticeable improvement over most of the audio spectrum.

When the sound absorption within an enclosure is small, the noise energy from the machine produces a high level within the enclosure. Then the attenuation of the enclosure operates from this initial high level. The level within the enclosure can usually be reduced by the addition of some sound-absorbing material within the enclosure, with the result that the level outside the enclosure is also reduced. This effect is shown in Figure 16-2c, which should be compared with Figure 16-2b.

If even more noise reduction is required than that obtained by the one enclosure, a second, lined, well-sealed enclosure can be built around the first. The first enclosure is supported within the second on soft vibration mounts. Then a noise reduction of the magnitude shown in Figure 16-2d can be obtained.

16.4 SUMMARY OF NOISE REDUCTION PROCEDURES.

The approach to a noise reduction problem can be summed up as follows:

1. Consider the source.

- Can a quieter machine be substituted?
- Can the noise energy be reduced?
- Can a useful change be made in the directivity pattern?
- Are resilient mounts of any use here?
- Can a muffler be used?

2. Consider the path from the source to the listener.

- Can the source or the listener be readily moved?
- Is acoustic treatment a useful solution?
- Should barriers be erected?
- Is a total enclosure required?
- Should ear protective devices be used?

16.5 FLOW CHART FOR SUMMARIZING PRODUCT NOISE REDUCTION PROCEDURES.

A flow chart that shows a systematic attack on reduction of product noise is shown on the following pages.

Step 1. Make a noise survey around the machine. This measurement, which assesses the extent of the problem, may be a survey with a sound-level meter set for A weighting, or an octave-band or one-third-octave-band analysis may be desirable. A number of measurements at various points around the machine are usually necessary.

Step 2. Compare the results of the measurements with the particular specification that must be satisfied.

Simplified Flow-Chart for Product-Noise Reduction Problems

STEP 1

MEASURE NOISE AROUND PRODUCT

STEP 2

ARE NOISE LEVELS ACCEPTABLE ?

YES

NO

PREPARE FINAL REPORT

STEP 3

CAN RESULT BE ACHIEVED BY DIFFERENT MEANS ?

YES

NO

IS NEW MODE APT TO BE QUIETER ?

YES

NO

IS IT PRACTICAL & ECONOMICAL ?

YES

NO

TRY IT

ARE MAJOR NOISE SOURCES OBVIOUS ?

YES

NO

ANALYZE NOISE NEAR & VIBRATION ON MAJOR SURFACES

ARE MAJOR SOURCES OBVIOUS ?

NO

STEP 4

CAN ANY ASSEMBLIES RUN SEPARATELY ?

YES

NO

MEASURE NOISE OF ASSEMBLIES

ARE MAJOR SOURCES OBVIOUS ?

YES

NO

CAN ASSEMBLIES BE SEPARATED IN SPACE ?

YES

NO

SEPARATE & MEASURE

ARE MAJOR SOURCES OBVIOUS ?

YES

NO

CAN ENCLOSURES BE USED AROUND ASSEMBLIES ?

YES

NO

MEASURE MODIFIED NOISE

ARE MAJOR SOURCES OBVIOUS ?

YES

NO

CAN QUIETER ASSEMBLIES BE USED ?

YES

NO

MEASURE MODIFIED NOISE

ARE MAJOR SOURCES OBVIOUS ?

YES

NO

CAN OPERATING CONDITIONS BE CHANGED ?

YES

NO

MEASURE UNDER NEW CONDITIONS

ARE MAJOR SOURCES OBVIOUS ?

YES

NO

IDENTIFY MAJOR SOURCES

IS NATURE OF NOISE OBVIOUS ?

NO

YES

ANALYZE NOISE

ANALYZE VIBRATION AT CRITICAL POINTS

IDENTIFY NATURE OF NOISE

STEP 5

VIBRATING PANEL OR FRAME ?

NO

YES

ANALYZE VIBRATION FIND SOURCE OF FORCE

SHOULD FORCE BE REDUCED FIRST ?

NO

YES

USE TRANSFER FUNCTION TO LOCATE RESONANCES, PLOT MODE SHAPES

STEP 6

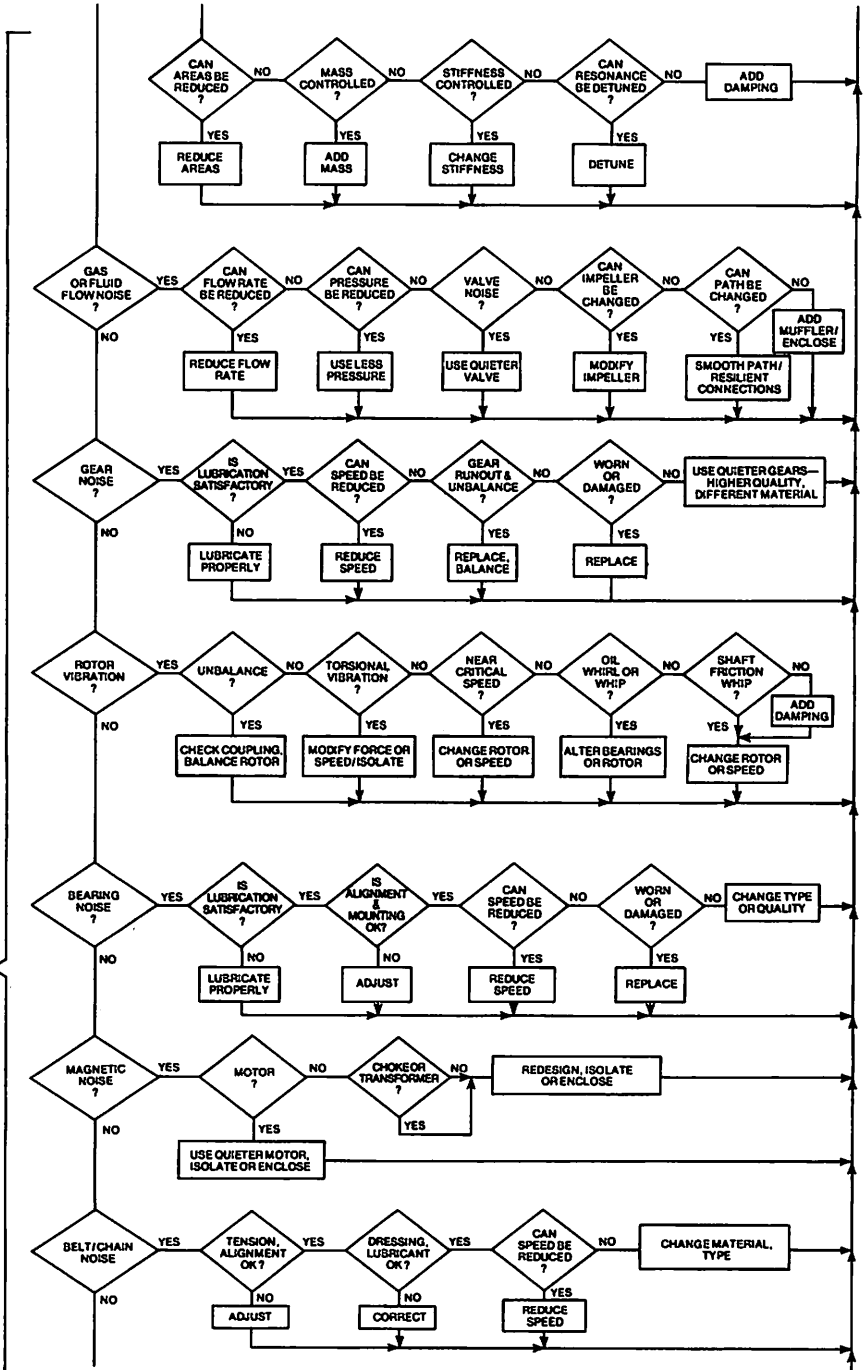

STEP 6 continued

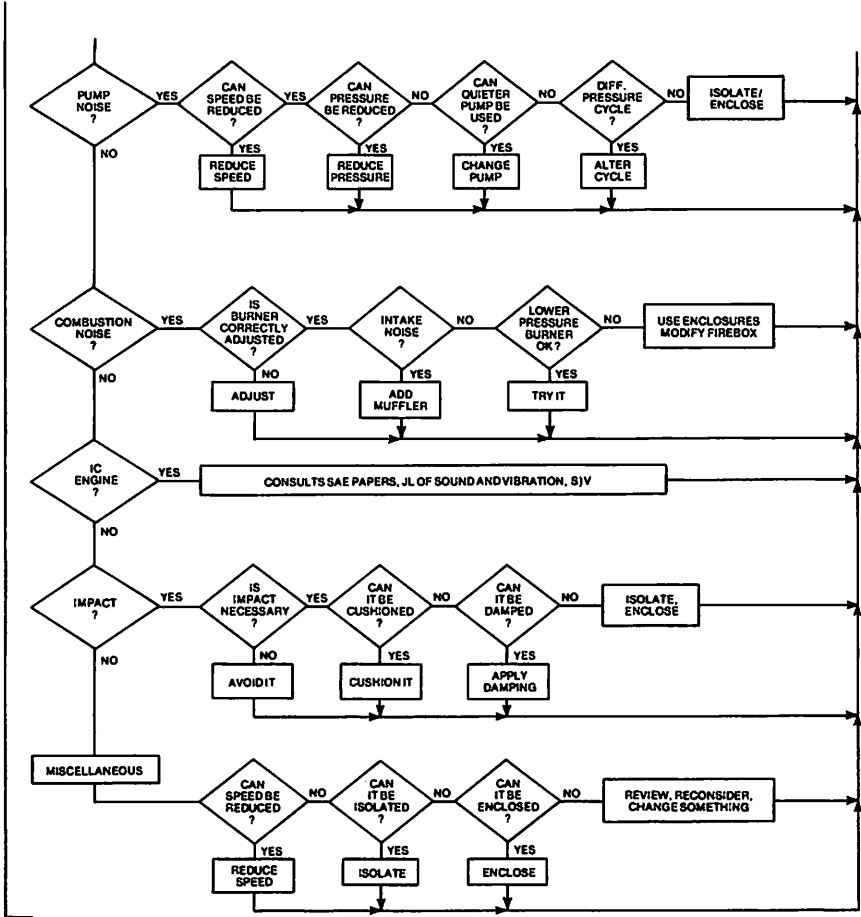

Step 3. If the noise levels are not acceptable, it is often useful to review the basic result to be achieved and various methods of achieving them, with regard to their noisiness. For example, squeeze methods are quieter than impact methods. Welding is quieter than riveting. In other words, should a different approach be taken?

Step 4. Identify the major sources of noise. Many machines are systems consisting of assemblies of several devices. These may be a motor drive, a power transmission system, a cooling or ventilating system, and an assembly that is characteristic of the machine. Which of these devices is the major source of noise can usually be identified by the spectrum of the noise, by techniques of isolating the various parts of the machine, or by the location of the maximum levels in relation to the parts of the machine.

If a weighting is used for the specification, for example A-weighting, its effect should be taken into account when deciding which sources are the most important. Thus, A-weighting deemphasizes a 120 Hz component by about 16 dB compared to the response at 1000 Hz, and this difference must be considered in comparing the measured spectra.

Step 5. Identify the nature of the noise. Here the various possible noise generating mechanisms are considered in the light of the characteristics of the most important regions of the spectrum. If the spectrum shows strong discrete components, these may be related to gear contact rates, blade passage frequencies, magnetically generated noise, or rotor vibration and thus lead to identification of the noise generating mechanism directly. If the noise problem is mainly from random noise, it may be gas or fluid flow.

For any of these generating mechanisms, the noise is radiated by acoustic coupling to the air. Often this coupling is through a vibrating panel or frame. This radiation may be reduced by working on the panel or frame, by working on the force, or by isolating the radiating element from the force. If the force is one of a generating mechanism that can be modified, it is one of the items to be considered in the control process.

Step 6. Reduce the noise from one or more of the significant sources. Many ways of doing this are given in the extensive literature on the subject (see references at the end of this chapter and Chapter 17). Some of these ways are outlined in the flow chart.

Step 7. When the noise from one or more significant sources has been reduced, the overall noise is measured again to see if adequate control has been achieved. If not, further noise control procedures are applied. Now the sources that were originally considered of secondary importance may have become significant if the previously designated major sources have been sufficiently quieted.

Such a systematic approach to the problem of product noise quieting will help to achieve the desired goal of a quiet product. In proceeding toward this goal, the various noise control measures that can be used need to be carefully reviewed. The particular measures chosen are often dictated by production costs and customer acceptability.

16.6 VIBRATION REDUCTION.

The basic procedure for vibration reduction will be described briefly. Many specialized techniques have been developed also, and a complete summary of these is impractical here. More extensive information on vibration reduction will be found in the references.

The first step is usually a careful inspection to see if a common-sense, simple, quick solution is available. A part may be loose or broken, and fastening it or replacing it may cure the trouble. If a solution is not obvious, a systematic approach to the problem is suggested.

The approach to reducing vibration is summarized as follows:

1. Change source or coupling to vibrational driving force.
 - Reduce its strength.
 - Eliminate it by substitution, or otherwise.
 - Isolate it.
 - Change its character, frequency (speed).
2. Reduce response to driving force.
 - Insert isolating members.
 - Damp vibrating elements.
 - Detune resonant systems.
 - Change mass. Increase mass of stationary elements or reduce mass of moving elements.
 - Change stiffness.
 - Add auxiliary mass damping or resonant absorbers.

16.6.1 Changing the Driving Force. In order to see how the driving force can be changed, it is useful to review the many ways that a vibratory force is developed. Here there are two basic processes involved. Either mechanical energy of some type is coupled into mechanical vibratory energy by one or more methods, or energy in some other form is transformed into mechanical vibratory energy, as outlined below.

1. Mechanical
 - Unbalanced rotating masses.
 - Reciprocating masses.
 - Fluctuating mechanical forces or torques.
 - Fluctuating loads.
 - Fluctuating mass or stiffness.
 - Poorly formed moving components.
 - Mechanical looseness.
 - Misalignment.
 - Relative motion of two or more components.
2. Transformation from another form of energy.
 - Varying electrical fields.
 - Varying hydraulic forces.
 - Aerodynamic forces.
 - Acoustic excitation.
 - Varying thermal conditions.

Sometimes the source of the vibratory force is readily apparent or well known from experience. At other times use of some measuring instruments can be invaluable in tracking down sources.

Here are some examples:

Stroboscopic observation of a cam and follower showed that above a certain speed the follower did not remain in contact with the cam during parts of the cycle. When the cam periodically came into contact with the follower after the period of separation, a serious impact occurred, which resulted in excessive vibration and noise. (Figure 16-3).

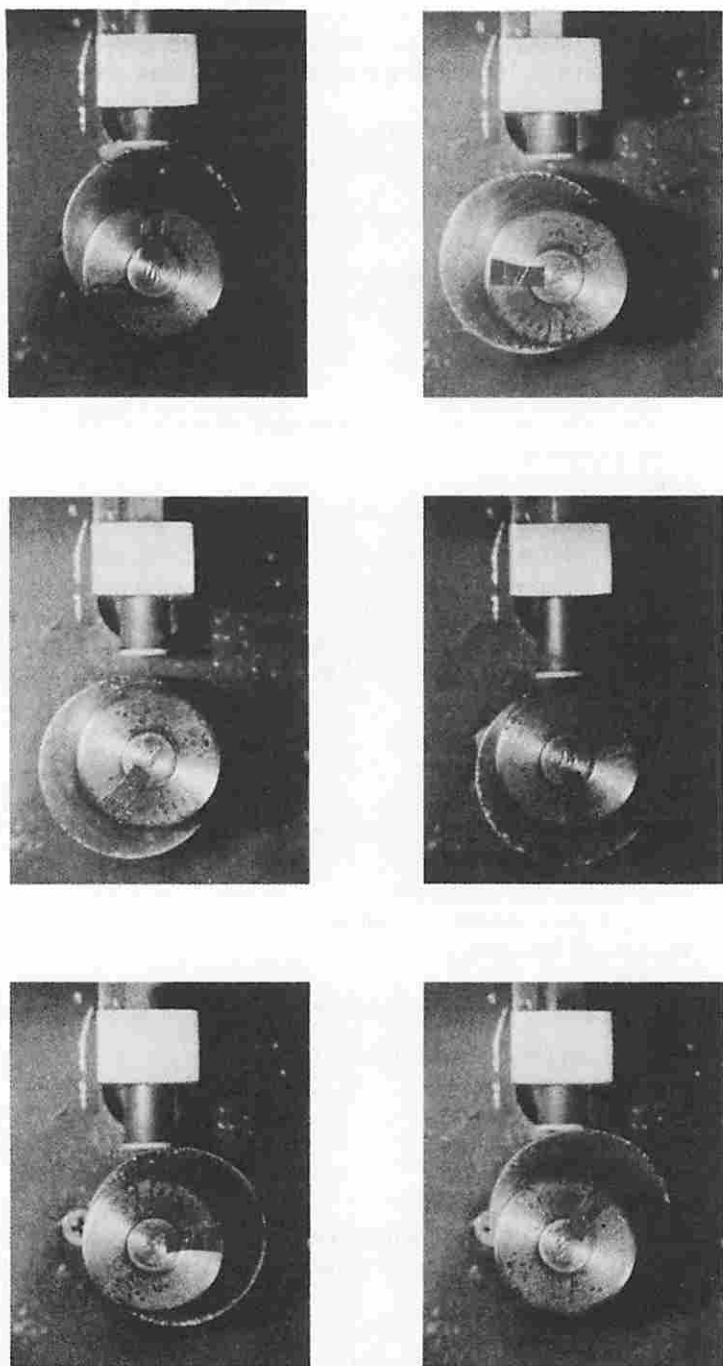

Figure 16-3. Sequence of photographs showing misbehaving cam and follower. The cam is rotating at 2000 rpm. The photographs were taken with stroboscopic illumination at different phases of the cam cycle to show the bouncing action when the cam rotates above a critical speed.

A frequency analysis of a vibration often shows up strong components whose frequencies can be related to certain shaft speeds or gear-tooth meshing frequencies, and in this way the source can be tracked down. Sometimes, however, the relations are not simple. As pointed out by L.S. Wirt (1962) the gear-tooth meshing frequency may be modulated at rates determined by shaft speeds, because of run out, and by the rate at which the torsional loading varies (Figure 16-4).

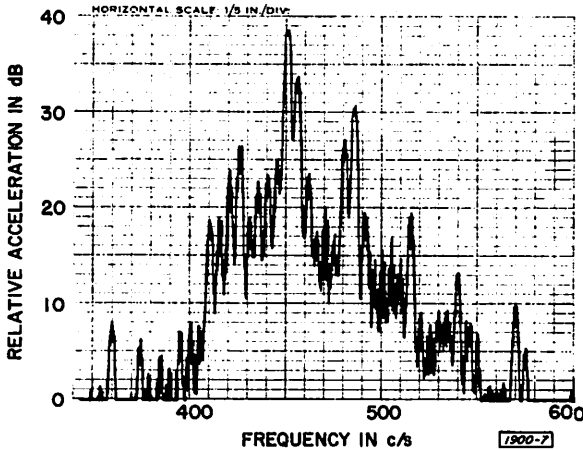

Figure 16-4. A part of the recorded frequency analysis of the vibration of a gear-belt drive. The tooth-contact rate of 450 impacts per second determines the frequency of the dominating component, and the gear belt with its speed of 5 rps introduces a host of components spaced about the main component by multiples of 5 hertz. The torque pulsations from the 1800 rpm synchronous motor and the 120-Hz magnetically driven vibration in the motor also influence the spectrum.

For devices that are electrically driven, strong vibration components at frequencies that are multiples of 120 Hz are good indications that these vibration components are electro-magnetically excited. Sometimes one can check this deduction by monitoring the level of such components, first when the device is operating normally, and then when the electric power is suddenly disconnected. Usually the driven devices will coast long enough so that the mechanical forces will not change rapidly even though the electrical forces are changed abruptly.

When a device can be driven at varying speeds, the effect of changed speeds on the frequencies and amplitudes of the various important components can be an important clue in tracking down the sources of those components. Here the changes in shaft speeds and mesh frequencies can be related to changing or steady frequencies. This technique is particularly helpful if the relative speeds of some parts can be changed or if a clutch can be used to deactivate some sections.

When the indication on the meter of a vibration meter or of a broad-band analyzer fluctuates erratically over a range of 2 to 1 (6 dB) or more, the vibration is usually random in character, and the source is then probably to be found in some rattle, friction-induced vibration, turbulence, poor ball bearings, gases or liquids in motion, or combustion processes. The relative value of a peak and average reading also serves to differentiate this type of vibration from the simpler harmonic motion of rotating unbalanced masses. For simple harmonic motion

the peak value will be about 1.5 times the average value (and the peak-to-peak, about 3 times). For random signals the ratio is usually much higher, that is 3 to 4 times (or 6 to 8 times for peak-to-peak).

Listening by means of a pair of earphones to the signal picked up by the vibration pickup can be helpful in determining the cause of a vibration, particularly if the source is defective ball or needle bearings or air leaks, which give a rough quality to the sound. The earphones should have a good pair of ear cushions or muffs to keep out extraneous sound.

Once the mechanism producing the vibratory force is recognized, a review of the possible means for reducing the force is in order. Thus, balancing techniques can be applied, better gears or bearings can be substituted, proper lubrication can be applied, the mechanical structure can be improved (for example by lightening the moving members and increasing the weight of stationary members), and gas or liquid velocities can be reduced.

16.6.2 Balancing Rotating Machinery. Unbalance in rotating devices is one of the chief causes of excessive vibration. This single cause is so important that extensive discussions of it will be found in a number of the books listed at the end of this chapter. See, for example, Muster and Senger (1961), Wilcox (1967), and Loewy and Piarulli (1969).

Balancing criteria and current practice have been reviewed by Muster and Flores (1969). The degree of balance that is sought depends on the type of device, its applications, and the rotor speed. The highest quality of balance is required for gyroscopes and precision grinders, and the poorest quality is tolerated for the crankshaft drives of slow, rigidly mounted engines. A standard has been published by the International Standards Organization for recommended allowable degrees of unbalance, and some indirect criteria have been published in terms of acceptable vibration at a bearing housing.

16.6.3 Shaft Misalignment. When rotating devices are coupled together, they need to be accurately aligned or serious vibration related problems may occur (Hagler et al, 1979). Flexible couplings can help in reducing the effects of residual misalignment. Vibration measurements are helpful in checking alignment, particularly under various load and thermal conditions.

16.6.4 Reducing Response to Driving Force. A further important step in the process of vibration reduction is to reduce the response to the driving force (Morrow, 1963, pp 56 ff). Here, too, measurement techniques can be valuable in guiding the approach to reducing the response. For example, exploring for maxima in vibration level may show up resonance modes of vibrations of plates and other structural members. It can show where damping may be most effective or where resonant absorbers can be added. It may also show where detuning can be used.

Resonance Effects. The phenomenon of resonant vibration occurs frequently; for example, resonant vibration is essential to the operation of most musical instruments. The undesired resonances in some automobiles at certain speeds can be very annoying.

The effects of resonant vibration in rotating machinery can be so serious that the design of these devices includes the calculation of the critical speeds (resonance frequencies). These calculations are used to make certain that whenever possible, the critical speeds are not included in the normal operating range of the device.

The resonance or natural modes of vibration for many types of simple structures have been calculated. Some of these are beams, shafts, plates, and stretched wires. The frequencies of resonance depend, for example, on the shape, dimensions, stresses, mounting, and material characteristics. The frequencies can also be affected by coupling to other structures.

The nature of resonance is readily illustrated by vibration of a table on which a mass is flexibly mounted with the table driven at a constant amplitude but at different frequencies. At a certain critical frequency the motion of the mass will be greater than for frequencies just slightly higher and slightly lower. This frequency at which a maximum in vibration occurs is a resonance frequency. If the structure being shaken is relatively complex, many such maxima can be observed. (It is often helpful to use a stroboscopic technique to make this motion visible at a slowed-down rate.) Minima of motion may also be due to resonances.

In an actual operating device, resonant conditions may be obvious because of excessive noise or observed vibration at certain speeds. Exploring by means of a vibration pickup, for the points at which vibration is much greater than for other places on the device, will often locate the resonance elements. The resonances may be of the simple type where a mass is mounted on a flexible support, or they may be of the plate-mode type, where the mass and flexibility of a plate or sheet are in resonance, so that different parts of the plate are moving differently. In this latter instance very complicated motions may result.

Unless there is some significant dissipation of energy (damping) as the system vibrates, the resonance amplitude of motion may become very large, even with a relatively small driving force. These large amplitudes must ordinarily be avoided. The two principal ways of reducing these amplitudes are detuning and damping. If the driving force is at a relatively fixed frequency, it may be relatively easy to move the frequency of resonance out of the operating range by a change of the resonant-element mass or stiffness or both. The use of damping devices or highly damped materials is the other important possibility.

Many techniques for damping vibration have been developed. They include dashpots and other viscous absorbing systems, mastic coatings, sandwich-type dissipative materials, inherently dissipative plastics or metals, electromagnetic damping, frictional rubbing devices, and dynamic absorbers (Lazan, 1968; Kohl, 1973; Nielsen, 1975).

Measurements of the vibration levels at various parts of the device under study can help to show where damping devices can be applied most effectively. Thus if a resonance condition is to be damped, an analyzer tuned to the frequency of resonance should be used on the output of a pickup. Then when the measurements are made at different points on the vibrating device, only the vibration component at the resonance frequency will be observed, so that the actual resonance maxima can be obtained without being obscured by high-amplitude low-frequency vibrations. When such measurements are made, the vibration pickup must be light in weight compared with the mass of the resonant element, so that it does not appreciably detune the resonant system. Whenever possible stroboscopic observations should be made, since this can be done without affecting the vibration.

As an example of the effectiveness of damping in reducing vibration, Ruzicka (1964) reports on an aluminum chassis for electronic modules that was giving trouble because of fatigue failures and incorrect operation because of the collision of modules during vibration of the chassis. The installation of stiffening

plates made of visco-elastic-damped material reduced the vibration amplification at the main resonance modes by factors of 3 to 4, and the vibration-caused problems were eliminated.

Oscillating Conditions. In most instances resonance is exhibited when the natural-mode frequency of a vibrating member coincides with, or is very close to, one of the component frequencies of the driving force. Certain unstable systems, however, do not require this coincidence when the conditions make the system self-oscillatory. They require what is essentially a reasonably steady driving force. Galloping transmission lines and some forms of machine-tool chatter, electrical brush squeal and automobile shimmy are examples of this type of excitation.

The galloping and torsional oscillations in some suspension bridges are aerodynamically induced forms of vibration. Such torsional oscillations destroyed the first Tacoma Narrows Bridge on November 7, 1940. The proper aerodynamic design of such a structure can essentially eliminate this vibration (Steinman, 1956).

The Mackinac Bridge is a classic example of the possible tremendous value that can accrue from careful control of vibration. In its design the vibratory driving force produced by wind was made essentially zero by the particular open structure used. This new design also made possible great savings in the structure. As an additional precaution the deck openings and roadway are arranged to damp any vibration that may occur.

Variation of Parameters. In any of these procedures for tracking down vibration troubles, it is often helpful to change some element, for example the mass, and observe how the change affects the vibration levels. This technique can be classed as the method of variation of parameters. In other words, change things and see what happens. The way of "seeing" is, of course, to use measurements that will give a good basis for judging what has changed and by how much. In general, one follows a logical guessing procedure. The results of the experiments help one to eliminate or confirm the various possible sources of vibration effects.

16.6.5 Vibration Isolation. The reduction of the effects of vibration by isolation is widely used (Crede, 1951; Den Hartog, 1956; Vigness, 1965; SAE Committee G-S, 1962; Seven & Pilkey, 1971). This isolation technique is usually illustrated with a vibrating device mounted on a foundation by means of soft springs or other resilient devices. If the isolation system is properly designed, the vibratory force transmitted to the foundation will be less when the springs are used than when the device is clamped directly to a foundation. The device itself, however, will ordinarily vibrate with a greater amplitude when mounted on a soft mount. Thus it is essential to realize that the isolation is working in only one direction, that is, the original source of vibratory force is not reduced by this isolation. Of course, if the foundation is vibrating as a result of some other driving force, one can reduce the effects of the vibration on a device by suspending it on a suitable soft mount. Some scientific instruments must be isolated in this way from building vibrations in order to operate satisfactorily.

Many commercial vibration isolators, or shock mounts, are available, and the manufacturers of these mounts usually supply information for their proper use. It is most important in applying isolators to avoid having the natural frequency of the mass of the device and the resilient suspension be nearly the same as the frequency of the driving force. When such a condition occurs, the transmitted vibration may be greater with the use of isolators than without. A frequency analysis

of the vibration, which gives the component frequencies of the driving force, and a knowledge of the mechanical constants should make it possible to avoid this simple resonance effect.

Supports should be located to avoid cross coupling from one mode of vibration to another. Such a requirement ordinarily means that the line of action of the support should pass through the center of gravity of the device being supported.

The foundation, the isolating suspension system, and the supported structure will have, individually and in combination, resonant modes at frequencies higher than the first natural resonance. Sometimes these higher modes cause trouble, because the isolation is reduced from that normally expected (Plunkett, 1958).

The usual commercial vibration isolators include sufficient damping so that effects of the higher-order resonances in the isolator are not serious. But the isolation is usually significantly less at high frequencies than one would expect on the basis of the simple idea of a weight supported on a spring.

Torsional vibration is isolated by the use of flexible couplings, flexible shafts, and belts. These, too, include some damping, and they also introduce resonant modes of torsional vibration in conjunction with the rotational inertia of the coupled system.

Multiple isolators need careful design in order to be effective. When two isolator units are used in cascade, serious effects that interfere with satisfactory isolation may occur (Skudrzyk, 1959).

16.6.6 Maintenance. When maintenance of proper performance or acceptable noise and vibration levels is the goal, symptoms are used as a guide to discover the source of any trouble that may develop and to decide on the remedy. Before these symptoms are reviewed, it is also helpful to keep in mind the many ways that machine performance is affected by changes that occur with time. A systematic classification of the sources of these changes should serve to point up the many possibilities that exist. They are:

1. Wear
2. Erosion
3. Corrosion
4. Aging
 - Curing
 - Crystalization and fatigue
 - Solidifying of grease or packing
 - Loss of adhesion or bonding
5. Inelastic behavior
 - Parts stressed out of shape
 - Bent parts
 - Increased tolerances
6. Loosening of fastenings
7. Broken or damaged parts
8. Incorrect or inadequate lubrication
9. Foreign matter
 - Dirt, chips, dust, grit
 - Contaminants

- Humidity
- Ice accumulation
- Paint and other finishes
- 10. Environmental changes
 - Temperature
 - Humidity
 - Pressure
- 11. Chemical changes in materials

The existence of a vibration problem may be first noticed in a routine survey of the vibration levels on the machines in a plant, or it may become evident the performance of a machine may be obviously not so good as it should be. In either situation the usual first step in tracking down the trouble is to locate the point or area where the vibration level is the highest. Inspection at this point may show the real source of the trouble. It is important to remember, however, that vibration is transmitted very readily by metal, and occasionally the point at which the trouble is best corrected is some distance from the point of maximum vibration.

The next step in the search is often a study of the character of the vibration signal, that is, the dominant frequency (low or high), whether it is a tone, random in nature (a rough, rushing or roaring noise in the earphones at the output of a vibration meter), or an impact-type vibration.

The measurement of displacement tends to emphasize low-frequency vibration, and acceleration emphasizes high-frequency vibration. Thus a vibration meter that can measure both these quantities in addition to velocity is helpful in diagnosis. When high-frequency vibration or impact vibration is significant, listening to the character of the vibration signal can often provide an additional clue. For example, poor ball bearings have a characteristic rough tone that may wax and wane.

The nature of the vibration can be organized into three broad classes with a host of possible faults. By the use of the position information and the possible pertinent faults listed in the following classification, one may be able to track down the specific fault in a given case. Or at most only a few possibilities need to be considered and a process of elimination used. For a specific machine, the following list, if not pertinent, at least, may suggest the possibilities that must be considered.

1. Low-frequency vibration (frequency of order of shaft or belt speeds)
 - Unbalanced rotor (worn, eroded, broken, or corroded parts)
 - Misalignment (induces significant axial vibration)
 - Eccentric shafts
 - Slipping clutches
 - Mechanical looseness
 - Loose foundation bolts
 - Oil whirl ($\frac{1}{2}$ or less times shaft speed)
 - Friction whip
 - Worn belts
 - Belts and pulleys out of adjustment
 - Aerodynamically driven galloping and twisting
 - Changed reciprocating elements that introduce added torsional vibration

2. High-frequency vibration

- Defective bearings (random or rough vibration)
- Inadequate lubrication
- Poor gears
- Slipping clutches
- Rubbing or binding parts
- Air leaks
- Hydraulic leaks

3. Impact vibration and rattles

- Parts colliding
- Broken or loose pieces
- Electromagnetically driven loose pieces
- Water hammer
- Surge

In addition to position, frequency, and character of the vibration, timing may also furnish an important clue to the nature of the difficulty. Here, stroboscopic observation with a photoelectric pickoff to trigger the stroboscope can be helpful, as illustrated by the cam and follower study previously mentioned.

When stroboscopic observation is not possible, the vibration signal may be observed on an oscilloscope with timing supplied by the photoelectric pickoff.

16.7 HOW A NOISE OR VIBRATION SPECTRUM IS RELATED TO SOURCES.

As described earlier, the analysis of sound or vibration provides clues to the sources of the significant components of the sound or vibration. When the sources are known, it is often possible to reduce the amplitude of the components by correcting the cause that leads to the excessive amplitude. This corrective action may be a part of a noise reduction program, or a preventive maintenance procedure or in a production run it may be part of saving a faulty machine.

Often faulty operation is likely to be found by a vibration measurement, but sometimes sound picked up by a microphone close to a machine will show certain effects that are hidden in a vibration signal (Enochson et al., 1978). With vibration measurements all 3 orthogonal directions should be explored. On a bearing these would be two radial and the axial directions.

The points at which vibration or noise is a maximum can sometimes help in locating the source of excessive noise, but an understanding of the relation between the observed spectrum components and the operation of machinery elements is often necessary. The following description of many of these relations should help in the use of frequency clues for noise and vibration reduction. Table 16-4 is a summary of these relations (see also Fox, 1977).

Table 16-4

Table relating spectrum components and possible causes

| Component Frequency | Usual Cause | Other Possibilities |
|----------------------------|---|--|
| Shaft Speed | | |
| < ½ | Oil whirl | Defective drive belt (if pulley speed) Vibration from other machines or slower speed components Gear train modulation Friction whip (if speed > critical) |
| Between ½ & 1 | Defective drive belt | Friction whip (if speed > critical) Vibration from other sources Gear train modulation Bent shaft |
| 1 | Unbalance (radial motion) Misalignment (axial motion also) | Defective drive belt (if belt speed) Unbalanced magnetic force |
| 2 or 3 | Misalignment Unbalance | Mechanical looseness Bent shaft Defective drive belt |
| > 3 | Bad gears Cam impulses Fan vibration Reciprocating actions Hydraulic forces | Parts colliding Broken pieces |
| Non integer | Bad gears | Gears on other shafts Modulation of gear vibration Toothed belts with modulation by belt speed Aerodynamically driven galloping |
| High non-integer | Bad bearings | Friction induced vibration Chatter Rubbing Induction motor vibration Slipping clutches |
| Broad band | Aerodynamic Fluid Flow Air leaks Hydraulic leaks | |

Component frequency

| A-C Line frequency | Usual Cause | Other possibilities |
|---------------------------|--|--------------------------------|
| 1 × | Defective motor rotor | Unbalanced phases (electrical) |
| 2 or higher | Magnetostriction Defective electrical components Distorted electrical wave | Loose laminations |

16.7.1 Shafts and rotors. A shaft and its associated rotors will vibrate torsionally, laterally, longitudinally, and in rocking motions. Which of these are important depends on the nature of the driving forces and the dynamic behavior of the shaft and associated structure. The relations of the driving force frequencies to the resonance (critical) frequencies of the mechanical system are particularly important. For example, an internal combustion engine with its crankshaft and associated moving parts is particularly susceptible to torsional vibration problems, and an operating speed that includes excitation of a torsional resonance may lead to severe vibration unless the system has been carefully damped.

Unbalanced rotors produce a vibratory force at the rotational frequency $f_r = \text{RPM}/60$, where RPM is the rotor speed in revolutions/minute, and f_r is the rotor speed in revolutions/second. This force produces a vibration at the supporting bearings in all directions perpendicular to the shaft axis. Higher order unbalance vibrations are also possible. Coupling misalignment will usually introduce a component at twice the shaft speed, but sometimes at the shaft speed. Misalignment will usually lead to relatively large axial vibrations. A bent shaft will produce a component at the shaft speed, but sometimes at 2 or 3 times the shaft speed. Mechanical looseness may introduce a component at twice the rotational speed (Carmody, 1972). Asymmetries in rotating shaft systems can lead to excitation of unstable orbiting, or vibration at frequencies that are not simply related to the shaft speed. These frequencies depend on the behavior at various modes of vibration of the rotor system (Loewy and Piarulli, 1969; Shapiro and Benes, 1972).

Friction in a rotor system can also lead to excitation of a vibration at a frequency corresponding essentially to a rotor resonance (critical) frequency. This vibration is sometimes called whipping or friction whip, and it can occur when the rotor speed is above a critical speed. The frequency of the whipping does not vary noticeably with rotor speed (Buscarello, 1968; Loewy and Piarulli, 1969).

If a shaft is supported in a sliding bearing, it can also, for a limited range of conditions, vibrate at slightly less than one half the rotation rate. This action, sometimes called oil whirl or oil whip, is described in the section on bearings.

The elements mounted on the shaft, for example, gears, bearings, fans, etc., contribute vibratory forces that are considered separately below.

16.7.2 Rolling element bearings — Ball bearings. Many components of vibration are generated by rolling element bearings. When a bearing is in excellent condition, the amplitudes of these components are often so small that they are masked by other vibrations in a structure; but at the bearing housing the vibration may be large enough to be measured at frequencies near the race vibrational resonances. When a bearing is defective, components in those frequency ranges become even more significant (Drosjack and Housen, 1974). This increased vibration at race resonances is sometimes called "ringing."

The basic component forcing frequencies with a stationary outer race are (Babkin and Anderson, 1973)

$$\begin{array}{l} \text{Outer race defect} \quad \frac{knS}{2} \left(1 - \frac{d}{D} \cos \beta\right) \\ \\ \text{Inner race} \left\{ \begin{array}{ll} \text{Eccentricity} & S \\ \text{Rough Spot} & \frac{knS}{2} \left(1 + \frac{d}{D} \cos \beta\right) \\ \text{Waviness} & \frac{knS}{2} \left(1 + \frac{d}{D} \cos \beta\right) \pm S \end{array} \right. \end{array}$$

$$\text{Ball} \left\{ \begin{array}{ll} \text{Diameter variation} & \frac{S}{2} \left(1 - \frac{d}{D} \cos \beta\right) \\ \text{Rough Spot} & kS \frac{D}{d} \left[1 - \left(\frac{d}{D}\right)^2 \cos^2 \beta\right] \\ \text{Waviness} & kS \frac{D}{d} \left[1 - \left(\frac{d}{D}\right)^2 \cos^2 \beta\right] \pm \frac{S}{2} \left(1 - \frac{d}{D} \cos \beta\right) \end{array} \right.$$

where S = operating speed, rps

n = No. of balls

d = diameter of rolling element, } use same units for each

D = bearing pitch diameter,

β = contact angle of the balls to raceway

k = 1, 2, 3, ... harmonic order

The basic ball resonance frequency is

$$f_{BR} = \frac{0.848}{d} \sqrt{\frac{E}{2\rho}}$$

where d = diameter of ball (cm), E = modulus of elasticity N/cm², ρ = density of ball (kg/cm³), and the vibrational resonance frequencies of the race are (Drosjack and Housen, 1974; Love, 1944; Martin, 1970):

$$f_{RR} = \frac{k(k^2-1)}{2\pi\sqrt{k^2+1}} \frac{1}{a^2} \sqrt{\frac{EI}{m}}$$

where a = radius to neutral axis, cm

I = moment of inertia of cross section (cm⁴)

E = modulus of elasticity, N/cm²

m = mass of race/linear distance kg/cm

k = 2, 3, 4, ..., number of standing waves around circumference

The lowest of these is

$$f_{RR} \approx \frac{.427}{a^2} \sqrt{\frac{EI}{m}}$$

and it is usually in the range above 5 kHz.

The ball resonance frequency is usually much higher and can usually be ignored.

The basic component forcing frequencies of a ball bearing are much lower than the race frequencies. A number of high-order harmonics will then fall into the range of a race resonance, and they will appear as closely spaced components with an envelope of response determined by the resonance amplification (Drosjack and Housen, 1974). Since these resonances are not dependent on shaft speeds, the appearance of the spectrum envelope in the vicinity of the resonance will not change much with speed.

16.7.3 Sliding bearings. Sliding bearings in good condition and properly lubricated can be much quieter than rolling element bearings and are then rarely important sources of noise or vibration. When lubrication is not adequate, however, they can be very noisy.

Under certain conditions an oil-lubricated journal can vibrate at slightly less than one-half the rotation rate. This action, called oil whip, or half-speed whirl, is a result of the way the oil flows about the shaft to make the shaft precess at nearly one-half the rotation rate. The resulting vibration can be very serious (Buscarello, 1968; Loewy and Puarulli, 1969). The usual ratio of this vibration frequency to the shaft rotation frequency is in the range of 0.40 to 0.49 (Hagg, 1968).

16.7.4 Gears. One of the significant vibratory forces for gears has a fundamental frequency equal to the tooth contact rate, f_T^* .

$$f_T = f_G \cdot N$$

where f_G = rotational speed of gear, rps
and N = No. of gear teeth.

This component is often easily identified in a narrow-band spectrum analysis, but it is only one of many components introduced by gearing.

Gear runout or unbalance produces a force at the shaft rotation frequency. The vibration from gear runout peaks in the direction of a line connecting the centers of the mating gears, with hardly any vibration perpendicular to this direction, and this behavior can sometimes be used to differentiate it from unbalance (Buscarello, 1968). (This effect needs to be considered in selecting the locations of accelerometers on bearing housings.)

The vibratory motion from gear runout and unbalance will modulate the vibratory motion from the tooth contact, and the effect on the spectrum can be dramatic. Components at frequencies that are the sums and differences of integer multiples of the shaft rotation frequency and of the tooth contact rate will appear. To put it in another way, components will be spaced in frequency by the shaft rotation frequencies about the tooth contact frequency and about multiples of the tooth contact frequency (Wirt, 1962; Mitchell and Lynch, 1969). (See Figure 16-4).

These modulation components are significantly affected by teeth with poor profiles or with chipped or broken sections.

***Planetary gear sets**

The tooth contact rates for planetary gear sets depends on what is held fixed.

If the sun gear is fixed, the tooth contact rate, f_T , is the number of teeth on the sun gear, N_s , times the rotation frequency of the planetary cage, S_c .

$$f_T = N_s \times S_c$$

If the planetary cage is fixed, the rate is the number of teeth on the sun gear, N_s , times the rotation frequency of the sun gear, S_s .

$$f_T = N_s \times S_s$$

If the annulus gear is fixed, the rate is

$$f_T = S_s \times \frac{N_s \times N_a}{N_s + N_a}$$

where N_a is the number of teeth in the annulus gear, and the other symbols are those already defined (Dunlap and Halvorsen, 1972).

The component at the tooth contact frequency will not always dominate. Sometimes the runout is sufficiently large compared to the gear tooth variations that the modulation can cause the component at the tooth contact frequency to be relatively small.

Resonances in the intervening structure, that is, shafts and gear case, may greatly accentuate one or more of these components. This combination of many components in the driving function and the mechanical resonance can lead to severe and damaging vibrations or at least to excessive wear and noise (Rieger, 1969).

A gear will also have a "ghost" gear with an apparent number of teeth determined by the master wheel on the hobbing machine, because of inaccuracies in the master wheel. This "ghost" gear may then produce spectrum components that are not so simply related to the tooth contact frequency (Mitchell and Lynch, 1969; Bradley, 1973).

The identification of all these components is only feasible with a detailed spectrum analysis, and it is also helpful, but not always essential, to have the gear train driven at a fixed and accurately known speed. Then it is usually possible to sort out the many components by careful calculation of their frequencies.

16.7.5 Cams. When cams are used to drive mechanical parts, there is a basic vibration at the cam rotation speed. If the accelerations that are applied are great enough, surfaces may impact one another with a repetition rate equal to the cam rotation speed. Such impacts introduce vibration and noise components extending over a wide frequency range to high multiples of the repetition rate. As a result of resonance ringing of impacted parts some of these components may become large in amplitude and very bothersome.

16.7.6 Fans, air moving systems, and turbo machinery. Fan noise includes blade noise, noise from the moving air, mechanical noise from the bearings, the structure and moving parts, and motor noise.

Discrete components can be expected at the blade passage frequency, which is the number of blades times the rotating speed in rps, and at integer multiples of that frequency (Hanson, 1974; Hanson, 1973; Kenny, 1968; Smith et al., 1974). Lower amplitude components can be found at multiples of the shaft speed, and these are probably a result of geometric variations in the rotor structure, and they can extend over a very wide frequency range (Kantola and Kurosaka, 1972; Kurosaka, 1971) especially for high speed fans. Because of the discrete components, a narrow band analysis is essential here.

In addition to these discrete components there is a wideband random noise produced by air turbulence and vortex shedding (See 16.7.8).

The mechanical noise and motor noise are discussed in other parts of this section.

In turbomachinery with rotors having stages with differing numbers of blades, discrete tones at the blade passage frequencies and at frequencies that are sums and differences of integer multiples of these frequencies can occur (Cumptsy, 1974).

16.7.7 Hydraulic pumps. Hydraulic pumps have noise and vibration components at integer multiples of the pumping frequency, which is equal to the shaft rotational frequency multiplied by the number of pistons or pumping elements. The harmonic components may be strong even at relatively high orders; in addi-

tion, there is a broadband random noise from cavitation, turbulent flow, and impact. The hydraulic fluid pressure pulsations produced by the pumping mechanism are transmitted through the hydraulic lines and may cause noise and vibration problems far from the pump itself (Skaistis et al., 1964).

In the analysis of hydraulic system noise it is helpful to have good resolution and to sum a large number of autospectral values for good stability in rating the random noise as well as the discrete components (Sullivan, 1967).

16.7.8 Noise from gas flow. Most gas flow noise is random in nature, and it has a broad spectrum. The spectrum level tends to increase slowly with frequency, reaching a broad peak and then dropping rapidly; but this behavior can be modified greatly by the acoustical characteristics of the system and space under consideration. The frequency at which the spectrum level peak occurs can be estimated for some simple situations.

For a free jet stream, the peak occurs at about

$$f_p = 0.15 \frac{\nu}{D_N}$$

where ν is the gas velocity in m/sec., and D_N is the diameter of the nozzle in m. (Heller and Franken in Beranek, 1971).

For the usual diffusers on a duct, the spectrum level of the noise radiated peaks at a frequency of about

$$f_p = 60 \times \nu \text{ where } \nu \text{ is the air velocity in m/sec.}$$

Musical wind instruments are important exceptions to the expected broad spectrum noise. Here the acoustical characteristics of the instruments control the sound generation to be essentially discrete tones (Olson, 1967; and Wood and Bowsher, 1975). Flow in some pipe structures may lead to generation of tones in a similar manner.

As a further exception to this broad spectrum noise, a series of circular rods in an air flow may produce sound at a discrete frequency of approximately

$$f = 0.2 \frac{\nu}{D_R}$$

where ν = mean flow speed, m/sec., and D_R = diameter of the rods, m.

Discrete tones may also be produced by air flow around forms of other shapes, and some of these effects were undetected until the more recent use of narrow-band analysis (Tam, 1974).

16.7.9 Electric Motors. The noise and vibration of an electric motor comes from the magnetic field, windage, and mechanical sources. Of these, windage (fan noise) usually dominates in air cooled motors.

16.7.9.1 Magnetic noise. The magnetic field produces, by magnetostriction, vibrations at even integer multiples of the power line frequency. In addition because of the non-uniformity of the magnetic field introduced by slots, many other components are present. For induction motors, radial harmonic forces of the air gap field produce vibrations with components having frequencies, f_n , that

depend on the number of rotor slots, Q_R , the number of poles, P , the slip, S , and the line frequency f_L .

$$f_v = 2 \left(\frac{kQ_R}{P} (1 - s) \pm \ell \right) \times f_L$$

where the indexes k and ℓ are selected independently from the set 0, 1, 2, 3, ...

The particular components that are significant depend on the number of stator slots, rotor slots, poles, winding connections, and the mechanical vibration response of the stator (Alger, 1970; Fehr and Muster, 1957; Costa, 1968).

In medium size motors, particularly, the vibration may be accentuated by mechanical resonances of the stator core (Marup-Jensen, 1961). The acoustic noise level that results from this vibration depends on these amplitudes but also on the radiation characteristics of the motor and mounting.

The following table shows the effective numbers of nodes and the corresponding frequencies of the forcing fields for some of the combinations of rotating fields in an induction motor. The table has been simplified to eliminate many components that ordinarily are unimportant.

| Set | Nodes | Frequencies |
|-----|---------------------------------|--|
| A | $2k(Q_s - Q_R) \pm 2\ell P$ | $2f_L \left\{ k \frac{Q_R(1-S)}{P} \pm \ell \right\}$ |
| B | $2k(Q_s - Q_R - P) \pm 2\ell P$ | $2f_L \left\{ k \left[\frac{Q_R(1-S)}{P} + 1 \right] \pm \ell \right\}$ |
| C | $2k(Q_s - Q_R + P) \pm 2\ell P$ | $2f_L \left\{ k \left[\frac{Q_R(1-S)}{P} - 1 \right] \pm \ell \right\}$ |

when Q_s = No. of stator slots

Q_R = No. of rotor slots

P = No. of poles

f_L = line frequency

and the indexes k and ℓ are selected independently from the set 0, 1, 2, 3, ... (The signs selected where \pm is indicated do not have to correspond.)

This set has been selected on the assumption that the number of stator and rotor slots are nearly the same.

One of the steps in considering the likelihood of a mode being significant is to calculate the number of nodes. If the number of nodes that result is large, it is unlikely that the amplitude will be large unless the frequency happens to be a resonance (critical) one. High orders of the indexes are also less likely to be significant, because they correspond to harmonics of the rotating fields; and the harmonics are weaker than the fundamental. Further details of how to assess the relative importance of the components is given in Alger (1970) and Fehr and Muster (1957).

As an example of the multiple components produced by an induction motor, Alger (1970) gives the results of measurements on a 60-Hz, 4 pole motor with 60 stator and 62 rotor slots. The line spectra, shown in Figure 16-5, is redrawn from

his measurements to show only the discrete components. The motor was running with very little slip, and the calculated component frequencies that correspond to those in the figure are deduced from

$$f_v = 2 \left(\frac{k \times 62}{4} \pm \ell \right) \times 60 = 1860 k \pm 120 \ell$$

| k | ℓ | f_v | Nodes |
|---|---------|-------|-------|
| 1 | (-) 1 | 1740 | 4 |
| 1 | 0 | 1860 | 4 |
| 1 | 2 | 2100 | 4 |
| 2 | 0 | 3720 | 8 |
| 2 | 4 | 4200 | 8 |
| 3 | (-) 1 | 5460 | 4 |
| 4 | (-) 1 | 7320 | 8 |

Alger shows that most of the other possible combinations are not significant because they require high order modes of vibration of the stator. The components at 2100 and 4200 are significant because the motor was delta connected, which permitted a strong triple harmonic field, and the corresponding node values are different from those given in the earlier table.

The component at 520 Hz is explained by Alger as due to air gap dissymmetry, which excited a critical shaft frequency. Other components, for example, at 120, 240, 360 Hz, etc., should be present but they were apparently masked by the background noise.

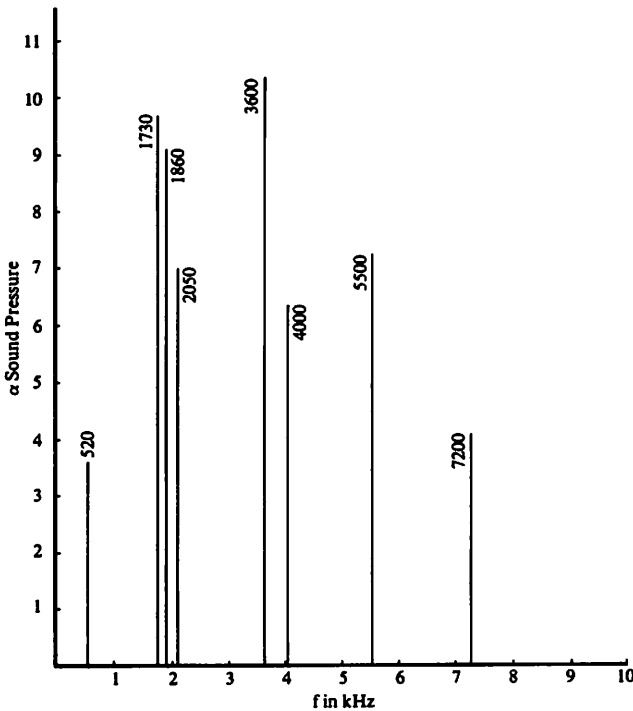

Figure 16-5. The discrete components of noise produced by an induction motor.

Even though an electric motor armature is well balanced, its outside diameter may not be concentric with its axis of rotation. This condition will result in a magnetic force producing a vibration at the bearings at the rotation frequency. Since it is magnetically produced, it will disappear when the electric power is turned off (Buscarello, 1968). The unbalanced magnetic pull may also produce a component at twice the rotational speed (Carmody, 1972).

In synchronous machines, a vibration at twice the rotational speed is to be expected; in d-c machines, a vibration at the number of armature slots times the rotational speed is to be expected (Carmody, 1972).

16.7.9.2 Mechanical noise. The mechanical noise of a motor is often from the bearings, the brushes, and rotor unbalance. Bearing noise is considered separately. Brush noise is usually negligible for a continuous slip ring when both the brush and slip ring are in good condition. With commutators having a number of bars, B , one can expect a vibration and noise at a frequency Bf_r , where f_r is the rotational frequency, and at multiples of that frequency. Under certain conditions brush chatter can develop, see below.

Rotor unbalance produces vibrations at a frequency equal to the rotational frequency:

$$f_r = \text{RPS} = \frac{\text{RPM}}{60}. \text{ (See further discussion under rotors.)}$$

16.7.9.3 Windage. Windage or ventilation noise is that caused by the fan and the airstream in the motor. Fan noise is considered separately. Some machines include radial cooling ducts. With a narrow air gap between rotor and stator, a siren effect may occur when the air passes between the rotor and stator ducts. The basic frequency of this noise is equal to the number of slots times the rotation frequency, and components at integer multiples of this frequency will also be present.

16.7.9.4 Power pulsation — Single phase. The pulsating power delivery of a single-phase a-c supply leads to torsional vibrations in the output drive at twice the line frequency.

16.7.10 Transformers and choke coils. The noise and vibration of transformers in good condition is mainly from magnetostriction, and the component frequencies are even multiples of the power frequency. For a 60-Hz supply, the components are at 120 Hz, 240 Hz, 360 Hz, . . . , and they produce the characteristic hum of a transformer. Which of these are dominant is often a function of the mechanical response characteristics of the transformer core, case, and associated structure. For acoustic noise, the radiation efficiency of the vibrating structure is also important.

Iron-cored choke coils also produce a hum from magnetostriction. Many of them and some transformers, too, have a d-c component in the magnetizing current, and then any integer multiple of the exciting power frequency may be expected.

In some systems, voltage driving a transformer or a choke-coil may not have a frequency equal to the basic supply line frequency. Then, of course, it is the frequency of the driving voltage that determines the magnetostriction vibration. This condition is found frequently in modern electronic equipment and in TV sets.

When the laminations of the iron core of a transformer are not firmly fastened together, a buzzing or rattling noise may result from the laminations hitting each other as they are vibrated by magnetostriction. These impacts may lead to shock excitation of resonances, and the resulting noise may have components over a wide range of frequencies.

The noise from fluorescent lamp ballasts may contain strong components extending out to high multiples of the power line frequency, because of the distorted current wave drawn by the lamps (King, 1957).

16.7.11 Chatter. When metals are cut on machine tools, a serious vibration of the tool and workpiece can develop. This vibration is known as "chatter." The frequency of the chatter is not related to the rotational speed of the workpiece or the tool, but rather to resonant modes in the overall dynamic system (Tobias, 1941; Ota and Kuno, 1974; Kato and Marui, 1974; Koenigsberger and Tlustý, 1970). Since machine tools are not ordinarily operated in this mode, the analysis of the vibration becomes important only when studying the effect in order to avoid it.

Some other systems are subject to related types of vibration, for example, brush chatter in some electrical machines. These vibrations are induced by continuing relative motion of one piece against another, and the frequency of vibration is usually a resonance frequency of the structure.

16.7.12 Internal combustion reciprocating engines. The basic firing frequency, f_f , of a four-cycle engine is $f_f = \text{rps} \times m/2$ where m is the number of cylinders and rps is the shaft rotation speed (Apps, 1957). This fundamental frequency and its harmonics are the main component frequencies to be expected in the exhaust noise and in the vibrations of the shaft. But because the firing of all cylinders is not equal in strength, because pressure in all the cylinders is not identical as a function of time, and because the cylinders are not perfectly evenly spaced, there will be components at multiples of $1/2$ the shaft speed in rps . These latter components are called half-order. In a 2-cycle engine the half-order components should not be present, but they may occur because of poor scavenging.

16.8 Conclusion

If a simple solution is not obvious, the quantitative results of measurements are often essential elements in the efficient analysis and solution of the problem. As various control procedures are used, sound and vibration measurements can show the progress being made and when the attack on the problem must be shifted from one form or place to another.

REFERENCES

(This list includes many general references in addition to the ones cited in the text of this chapter.)

- P.L. Alger (1970), *Induction Machines*, Second edition, Gordon and Breach, London, Chapter 10.
American Foundrymen's Society (1972), *Control of Noise*, Third edition, American Foundrymen's Society, Des Plaines, Illinois.
American Industrial Hygiene Association (1975), *Industrial Noise Manual*, Third edition, AIHA, 66 S. Miller Rd., Akron, OH 44313.

- American Petroleum Institute (1973), *Guidelines to Noise*, Medical Research Report EA7301, API, Washington, D.C.
- American Society of Heating, Refrigerating and Air-Conditioning Engineers, *ASHRAE Handbook of Fundamentals 1972*, Chapter 6, *ASHRAE Handbook and Product Directory 1976 Systems*, Chapter 35, ASHRAE, 345 East 47th Street, New York, NY 10017.
- A.S. Babkin and J.J. Anderson (1973), "Mechanical signature analysis of ball bearings by real time spectrum analysis," *J Environ Sci*, Vol 16, #1, Jan/Feb 1973, pp 9-17 (see also *Sound and Vibration*, Vol 7, #4, April 1973, pp 35-42.)
- L.L. Beranek, ed. (1971), *Noise and Vibration Control*, McGraw-Hill, New York.
- L.L. Beranek, ed. (1960), *Noise Reduction*, McGraw-Hill, New York.
- R.D. Berendt, E.L.R. Corliss, and M.S. Ojalvo (1976), *Quieting: A Practical Guide to Noise Control*, National Bureau of Standards Handbook 119.
- W.A. Bradley (1972), "Sound Gear Quality," *Mechanical Engineering*, Vol 94, #10, Oct 1972, pp 30-36.
- British Internal Combustion Engine Research Association (1958), *A Handbook on Torsional Vibration*, University Press, Cambridge, England.
- R.T. Buscarello (1968), "Practical Solutions to Vibration Problems," *Chemical Engineering*, Vol 75, Aug 12, 1968, pp 157-166.
- T. Carmody (1972), "The measurement of vibration as a diagnostic tool," *Trans Inst of Marine Engineers*, Vol 84, Part 6, 1972, pp 147-159.
- D.P. Costa (1968), "Reduction of electrical machine noise," *Electromechanical Design*, Nov 1968, pp 56-59.
- C.E. Crede (1951), *Vibration and Shock Isolation*, John Wiley & Sons, Inc., New York.
- N.A. Cumptsy (1974), "Sum and difference tones from turbomachinery," *J Sound and Vib*, Vol 32, #3, 8 Feb 1974, pp 383-386.
- J.P. Den Hartog (1956), *Mechanical Vibrations*, McGraw-Hill, New York.
- G.M. Diehl (1974), *Machinery Acoustics*, Wiley-Interscience, N.Y.
- M.J. Drossack and D.R. Houser (1974), "An analysis of vibration diagnostics for helicopter power trains," *Proc 20th International Instrumentation Symposium*, Albuquerque, N.M., Instrument Soc Am, May 21-23, 1974, pp 219-230.
- C. Duerden (1970), *Noise Abatement*, Butterworths, London.
- L. Enochson and G. Smith (1978), "Examples of Digital Data Analysis for Rotating Machinery," National Conference on Power Transmission, Philadelphia, Penn., November 8, 1978.
- R.O. Fehr and D.F. Muster (1957), "Electric Motor and Generator Noise," Chap. 30 in C.M. Harris, ed., *Handbook of Noise Control*, McGraw-Hill, N.Y.
- R.L. Fox (1977), "Preventive maintenance of rotating machinery using vibration detection," *Iron and Steel Engineer*, Vol 54, #4, April 1977, pp 52-60.
- W. Furrer (1964), *Room and Building Acoustics and Noise Abatement*, Butterworth, London.
- A.C. Hagg (1968), "Oil whip," in J.J. O'Conner, J. Boyd, and E.A. Avallone, eds., *Standard Handbook of Lubrication Engineering*, pp 3-11f.
- R. Hagler, H. Schwerdlin and R. Eshleman (1979), "Effects of shaft misalignment on machinery vibration," *Design News*, Vol 35, #2, Jan 22, 1979, pp 38-41.
- D.B. Hanson (1973), "Unified analysis of fan stator noise," *J Acoust Soc Am*, Vol 54, #6, June 1973, pp 1571-1591.
- D.B. Hanson (1974), "Spectrum of rotor noise caused by atmospheric turbulence," *J Acoust Soc Am*, Vol 56, #1, July 1974, pp 110-126.
- C.M. Harris, ed (1979), *Handbook of Noise Control*, second edition, McGraw-Hill, New York.
- C.M. Harris and C.E. Crede, eds (1976), *Shock and Vibration Handbook*, second edition, McGraw-Hill, New York.
- W.M. Ihde (1973), "The application of engineering noise control measures," *National Safety News*, Vol 107, #6, pp 85-100.
- R.A. Kantola and M. Kurosaka (1972), "Theoretical and experimental investigations of multiple pure tone noise," *J of Aircraft*, Vol 9, #11, Nov 1972, pp 784-790.
- S. Kato and E. Marui (1974), "On the cause of regenerative chatter due to workpiece deflection," *J Eng Ind*, Trans ASME, vol 96B, #1, Feb 1974, pp 179-186.
- R.J. Kenny (1968), "Noise in air-moving systems," *Machine Design*, Vol 40, Sept 26, 1968, pp 138-150.
- E.M. Kerwin, Jr., (1959), "Damping of Flexural Waves by a Constrained Viscoelastic Layer," *J Acoust Soc Am*, Vol 31, #5, July, pp 952-962.

- A.J. King (1957), "Reduction of the noise of iron-core transformers and chokes," Chapter 29 in C.M. Harris, ed., *Handbook of Noise Control*, McGraw-Hill, N.Y.
- V.O. Knudsen and C.M. Harris (1950), *Acoustical Designing in Architecture*, John Wiley & Sons, Inc., New York.
- F. Koenigsberger and J. Tlustý (1970), "Stability against chatter," Section 2 of *Machine Tool Structures*, Vol 1, Pergamon Press, Oxford.
- R. Kohl (1973), "Stopping vibration with dynamic dampers," *Machine Design*, Vol 45, #20, Aug 23, 1973, pp 125-129.
- M. Kurosaka (1971), "A note on multiple pure tone noise," *J Sound and Vib*, Vol 19, #4, 22 Dec 1971, pp 453-462.
- G. Kurtze (1964), *Physik und Technik der Larmbekämpfung*, G. Braun, Karlsruhe.
- B.J. Lazan (1968), *Damping of Materials and Members in Structural Mechanics*, Pergamon Press, New York.
- D.M. Lipscomb and A.C. Taylor, Jr., eds (1978), *Noise Control: Handbook of Principles and Practices*, Van Nostrand Reinhold, N.Y.
- R.G. Loewy and V.J. Piarulli (1969), *Dynamics of Rotating Shafts*, Shock and Vibration Monograph series SVM-4, Navy Publication and Printing Service Office, Washington, D.C.
- P. Lord and F.L. Thomas, eds (1963), *Noise Measurement and Control*, Heywood & Company Ltd, London.
- A.E.H. Love (1944), *Treatise on the Mathematical Theory of Elasticity*, Dover, N.Y., pp 284-286, 451-453.
- J.N. MacDuff and J.R. Curreri (1958), *Vibration Control*, McGraw-Hill, New York.
- R.T. McGoldrick (1957), *A Vibration Manual for Engineers*, US Navy, PB131785, December, 2nd edition.
- R.T. McGoldrick (1960), *Ship Vibration*, David Taylor Model Basin Report 1457, December.
- E.B. Magrab (1975), *Environmental Noise Control*, John Wiley, N.Y.
- R.L. Martin (1970), "Detection of ball bearing malfunctions," *Instruments and Control Systems*, Dec 1970, pp 79-82.
- L.D. Mitchell and G.A. Lynch (1969), "Origins of Noise," *Machine Design*, Vol 41, May 1, 1969, pp 174-178.
- C.T. Morrow (1963), *Shock and Vibration Engineering*, John Wiley & Sons, Inc., New York.
- D. Muster and W.I. Senger (1961), "Balancing of Rotating Machinery," Vol 3, Chapter 39, of Harris and Crede (1961).
- D. Muster and B. Flores (1969), "Balancing Criteria and Their Relationship to Current American Practice," *J Engineering for Indus*, Trans ASME, Vol 91, Series B, #4, Nov, pp 1035-1046.
- National Institute for Occupational Safety and Health (1975) *Compendium of Materials for Noise Control*, US Dept of HEW, NIOSH, Cincinnati, OH 45202, Supt of Doc, U.S. Gov't Printing Office, Washington, DC 20402.
- National Physical Laboratory (1962), *The Control of Noise*, Symposium No. 12, Her Majesty's Stationery Office, London.
- L.E. Nielsen (1975), "Mechanical damping of filled plastics," *Shock and Vibration Digest*, Vol 7, #2, Feb 1975, pp 76-86.
- H.F. Olson (1967), *Music Physics and Engineering*, Dover Publications, N.Y., 2nd edition.
- H. Ota and K. Kono (1974), "On chatter vibrations of machine tool or work due to regenerative effect and time lag," *J Eng Ind*, Trans ASME, Vol 96B, #4, Nov 1974, pp 1337-1346.
- P.H. Parkin and H.R. Humphreys (1963), *Acoustics, Noise, and Buildings*, Faber and Faber, London, 2nd edition.
- R. Plunkett (1958), "Interaction Between a Vibratory Machine and Its Foundation," *Noise Control*, Vol 4, #1, Jan, pp 18-22.
- M. Rettinger (1968), *Acoustics, Room Design and Noise Control*, Chemical Publishing Co., New York.
- N.F. Rieger (1965), "Vibration in geared systems," *Machine Design*, Vol 37, Sept 16, 1965, pp 164-173.
- D. Ross, E.E. Ungar, and E.M. Kerwin, Jr. (1959), "Damping of Plate Flexural Vibrations by Means of Viscoelastic Laminae," in Ruzicka (1959).
- J.E. Ruzicka, ed (1959), *Structural Damping*, American Society of Mechanical Engineers, New York, N.Y.

- J.E. Ruzicka (1964), "Vibration Control: Applications," *Electro-Technology*, Vol 73, #1, Jan, pp 75-82.
- J.E. Ruzicka (1971), "Fundamental Concepts of Vibration Control," *J Sound and Vib*, Vol 5, #7, July 1971, pp 16-23.
- H.J. Sabine (1950), *Less Noise — Better Hearing*, Celotex Corporation, Chicago.
- SAE Committee G-S (1962), Aerospace Shock and Vibration, *Design of Vibration Isolation Systems*, Society of Automotive Engineers, New York.
- V. Salmon, J.S. Mills, and A.C. Petersen (1975), *Industrial Noise Control Manual*, National Institute for Occupational Safety and Health, Supt of Documents, U.S. Gov't Printing Office, Washington, DC 20402.
- V. Salmon (1975), "Practical Approaches to noise control in industry," *Noise-Con 75, Proceedings*, pp. 83-114.
- E. Sevin and W.D. Pilkey (1971), *Optimum Shock and Vibration Isolation*, Shock and Vibration Monograph Series, SVM-6, Navy Publications and Printing Service Office, Washington, D.C.
- S.J. Skaistis, D.E. Kennamer, and J.F. Walrad (1964), "Quieting of high-performance hydraulic systems," *20th Annual National Conference on Fluid Power*, Chicago, Oct 22, 1964, pp 51-60. "Noise in hydraulic systems," *Machine Design*, vol 36, Nov 19, 1964, pp 197-206.
- E. Skudrzyk (1959), "Theory of Noise and Vibration Isolation of a System with Many Resonances," *J Acoust Soc Am*, Vol 31, #1, Jan, pp 68-74.
- E. Skudrzyk (1968), *Simple and Complex Vibratory Systems*, Penn State Univ Press, University Park, Pennsylvania.
- J.C. Snowdon (1968), *Vibration and Shock in Damped Mechanical Systems*, John Wiley, New York.
- J.C. Snowdon and E.E. Ungar, eds (1973), *Isolation of Mechanical Vibration, Impact, and Noise*, ASME Colloquium Monograph AMD-1.
- D.B. Steinman (1956), "The Design of the Mackinac Bridge for Aerodynamic Stability," *J Franklin Inst*, Vol 262, #6, Dec, pp 453-468.
- J.W. Sullivan (1967), "Hydraulic Systems," *Machine Design*, Vol 39, #21, Sept 14, 1967, pp 210-215.
- C.K.W. Tam (1974), "Discrete tones of isolated airfoils," *J Acoust Soc Am*, Vol 55, #6, June 1974, pp 1173-1177.
- G.W. Van Santen (1953), *Mechanical Vibrations*, Philips Technical Library, Elsevier, Publishing Co., Amsterdam.
- VDI-2060 (October 1966), *Beurteilungsmass-stabe fur den Auswuchtzustand rotierender starrer Korper*, Verein Deutscher Ingenieure, Dusseldorf.
- I. Vigness (1965), "Vibration Isolation," *Physics Today*, Vol 18, #7, July, pp 42-48.
- J.B. Wilcox (1967), *Dynamic Balancing of Rotating Machinery*, Sir Isaac Pitman & Sons Ltd., London.
- W.K. Wilson (1959), *Vibration Engineering*, Charles Griffin, London.
- L.S. Wirt (1962), "An Amplitude Modulation Theory for Gear-Induced Vibrations," Chapter 17 in P.K. Stein (1962), *Measurement Engineering*, Stein Engineering Services, Tempe, Arizona.
- A. Wood and J.M. Bowsher (1975), *The Physics of Music*, Chapman and Hall, London, 7th edition.
- L.F. Yerges (1978), *Sound, Noise, and Vibration Control*, second edition, Van Nostrand Reinhold Company, New York.
- T.P. Yin (1969), "The Control of Vibration and Noise," *Scientific Amer*, Vol 220, #1, Jan, pp 98-107.
- T.P. Yin, T.J. Kelly and J.E. Barry (1967), "A Quantitative Evaluation of Constrained Layer Damping," *J of Engineering for Indus*, Trans ASME, Vol 89, Series B, #4, Nov, pp 773-784.

Chapter 17

Case Histories

Examples of noise problems and their solutions have been presented in many publications. Trade journals occasionally publish examples specific to their trade, and some of these are listed in the references to this chapter. The journals that are devoted to noise and vibration control, such as *Noise Control Engineering*, *SJV sound and vibration*, *Applied Acoustics*, and *Noise Control and Vibration Isolation* are good sources for examples. Technical conference proceedings of the Institute of Noise Control Engineering, Noisexpo, and many specialized conferences of ASME, IES, SAE, and universities are further sources. The *Industrial Noise Manual* of the American Industrial Hygiene Association and the *Foundry Noise Manual* of the American Foundryman's Society have numerous examples of noise control methods.

A number of government publications provide examples of noise control. The US National Institute for Occupational Safety and Health (NIOSH) has instituted a program to develop a collection of case histories in noise control. One of the results of this program is their "Industrial Noise Control Manual" by V. Salmon, J.S. Mills, and A.C. Petersen, NIOSH, Cincinnati, Ohio 45202, June 1975, Supt of Documents, Stock #1733-00073. The 30 case histories in the manual include a variety of examples of control by modification of the source or the path or both. A list of these examples with the general method of control is given in Table 17-1. A revised edition of this manual is now available. It adds 30 more case histories, and it was prepared by P. Jensen, C.R. Jokel, and L.N. Miller.

Table 17-1 Examples of Machinery Noise Control

| <i>Machine</i> | <i>Path</i> | <i>Source</i> | <i>Description of control technique</i> |
|------------------------------|-------------|---------------|---|
| Steel Wire Fabric Machine | ✓ | ✓ | Overhaul, change drive, cover holes |
| Blanking Press | ✓ | | Vibration Isolation |
| Blood Plasma Centrifuge | | ✓ | Muffler |
| Blanking Press Ram | | ✓ | Plugged slots |
| Spinning Frame Air Noise | | ✓ | Reduced air velocity |
| Barley Mill | ✓ | | Partial enclosure |
| Sheeter for Boxboard | ✓ | | Absorbent lining and acoustic trap |
| Air Scrap Handling | | ✓ | Damping of sheet metal |
| Jordans for Paper Mill | | ✓ | Lagging — fiberglass & lead |
| Air Hammer | ✓ | | Barrier wall |
| Printing and Cutting Press | ✓ | | Barrier wall |
| Air Scrap Handling Ducts | | ✓ | Lagging |
| Paper Machine, Wet End | ✓ | | Operator enclosure |
| Punch Press | ✓ | ✓ | Barrier, Reduced air velocity |
| Straight and Cut Machines | ✓ | | Barrier |
| Cut Punch Press | ✓ | | Barrier, Enclosure |
| Parts Conveying Chute | | ✓ | Constrained layer damping |
| Nail Making Machine | ✓ | | Vibration isolation |
| Wood Planer | | ✓ | Helical knife cutter |
| Punch Press | ✓ | ✓ | Various |
| Materials Handling—Air Motor | | ✓ | Muffler |
| Textile Braiding Machine | | ✓ | Plastic carriers |
| Metal Cut-off Saw | ✓ | | Enclosure |
| Wood Planer | ✓ | | Enclosure |
| Punch Press | ✓ | | Enclosure |
| Dewatering Vacuum Pump | | ✓ | Muffler and snubber |
| Steam Line Regulator | | ✓ | Throttling vanes |
| Plastics Scrap Grinder | | ✓ | Damping material on panels |
| Newspaper Printing Press | ✓ | | Enclosures, sealing and isolation, absorption |
| Chemical Process Plants | ✓ | ✓ | Wide variety |

REFERENCES

- American Foundrymen's Society (1972), *Control of Noise*, third edition, American Foundrymen's Society, Des Plaines, Ill.
- American Industrial Hygiene Association (1975), *Industrial Noise Manual*, third edition, AIHA, 66 S. Miller Road, Akron, OH 44313.
- American Petroleum Institute (1973), *Guidelines to Noise*, Medical Research Report EA7301, API, Washington, D.C.
- A.E.W. Austen and T. Priede (1958), "Origins of Diesel Engine Noise," *Proceedings of the Symposium on Engine Noise and Noise Suppression*, London, Institution of Mechanical Engineers, Oct, pp 19-32.
- L.L. Beranek, ed (1971), *Noise and Vibration Control*, McGraw-Hill, New York.
- L.L. Beranek, ed (1960), *Noise Reduction*, McGraw-Hill, New York.
- R.D. Berendt, E.L.R. Corliss and M.S. Ojalvo (1976) *Quieting: A Practical Guide to Noise Control*, National Bureau of Standards Handbook 119, Supt of Doc, U.S. Gov't Printing Office, Washington, DC 20402.
- R.T. Buscarello (1968), "Practical Solutions for Vibration Problems," *Chem Eng*, Vol 75, Aug 12, pp 157-166.
- M.J. Crocker, ed (1974), *Reduction of Machinery Noise*, Purdue University, Lafayette, Indiana.
- G.M. Diehl (1973), *Machinery Acoustics*, Wiley Interscience, New York.
- M. Feinberg (1965), "New Methods Simplify Analysis of Vibration Isolation Systems," Part 1, *Mach Des*, Vol 37, #18, Aug 5, pp 142-149.
- E.C. Grover and N. Lalor (1973), "A Review of Low Noise Diesel Engine Design at I.S.V.R.," *J Sound and Vib*, Vol 28, #3, 8 June 1973, pp 403-431.
- C.M. Harris, ed (1979), *Handbook of Noise Control*, second edition, McGraw-Hill, N.Y.
- C.M. Harris, ed (1957), *Handbook of Noise Control*, McGraw-Hill, New York.
- C.M. Harris and C.E. Crede (1976), *Shock and Vibration Handbook*, second edition, McGraw-Hill, New York.
- R.R. Hudson and M.J. Crocker (1970), "The Practical Problems Associated with Quieting a Refrigerant Compressor," *Applied Acoustics*, Vol 3, #4, Oct, pp 251-258.
- P. Jensen, C.R. Jokel, and L.N. Miller (1978), *Industrial Noise Control Manual*, Revised edition, US Dept of HEW, NIOSH, Cincinnati, Ohio, US Govt Printing Office, Washington, DC 20402.
- S.H. Judd (1969), "Engineering Control of Furnace Noise," *Amer Indust Hyg Assoc J*, Vol 30, #1, Jan-Feb, pp 35-40.
- S.H. Judd and J.A. Spence (1969), "Noise Control for Electric Motors," *Amer Indust Hyg Assoc J*, Vol 30, #6, Nov-Dec, pp 588-595.
- L.N. Miller and I. Dyer (1958), "Printing Machine Isolation," *Noise Control*, Vol 4, #4, July, pp 21-23.
- R.O. Mills (1969), "Noise Reduction in a Textile Weaving Mill," *Amer Indust Hyg Assoc J*, Vol 30, #1, Jan-Feb, pp 71-76.
- A.A. Putnam (1971), *Combustion Driven Oscillations in Industry*, American Elsevier, New York.
- G.E. Roe (1974), "The Silencing of a High Performance Motorcycle," *J Sound and Vib*, Vol 33, #1, 8 March 1974, pp 29-39.
- V. Salmon, J.S. Mills, and A.C. Petersen (1975), *Industrial Noise Control Manual*, US Dept of HEW, NIOSH, Cincinnati, OH 45202. (see P. Jensen et al)
- A. Thumann and R.K. Miller (1976), *Secrets of Noise Control*, 2nd edition, Fairmont Press, Atlanta, Georgia.
- P.J. Torpey (1969), "Noise Control of Emergency Power Generating Equipment," *Amer Indust Hyg Assoc J*, Vol 30, #6, Nov-Dec 1969, pp 588-595.
- US Bureau of Mines (1975), *Noise Control. Proceedings: Bureau of Mines Technology Transfer Seminar*, Pittsburgh, Pa., January 22, 1952, US Bureau of Mines, Washington, D.C.
- L.F. Yerges (1973), "Guidelines for Noise and Vibration Control," *Sound and Vibration*, August 1973, pp 18-21.

Appendix I

Decibel Conversion Tables

It is convenient in measurements and calculations to use a unit for expressing a logarithmic function of electric or acoustic power ratios. The *decibel* (1/10th of the bel) on the briggsian or base-10 scale is in almost universal use for this purpose.

Table I and Table II on the following pages have been prepared to facilitate making conversions in either direction between the number of decibels and the corresponding power and pressure ratios.

Decibel — The number of decibels N_{dB} corresponding to the ratio between two amounts of power W_1 and W_2 is

$$N_{dB} = 10 \log_{10} \frac{W_1}{W_2} \quad (1)$$

When two pressures P_1 and P_2 operate in the same or equal impedances.

$$N_{dB} = 20 \log_{10} \frac{P_1}{P_2} \quad (2)$$

To Find Values Outside The Range of Tables

Values outside the range of either Table I or Table II on the following pages can be readily found with the help of the following simple rules:

Table I: Decibels to Pressure and Power Ratios

Number of decibels positive (+): Subtract +20 decibels successively from the given number of decibels until the remainder falls within range of Table I. *To find the pressure ratio,* multiply the corresponding value from the right-hand voltage-ratio column by 10 for each time you subtracted 20 dB. To find the power ratio, multiply the corresponding value from the right-hand power-ratio column by 100 for each time you subtracted 20 dB.

Example — Given: 49.2 dB

$$49.2 \text{ dB} - 20 \text{ dB} - 20 \text{ dB} = 9.2 \text{ dB}$$

Pressure ratio: 9.2 dB —

$$2.884 \times 10 \times 10 = 288.4$$

Power ratio: 9.2 dB —

$$8.318 \times 100 \times 100 = 83180$$

Number of decibels negative (-): Add +20 decibels successively to the given number of decibels until the sum falls within the range of Table I. For the pressure ratio, divide the value from the left-hand pressure-ratio column by 10 for each time you added 20 dB. For the power ratio, divide the value from the left-hand power-ratio column by 100 for each time you added 20 dB.

Example — Given: -49.2 dB
 -49.2 dB + 20 dB + 20 dB = -9.2 dB
 Pressure ratio: -9.2 dB —
 $.3467 \times 1/10 \times 1/10 = .003467$
 Power ratio: -9.2 dB —
 $.1202 \times 1/100 \times 1/100 = .00001202$

Table II: Pressure Ratios to Decibels

For ratios smaller than those in table — Multiply the given ratio by 10 successively until the product can be found in the table. From the number of decibels thus found, subtract +20 decibels for each time you multiplied by 10.

Example — Given: Pressure ratio = .0131
 $.0131 \times 10 \times 10 = 1.31$
 From Table 11, 1.31 —
 2.34 dB — 20 dB — 20 dB = -37.66 dB

For ratios greater than those in table — Divide the given ratio by 10 successively until the remainder can be found in the table. To the number of decibels thus found, add +20 dB for each time you divided by 10.

Example — Given: Pressure ratio = 712
 $712 \times 1/10 \times 1/10 = 7.12$
 From Table II, 7.12 —
 17.05 dB + 20 dB + 20 dB = 57.05 dB

TABLE I

GIVEN: Decibels

TO FIND: Power and Pressure Ratios

TO ACCOUNT FOR THE SIGN OF THE DECIBEL

For positive (+) values of the decibel — Both pressure and power ratios are greater than unity. Use the two right-hand columns.

For negative (−) values of the decibel — Both pressure and power ratios are less than unity. Use the two left-hand columns.

Example—Given: ± 9.1 dB. Find:

| | | |
|---------|-------------|----------------|
| | Power Ratio | Pressure Ratio |
| +9.1 dB | 8.128 | 2.851 |
| −9.1 dB | 0.1230 | 0.3508 |

| ← -dB+ → | | | | | ← -dB+ → | | | | |
|----------------|-------------|-----|----------------|-------------|----------------|-------------|-----|----------------|-------------|
| Pressure Ratio | Power Ratio | dB | Pressure Ratio | Power Ratio | Pressure Ratio | Power Ratio | dB | Pressure Ratio | Power Ratio |
| 1.0000 | 1.0000 | 0 | 1.000 | 1.000 | .5623 | .3162 | 5.0 | 1.778 | 3.162 |
| .9886 | .9772 | .1 | 1.012 | 1.023 | .5559 | .3090 | 5.1 | 1.799 | 3.236 |
| .9772 | .9550 | .2 | 1.023 | 1.047 | .5495 | .3020 | 5.2 | 1.820 | 3.311 |
| .9661 | .9333 | .3 | 1.035 | 1.072 | .5433 | .2951 | 5.3 | 1.841 | 3.388 |
| .9550 | .9120 | .4 | 1.047 | 1.096 | .5370 | .2884 | 5.4 | 1.862 | 3.467 |
| .9441 | .8913 | .5 | 1.059 | 1.122 | .5309 | .2818 | 5.5 | 1.884 | 3.548 |
| .9333 | .8710 | .6 | 1.072 | 1.148 | .5248 | .2754 | 5.6 | 1.905 | 3.631 |
| .9226 | .8511 | .7 | 1.084 | 1.175 | .5188 | .2692 | 5.7 | 1.928 | 3.715 |
| .9120 | .8318 | .8 | 1.096 | 1.202 | .5129 | .2630 | 5.8 | 1.950 | 3.802 |
| .9016 | .8128 | .9 | 1.109 | 1.230 | .5070 | .2570 | 5.9 | 1.972 | 3.890 |
| .8913 | .7943 | 1.0 | 1.122 | 1.259 | .5012 | .2512 | 6.0 | 1.995 | 3.981 |
| .8810 | .7762 | 1.1 | 1.135 | 1.288 | .4955 | .2455 | 6.1 | 2.018 | 4.074 |
| .8710 | .7586 | 1.2 | 1.148 | 1.318 | .4898 | .2399 | 6.2 | 2.042 | 4.169 |
| .8610 | .7413 | 1.3 | 1.161 | 1.349 | .4842 | .2344 | 6.3 | 2.065 | 4.266 |
| .8511 | .7244 | 1.4 | 1.175 | 1.380 | .4786 | .2291 | 6.4 | 2.089 | 4.365 |
| .8414 | .7079 | 1.5 | 1.189 | 1.413 | .4732 | .2239 | 6.5 | 2.113 | 4.467 |
| .8318 | .6918 | 1.6 | 1.202 | 1.445 | .4677 | .2188 | 6.6 | 2.138 | 4.571 |
| .8222 | .6761 | 1.7 | 1.216 | 1.479 | .4624 | .2138 | 6.7 | 2.163 | 4.677 |
| .8128 | .6607 | 1.8 | 1.230 | 1.514 | .4571 | .2089 | 6.8 | 2.188 | 4.786 |
| .8035 | .6457 | 1.9 | 1.245 | 1.549 | .4519 | .2042 | 6.9 | 2.213 | 4.898 |
| .7943 | .6310 | 2.0 | 1.259 | 1.585 | .4467 | .1995 | 7.0 | 2.239 | 5.012 |
| .7852 | .6166 | 2.1 | 1.274 | 1.622 | .4416 | .1950 | 7.1 | 2.265 | 5.129 |
| .7762 | .6026 | 2.2 | 1.288 | 1.660 | .4365 | .1905 | 7.2 | 2.291 | 5.248 |
| .7674 | .5888 | 2.3 | 1.303 | 1.698 | .4315 | .1862 | 7.3 | 2.317 | 5.370 |
| .7586 | .5754 | 2.4 | 1.318 | 1.738 | .4266 | .1820 | 7.4 | 2.344 | 5.495 |
| .7499 | .5623 | 2.5 | 1.334 | 1.778 | .4217 | .1778 | 7.5 | 2.371 | 5.623 |
| .7413 | .5495 | 2.6 | 1.349 | 1.820 | .4169 | .1738 | 7.6 | 2.399 | 5.754 |
| .7328 | .5370 | 2.7 | 1.365 | 1.862 | .4121 | .1698 | 7.7 | 2.427 | 5.888 |
| .7244 | .5248 | 2.8 | 1.380 | 1.905 | .4074 | .1660 | 7.8 | 2.455 | 6.026 |
| .7161 | .5129 | 2.9 | 1.396 | 1.950 | .4027 | .1622 | 7.9 | 2.483 | 6.166 |
| .7079 | .5012 | 3.0 | 1.413 | 1.995 | .3981 | .1585 | 8.0 | 2.512 | 6.310 |
| .6998 | .4898 | 3.1 | 1.429 | 2.042 | .3936 | .1549 | 8.1 | 2.541 | 6.457 |
| .6918 | .4786 | 3.2 | 1.445 | 2.089 | .3890 | .1514 | 8.2 | 2.570 | 6.607 |
| .6839 | .4677 | 3.3 | 1.462 | 2.138 | .3846 | .1479 | 8.3 | 2.600 | 6.761 |
| .6761 | .4571 | 3.4 | 1.479 | 2.188 | .3802 | .1445 | 8.4 | 2.630 | 6.918 |
| .6683 | .4467 | 3.5 | 1.496 | 2.239 | .3758 | .1413 | 8.5 | 2.661 | 7.079 |
| .6607 | .4365 | 3.6 | 1.514 | 2.291 | .3715 | .1380 | 8.6 | 2.692 | 7.244 |
| .6531 | .4266 | 3.7 | 1.531 | 2.344 | .3673 | .1349 | 8.7 | 2.723 | 7.413 |
| .6457 | .4169 | 3.8 | 1.549 | 2.399 | .3631 | .1318 | 8.8 | 2.754 | 7.586 |
| .6383 | .4074 | 3.9 | 1.567 | 2.455 | .3589 | .1288 | 8.9 | 2.786 | 7.762 |
| .6310 | .3981 | 4.0 | 1.585 | 2.512 | .3548 | .1259 | 9.0 | 2.818 | 7.943 |
| .6237 | .3890 | 4.1 | 1.603 | 2.570 | .3508 | .1230 | 9.1 | 2.851 | 8.128 |
| .6166 | .3802 | 4.2 | 1.622 | 2.630 | .3467 | .1202 | 9.2 | 2.884 | 8.318 |
| .6095 | .3715 | 4.3 | 1.641 | 2.692 | .3428 | .1175 | 9.3 | 2.917 | 8.511 |
| .6026 | .3631 | 4.4 | 1.660 | 2.754 | .3388 | .1148 | 9.4 | 2.951 | 8.710 |
| .5957 | .3548 | 4.5 | 1.679 | 2.818 | .3350 | .1122 | 9.5 | 2.985 | 8.913 |
| .5888 | .3467 | 4.6 | 1.698 | 2.884 | .3311 | .1096 | 9.6 | 3.020 | 9.120 |
| .5821 | .3388 | 4.7 | 1.718 | 2.951 | .3273 | .1072 | 9.7 | 3.055 | 9.333 |
| .5754 | .3311 | 4.8 | 1.738 | 3.020 | .3236 | .1047 | 9.8 | 3.090 | 9.550 |
| .5689 | .3236 | 4.9 | 1.758 | 3.090 | .3199 | .1023 | 9.9 | 3.126 | 9.772 |

TABLE I (continued)

| ← -dB+ → | | | | | ← -dB+ → | | | | |
|----------------|-------------|------|----------------|-------------|----------------|-------------|------|----------------|-------------|
| Pressure Ratio | Power Ratio | dB | Pressure Ratio | Power Ratio | Pressure Ratio | Power Ratio | dB | Pressure Ratio | Power Ratio |
| .3162 | .1000 | 10.0 | 3.162 | 10.000 | .1585 | .02512 | 16.0 | 6.310 | 39.81 |
| .3126 | .09772 | 10.1 | 3.199 | 10.23 | .1567 | .02455 | 16.1 | 6.383 | 40.74 |
| .3090 | .09550 | 10.2 | 3.236 | 10.47 | .1549 | .02399 | 16.2 | 6.457 | 41.69 |
| .3055 | .09333 | 10.3 | 3.273 | 10.72 | .1531 | .02344 | 16.3 | 6.531 | 42.66 |
| .3020 | .09120 | 10.4 | 3.311 | 10.96 | .1514 | .02291 | 16.4 | 6.607 | 43.65 |
| .2985 | .08913 | 10.5 | 3.350 | 11.22 | .1496 | .02239 | 16.5 | 6.683 | 44.67 |
| .2951 | .08710 | 10.6 | 3.388 | 11.48 | .1479 | .02188 | 16.6 | 6.761 | 45.71 |
| .2917 | .08511 | 10.7 | 3.428 | 11.75 | .1462 | .02138 | 16.7 | 6.839 | 46.77 |
| .2884 | .08318 | 10.8 | 3.467 | 12.02 | .1445 | .02089 | 16.8 | 6.918 | 47.86 |
| .2851 | .08128 | 10.9 | 3.508 | 12.30 | .1429 | .02042 | 16.9 | 6.998 | 48.98 |
| .2818 | .07943 | 11.0 | 3.548 | 12.59 | .1413 | .01995 | 17.0 | 7.079 | 50.12 |
| .2786 | .07762 | 11.1 | 3.589 | 12.88 | .1396 | .01950 | 17.1 | 7.161 | 51.29 |
| .2754 | .07586 | 11.2 | 3.631 | 13.18 | .1380 | .01905 | 17.2 | 7.244 | 52.48 |
| .2723 | .07413 | 11.3 | 3.673 | 13.49 | .1365 | .01862 | 17.3 | 7.328 | 53.70 |
| .2692 | .07244 | 11.4 | 3.715 | 13.80 | .1349 | .01820 | 17.4 | 7.413 | 54.95 |
| .2661 | .07079 | 11.5 | 3.758 | 14.13 | .1334 | .01778 | 17.5 | 7.499 | 56.23 |
| .2630 | .06918 | 11.6 | 3.802 | 14.45 | .1318 | .01738 | 17.6 | 7.586 | 57.54 |
| .2600 | .06761 | 11.7 | 3.846 | 14.79 | .1303 | .01698 | 17.7 | 7.674 | 58.88 |
| .2570 | .06607 | 11.8 | 3.890 | 15.14 | .1288 | .01660 | 17.8 | 7.762 | 60.26 |
| .2541 | .06457 | 11.9 | 3.936 | 15.49 | .1274 | .01622 | 17.9 | 7.852 | 61.66 |
| .2512 | .06310 | 12.0 | 3.981 | 15.85 | .1259 | .01585 | 18.0 | 7.943 | 63.10 |
| .2483 | .06166 | 12.1 | 4.027 | 16.22 | .1245 | .01549 | 18.1 | 8.035 | 64.57 |
| .2455 | .06026 | 12.2 | 4.074 | 16.60 | .1230 | .01514 | 18.2 | 8.128 | 66.07 |
| .2427 | .05888 | 12.3 | 4.121 | 16.98 | .1216 | .01479 | 18.3 | 8.222 | 67.61 |
| .2399 | .05754 | 12.4 | 4.169 | 17.38 | .1202 | .01445 | 18.4 | 8.318 | 69.18 |
| .2371 | .05623 | 12.5 | 4.217 | 17.78 | .1189 | .01413 | 18.5 | 8.414 | 70.79 |
| .2344 | .05495 | 12.6 | 4.266 | 18.20 | .1175 | .01380 | 18.6 | 8.511 | 72.44 |
| .2317 | .05370 | 12.7 | 4.315 | 18.62 | .1161 | .01349 | 18.7 | 8.610 | 74.13 |
| .2291 | .05248 | 12.8 | 4.365 | 19.05 | .1148 | .01318 | 18.8 | 8.710 | 75.86 |
| .2265 | .05129 | 12.9 | 4.416 | 19.50 | .1135 | .01288 | 18.9 | 8.811 | 77.62 |
| .2239 | .05012 | 13.0 | 4.467 | 19.95 | .1122 | .01259 | 19.0 | 8.913 | 79.43 |
| .2213 | .04898 | 13.1 | 4.519 | 20.42 | .1109 | .01230 | 19.1 | 9.016 | 81.28 |
| .2188 | .04786 | 13.2 | 4.571 | 20.89 | .1096 | .01202 | 19.2 | 9.120 | 83.18 |
| .2163 | .04677 | 13.3 | 4.624 | 21.38 | .1084 | .01175 | 19.3 | 9.226 | 85.11 |
| .2138 | .04571 | 13.4 | 4.677 | 21.88 | .1072 | .01148 | 19.4 | 9.333 | 87.10 |
| .2113 | .04467 | 13.5 | 4.732 | 22.39 | .1059 | .01122 | 19.5 | 9.441 | 89.13 |
| .2089 | .04365 | 13.6 | 4.786 | 22.91 | .1047 | .01096 | 19.6 | 9.550 | 91.20 |
| .2065 | .04266 | 13.7 | 4.842 | 23.44 | .1035 | .01072 | 19.7 | 9.661 | 93.33 |
| .2042 | .04169 | 13.8 | 4.898 | 23.99 | .1023 | .01047 | 19.8 | 9.772 | 95.50 |
| .2018 | .04074 | 13.9 | 4.955 | 24.55 | .1012 | .01023 | 19.9 | 9.886 | 97.72 |
| .1995 | .03981 | 14.0 | 5.012 | 25.12 | .1000 | .01000 | 20.0 | 10.000 | 100.00 |
| .1972 | .03890 | 14.1 | 5.070 | 25.70 | | | | | |
| .1950 | .03802 | 14.2 | 5.129 | 26.30 | | | | | |
| .1928 | .03715 | 14.3 | 5.188 | 26.92 | | | | | |
| .1905 | .03631 | 14.4 | 5.248 | 27.54 | | | | | |
| .1884 | .03548 | 14.5 | 5.309 | 28.18 | | | | | |
| .1862 | .03467 | 14.6 | 5.370 | 28.84 | | | | | |
| .1841 | .03388 | 14.7 | 5.433 | 29.51 | | | | | |
| .1820 | .03311 | 14.8 | 5.495 | 30.20 | | | | | |
| .1799 | .03236 | 14.9 | 5.559 | 30.90 | | | | | |
| .1778 | .03162 | 15.0 | 5.623 | 31.62 | | | | | |
| .1758 | .03090 | 15.1 | 5.689 | 32.36 | | | | | |
| .1738 | .03020 | 15.2 | 5.754 | 33.11 | | | | | |
| .1718 | .02951 | 15.3 | 5.821 | 33.88 | | | | | |
| .1698 | .02884 | 15.4 | 5.888 | 34.67 | | | | | |
| .1679 | .02818 | 15.5 | 5.957 | 35.48 | | | | | |
| .1660 | .02754 | 15.6 | 6.026 | 36.31 | | | | | |
| .1641 | .02692 | 15.7 | 6.095 | 37.15 | | | | | |
| .1622 | .02630 | 15.8 | 6.166 | 38.02 | | | | | |
| .1603 | .02570 | 15.9 | 6.237 | 38.90 | | | | | |

| ← -dB+ → | | | | |
|--------------------------|------------------|-----|-------------------------|------------------|
| Pressure Ratio | Power Ratio | dB | Pressure Ratio | Power Ratio |
| 3.162 × 10 ⁻¹ | 10 ⁻¹ | 10 | 3.162 | 10 |
| | 10 ⁻¹ | 20 | 10 | 10 ² |
| 3.162 × 10 ⁻² | 10 ⁻² | 30 | 3.162 × 10 | 10 ³ |
| | 10 ⁻² | 40 | 10 ² | 10 ⁴ |
| 3.162 × 10 ⁻³ | 10 ⁻³ | 50 | 3.162 × 10 ³ | 10 ⁵ |
| | 10 ⁻³ | 60 | 10 ³ | 10 ⁶ |
| 3.162 × 10 ⁻⁴ | 10 ⁻⁴ | 70 | 3.162 × 10 ⁴ | 10 ⁷ |
| | 10 ⁻⁴ | 80 | 10 ⁴ | 10 ⁸ |
| 3.162 × 10 ⁻⁵ | 10 ⁻⁵ | 90 | 3.162 × 10 ⁵ | 10 ⁹ |
| | 10 ⁻⁵ | 100 | 10 ⁵ | 10 ¹⁰ |

TABLE II (continued)

| Pressure Ratio | .00 | .01 | .02 | .03 | .04 | .05 | .06 | .07 | .08 | .09 |
|----------------|--------|--------|--------|--------|--------|--------|--------|--------|--------|--------|
| 6.0 | 15.563 | 15.577 | 15.592 | 15.606 | 15.621 | 15.635 | 15.649 | 15.664 | 15.678 | 15.692 |
| 6.1 | 15.707 | 15.721 | 15.735 | 15.749 | 15.763 | 15.778 | 15.792 | 15.806 | 15.820 | 15.834 |
| 6.2 | 15.848 | 15.862 | 15.876 | 15.890 | 15.904 | 15.918 | 15.931 | 15.945 | 15.959 | 15.973 |
| 6.3 | 15.987 | 16.001 | 16.014 | 16.028 | 16.042 | 16.055 | 16.069 | 16.083 | 16.096 | 16.110 |
| 6.4 | 16.124 | 16.137 | 16.151 | 16.164 | 16.178 | 16.191 | 16.205 | 16.218 | 16.232 | 16.245 |
| 6.5 | 16.258 | 16.272 | 16.285 | 16.298 | 16.312 | 16.325 | 16.338 | 16.351 | 16.365 | 16.378 |
| 6.6 | 16.391 | 16.404 | 16.417 | 16.430 | 16.443 | 16.456 | 16.469 | 16.483 | 16.496 | 16.509 |
| 6.7 | 16.521 | 16.534 | 16.547 | 16.560 | 16.573 | 16.586 | 16.599 | 16.612 | 16.625 | 16.637 |
| 6.8 | 16.650 | 16.663 | 16.676 | 16.688 | 16.701 | 16.714 | 16.726 | 16.739 | 16.752 | 16.764 |
| 6.9 | 16.777 | 16.790 | 16.802 | 16.815 | 16.827 | 16.840 | 16.852 | 16.865 | 16.877 | 16.890 |
| 7.0 | 16.902 | 16.914 | 16.927 | 16.939 | 16.951 | 16.964 | 16.976 | 16.988 | 17.001 | 17.013 |
| 7.1 | 17.025 | 17.037 | 17.050 | 17.062 | 17.074 | 17.086 | 17.098 | 17.110 | 17.122 | 17.135 |
| 7.2 | 17.147 | 17.159 | 17.171 | 17.183 | 17.195 | 17.207 | 17.219 | 17.231 | 17.243 | 17.255 |
| 7.3 | 17.266 | 17.278 | 17.290 | 17.302 | 17.314 | 17.326 | 17.338 | 17.349 | 17.361 | 17.373 |
| 7.4 | 17.385 | 17.396 | 17.408 | 17.420 | 17.431 | 17.443 | 17.455 | 17.466 | 17.478 | 17.490 |
| 7.5 | 17.501 | 17.513 | 17.524 | 17.536 | 17.547 | 17.559 | 17.570 | 17.582 | 17.593 | 17.605 |
| 7.6 | 17.616 | 17.628 | 17.639 | 17.650 | 17.662 | 17.673 | 17.685 | 17.696 | 17.707 | 17.719 |
| 7.7 | 17.730 | 17.741 | 17.752 | 17.764 | 17.775 | 17.786 | 17.797 | 17.808 | 17.820 | 17.831 |
| 7.8 | 17.842 | 17.853 | 17.864 | 17.875 | 17.886 | 17.897 | 17.908 | 17.919 | 17.931 | 17.942 |
| 7.9 | 17.953 | 17.964 | 17.975 | 17.985 | 17.996 | 18.007 | 18.018 | 18.029 | 18.040 | 18.051 |
| 8.0 | 18.062 | 18.073 | 18.083 | 18.094 | 18.105 | 18.116 | 18.127 | 18.137 | 18.148 | 18.159 |
| 8.1 | 18.170 | 18.180 | 18.191 | 18.202 | 18.212 | 18.223 | 18.234 | 18.244 | 18.255 | 18.266 |
| 8.2 | 18.276 | 18.287 | 18.297 | 18.308 | 18.319 | 18.329 | 18.340 | 18.350 | 18.361 | 18.371 |
| 8.3 | 18.382 | 18.392 | 18.402 | 18.413 | 18.423 | 18.434 | 18.444 | 18.455 | 18.465 | 18.475 |
| 8.4 | 18.486 | 18.496 | 18.506 | 18.517 | 18.527 | 18.537 | 18.547 | 18.558 | 18.568 | 18.578 |
| 8.5 | 18.588 | 18.599 | 18.609 | 18.619 | 18.629 | 18.639 | 18.649 | 18.660 | 18.670 | 18.680 |
| 8.6 | 18.690 | 18.700 | 18.710 | 18.720 | 18.730 | 18.740 | 18.750 | 18.760 | 18.770 | 18.780 |
| 8.7 | 18.790 | 18.800 | 18.810 | 18.820 | 18.830 | 18.840 | 18.850 | 18.860 | 18.870 | 18.880 |
| 8.8 | 18.890 | 18.900 | 18.909 | 18.919 | 18.929 | 18.939 | 18.949 | 18.958 | 18.968 | 18.978 |
| 8.9 | 18.988 | 18.998 | 19.007 | 19.017 | 19.027 | 19.036 | 19.046 | 19.056 | 19.066 | 19.075 |
| 9.0 | 19.085 | 19.094 | 19.104 | 19.114 | 19.123 | 19.133 | 19.143 | 19.152 | 19.162 | 19.171 |
| 9.1 | 19.181 | 19.190 | 19.200 | 19.209 | 19.219 | 19.228 | 19.238 | 19.247 | 19.257 | 19.266 |
| 9.2 | 19.276 | 19.285 | 19.295 | 19.304 | 19.313 | 19.323 | 19.332 | 19.342 | 19.351 | 19.360 |
| 9.3 | 19.370 | 19.379 | 19.388 | 19.398 | 19.407 | 19.416 | 19.426 | 19.435 | 19.444 | 19.453 |
| 9.4 | 19.463 | 19.472 | 19.481 | 19.490 | 19.499 | 19.509 | 19.518 | 19.527 | 19.536 | 19.545 |
| 9.5 | 19.554 | 19.564 | 19.573 | 19.582 | 19.591 | 19.600 | 19.609 | 19.618 | 19.627 | 19.636 |
| 9.6 | 19.645 | 19.654 | 19.664 | 19.673 | 19.682 | 19.691 | 19.700 | 19.709 | 19.718 | 19.726 |
| 9.7 | 19.735 | 19.744 | 19.753 | 19.762 | 19.771 | 19.780 | 19.789 | 19.798 | 19.807 | 19.816 |
| 9.8 | 19.825 | 19.833 | 19.842 | 19.851 | 19.860 | 19.869 | 19.878 | 19.886 | 19.895 | 19.904 |
| 9.9 | 19.913 | 19.921 | 19.930 | 19.939 | 19.948 | 19.956 | 19.965 | 19.974 | 19.983 | 19.991 |

| Pressure Ratio | 0 | 1 | 2 | 3 | 4 | 5 | 6 | 7 | 8 | 9 |
|----------------|--------|--------|--------|--------|--------|--------|--------|--------|--------|--------|
| 10 | 20.000 | 20.828 | 21.584 | 22.279 | 22.923 | 23.522 | 24.082 | 24.609 | 25.105 | 25.575 |
| 20 | 26.021 | 26.444 | 26.848 | 27.235 | 27.604 | 27.959 | 28.299 | 28.627 | 28.943 | 29.248 |
| 30 | 29.542 | 29.827 | 30.103 | 30.370 | 30.630 | 30.881 | 31.126 | 31.364 | 31.596 | 31.821 |
| 40 | 32.041 | 32.256 | 32.465 | 32.669 | 32.869 | 33.064 | 33.255 | 33.442 | 33.625 | 33.804 |
| 50 | 33.979 | 34.151 | 34.320 | 34.486 | 34.648 | 34.807 | 34.964 | 35.117 | 35.269 | 35.417 |
| 60 | 35.563 | 35.707 | 35.848 | 35.987 | 36.124 | 36.258 | 36.391 | 36.521 | 36.650 | 36.777 |
| 70 | 36.902 | 37.025 | 37.147 | 37.266 | 37.385 | 37.501 | 37.616 | 37.730 | 37.842 | 37.953 |
| 80 | 38.062 | 38.170 | 38.276 | 38.382 | 38.486 | 38.588 | 38.690 | 38.790 | 38.890 | 38.988 |
| 90 | 39.085 | 39.181 | 39.276 | 39.370 | 39.463 | 39.554 | 39.645 | 39.735 | 39.825 | 39.913 |
| 100 | 40.000 | — | — | — | — | — | — | — | — | — |

TABLE II

GIVEN: { Pressure } Ratio

TO FIND: Decibels

POWER RATIOS

To find the number of decibels corresponding to a given power ratio—Assume the given power ratio to be a pressure ratio and find the corresponding number of decibels from the table. The desired result is exactly

one-half of the number of decibels thus found.

Example—Given: a power ratio of 3.41.
Find: 3.41 in the table:

$$3.41 \rightarrow 10.655 \text{ dB} \times \frac{1}{2} = 5.328 \text{ dB}$$

| Pressure Ratio | .00 | .01 | .02 | .03 | .04 | .05 | .06 | .07 | .08 | .09 |
|----------------|--------|--------|--------|--------|--------|--------|--------|--------|--------|--------|
| 1.0 | .000 | .086 | .172 | .257 | .341 | .424 | .506 | .588 | .668 | .749 |
| 1.1 | .828 | .906 | .984 | 1.062 | 1.138 | 1.214 | 1.289 | 1.364 | 1.438 | 1.511 |
| 1.2 | 1.584 | 1.658 | 1.727 | 1.798 | 1.868 | 1.938 | 2.007 | 2.076 | 2.144 | 2.212 |
| 1.3 | 2.279 | 2.345 | 2.411 | 2.477 | 2.542 | 2.607 | 2.671 | 2.734 | 2.798 | 2.860 |
| 1.4 | 2.923 | 2.984 | 3.046 | 3.107 | 3.167 | 3.227 | 3.287 | 3.346 | 3.405 | 3.464 |
| 1.5 | 3.522 | 3.580 | 3.637 | 3.694 | 3.750 | 3.807 | 3.862 | 3.918 | 3.973 | 4.028 |
| 1.6 | 4.082 | 4.137 | 4.190 | 4.244 | 4.297 | 4.350 | 4.402 | 4.454 | 4.506 | 4.558 |
| 1.7 | 4.609 | 4.660 | 4.711 | 4.761 | 4.811 | 4.861 | 4.910 | 4.959 | 5.008 | 5.057 |
| 1.8 | 5.105 | 5.154 | 5.201 | 5.249 | 5.296 | 5.343 | 5.390 | 5.437 | 5.483 | 5.529 |
| 1.9 | 5.575 | 5.621 | 5.666 | 5.711 | 5.756 | 5.801 | 5.845 | 5.889 | 5.933 | 5.977 |
| 2.0 | 6.021 | 6.064 | 6.107 | 6.150 | 6.193 | 6.235 | 6.277 | 6.319 | 6.361 | 6.403 |
| 2.1 | 6.444 | 6.486 | 6.527 | 6.568 | 6.608 | 6.649 | 6.689 | 6.729 | 6.769 | 6.809 |
| 2.2 | 6.848 | 6.888 | 6.927 | 6.966 | 7.006 | 7.044 | 7.082 | 7.121 | 7.159 | 7.197 |
| 2.3 | 7.235 | 7.272 | 7.310 | 7.347 | 7.384 | 7.421 | 7.458 | 7.495 | 7.532 | 7.568 |
| 2.4 | 7.604 | 7.640 | 7.676 | 7.712 | 7.748 | 7.783 | 7.819 | 7.854 | 7.889 | 7.924 |
| 2.5 | 7.959 | 7.993 | 8.028 | 8.062 | 8.097 | 8.131 | 8.165 | 8.199 | 8.232 | 8.266 |
| 2.6 | 8.299 | 8.333 | 8.366 | 8.399 | 8.432 | 8.465 | 8.498 | 8.530 | 8.563 | 8.595 |
| 2.7 | 8.627 | 8.659 | 8.691 | 8.723 | 8.755 | 8.787 | 8.818 | 8.850 | 8.881 | 8.912 |
| 2.8 | 8.943 | 8.974 | 9.005 | 9.036 | 9.066 | 9.097 | 9.127 | 9.158 | 9.188 | 9.218 |
| 2.9 | 9.248 | 9.278 | 9.308 | 9.337 | 9.367 | 9.396 | 9.426 | 9.455 | 9.484 | 9.513 |
| 3.0 | 9.542 | 9.571 | 9.600 | 9.629 | 9.657 | 9.686 | 9.714 | 9.743 | 9.771 | 9.799 |
| 3.1 | 9.827 | 9.855 | 9.883 | 9.911 | 9.939 | 9.966 | 9.994 | 10.021 | 10.049 | 10.076 |
| 3.2 | 10.103 | 10.130 | 10.157 | 10.184 | 10.211 | 10.238 | 10.264 | 10.291 | 10.317 | 10.344 |
| 3.3 | 10.370 | 10.397 | 10.423 | 10.449 | 10.475 | 10.501 | 10.527 | 10.553 | 10.578 | 10.604 |
| 3.4 | 10.630 | 10.655 | 10.681 | 10.706 | 10.731 | 10.756 | 10.782 | 10.807 | 10.832 | 10.857 |
| 3.5 | 10.881 | 10.906 | 10.931 | 10.955 | 10.980 | 11.005 | 11.029 | 11.053 | 11.078 | 11.102 |
| 3.6 | 11.126 | 11.150 | 11.174 | 11.198 | 11.222 | 11.246 | 11.270 | 11.293 | 11.317 | 11.341 |
| 3.7 | 11.364 | 11.387 | 11.411 | 11.434 | 11.457 | 11.481 | 11.504 | 11.527 | 11.550 | 11.573 |
| 3.8 | 11.596 | 11.618 | 11.641 | 11.664 | 11.687 | 11.709 | 11.732 | 11.754 | 11.777 | 11.799 |
| 3.9 | 11.821 | 11.844 | 11.866 | 11.888 | 11.910 | 11.932 | 11.954 | 11.976 | 11.998 | 12.019 |
| 4.0 | 12.041 | 12.063 | 12.085 | 12.106 | 12.128 | 12.149 | 12.171 | 12.192 | 12.213 | 12.234 |
| 4.1 | 12.256 | 12.277 | 12.298 | 12.319 | 12.340 | 12.361 | 12.382 | 12.403 | 12.424 | 12.444 |
| 4.2 | 12.465 | 12.486 | 12.506 | 12.527 | 12.547 | 12.568 | 12.588 | 12.609 | 12.629 | 12.649 |
| 4.3 | 12.669 | 12.690 | 12.710 | 12.730 | 12.750 | 12.770 | 12.790 | 12.810 | 12.829 | 12.849 |
| 4.4 | 12.869 | 12.889 | 12.908 | 12.928 | 12.948 | 12.967 | 12.987 | 13.006 | 13.026 | 13.045 |
| 4.5 | 13.064 | 13.084 | 13.103 | 13.122 | 13.141 | 13.160 | 13.179 | 13.198 | 13.217 | 13.236 |
| 4.6 | 13.255 | 13.274 | 13.293 | 13.312 | 13.330 | 13.349 | 13.368 | 13.386 | 13.405 | 13.423 |
| 4.7 | 13.442 | 13.460 | 13.479 | 13.497 | 13.516 | 13.534 | 13.552 | 13.570 | 13.589 | 13.607 |
| 4.8 | 13.625 | 13.643 | 13.661 | 13.679 | 13.697 | 13.715 | 13.733 | 13.751 | 13.768 | 13.786 |
| 4.9 | 13.804 | 13.822 | 13.839 | 13.857 | 13.875 | 13.892 | 13.910 | 13.927 | 13.945 | 13.962 |
| 5.0 | 13.979 | 13.997 | 14.014 | 14.031 | 14.049 | 14.066 | 14.083 | 14.100 | 14.117 | 14.134 |
| 5.1 | 14.151 | 14.168 | 14.185 | 14.202 | 14.219 | 14.236 | 14.253 | 14.270 | 14.287 | 14.303 |
| 5.2 | 14.320 | 14.337 | 14.353 | 14.370 | 14.387 | 14.403 | 14.420 | 14.436 | 14.453 | 14.469 |
| 5.3 | 14.486 | 14.502 | 14.518 | 14.535 | 14.551 | 14.567 | 14.583 | 14.599 | 14.616 | 14.632 |
| 5.4 | 14.648 | 14.664 | 14.680 | 14.696 | 14.712 | 14.728 | 14.744 | 14.760 | 14.776 | 14.791 |
| 5.5 | 14.807 | 14.823 | 14.839 | 14.855 | 14.870 | 14.886 | 14.902 | 14.917 | 14.933 | 14.948 |
| 5.6 | 14.964 | 14.979 | 14.995 | 15.010 | 15.026 | 15.041 | 15.056 | 15.072 | 15.087 | 15.102 |
| 5.7 | 15.117 | 15.133 | 15.148 | 15.163 | 15.178 | 15.193 | 15.208 | 15.224 | 15.239 | 15.254 |
| 5.8 | 15.269 | 15.284 | 15.298 | 15.313 | 15.328 | 15.343 | 15.358 | 15.373 | 15.388 | 15.402 |
| 5.9 | 15.417 | 15.432 | 15.446 | 15.461 | 15.476 | 15.490 | 15.505 | 15.519 | 15.534 | 15.549 |

Appendix II

Chart for Combining Levels of Uncorrelated Noise Signals*

TO ADD LEVELS

Enter the chart with the NUMERICAL DIFFERENCE BETWEEN TWO LEVELS BEING ADDED. Follow the line corresponding to this value to its intersection with the curved line, then left to read the NUMERICAL DIFFERENCE BETWEEN TOTAL AND LARGER LEVEL. Add this value to the larger level to determine the total.

Example: Combine 75 dB and 80 dB. The difference is 5 dB. The 5-dB line intersects the curved line at 1.2 dB on the vertical scale. Thus the total value is 80 + 1.2 or 81.2 dB.

TO SUBTRACT LEVELS

Enter the chart with the NUMERICAL DIFFERENCE BETWEEN TOTAL AND LARGER LEVELS if this value is less than 3 dB. Enter the chart with the NUMERICAL DIFFERENCE BETWEEN TOTAL AND SMALLER LEVELS if this value is between 3 and 14 dB. Follow the line corresponding to this value to its intersection with the curved line, then either left or down to read the NUMERICAL DIFFERENCE BETWEEN TOTAL AND LARGER (SMALLER) LEVELS. Subtract this value from the total level to determine the unknown level.

Example: Subtract 81 dB from 90 dB. The difference is 9 dB. The 9-dB vertical line intersects the curved line at 0.6 dB on the vertical scale. Thus the unknown level is 90 - 0.6 or 89.4 dB.

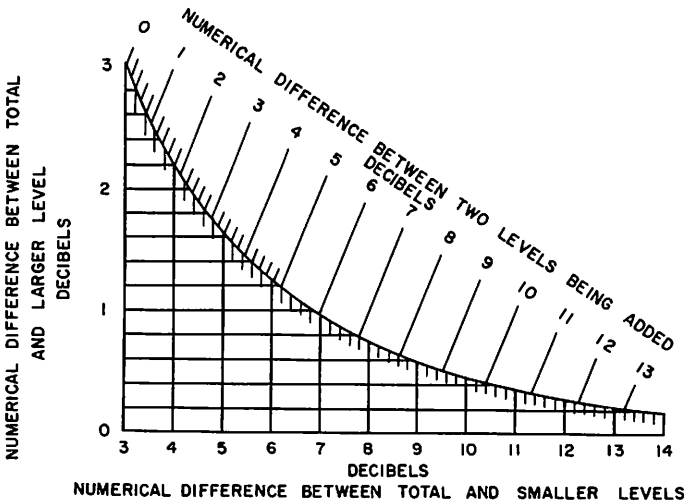

*This chart is based on one developed by R. Musa.

Appendix III

Table for Converting Loudness to Loudness Level

A simplified relation between the loudness in sones and the loudness level in phons has been standardized internationally (ISO/R131-1959). This relation is a good approximation to the psychoacoustical data and is useful for engineering purposes, but it should not be expected to be accurate enough for research on the subjective aspects of hearing.

The relation is

$$S = 2^{(P-40)/10}$$

where S is the loudness in sones and P is the loudness level in phons.

A table of loudness in sones for loudness levels ranging from 20 to 130 phons in increments of 1 phon, calculated from the above relation, is given below.

Examples:

Given — loudness level of 72 phons.

Find — in table under “+2” in the “70” row — 9.2 sones.

| Phons | LOUDNESS IN SONES | | | | | | | | | |
|-------|-------------------|------|------|------|------|------|------|------|------|------|
| | 0 | +1 | +2 | +3 | +4 | +5 | +6 | +7 | +8 | +9 |
| 20 | .25 | .27 | .29 | .31 | .33 | .35 | .38 | .41 | .44 | .47 |
| 30 | .50 | .54 | .57 | .62 | .66 | .71 | .76 | .81 | .87 | .93 |
| 40 | 1 | 1.07 | 1.15 | 1.23 | 1.32 | 1.41 | 1.52 | 1.62 | 1.74 | 1.87 |
| 50 | 2 | 2.14 | 2.30 | 2.46 | 2.64 | 2.83 | 3.03 | 3.25 | 3.48 | 3.73 |
| 60 | 4 | 4.29 | 4.59 | 4.92 | 5.28 | 5.66 | 6.06 | 6.50 | 6.96 | 7.46 |
| 70 | 8 | 8.6 | 9.2 | 9.8 | 10.6 | 11.3 | 12.1 | 13.0 | 13.9 | 14.9 |
| 80 | 16 | 17.1 | 18.4 | 19.7 | 21.1 | 22.6 | 24.3 | 26.0 | 27.9 | 29.9 |
| 90 | 32 | 34.3 | 36.8 | 39.4 | 42.2 | 45.3 | 48.5 | 52.0 | 55.7 | 59.7 |
| 100 | 64 | 68.6 | 73.5 | 78.8 | 84.4 | 90.5 | 97 | 104 | 111 | 119 |
| 110 | 128 | 137 | 147 | 158 | 169 | 181 | 194 | 208 | 223 | 239 |
| 120 | 256 | 274 | 294 | 315 | 338 | 362 | 388 | 416 | 446 | 478 |

Appendix IV

Vibration Conversion Charts

The charts on the following pages illustrate the relation among frequency, velocity, acceleration, and displacement (refer to Chapter 2).

Figures IV-1 and IV-2 are general conversion charts for frequency, displacement, velocity, and acceleration. Enter the chart with any two of these parameters to solve for the other two. In Figure IV-1, displacement, velocity, and acceleration are given in inches, inches/second, and inches/second², respectively, while Figure IV-2 uses metric units.

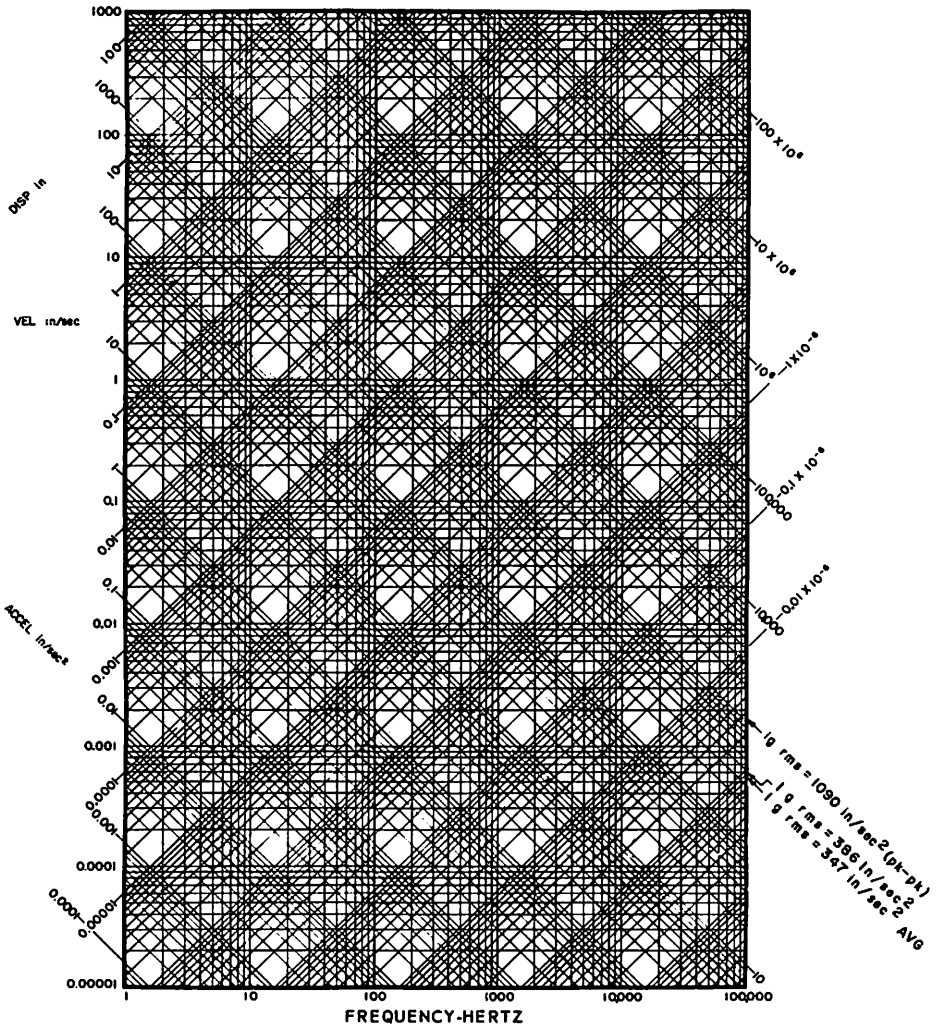
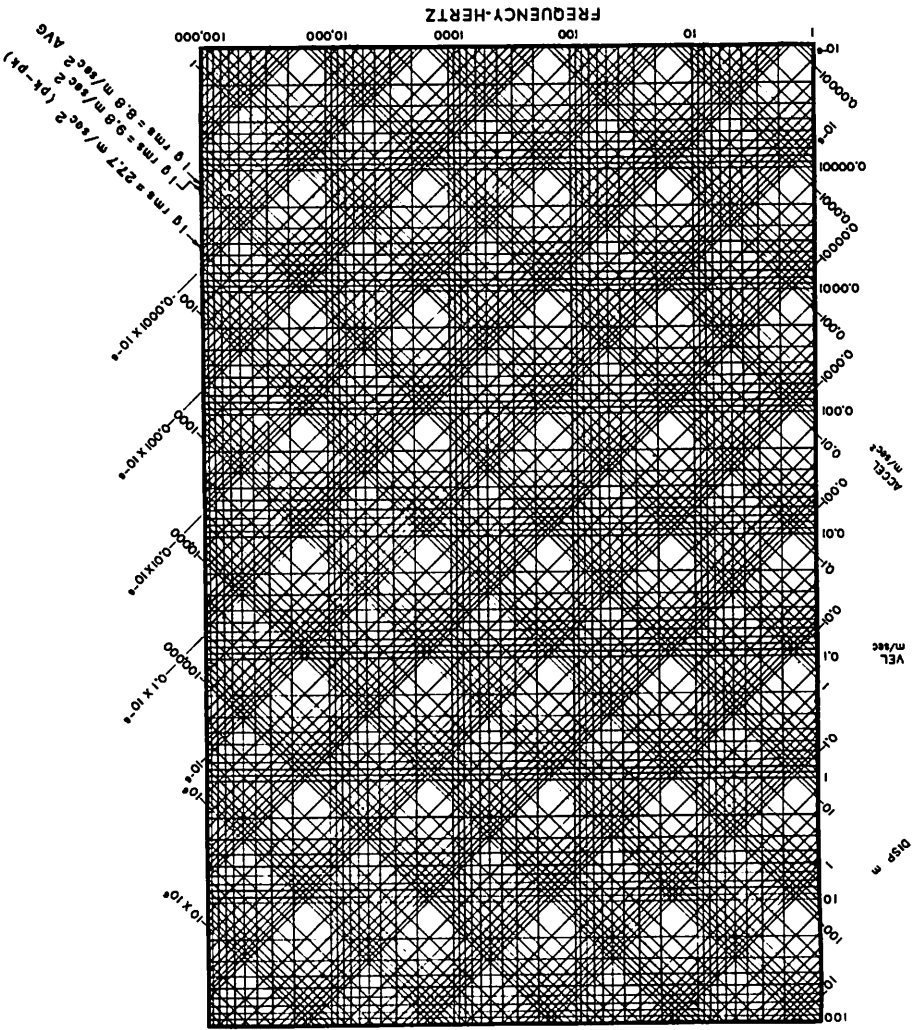

Figure IV-1. Conversion chart for vibration parameters.

Figure IV-2. Conversion chart for vibration parameters, metric units.



Appendix V

Definitions

This section on definitions includes most of the technical terms used in this handbook. Most of the definitions are selected from the American National Standard Acoustical Terminology (S1.1-1960 [R1971]), and those definitions are marked with an asterisk. They are printed with permission.

Many have been shortened by putting them in the usual dictionary form, and the name of the unit for pressure has been changed to "pascal," as specified in the International System of Units (SI). A number of these standard definitions are very technical in order to be precise. Some readers may find it easier to refer to the discussion in the main text of this handbook to obtain a general understanding of those terms.

The nonstandard definitions have been adapted especially for this handbook.

ACCELERATION*

vector that specifies the time-rate-of-change of velocity. Note 1: Various self-explanatory modifiers such as peak, average, rms are often used. The time interval must be indicated over which the average (for example) was taken. Note 2: Acceleration may be (1) oscillatory, in which case it may be defined by the acceleration amplitude (if simple harmonic) or the rms acceleration (if random), or (2) nonoscillatory, in which case it is designated "sustained" or "transient" acceleration.

ALIAS

in sampled, equally spaced data, two frequencies are aliases of one another if sinusoids of those frequencies cannot be distinguished by the sampled values.

AMBIENT NOISE*

the all-encompassing noise associated with a given environment, being usually a composite of sounds from many sources near and far.

AMPLITUDE DENSITY DISTRIBUTION (PROBABILITY DENSITY DISTRIBUTION)(FREQUENCY DISTRIBUTION)

a function giving the fraction of time that the pressure, voltage, or other variable dwells in a narrow range.

AMPLITUDE DISTRIBUTION FUNCTION (DISTRIBUTION FUNCTION) (PROBABILITY FUNCTION)(CUMULATIVE FREQUENCY FUNCTION)

a function giving the fraction of time that the instantaneous pressure, voltage or other variable lies below a given level.

ANALYZER

a combination of a filter system and a system for indicating the relative energy that is passed through the filter system. The filter is usually adjustable so that the signal applied to the filter can be measured in terms of the relative energy passed through the filter as a function of the adjustment of the filter response-vs-frequency characteristic. This measurement is usually interpreted as giving the distribution of energy of the applied signal as a function of frequency.

ANECHOIC ROOM (FREE-FIELD ROOM)*

a room whose boundaries absorb effectively all the sound incident thereon, thereby affording essentially free-field conditions.

AUDIOGRAM (THRESHOLD AUDIOGRAM)

a graph showing hearing-threshold level (HTL) as a function of frequency.

AUDIOMETER

an instrument for measuring hearing threshold level.

AUTOCORRELATION

a measure of the similarity of a function with a displaced version of itself as a function of the displacement. The displacement is usually in terms of time and, when the displacement is zero, the value of the autocorrelation is equal to the mean square value of the function.

AUTOSPECTRUM (POWER SPECTRUM)

a spectrum with the coefficients of the components expressed as the square of the magnitudes.

BACKGROUND NOISE*

the total of all sources of interference in a system used for the production, detection, measurement, or recording of a signal, independent of the presence of the signal.

Note 1: Ambient noise detected, measured, or recorded with the signal becomes part of the background noise.

Note 2: Included in this definition is the interference resulting from primary power supplies, that separately is commonly described as *hum*.

BAFFLE*

a shielding structure or partition used to increase the effective length of the external transmission path between two points in an acoustic system as, for example, between the front and back of an electroacoustic transducer.

BAND NUMBER (see STANDARD BAND NUMBER)**BEL***

a unit of level when the base of the logarithm is 10. Use of the bel is restricted to levels of quantities proportional to power.

COHERENCE

a measure of the reliability of a transfer function estimate. It is zero when the transfer function has no statistical validity and unity when the estimate is not contaminated by interfering noise.

CONFIDENCE LIMITS

the upper and lower values of the range over which a given percent probability applies. For instance, if the chances are 99 out of 100 that a sample lies between 10 and 12, the 99% confidence limits are said to be 10 and 12.

CREST FACTOR

the ratio of the instantaneous peak value of a wave to its root-mean-square value (rms).

CRITICAL SPEED*

a speed of a rotating system that corresponds to a resonance frequency of the system.

CROSSCORRELATION

a measure of the similarity of two functions with the displacement between the two used as an independent variable. The displacement is usually in terms of time. When the two functions are alike, a crosscorrelation is an autocorrelation.

CROSS-SPECTRUM

a measure in the frequency domain of the similarity of two functions.

DATA WINDOW

the interval that includes all the sampled values in a calculation, also the form of a weighting function that is regarded as multiplying the data that enters into a calculation.

DAY-NIGHT SOUND LEVEL (L_{dn})

the level of the mean-square A-weighted sound pressure during a 24-hour period with the mean-square pressure during the hours of 10 pm to 7 am (2200 to 0700 hours) multiplied by 10. The reference pressure squared is $(20\mu\text{Pa})^2$.

DEAD ROOM* (See also ANECHOIC ROOM)

a room that is characterized by an unusually large amount of sound absorption.

DECAY RATE (See RATE OF DECAY)**DECIBEL***

one-tenth of a bel. Thus, the decibel is a unit of level when the base of the logarithm is the tenth root of ten, and the quantities concerned are proportional to power. Note 1: Examples of quantities that qualify are power (any form), sound pressure squared, particle velocity squared, sound intensity, sound energy density, voltage squared. Thus the decibel is a unit of sound-pressure-squared level; it is common practice, however, to shorten this to sound pressure level because ordinarily no ambiguity results from so doing. Note 2: The logarithm to the base the tenth root of 10 is the same as ten times the logarithm to the base 10: e.g., for a number x^2 , $\log_{10^{0.1}}x^2 = 10 \log_{10}x^2 = 20 \log_{10}x$. This last relationship is the one ordinarily used to simplify the language in definitions of sound pressure level, etc.

DEGREES OF FREEDOM (STATISTICAL)

a measure of stability relating to the number of independent equivalent terms entering into a distribution.

DIRECTIVITY FACTOR*

1. of a transducer used for sound emission is the ratio of the sound pressure squared, at some fixed distance and specified direction, to the mean-square sound pressure at the same distance averaged over all directions from the transducer. The distance must be great enough so that the sound appears to diverge spherically from the effective acoustic center of the sources. Unless otherwise specified, the reference direction is understood to be that of maximum response.

2. of a transducer used for sound reception is the ratio of the square of the open-circuit voltage produced in response to sound waves arriving in a specified direction to the mean-square voltage that would be produced in a perfectly diffused sound field of the same frequency and mean-square sound pressure.

Note 1: This definition may be extended to cover the case of finite frequency bands whose spectrum may be specified. Note 2: The average free-field response may be obtained, for example,

1. By the use of a spherical integrator
2. By numerical integration of a sufficient number of directivity patterns corresponding to different planes, or
3. By integration of one or two directional patterns whenever the pattern of the transducer is known to possess adequate symmetry.

DIRECTIONAL GAIN (DIRECTIVITY INDEX)*

of a transducer, in decibels, is 10 times the logarithm to the base 10 of the directivity factor.

DISPLACEMENT*

a vector quantity that specifies the change of position of a body or particle and is usually measured from the mean position or position of rest. In general, it can be represented by a rotation vector or translation vector or both.

DISTRIBUTION (See AMPLITUDE DISTRIBUTION FUNCTION)

EARPHONE (RECEIVER)*

an electroacoustic transducer intended to be closely coupled acoustically to the ear. Note: the term "receiver" should be avoided when there is risk of ambiguity.

EFFECTIVE SOUND-PRESSURE (ROOT-MEAN-SQUARE SOUND PRESSURE)*

at a point is the root-mean-square value of the instantaneous sound pressures, over a time interval at the point under consideration. In the case of periodic sound pressures, the interval must be an integral number of periods or an interval long compared to a period. In the case of non-periodic sound pressures, the interval should be long enough to make the value obtained essentially independent of small changes in the length of the interval. Note: The term "effective sound pressure" is frequently shortened to "sound pressure."

ENSEMBLE AVERAGE (See TIME AVERAGE)

the average of a number of samples of equivalent processes at a given time. This definition is much simplified, but it is intended to show a distinction between ensemble averaging and averaging over time. This distinction is rarely maintained except in theoretical discussion of random processes.

EQUIVALENT SOUND LEVEL (L_{eq})

the level of the mean-square A-weighted sound pressure over a given time interval. The time should be given in hours or else the unit must be specified. If a weighting different from A-weighting is used, it must be specified. The reference pressure squared is $(20\mu\text{Pa})^2$.

FFT (FAST-FOURIER TRANSFORM)

any of a number of calculation procedures that yields a set of Fourier coefficients (component amplitudes) from a time-series frame with much less computational effort for large frame sizes than is possible by the classical approach of successive calculation of each coefficient.

FILTER

a device for separating components of a signal on the basis of their frequency. It allows components in one or more frequency bands to pass relatively unattenuated, and it attenuates components in other frequency bands.

FOLDING FREQUENCY

reciprocal of twice the time interval between sampled values. The folding frequency is equal to its own alias.

FRAME

a set of points or values that are processed as a group.

FRAME SIZE

the number of sampled values in a frame.

FREE SOUND FIELD (FREE FIELD)*

a field in a homogeneous, isotropic medium, free from boundaries. In practice, it is a field in which the effects of the boundaries are negligible over the region of interest. Note: The actual pressure impinging on an object (e.g., electro-acoustic transducer) placed in an otherwise free sound field will differ from the pressure that would exist at that point with the object removed, unless the acoustic impedance of the object matches the acoustic impedance of the medium.

FREQUENCY (IN CYCLES PER SECOND OR HERTZ)

the time rate of repetition of a periodic phenomenon. The frequency is the reciprocal of the period.

FREQUENCY DISTRIBUTION (STATISTICAL) (See AMPLITUDE DENSITY DISTRIBUTION)**g***

quantity that is the acceleration produced by the force of gravity, which varies with the latitude and elevation of the point of observation. By international agreement, the value $980.665 \text{ cm/s}^2 = 386.087 \text{ in./s}^2 = 32.1739 \text{ ft/s}^2$ has been chosen as the standard acceleration of gravity.

GAUSSIAN DISTRIBUTION (NORMAL DISTRIBUTION)

a particular amplitude distribution of fundamental importance in the theory of probability. Its histogram is the familiar "bell-shaped curve." It describes many natural phenomena, and most stationary acoustic noise that is not periodic has an essentially Gaussian distribution.

HANNING

use of a smooth data window that has the form in the time domain of a raised cosine arch. The weighting is zero at the beginning and end of a frame and unity in the middle of the frame. (After Julius von Hann, an Austrian meteorologist.)

HEARING THRESHOLD LEVEL (OF AN EAR)***

amount in decibels by which the threshold of audibility for that ear exceeds a standard audiometric threshold.

HISTOGRAM

graph of an amplitude density distribution.

IMPACT*

a single collision of one mass in motion with a second mass which may be either in motion or at rest.

ISOLATION*

a reduction in the capacity of a system to respond to an excitation attained by the use of a resilient support. In steady-state forced vibration, isolation is expressed quantitatively as the complement of transmissibility.

JERK*

a vector that specifies the time rate of change of the acceleration; jerk is the third derivative of the displacement with respect to time.

L_{dn}

See DAY-NIGHT SOUND LEVEL

L_{eq}

See EQUIVALENT SOUND LEVEL

LEVEL*

in acoustics, the level of a quantity is the logarithm of the ratio of that quantity to a reference quantity of the same kind. The base of the logarithm, the reference quantity, and the *kind* of level must be specified. Note 1: Examples of kinds of levels in common use are electric power level, sound-pressure-squared level, voltage-squared level. Note 2: The level as here defined is measured in units of the logarithm of a reference ratio that is equal to the base of logarithms. Note 3: In symbols

$$L = \log_r(q/q_0)$$

where L = level of kind determined by the kind of quantity under consideration, measured in units of log_r

r = base of logarithms and the reference ratio

q = the quantity under consideration

q₀ = reference quantity of the same kind.

Note 4: Differences in the levels of two quantities q₁ and q₂ are described by the same formula because, by the rules of logarithms, the reference quantity is automatically divided out:

$$\log_r(q_1/q_0) - \log_r(q_2/q_0) = \log_r(q_1/q_2)$$

LEVEL DISTRIBUTION

set of numbers characterizing a noise exposure, which gives the length of time that the sound-pressure level dwelled within each of a set of level intervals.

LINE COMPONENT

simple tone that may be part of a complex signal.

LIVE ROOM*

a room that is characterized by an unusually small amount of sound absorption.

LOUDNESS*

the intensive attribute of an auditory sensation, in terms of which sounds may be ordered on a scale extending from soft to loud. Note: Loudness depends primarily upon the sound pressure of the stimulus, but it also depends upon the frequency and wave form of the stimulus.

LOUDNESS CONTOUR*

a curve that shows the related values of sound pressure levels and frequency required to produce a given loudness sensation for the typical listener.

LOUDNESS LEVEL*

of a sound, in phons, is numerically equal to the median sound pressure level, in decibels, relative to 0.0002 microbar, of a free progressive wave of frequency 1000 Hz presented to listeners facing the source, which in a number of trials is judged by the listeners to be equally loud. Note: The manner of listening to the unknown sound, which must be stated, may be considered one of the characteristics of that sound.

LOUDSPEAKER (SPEAKER)*

an electroacoustic transducer intended to radiate acoustic power into the air, the acoustic waveform being essentially equivalent to that of the electrical input.

MASKING*

1. the process by which the threshold of audibility for one sound is raised by the presence of another (masking) sound.
2. the amount by which the threshold of audibility of a sound is raised by the presence of another (masking) sound. The unit customarily used is the decibel.

MECHANICAL IMPEDANCE*

the impedance obtained from the ratio of force to velocity during simple harmonic motion.

MECHANICAL SHOCK*

occurs when the position of a system is significantly changed in a relatively short time in a nonperiodic manner. It is characterized by suddenness and large displacement, and develops significant inertial forces in the system.

MEL*

a unit of pitch. By definition, a simple tone of frequency 1000 Hz, 40 decibels above a listener's threshold, produces a pitch of 1000 mels. The pitch of any sound that is judged by the listener to be n times that of a 1-mel tone is n mels.

MICROBAR, DYNE PER SQUARE CENTIMETER* (See Pascal)

a unit of pressure commonly used in acoustics. One microbar is equal to 1 dyne per square centimeter. Note: The term "bar" properly denotes a pressure of 10^6 dynes per square centimeter. Unfortunately, the bar was once used to mean 1 dyne per square centimeter, but this is no longer correct. [Note: This unit has been superseded by "pascal."]

MICROPHONE*

an electroacoustic transducer that responds to sound waves and delivers essentially equivalent electric waves.

NEWTON

the unit of force in the International System of Units.

NNI

the noise and number index based on perceived noise level. It is used for rating airplane flyby noise.

NOISE*

1. any undesired sound. By extension, noise is any unwanted disturbance within a useful frequency band, such as undesired electric waves in a transmission channel or device.
2. an erratic, intermittent, or statistically random oscillation.

Note 1: If ambiguity exists as to the nature of the noise, a phrase such as "acoustic noise" or "electric noise" should be used. Note 2: Since the above definitions are not mutually exclusive, it is usually necessary to depend upon context for the distinction.

NOISE LEVEL*

1. the level of noise, the type of which must be indicated by further modifier or context.

Note: The physical quantity measured (e.g. voltage), the reference quantity, the instrument used, and the bandwidth or other weighting characteristic must be indicated.

2. For airborne sound unless specified to the contrary, noise level is the weighted sound pressure level called sound level; the weighting must be indicated.

NORMAL DISTRIBUTION

See GAUSSIAN DISTRIBUTION.

NOYS

a unit used in the calculation of perceived noise level.

NYQUIST INTERVAL

period equal to the reciprocal of twice the frequency of that component of the signal having the highest frequency. It is the maximum sampling-time interval that permits reconstruction of a band-limited signal.

OCTAVE*

1. the interval between two sounds having a basic frequency ratio of two.
2. the pitch interval between two tones such that one tone may be regarded as duplicating the basic musical import of the other tone at the nearest possible higher pitch.

Note 1: The interval, in octaves, between any two frequencies is the logarithm to the base 2 (or 3.322 times the logarithm to the base 10) of the frequency ratio.

Note 2: The frequency ratio corresponding to an octave pitch interval is approximately, but not always exactly, 2:1.

ONE-THIRD OCTAVE (THIRD OCTAVE)

the interval between two tones having a basic frequency ratio of the cube root of two. ($f_2/f_1 = \sqrt[3]{2} \approx 1.25992$)

OSCILLATION*

the variation, usually with time, of the magnitude of a quantity with respect to a specified reference when the magnitude is alternately greater and smaller than the reference.

PASCAL

a unit of pressure commonly used in acoustics. One pascal is equal to one newton per square meter.

PEAK-TO-PEAK VALUE*

of an oscillating quantity is the algebraic difference between the extremes of the quantity.

PERCEIVED NOISE LEVEL

the level in dB assigned to a noise by means of a calculation procedure that is based on an approximation to subjective evaluations of "noisiness."

PERIODIC QUANTITY*

oscillating quantity whose values recur for certain increments of the independent variable.

PHON*

unit of loudness level. (See **LOUDNESS LEVEL**.)

PINK NOISE

noise whose noise-power-per-unit-frequency interval is inversely proportional to frequency over a specified range.

PITCH*

that attribute of auditory sensation in terms of which sounds may be ordered on a scale extending from low to high. Pitch depends primarily upon the frequency of the sound stimulus, but it also depends upon the sound pressure and wave form of the stimulus. Note 1: The pitch of a sound may be described by the frequency or frequency level of that simple tone, having a specified sound pressure level, which is judged by listeners to produce the same pitch.

POINT SOURCE See "SIMPLE SOUND SOURCE."

POWER LEVEL

in decibels, is 10 times the logarithm to the base 10 of the ratio of a given power to a reference power. The reference power must be indicated. [The reference power is taken as 1.0×10^{-12} watt in this handbook.]

PRESBYCUSIS

the condition of hearing loss specifically ascribed to aging effects.

PRESSURE SPECTRUM LEVEL

of a sound at a particular frequency is the effective sound-pressure level of that part of the signal contained within a band 1 hertz wide, centered at the particular frequency. Ordinarily this has significance only for sound having a continuous distribution of energy within the frequency range under consideration. The reference pressure should be explicitly stated.

PRIMITIVE PERIOD (PERIOD)*

of a periodic quantity is the smallest increment of the independent variable for which the function repeats itself. Note: If no ambiguity is likely, the primitive period is simply called the period of the function.

PROBABILITY DENSITY DISTRIBUTION

See **AMPLITUDE DENSITY DISTRIBUTION**.

PSIL (THREE-BAND PREFERRED-OCTAVE SPEECH-INTERFERENCE LEVEL)(SPEECH INTERFERENCE LEVEL)

average, in dB, of the sound-pressure levels of a noise in the three octave bands of center frequency 500, 1000, and 2000 Hz. The speech interference level, or SIL, without the qualifying "PREFERRED" is usually the arithmetic average of the sound-pressure levels in the older series of three octave bands: 600 to 1200, 1200 to 2400, and 2400 to 4800 Hz.

PURE TONE See **SIMPLE TONE**.

QUANTIZATION

conversion of a value into one of a limited set of values. The limited set is usually a discrete series of total number equal to two raised to an integer power, that is, a binary set.

RANDOM NOISE*

an oscillation whose instantaneous magnitude is not specified for any given instant of time. The instantaneous magnitudes of a random noise are specified only by probability distribution functions giving the fraction of the total time that the magnitude, or some sequence of magnitudes, lies within a specified range. Note: A random noise whose instantaneous magnitudes occur according to Gaussian distribution is called Gaussian random noise.

RATE OF DECAY*

the time rate at which the sound pressure level (or other stated characteristic) decreases at a given point and at a given time. A commonly used unit is the decibel per second.

RESONANCE*

of a system in forced oscillation exists when any change however small in the frequency of excitation causes a decrease in the response of the system. Note: Velocity resonance, for example, may occur at a frequency different from that of displacement resonance.

**RESONANCE FREQUENCY
(RESONANT FREQUENCY)***

a frequency at which resonance exists. Note: In case of possible confusion the type of resonance must be indicated: e.g., velocity resonance frequency.

RESPONSE*

of a device or system is the motion (or other output) resulting from an excitation (stimulus) under specified conditions. Note 1: Modifying phrases must be prefixed to the term response to indicate kinds of input and output that are being utilized. Note 2: The response characteristic, often presented graphically, gives the response as a function of some independent variable such as frequency or direction. For such purposes it is customary to assume that other characteristics of the input (for example, voltage) are held constant.

REVERBERATION*

1. the persistence of sound in an enclosed space, as a result of multiple reflections after the sound source has stopped.
2. the sound that persists in an enclosed space, as a result of repeated reflection or scattering, after the source of sound has stopped.

Note: The repeated reflections of residual sound in an enclosure can alternatively be described in terms of the transient behavior of the modes of vibration of the medium bounded by the enclosure.

REVERBERATION TIME*

of a room is the time that would be required for the mean squared sound pressure level therein, originally in a steady state, to decrease 60 dB after the source is stopped.

ROOT-MEAN SQUARE (rms)

square root of the arithmetical mean of the squares of a set of instantaneous amplitudes, or of a set of values of a function of time or other variable.

SAMPLING

transformation of a continuous function into a discrete series of values in appropriate order.

SIGMA (σ)

See STANDARD DEVIATION.

SIMPLE SOUND SOURCE*

a source that radiates sound uniformly in all directions under free-field conditions.

SIMPLE TONE (PURE TONE)*

1. a sound wave, the instantaneous sound pressure of which is a simple sinusoidal function of the time.
2. a sound sensation characterized by its singleness of pitch.

Note: Whether or not a listener hears a tone as simple or complex is dependent upon ability, experience, and listening attitude.

SOCIOCUSIS

increase in hearing-threshold level resulting from noise exposures that are part of the social environment, exclusive of occupational-noise exposure, physiologic changes with age, and otologic disease.

SONE*

a unit of loudness. By definition, a simple tone of frequency 1000 Hz, 40 dB above a listener's threshold, produces a loudness of 1 sone. The loudness of any sound that is judged by the listener to be n times that of the 1-sone tone is n sones. **Note 1:** A millisone is equal to 0.001 sone. **Note 2:** The loudness scale is a relation between loudness and level above threshold for a particular listener. In presenting data relating loudness in sones to sound pressure level, or in averaging the loudness scales of several listeners, the thresholds (measured or assumed) should be specified.

SONICS*

the technology of sound in processing and analysis. Sonics includes the use of sound in any noncommunication process.

SOUND*

1. an oscillation in pressure, stress, particle displacement, particle velocity, etc., in a medium with internal forces (e.g. elastic, viscous), or the superposition of such propagated alterations.
2. an auditory sensation evoked by the oscillation described above.

Note 1: In case of possible confusion the term "sound wave" or "elastic wave" may be used for concept (1), and the term "sound sensation" for concept (2). Not all sound waves can evoke an auditory sensation: e.g. ultrasound. **Note 2:** The medium in which the source exists is often indicated by an appropriate adjective: e.g. airborne, waterborne, structureborne.

SOUND ABSORPTION*

the change of sound energy into some other form, usually heat, in passing through a medium or on striking a surface.

SOUND EXPOSURE LEVEL

the level of the sound pressure squared, integrated over a given time. The reference quantity is $(20\mu\text{Pa})^2 \times 1$ second.

SOUND INTENSITY (SOUND POWER DENSITY) (SOUND-ENERGY FLUX DENSITY)*

in a specified direction at a point is the average rate of sound energy transmitted in the specified direction through a unit area normal to this direction at the point considered.

SOUND-LEVEL (NOISE LEVEL)**

weighted sound-pressure level measured by the use of a metering characteristic and weighting A, B, or C, as specified in American National Standard Specification for Sound-Level Meters, S1.4-1971, or the latest approved revision thereof. The weighting employed must be indicated, otherwise the A weighting is understood. The reference pressure is 20 micropascals (2×10^{-4} microbar).

SOUND-PRESSURE LEVEL*

in dB, is 20 times the logarithm to the base 10 of the ratio of the pressure of this sound to the reference pressure. The reference pressure shall be explicitly stated.

Note 1: The following reference pressures are in common use:

(a) 20 μ Pa (2×10^{-4} microbar) [20 μ N/m²]

(b) 1 microbar

(c) 1 pascal

Reference pressure (a) is in general use for measurements concerned with hearing and with sound in air and liquids, (b) has gained widespread acceptance for calibrations of transducers and various kinds of sound measurements in liquids, but (c) is now preferred for transducer calibrations in air.

[The reference pressure used in this handbook is 20 micropascals (20 μ Pa) (20 μ N/m²).] Note 2: Unless otherwise explicitly stated, it is to be understood that the sound pressure is the effective (rms) sound pressure. Note 3: It is to be noted that in many sound fields the sound-pressure ratios are not the square roots of the corresponding power ratios.

SPECTRUM*

1. of a function of time is a description of its resolution into components, each of different frequency and (usually) different amplitude and phase.
2. also used to signify a continuous range of components, usually wide in extent, within which waves have some specified common characteristic; e.g., "audio-frequency spectrum."

Note 1: The term is also applied to functions of variables other than time, such as distance.

SPECTRUM LEVEL (ACOUSTICS)

ten times the common logarithm of the ratio of the squared sound-pressure-per-unit-bandwidth to the corresponding reference quantity. The unit bandwidth is the hertz and the corresponding reference quantity is $(20 \mu\text{Pa})^2/\text{Hz}$.

SPEECH INTERFERENCE LEVEL

See PSIL.

STANDARD BAND NUMBER

ten times the logarithm to the base 10 of the ratio of the center frequency of a band in hertz to 1 hertz.

STANDARD DEVIATION (SIGMA, σ)

linear measure of variability equal to the square root of the variance.

STANDING WAVE*

periodic wave having a fixed distribution in space which is the result of interference of progressive waves of the same frequency and kind; characterized by the existence of nodes or partial nodes and anti-nodes that are fixed in space.

STATIONARY (STATISTICAL)

term that describes a noise whose spectrum and amplitude distribution do not change with time.

THIRD OCTAVE (See ONE-THIRD OCTAVE)

THRESHOLD OF AUDIBILITY (THRESHOLD OF DETECTABILITY)*

for a specified signal is the minimum effective-sound-pressure level of the signal that is capable of evoking an auditory sensation in a specified fraction of the trials. The characteristics of the signal, the manner in which it is presented to the listener, and the point at which the sound pressure level is measured must be specified. Note 1: Unless otherwise indicated, the ambient noise reaching the ears is assumed to be negligible. Note 2: The threshold is usually given as a sound-pressure level in decibels, relative to 20 μ Pa. Note 3: Instead of the method of constant stimuli, which is implied by the phrase "a specified fraction of the trials," another psychophysical method (which should be specified) may be employed.

THRESHOLD OF FEELING (OR TICKLE)*

for a specified signal is the minimum sound-pressure level at the entrance to the external auditory canal which, in a specified fraction of the trials, will stimulate the ear to a point at which there is a sensation of feeling that is different from the sensation of hearing.

TIF (TELEPHONE INFLUENCE FACTOR)

an index of the potential interfering effect of a particular power circuit on a telephone circuit. (See AIEE Trans. Vol. 79, Part I, 1960, pp. 659-664.)

TIME AVERAGE

the average of a function of time over a given time interval.

TIME SERIES

values ordered in time, a succession of discrete observations made at points in time or covering discrete intervals of time. The spacing of observations is ordinarily uniform on the time scale.

TONE*

- (a) a sound wave capable of exciting an auditory sensation having pitch.
- (b) a sound sensation having a pitch.

TRANSDUCER*

a device capable of being actuated by waves from one or more transmission systems or media and of supplying related waves to one or more other transmission systems or media. Note: The waves in either input or output may be of the same or different types (e.g., electrical, mechanical, or acoustic).

TRANSFER FUNCTION

measure of the relation between the output signal and the input signal of a system or device, ordinarily the ratio of the output signal to the input signal.

TRANSIENT VIBRATION*

temporarily sustained vibration of a mechanical system. It may consist of forced or free vibration or both.

ULTRASONICS*

the technology of sound at frequencies above the audio range. Note: Supersonics is the general subject covering phenomena associated with speed higher than the speed of sound (as in the case of aircraft and projectiles traveling faster than sound). This term was once used in acoustics synonymously with "ultrasonics"; such usage is now deprecated.

VARIANCE

quadratic measure of variability, the average of the mean squares of the deviations from the arithmetic mean of a set of values of a variable.

VELOCITY*

a vector that specifies the time-rate-of-change of displacement with respect to a reference frame. Note: If the reference frame is not inertial, the velocity is often designated relative velocity.

VIBRATION*

an oscillation wherein the quantity is a parameter that defines the motion of a mechanical system.

VIBRATION ISOLATOR*

a resilient support that tends to isolate a system from steady-state excitation.

VIBRATION METER (VIBROMETER)*

an apparatus for the measurement of displacement, velocity, or acceleration of a vibrating body.

WAVEFORM

instantaneous amplitude as a function of time.

WAVEFORM AVERAGING (SUMMATION ANALYSIS)

summing of corresponding ordinates of selected frames of a wave. The summed values may be divided by the number of frames summed to convert to an average.

WEIGHTING**

prescribed frequency response provided in a sound-level meter.

WHITE NOISE

power per-unit-frequency interval is substantially independent of frequency over a specified range. Note: White noise need not be random.

*This material is reproduced from the American National Standard Acoustical Terminology, S1.1-1960, copyrighted by ANSI, copies of which may be purchased from the American National Standards Institute at 1430 Broadway, New York, NY 10018.

**ANSI S1.4-1971.

***ANSI S3.6-1969.

Appendix VI

Words Commonly Used to Describe Sounds

The words listed below are commonly used to describe sounds of various types. Such words are often helpful in conveying information on the general nature of a sound.

| | | | | |
|---------|----------|-----------|----------|-----------|
| BANG | CLUCK | HUM | RING | SWOOSH |
| BARK | CLUNK | JINGLE | RIPPLING | TAP |
| BEEP | CRACK | JANGLE | ROAR | TATTOO |
| BELLOW | CRACKLE | KACHUNK | RUMBLE | TEARING |
| BLARE | CRASH | KNOCK | RUSHING | THROB |
| BLAST | CREAK | MEW | RUSTLE | THUD |
| BLAT | DINGDONG | MOAN | SCREAM | THUMP |
| BLEAT | DRIP | MOO | SCREECH | THUNDER |
| BONG | DRUMMING | MURMUR | SCRUNCH | TICK |
| BOOM | FIZZ | NEIGH | SHRIEK | TICK-TOCK |
| BRAY | GLUG | PATTER | SIZZLE | TINKLE |
| BUZZ | GNASHING | PEAL | SLAM | TOOT |
| CACKLE | GOBBLE | PEEP | SNAP | TRILL |
| CHEEP | GRATING | PING | SNARL | TWANG |
| CHIME | GRINDING | POP | SNORT | TWITTER |
| CHIRP | GROAN | POW | SPLASH | WAIL |
| CLACK | GROWL | POUNDING | SPUTTER | WHEEZE |
| CLANG | GRUMBLE | PULSING | SQUAWK | WHINE |
| CLANK | GRUNT | PURR | SQUEAK | WHIR |
| CLAP | GURGLE | PUT-PUT | SQUEAL | WHISPER |
| CLATTER | HISS | RAP | SQUISH | WHISTLE |
| CLICK | HOOT | RAT-A-TAT | STAMP | YAP |
| CLINK | HOWL | RATTLE | SWISH | YELP |
| | | | | ZAP |

Appendix VII

Standards and Journals

Standards

An extensive list of standards concerned with acoustics has been compiled in the NBS Special Publication 386, *Standards on Noise Measurements, Rating Schemes, and Definitions: A Compilation*, Supt of Documents, US Govt Printing Office, Washington, DC 20402, SD Catalog #C13.10:386. This list includes a brief summary of the scope of each standard.

The Acoustical Society of America also publishes an index to noise standards, *ASA STDS INDEX 1-1976*.

The following standards in acoustics and mechanical shock and vibration can be purchased from the American National Standards Institute, (ANSI) 1430 Broadway, New York, NY 10018. the S1, S2, and S3 standards (except for the ASTM and IEEE standards) are also available from Standards Secretariat of the Acoustical Society of America, AIP Back Numbers Dept., DEPT STD, 335 East 45th Street, New York, NY 10017.

| | |
|--------------------|---|
| S1.1-1960 (R1976) | Acoustical Terminology |
| S1.2-1960 (R1976) | Physical Measurement of Sound |
| S1.4-1971 (R1976) | Sound Level Meters |
| S1.5-1963 (R1971) | Loudspeaker Measurements (IEEE 219-1961) |
| S1.6-1967 (R1976) | Preferred Frequencies for Acoustical Measurements |
| S1.7-1970 | Method of Test for Sound Absorption of Acoustical Materials in Reverberation Rooms (ASTM C423-66) |
| S1.8-1969 (R1974) | Preferred Reference Quantities for Acoustical Levels |
| S1.10-1966 (R1976) | Calibration of Microphones |
| S1.11-1966 (R1976) | Octave, Half-Octave, and Third-Octave Band Filter Sets |
| S1.12-1967 (R1977) | Laboratory Standard Microphones |
| S1.13-1971 (R1976) | Measurement of Sound Pressure Levels |
| S1.20-1972 (R1977) | Calibration of Underwater Electroacoustic Transducers |
| S1.21-1972 | Sound Power Levels of Small Sources in Reverberation Rooms |
| S1.23-1976 | Designation of Source Power Emitted by Machinery and Equipment |
| S1.25-1978 | Personal Noise Dosimeter |
| S1.26-1978 | Calculation of the Absorption of Sound by the Atmosphere |
| S1.27-1978 | E-Weighting Network for Noise Measurements |
| S2.2-1959 (R1976) | Calibration of Shock and Vibration Pickups |
| S2.3-1964 (R1976) | High-Impact Shock Machine for Electronic Devices |
| S2.4-1976 | Specifying the Characteristics of Auxiliary Analog Equipment for Shock and Vibration Measurements |
| S2.5-1962 (R1976) | Specifying the Performance of Vibrating Machines |
| S2.6-1963 (R1976) | Specifying the Mechanical Impedance of Structures |
| S2.7-1964 (R1976) | Terminology for Balancing Rotating Machinery |
| S2.8-1972 | Describing the Characteristics of Resilient Mountings |
| S2.9-1976 | Nomenclature for Material Damping Properties |
| S2.10-1971 (R1976) | Analysis and Presentation of Shock and Vibration Data |
| S2.11-1969 (R1973) | Calibrations and Tests for Electrical Transducers Used for Measuring Shock and Vibration |
| S2.14-1973 | Specifying the Performance of Shock Machines |
| S2.15-1972 (R1977) | Design Construction and Operation of Class HI (High-Impact) Shock-Testing Machine for Lightweight Equipment |
| S2.19-1975 | Balance Quality of Rotating Rigid Bodies |
| S3.1-1977 | Criteria for Permissible Ambient Noise during Audiometric Testing |

| | |
|--------------------|---|
| S3.2-1960 (R1976) | Measurement of Monosyllabic Word Intelligibility |
| S3.3-1960 (R1976) | Measurement of Electroacoustical Characteristics of Hearing Aids |
| S3.4-1968 (R1972) | Computation of the Loudness of Noise |
| S3.5-1969 (R1971) | Calculation of the Articulation Index |
| S3.6-1969 (R1973) | Specifications for Audiometers |
| S3.7-1973 | Coupler Calibration of Earphones |
| S3.8-1967 (R1976) | Expressing Hearing Aid Performance |
| S3.13-1972 (R1977) | Artificial Head-Bone for the Calibration of Audiometer Bone Vibrators |
| S3.14-1977 | Rating Noise with Respect to Speech Interference |
| S3.17-1975 | Rating the Sound Power Spectra of Small Stationary Noise Sources |
| S3.19-1974 | Measurement of Real-Ear Protection of Hearing Protectors and Physical Attenuation of Earmuffs |
| S3.20-1973 | Psychoacoustical Terminology |
| S3.21-1978 | Methods for Manual Pure-Tone Threshold Audiometry |
| S3.22-1976 | Specification of Hearing Aid Characteristics |
| S3-W-39 | Effects of Shock and Vibration on Man |
| S5.1-1971 | CAGI-PNEUROP Test Code for the Measurement of Sound from Pneumatic Equipment |
| S6.1-1973 | Qualifying a Sound Data Acquisition System (SAE J184-1973) |
| S6.2-1973 | Exterior Sound Level for Snowmobiles (SAE J192a-1973) |
| S6.3-1973 | Sound Level for Passenger Cars and Light Trucks (SAE J986b-1973) |
| S6.4-1973 | Computing the Effective Perceived Noise Level for Flyover Aircraft Noise (SAE ARP 1071-1973) |
| Y10.11-1953 | Letter Symbols for Acoustics |
| Y32.18-1972 | Symbols for Mechanical and Acoustical Elements as Used in Schematic Diagrams |
| Z24-X-2 | The Relations of Hearing Loss to Noise Exposure |

The following are standards of the International Electrotechnical Commission: (available from ANSI)

| | |
|-----------------|--|
| IEC/50-08(1960) | International Electrotechnical Vocabulary Group 08: Electro-Acoustics |
| IEC/118(1959) | Measurements of the Electro-Acoustical Characteristics of Hearing Aids |
| IEC/124(1960) | Rated Impedances and Dimensions of Loudspeakers |
| IEC/126(1973) | IEC Reference Coupler for the Measurement of Hearing Aids Using Earphones Coupled to the Ear by Means of Ear Inserts |
| IEC/177(1965) | Pure Tone Audiometers for General Diagnostic Purposes |
| IEC/178(1965) | Pure Tone Screening Audiometers |
| IEC/184(1965) | Specifying the Characteristics of Electromechanical Transducers for Shock and Vibration Measurements |
| IEC/200(1966) | Measurement of Loudspeakers |
| IEC/222(1966) | Specifying the Characteristics of Auxiliary Equipment for Shock and Vibration Measurement |
| IEC/225(1966) | Octave, Half-Octave and Third-Octave Band Filters Intended for the Analysis of Sounds and Vibrations |
| IEC/263(1975) | Scales and Sizes for Plotting Frequency Characteristics |
| IEC/303(1970) | IEC Provisional Reference Coupler for the Calibration of Earphones Used in Audiometry |
| IEC/318(1970) | IEC Artificial Ear, of the Wide Band Type, for the Calibration of Earphones used in Audiometry |
| IEC/327(1971) | Precision Method for Pressure Calibration of One-inch Standard Condenser Microphones by the Reciprocity Technique |
| IEC/373(1971) | IEC Mechanical Coupler for the Calibration of Bone Vibrators |
| IEC/402(1972) | Simplified Method for Pressure Calibration of One-inch Condenser Microphones by the Reciprocity Technique |

| | |
|---------------|--|
| IEC/486(1974) | Precision Method for the Free-Field Calibration of One-inch Condenser Microphones by the Reciprocity Technique |
| IEC/537(1976) | Frequency Weighting for the Measurement of Aircraft Noise |
| IEC/651(1979) | Sound Level Meters |

The following are recommendations of the International Organization for Standardization: (available from ANSI)

| | |
|-----------------------|--|
| ISO/R16-1965 | Standard Tuning Frequency |
| ISO/R31/Part VII-1965 | Quantities and Units of Acoustics |
| ISO/R131-1959 | Expression of the Physical and Subjective Magnitudes of Sound or Noise |
| ISO/R140-1960 | Field and Laboratory Measurements of Airborne and Impact Sound Transmission |
| ISO/R226-1961 | Normal Equal-Loudness Contours for Pure Tones |
| ISO/266-1975 | Preferred Frequencies for Acoustical Measurements |
| ISO/R354-1963 | Measurement of Absorption Coefficients in a Reverberation Room |
| ISO/R357-1963 | Power and Intensity Levels of Sound or Noise |
| ISO/R362-1964 | Measurement of Noise Emitted by Vehicles |
| ISO/389-1975 | Reference Zero for Pure-Tone Audiometers |
| ISO/R454-1965 | Relation Between Sound Pressure Levels of Narrow Bands of Noise in a Diffuse Field and in a Frontally-Incident Free Field for Equal Loudness |
| ISO/R495-1966 | Preparation of Test Codes for Measuring the Noise Emitted by Machines |
| ISO/R507-1970 | Describing Aircraft Noise Around an Airport |
| ISO/532-1975 | Calculating Loudness Level |
| ISO/R717-1968 | Rating of Sound Insulation for Dwellings |
| ISO/R1680-1970 | Test Code for the Measurement of the Airborne Noise Emitted by Rotating Electrical Machinery |
| ISO/R1761-1970 | Monitoring Aircraft Noise Around an Airport |
| ISO/R1996-1971 | Acoustics — Assessment of Noise with Respect to Community Response |
| ISO/R1999-1975 | Acoustics — Assessment of Occupational Noise Exposure for Hearing Conservation Purposes |
| ISO/R2151-1972 | Measurement of Airborne Noise Emitted by Compressor/Prime-mover Units Intended for Outdoor Use |
| ISO/R2204-1973 | Guide to the Measurement of Acoustical Noise and Evaluation of Its Effect on Man |
| ISO/2249-1973 | Acoustics — Description and Measurement of Physical Properties of Sonic Booms |
| ISO/2922-1975 | Acoustics — Measurements of Noise Emitted by Vessels on In-land Water-Ways and Harbours |
| ISO/2923-1975 | Acoustics — Measurement of Noise on Board Vessels |
| ISO/3095-1975 | Acoustics — Measurement of Noise Emitted by Railbound Vehicles |
| ISO/TR 3352-1974 | Acoustics — Assessment of Noise with Respect to its Effect on the Intelligibility of Speech |
| ISO 3381-1976 | Acoustics — Measurement of Noise Inside Railbound Vehicles |
| ISO 3740-1978 | Acoustics — Determination of Sound Power Levels of Noise Sources — Guidelines for the Use of Basic Standards and for the Preparation of Noise Test Codes |
| ISO 3741-1975 | Acoustics — Determination of Sound Power Levels of Noise Sources — Precision Methods for Broad-Band Sources in Reverberation Rooms |
| ISO 3742-1975 | Acoustics — Determination of Sound Power Levels of Noise Sources — Precision Methods for Discrete-Frequency and Narrow-Band Sources in Reverberation Rooms |
| ISO 3743-1977 | Acoustics — Determination of Sound Power Levels of Noise Sources — Engineering Methods for Special Reverberation Test Rooms |

- ISO 3744-1978 Acoustics — Determination of Sound Power Levels of Noise Sources — Engineering Methods for Free-Field Conditions Over a Reflecting Plane
- ISO 3745-1977 Acoustics — Determination of Sound Power Levels of Noise Sources — Precision Methods for Anechoic and Semi-Anechoic Rooms.

Standards Prepared by Professional Societies

Acoustical Society of America (AIP Back Numbers Dept, Dept STD) 333 East 45th Street, New York, NY 10017.

The Acoustical Society of America, whose committees S1, S2, and S3 prepare most of the standards that become the S1, S2, and S3 standards of ANSI, also has some standards that are designated ASA/STD's. Most of these are the same as certain ANSI standards.

- ASA STD 1-1975 (ANSI S3.19-1974)
- ASA STD 2-1975 (ANSI S2.19-1975)
- ASA STD 3-1975 Test Site Measurement of Maximum Noise Emitted by Engine-Powered Equipment
- ASA STD 4-1975 (ANSI S3.17-1975)
- ASA STD 5-1976 (ANSI S1.23-1976)
- ASA STD 6-1976 (ANSI S2.9-1976)
- ASA STD 7-1976 (ANSI S3.22-1976)
- ASA STD 8-1976 (ANSI S2.4-1976)
- ASA STD 9-1977 (ANSI S3.1-1977)
- ASA STD 19-1978 (ANSI S3.21-1978)
- ASA STD 21-1977 (ANSI S3.14-1977)
- ASA STD 23-1978 (ANSI S1.26-1978)
- ASA STD 25-1978 (ANSI S1.25-1978)
- ASA STD 26-1978 (ANSI S1.27 Draft Standard)

American Society for Testing and Materials, 1916 Race St., Philadelphia, PA 19103

- C367-57 Strength Properties of Prefabricated Architectural Acoustical Materials
- C384-58(R1972) Impedance and Absorption of Acoustical Materials by the Tube Method
- C423-77 Test for Sound Absorption and Sound Absorption Coefficients by the Reverberation Room Method
- C522-69 Test Method for Airflow Resistance of Acoustical Materials
- C643-69 Painting Ceiling Materials for Acoustical Absorption Tests
- E90-75 Laboratory Measurement of Airborne Sound Transmission Loss of Building Partitions
- E336-77 Measurement of Airborne Sound Insulation in Buildings
- C636-69 Installation of Metal Ceiling Suspension Systems for Acoustical Tile and Lay-In Panels
- C634-73 Definition of Terms Relating to Environmental Acoustics
- E413-73 Standard Classification for Determination of Sound Transmission Class
- E477-73 Testing Duct Liner materials and Prefabricated Silencers for Acoustical and Airflow Performance
- E492-73T Laboratory Measurement of Impact Sound Transmission Through Floor Ceiling Assemblies Using the Tapping Machine
- E497-73T Installation of Fixed Partitions of Light Frame Type for the Purpose of Conserving Their Sound Insulating Efficiency

American Society of Heating, Refrigerating and Air-Conditioning Engineers (ASHRAE), 345 East 47th Street, New York, NY 10017

- 36-72 Methods of Testing for Sound Rating Heating, Refrigerating, and Air-Conditioning Equipment
- 68-75 Method of Testing Sound Power Radiated into Ducts from Air Moving Devices

Institute of Electrical and Electronic Engineers, 345 East 47th Street, New York, NY 10017

IEEE 85-1973 Airborne Sound Measurements on Rotating Electric Machinery
IEEE 219-1975 Loudspeaker Measurements (ANSI S1.5-1963)(R1971)
IEEE 258-1965 Methods of Measurement for Close-Talking Pressure Type
Microphones
IEEE 269-1966 Method for Measuring Transmission Performance of Telephone
Sets
IEEE 297-1969 Recommended Practice for Speech Quality Measurements

Instrument Society of America, 400 Stanwix St., Pittsburgh, PA 15222.
RP37.2 Guide for Specifications and Tests for Piezoelectric Acceleration
Transducers for Aerospace Testing (1964)
S37.10 Specification and Tests for Piezoelectric Pressure and Sound-
Pressure Transducers (1969)

Society of Automotive Engineers, 400 Commonwealth Drive, Warrendale, PA 15096.
SAE Committee A-21, Aircraft Noise Measurement

ARP 796 Measurements of Aircraft Exterior Noise in the Field
AIR 817 A Technique for Narrow Band Analysis of a Transient
AIR 852 Methods of Comparing Aircraft Takeoff and Approach Noises
ARP 865a Definitions and Procedures for Computing the Perceived Noise
Level of Aircraft Noise
ARP 866a Standard Values of Absorption as a Function of Temperature
and Humidity for Use in Evaluating Aircraft Flyover Noise
AJR 876 Jet Noise Prediction
AIR 902 Determination of Minimum Distance from Ground Observer to
Aircraft for Acoustic Tests
AIR 923 Method for Calculating the Attenuation of Aircraft Ground to
Ground Noise Propagation During Takeoff and Landing
ARP 1071 Computing the Effective Perceived Noise Level for Aircraft
Noise
AIR 1079 Aircraft Noise Research Needs
ARP 1080 Frequency Weighting Network for Approximation of Perceived
Noise Level for Aircraft Noise
AIR 1081 House Noise-Reduction Measurements for Use in Studies of
Aircraft Flyover Noise
AIR 1115 Evaluation of Headphones for Demonstration of Aircraft Noise
AIR 1216 Comparisons of Ground Runup and Flyover Noise Levels

SAE Sound Level Committee

J6a Ride and Vibration Data Manual
J34a Exterior Sound Level Measurement Procedures for Pleasure
Motorboats
J47 Maximum Sound Level Potential for Motorcycles
J57 Sound Level of Highway Truck Tires
J88a Exterior Sound Level Measurement Procedures for Powered
Mobile Construction Equipment
J184 Qualifying a Sound Data Acquisition System (ANSI S6.1-1973)
J192a Exterior Sound Level for Snowmobiles (ANSI S6.2-1973)
J331a Sound Levels for Motorcycles
J336a Sound Level for Truck Cab Interior
J366b Exterior Sound Level for Heavy Trucks and Buses
J377 Performance of Vehicle Traffic Horns
J672a Exterior Loudness Evaluation of Heavy Trucks and Buses
J919b Sound Level Measurements at the Operator Station for Agri-
cultural and Construction Equipment
J952b Sound Levels for Engine Powered Equipment
J986B Sound Level for Passenger Cars and Light Trucks
J994b Criteria for Backup Alarm Devices

| | |
|--------|--|
| J1030 | Maximum Sound Level for Passenger Cars and Light Trucks |
| J1046a | Exterior Sound Level Measurement Procedure for Small Engine Power Equipment |
| J1060 | Subjective Rating Scale for Evaluation of Noise and Ride Comfort Characteristics Related to Motor Vehicle Tires |
| J1074 | Engine Sound Level Measurement Procedure |
| J1077 | Measurement of Exterior Sound Level of Trucks with Auxiliary Equipment |
| J1096 | Measurement of Exterior Sound Levels for Heavy Trucks under Stationary Conditions |
| J1105 | Performance, Test and Application Criteria of Electrically Operated Forward Warning Horn for Mobile Construction Machinery |
| J1169 | Measurement of Light Vehicle Exhaust Sound Level under Stationary Conditions |

Industry Groups

Air Conditioning and Refrigeration Institute (ARI), 1815 North Fort Meyer Drive, Arlington, Virginia 22209

| | |
|------------|--|
| ARI 270-67 | Sound Rating of Outdoor unitary Equipment |
| ARI-275-69 | Application of Sound Rated Outdoor Unitary Equipment |
| ARI-443-70 | Rooms Fan-Cool Air Conditioners |
| ARI-446-68 | Sound Rating of Room Air-Induction Units |
| ARI-575-73 | Measuring Machinery Sound within Equipment Rooms |

Air Diffusion Council (ADC), 435 North Michigan Ave., Chicago, IL 60611

| | |
|---------------|--|
| AD-63 | Measurement of Room-to-Room Sound Transmissions Through Plenum Air Systems |
| 1062-R3(1972) | Equipment Test Code |
| FD-72 | Flexible Air Duct Test Code |

Air Moving and Conditioning Association (AMCA), 30 West University Drive, Arlington Heights, IL 60004

| | |
|--------------------|--|
| Bulletin 300-67 | Test Code for Sound Rating |
| Bulletin 301-65 | Method of Publishing Sound Ratings for Air Moving Devices |
| Bulletin 302-65 | Application of Sone Loudness Ratings for Non-Ducted Air Moving Devices |
| Bulleting 303-65 | Application of Sound Power Level Ratings for Ducted Air Moving Devices |
| Publication 311-67 | AMCA Certified Sound Ratings Program for Air Moving Devices |

American Gear Manufacturers Association (AGMA), 1330 Massachusetts Ave., N.W., Washington, DC 20005

| | |
|--------------|---|
| 295.03(1968) | Specification for Measurement of Sound on High Speed Helical and Herringbone Gear Units |
| 297.01(1973) | Sound for Enclosed Helical, Herringbone and Spiral level Gear Drives |
| 298.01(1975) | Sound for Gearmotors and In-Line Reducers and Increases |

American Petroleum Institute, Refining Department, 2101 L Street, NW, Washington, DC 20037

| | |
|---------|--|
| API-670 | Non Contacting Vibration and Axial Position Monitoring System, June 1976 |
|---------|--|

American Textile Machinery Association, 1730 M Street, NW, Washington, DC 20036

- ATMA Test Procedure Noise Measurement Technique for Textile Machinery (1973)
- The Anti-Friction Bearing Manufacturers Association, Inc., 60 East 42nd Street, New York, NY 10017
- AFBMA Standard, Section 13, Roller Bearing Vibration and Noise
- Association of Home Appliance Manufacturers, 20 North Wacker Drive, Chicago, IL 60606
- Standard RAC-2-SR Room Air Conditioner Sound Rating, January 1971
- Compressed Air and Gas Institute (CAGI), 2130 Keith Building, Cleveland, OH 44115
- (see ANSI S5.1-1971)
- Diesel Engine Manufacturers Association, 2130 Kieth Building, Cleveland, OH 44115
- Test Code (1972) For the Measurement of Sound from Heavy-Duty Reciprocating Engines
- Home Ventilating Institute, 230 North Michigan Ave., Chicago, IL 60601
- Sound Test Procedure (1974)
- Industrial Silencer Manufacturers Association, c/o Burgess Industries, P.O. Box 47146, Dallas, TX 75247
- Insertion Loss Measurement of Intake and Exhaust Silencers for Reciprocating Engines (1974)
- Measurement of Silenced Sound Leaks and/or Unsilenced Sound Levels and Insertion Loss, of Reciprocating Engine Intake and Exhaust Systems
- International Conference of Building Officials, 5360 South Workman Mill Road, Whittier, CA 90601
- UBC 35-1 Determination of Airborne Sound Transmission Class
- UBC 35-2 Impact Sound Insulation
- UBC 35-3 Airborne Sound Insulation Field Test
- National Electrical Manufacturers Association, 845 15th Street, Suite 438, Washington, DC 20005
- LE2-1974 H-I-D Lighting System Noise Criterion Ratings
- MG1-12.49(1972) Motor and Generators. Method of Measuring Machine Noise
- TR1-1974 Transformers, Regulators and Reactors (Sections 9-04 and 9-05)
- SM33-1964 Standards Publication, Gas Turbine Sound and Its Reduction
- National Fluid Power Association, 3333 N. Mayfair Road, Milwaukee, WI 53222
- NFPA T3.9.12(R1975) Method of Measuring Sound Generated by Hydraulic Fluid Power Pumps
- NFPA T3.9.14-1971 Method of Measuring Sound Generated by Hydraulic Fluid Power Motors
- National Machine Tool Builders Association (NMTBA), 7901 West Park Drive, McLean, VA 22101
- Noise Measurement Techniques, June 1970

Power Saw Manufacturers Association, Box 7256, Belle View Station, Alexandria, VA 22307

N1.1-66 Noise Level
N2.1-67 Noise Octave Band Measurement

Woodworking Machinery Manufacturers Association, 1900 Arch Street, Philadelphia, PA 19103

Test Code (1973) Evaluating the Noise Emission of Woodworking Machinery

Journals in the field of Sound and Vibration.

- Acustica*, S. Hirzel, Stuttgart 1, Birkenwaldstr. 44, Postfach 347, Germany. (An international journal on acoustics.)
- Akusticheskii Zhurnal*, (in Russian), Academy of Sciences of USSR, Moscow.
- Applied Acoustics*, Applied Science Publishers Ltd., Ripple Road, Barking, Essex, England. (An international journal.)
- IEEE Transactions on Audio and Electroacoustics*, The Institute of Electrical and Electronics Engineers, Inc., 345 East 47 Street, New York, NY 10017.
- The Journal of the Acoustical Society of America*, Acoustical Society of America, 335 East 45 Street, New York, NY 10017. (The most comprehensive scientific journal in acoustics with occasional papers on vibration. The Society also publishes cumulative indexes to the *Journal* and to other acoustical literature.)
- The Journal of the Acoustical Society of Japan*, (in Japanese), Acoustical Society of Japan, Ikeda Building/2-7-7, Yoyogi, Shibuya-Ku, Tokyo, Japan.
- Journal of the Audio Engineering Society*, Audio Engineering Society, Room 929, Lincoln Building, 60 East 42nd Street, New York, NY 10017.
- Journal of Auditory Research*, The C.W. Skilling Auditory Research Center, Inc., Box N, Grotton, Connecticut 06340.
- Journal of Sound and Vibration*, Academic Press, Inc., Limited, Berkeley Square House, Berkeley Square, London W1X 6BA and Academic Press Inc., 111 Fifth Avenue, New York, NY 10003. (An official medium of publication for the British Acoustical Society.)
- Kampf Dem Larm*, (in German), J.F. Lehmanns Verlag, Agnes-Bernauerplatz 8, 8000 Munchen 21, Germany.
- Larmbekämpfung*, (in German), Verlag Fur Angewandte Wissenschaften GmbH, Hardstrasse 1, 757 Baden-Baden, Germany.
- Noise Control Engineering and Noise/News*, Institute of Noise Control Engineering, P.O. Box 3206, Arlington Branch, Poughkeepsie, NY 12601. (Published in cooperation with the Acoustical Society of America.)
- Noise Control Report*, P.O. Box 1067, Blair Station, Silver Springs, MD 20910.
- Noise Control Vibration Isolation*, Trade & Technical Press Ltd., Crown House, Morden, Surrey, England.
- Noise Regulation Reporter*, The Bureau of National Affairs, 1231 25th St., NW, Washington, DC 20037.
- Revu D'Acoustique* (in French), G.A.L.F. (Groupement des Acousticiens de Langue Francaise), Secretariat, *Department Acoustique du CNET, 22-Lannion, France. Subscription — 12, rue des Fosses-Saint-Marcel, 75005-Paris, France.*
- Sound and Vibration*, Acoustical Publications, Inc., 27101 E. Oviatt Road, Bay Village, OH 44140.

The following publish occasional reports:

- ISVR Technical Reports*, Institute of Sound and Vibration Research, The University, Southampton SO9 5NH, England.
- Acoustics Reports*, Acoustics Unit, National Physical Laboratory, Teddington, Middlesex, TW11 0LW, England.
- VDI Berichte*, Verein Deutscher Ingenieure, VDI-Kommission Larmminderung, 4 Dusseldorf 1, Graf-Recke-Strasse 84, Germany.

In the USA, numerous government and state agencies issue publications and regulations related to noise and vibration. Some of them are:

- Department of Transportation
- Environmental Protection Agency
- Federal Aviation Administration
- Housing and Urban Development
- Mine Safety and Health Administration
- National Bureau of Standards
- National Institute for Occupational Safety and Health
- Occupational Safety and Health Administration

Numerous other societies in the United States are interested in sound and vibration measurements, for example:

- American Hearing Society
- American Industrial Hygiene Association
- American Institute of Aeronautics and Astronautics
- American Medical Association
- American Psychological Association
- American Society of Heating, Refrigerating, and Air-Conditioning Engineers
- American Society for Testing and Materials
- American Speech and Hearing Association
- American Society of Mechanical Engineers
- Institute of Electrical and Electronic Engineers
- Institute of Environmental Sciences
- Instrument Society of America
- Society of Automotive Engineers
- Society of Experimental Psychologists
- Society of Experimental Stress Analysis

Many others in other countries, and many trade journals, publish occasional papers on acoustics, noise control and vibration.

Appendix VIII

GenRad Product Directory

The following pages include detailed specifications for GenRad sound- and vibration-measuring instruments and accessories; specifications given are subject to change without notice.

Instruments for Hearing Conservation

| | |
|---|-----|
| Sound-Level Meters | |
| 1933 Precision Sound-Level Meter and Analyzer | 315 |
| 1933 Sound Analysis Systems | 317 |
| 1982 Precision Sound-Level Meter and Analyzer | 323 |
| 1981-B Precision Sound-Level Meter | 326 |
| 1565-B Sound-Level Meter | 328 |
| Sound-Level Measurement Sets (Industrial Noise) | 329 |
| 1983 Sound-Level Meter | 332 |
| 1988 Precision Integrating Sound-Level Meter and Analyzer | 311 |
| Noise Dosimeters | |
| 1954 Noise Dosimeter | 334 |
| Calibrators | |
| 1986 Omnical Sound-Level Calibrator | 339 |
| 1987 Minical Sound-Level Calibrator | 341 |
| 1562-A Sound-Level Calibrator | 342 |
| 1565 Audiometer Calibration Set | 343 |
| 1933 Audiometer Calibration System | 344 |
| 1560-9619 Audiometer Calibration Accessory Kit | 345 |

Instruments for Community Noise Measurements

| | |
|---|-----|
| Sound-Level Meters | |
| 1933 Precision Sound-Level Meter and Analyzer | 315 |
| 1933 Sound Analysis Systems | 317 |
| 1982 Precision Sound-Level Meter and Analyzer | 323 |
| 1981-B Precision Sound-Level Meter | 326 |
| 1565-D Sound-Level Meter | 330 |
| Sound-Level Measurement Set (Community Noise) | 331 |
| 1983 Vehicle Noise Measurement Set | 333 |
| Calibrators | |
| 1986 Omnical Sound-Level Calibrator | 339 |
| 1987 Minical Sound-Level Calibrator | 341 |
| 1562-A Sound-Level Calibrator | 342 |
| Analizers and Recorders | |
| 1523 Graphic Level Recorder | 362 |
| 1945 Community Noise Analyzer | 370 |

Instruments for Product Noise Reduction

| | |
|---|-----|
| Sound-Level Meters | |
| 1933 Precision Sound-Level Meter and Analyzer | 315 |
| 1933 Sound Analysis Systems | 317 |
| 1982 Precision Sound-Level Meter and Analyzer | 323 |
| 1988 Precision Integrating Sound-Level Meter and Analyzer | 311 |
| Vibration Measuring Instruments | |
| 1933 Vibration Integrator System | 322 |
| Sound and Vibration Analyzers | |
| 1995 Integrating Real Time Analyzer | 348 |
| 2512 Spectrum Analyzer | 351 |
| 1925 Multifilter | 353 |
| 1564-A Sound and Vibration Analyzer | 355 |
| 1568-A Wave Analyzer | 356 |
| 1911-A Recording Sound and Vibration Analyzer | 358 |
| Recorders | |
| 1521-B Graphic Level Recorder | 359 |
| 1523 Graphic Level Recorder | 362 |
| 1985 DC Recorder | 368 |
| Calibrators | |
| 1986 Omnical Sound-Level Calibrator | 339 |
| 1987 Minical Sound-Level Calibrator | 341 |
| 1557-A Vibration Calibrator | 347 |
| Other Instruments, Transducers and Accessories | |
| Transducers | |
| Electret Microphones | 373 |
| Ceramic Microphones | 374 |
| Accessories (Preamps—Cables) | 375 |
| Vibration Pickups | 380 |
| Other Instruments | |
| 1396-B Tone-Burst Generator | 381 |
| 1840-A Output Power Meter | 382 |
| Random Noise Generators | 383 |
| 1390-P2 Pink-Noise Filter | 386 |
| 1952 Universal Filter | 389 |

1988 Precision Integrating Sound-Level Meter and Analyzer

- Automatically performs all integration for cumulative sound-level measurements like L_{eq} and SEL
- Ideal for measuring industrial, product, and community noise
- Lightweight (3 lb) and compact for easy handling
- Flexible power supplies for versatility
- Type 1 precision for all measurements
- Makes all measurements of integrating functions in addition to conventional sound-level measurements: peak and impulse readings, octave bands, and A, B, C, and flat weighting networks
- Connectable to a printer for hard-copy results

Whenever the sound-level varies with location or time, that's when an integrating sound-level meter is especially useful. The 1988 Precision Integrating Sound-Level Meter and Analyzer offers a combination of power, flexibility, and ease-of-use that is unmatched by any other integrating meter.

Basically, an integrating sound-level meter enables you to "capture" and "add up" the contributions of noise sources by averaging their levels over an extended period of time. Conventional sound-level meters, in principle, perform similar averaging, but the 1988 does so far more automatically and precisely.

The primary integrating parameters computed by the 1988 are the L_{eq} (equivalent continuous level, or average level) and the SEL (the sound exposure level). The 1988 also provides conventional sound-level readings. It incorporates 10 octave band filters, with center frequencies from 31.5 Hz to 16.0 kHz. It contains A, B, and C weighting networks, as well as a flat (no weighting) network, over a 5-Hz to 20-kHz range. Four detector-integrator characteristics provide a selection of fast, slow, peak, or impulse response in the continuous mode. In the integrating mode, fast response is normally used, but slow or impulse may be selected if desired. The 1988 provides direct readings for levels ranging from 30 to 140 dB (150-dB peak). Levels as low as 10 dB can be measured with an optional 1" microphone.

Used in virtually any application Many measurements made with conventional sound-level meters involve numerous, painstaking steps: repeated readings must be made at pre-specified intervals and locations; results must be manually recorded; anti-logos computed and added; logarithms determined; and final results established. The 1988 performs such tasks automatically and precisely. Since it can integrate over a period of up to 24 hours, the 1988 can make its readings unattended. And results can be retained for later reference by connecting the 1988 to a hard-copy printer.

These 1988 features can play an important role in a broad range of measurement applications:

Product Noise Measurements 1) Measures average dBA level of equipment (such as portable air compressors or truck-mounted solid waste compactors) as required by EPA regulations.



2) Measures L_{eq} of cyclical noise sources (such as machinery or home appliances) to develop a single number rating which describes the noise emission.

3) Measures octave-band levels to determine radiated noise spectrum.

4) Measures vibration levels with GenRad 1933-9610 Vibration Integrator System.

5) Measures time-weighted average levels of machine tools as required by NMTBA guidelines.

6) Measures sound exposure level (SEL) to determine energy content of short duration sounds.

Community Noise 1) Measures maximum Vehicle-Passby-Level. Background can be continuously measured on analog meter.

2) Measures 1-hour L_{eq} for highways/traffic period of the day, as required by some regulations.

3) Measures L_{eq} for 1 hour, 6 hours, or 24 hours, to establish existing levels before new plant is constructed.

4) Measures dBA, L_{eq} , or octave bands to meet noise codes at plant/community boundary lines.

Industrial Noise 1) Measures dBA and peak levels to determine OSHA compliance.

2) Measures octave-band levels to help plan noise reduction actions, evaluate hearing protectors, and select audiometric booth sites.

3) Measures L_{eq} (with Fast, Slow, or Impulse Detector response) and peak levels to evaluate industrial noise exposure and determine potential hearing damage.

Ease-of-Use Ease-of-use has not been sacrificed to provide the power and precision of the 1988. In fact, most tasks involve simple, pushbutton operations. Integration periods can be pre-set to run anywhere from 1 second to 24 hours. Consequently, in many cases the 1988 can be left unattended. (An optional weatherproof enclosure eliminates any need for worrying about leaving the 1988 out in inclement weather.)

A simple switch automatically locks the 1988 into operation in either the continuous (i.e., conventional) or integrating mode. In the continuous mode, operation is virtually the same as with any conventional sound-level meter. To integrate, you need only pre-enter the integration period. During operation, the results can be viewed on the digital LED display in a number of forms: L_{eq} , SEL, maximum sound level, or continuous sound level. Integration time limits as well as time remaining can also be displayed. Continuous readings are also presented on the 1988's analog meter.

Precision Sound-Level Measurement The 1988's conformance to ANSI Type 1 and IEC Sound-Level Meter Standard 651, Type 1, is your assurance of the most accurate performance offered in a sound-level meter. To make a measurement you simply switch to the weighting and meter response (fast or slow) you desire, switch on the meter, and set the attenuator to the range that gives you an on-scale reading. Then you read the measured levels from either the digital display or analog meter.

Octave-band analysis The octave-band filters in the 1988 are the most accurate offered in a portable instrument. This assures a high degree of confidence in your octave-band measurements. In addition, the 1988 eliminates the often confusing two-attenuator system used in other instruments. The 1988 features a single attenuator which allows you to set the range desired, switch on the instrument, and read the measured level from either display. Should the range level be set too low, an overload light on the meter face alerts you to change to a higher level, thus avoiding incorrect readings.

Peak and impulse measurement The 1988's peak detector is the fastest available for measuring impact- or impulse-type noise. With a 50-microsecond rise time, the detector ensures reading the true peak of the signal, up to 140 dB. An accessory 10-dB microphone attenuator extends this range to 150 dB. An impulse detector which meets IEC 651 is also built-in.

A significant feature of the 1988 allows you to capture and hold the peak or rms reading on the digital display without inhibiting successive readings on the analog meter. This lets you take ambient level readings immediately after the impact occurs without losing the peak reading. Also, in this mode it is not necessary to wait for the peak detector to decay before reading a lower peak. A press of the capture button resets the long decay time of the peak detector allowing you to read a lower peak immediately following the previous



measurement. This is especially useful when making measurements of forging hammers, metal stamping, and similar operations.

Easy, accurate reading The digital display allows quick, accurate, error-free reading with a resolution of 0.1 dB. Set the display mode to continuous and the digital display tracks the analog meter. Other operating modes allow you to "capture and hold" a reading on the digital display and to display the integration time limits and time remaining. You can automatically capture and hold the highest level measured during a measurement period or push a button to capture the level at a specific moment during the period. In any of these modes, the analog meter continues to track the ambient level. You will find the analog meter easy to read, too. It is calibrated linearly in 1-dB increments and the dB levels are clearly visible on the meter face.

Flexible power supplies The instrument's power system adds to its flexibility, too. As supplied, the 1988 operates from a 100-125 volt or 200-250 volt, 50-60 Hz power line. It can also draw power from its internal battery pack, which permits at least two hours of continuous operation. For battery operation up to 24 hours, an extended life battery and charger is available. The accessory auto-power cable can also be used to operate the 1988 from a standard 12-volt automobile battery.

Accessories available The 1988 and a calibrator will satisfy most measurement requirements. For those contemplating noise measurements where a remote microphone location is required, a calibrator, carrying case, tripod, and extension cable should be ordered to provide a complete system.

Specifications

Integration Characteristics: The 1988 measures and displays sound-pressure level (SPL or L_{eq}) or sound-exposure level (SEL) integrated over selectable times ranging from 1 sec to 24 hr. Integration can be timed manually or automatically. Two time ranges are available: 1 sec to 600 sec in 1-sec steps and 10 min to 24 hr in 1-min steps. A PAUSE feature permits exclusion of events not wanted in the integrated result. Short-time standard FAST and SLOW sound levels over range of more than 70 dB are included in Integrated result. Long-time integrated sound-pressure levels (L_{eq}) ranging from 25 to 150 dB and sound-exposure levels (SEL) ranging from 25 to 190 dB are displayed. The maximum detected level (Fast, Slow or Impulse) during integration period can be displayed at any time.

Standards: Meets the following (use 1987 or 1986 Sound-Level Callibrator):

ANSI Standard Specifications for Sound-Level Meters S1.4-1971, Type 1 (Precision).

IEC Standard 651-1979, Sound-Level Meters (Type 1).

ANSI Standard Specification for Octave, Half-Octave, and Third-Octave Band Filter Sets S1.11-1966, Type E, Class II.

IEC Recommendation Publication 225-1966, Octave, Half-Octave, and Third-Octave Band Filters for the Analysis of Sound and Vibration.

Reference Conditions: Reference conditions as required by IEC Standard 651-1979 are as follows:

Reference Direction of Incidence:

1988-9700—random

1988-9710—perpendicular to plane of diaphragm

Reference Sound Pressure Level: 94 dB

Reference Range: 100 dB full scale

Reference Frequency: 1 kHz

Level Range (Preamplifier GAIN set to x 1): 30 to 130 dB re $20 \mu\text{Pa}$ * (140 dB pk). May be extended to 140 dB rms (150 dB pk) using 10-dB microphone attenuator (1962-3210) supplied. Typical minimum measurable level, 32 dBA, lower in octave bands. Noise floor at least 5 dB below minimum measurable levels.

Frequency Weighting and Filters: A, B, and C weighting per reference standards. Flat response from 5 Hz to 20 kHz. Response is down -3 dB \pm 3 dB at 5 Hz and 20 kHz relative to 1-kHz level (electrical only, microphone not included). Ten octave-band filters ranging from 31.5 Hz to 16 kHz (center frequencies).

Detector Characteristics: Detector Response: Fast, Slow, Impulse (per IEC 651) and absolute peak (> 50- μ sec detector rise time) switch selectable. Precise rms detection for signals with crest factors up

to 20 dB at 120 dB,† (10 dB at 130 dB). Crest-factor capacity increases below full scale.

Detection of Overload and Underload: Signal peaks monitored at 2 critical points to provide positive indication of peak overload on panel LED. If, during integration, upper limit of detector range is exceeded for more than 0.1% of integration period, overload warning on digital display indicates that result may be in error. If integrated level is less than lower limit corresponding to 5 dB below bottom scale on panel meter, underload warning is given on digital display.

Display: ANALOG: 3-in panel meter graduated in 1-dB increments; four ranges: 30-80 dB, 50-100 dB, 70-120 dB, and 90-140 dB; displays continuous level (i.e., Fast, Slow, Impulse and Peak). DIGITAL: Display is 4-digit LED type with 0.1-dB resolution for level display; can display continuous level, maximum level, integrated sound level (L_{eq}) or sound-exposure level (SEL); display is updated once per second when integrating, 7 times per second in continuous mode.

Filters: Octave-band filters have attenuation of 3.5 ± 1 dB at nominal cutoff frequency, more than 18-dB attenuation at $\frac{1}{2}$ and 2 x center frequency, and more than 70-dB ultimate attenuation.

Microphone and Preamplifier: TYPE: $\frac{1}{2}$ -in. Electret-Condenser Microphone with Flat response to random (-9700) or perpendicular (-9710) incidence; response curve supplied. MOUNTING: Detachable preamplifier (1560-3410) that plugs into nose of instrument or can be removed with 10-ft cable (1933-0220) supplied or 60-ft cable (1933-9601) available. Preamplifier has selectable x 1 or x 10 gain, normally set for x 1. INPUT IMPEDANCE: Approximately 2 G Ω in parallel with < 6 pF. Switchable 200-V polarizing supply allows use with air-condenser microphones.

Outputs: AC OUTPUT: 0.4 V rms nominal, behind 5 k Ω , corresponding to full-scale deflection; any load permissible. DC OUTPUT: 3 V nominal, behind 30 k Ω , corresponding to full-scale meter deflection. Output is linear in dB at 60 mV/dB over 70-dB range (50-dB panel-meter display range plus 20-dB crest-factor allowance). Any load permissible. OUTPUT TO PRINTER: RS232C with TTL-logic levels (0-5 V), 25-pin-connector optional printer cable available for use with most TTL-compatible printers. Serial output rate at EIA standard 110 baud. Dwell time of 4 sec permits use with buffered-input printers. Elapsed integration time, selected integration level (L_{eq} or SEL) and maximum level during each integration period are printed.

*In the international system of units (SI) the unit of pressure is the pascal (Pa; 1 Pa = 1 N/m² = 10 dynes/cm² = 10⁻⁵ mbar. REF: "The International System of Units (SI)." U.S. Dept. of Commerce, National Bureau of Standards, NBS Special Publication 3320, SD Cal. No. C13-10-330/2, U.S. GPO, Washington, D.C. 20402.

† 10 dB higher when 10-dB microphone attenuator is used.

Calibration: FACTORY: Calibrated and fully tested to all specifications. Sensitivity measured in free field by comparison with laboratory-standard microphone that has calibration traceable to U.S. National Bureau of Standards. FIELD: GR 1987 or 1986 Sound-Level Callibrators are available for field calibration.

Environment: TEMPERATURE: -10 to +50°C operating, -40 to +60°C storage with batteries removed, +15°C during battery charging. HUMIDITY: 0-95% RH operating. MAGNETIC FIELD: 1-oersted (80 A/m) 60-Hz field causes 50-dB, C-weighted indication and negligible A-weighted indication, when meter is oriented for maximum sensitivity to field. Equivalent A-weighted response to 1-oersted 400-Hz field is approximately 55 dBA with meter oriented for maximum sensitivity to field. VIBRATION: When sound-level meter, with attached microphone, is vibrated at acceleration of 1 m/sec² (0.1G) in direction perpendicular to plane of microphone diaphragm, the indicated flat-weighted level does not exceed 80 dB in frequency range from 20 Hz to 1 kHz. Reference instrument that is not being vibrated indicates maximum level of 65 dB.

Supplied: Battery pack assembly; power pack and charger, microphone extension cable (10 ft); 10-dB microphone attenuator; calibration screwdriver; wrist strap; miniature phone plug (2); carrying pouch; microphone windscreen; power cable; support; instruction manual.

Available: Carrying case (includes space for calibrator, cable, tripod, miscellaneous accessories); battery pack assembly; microphone extension cables (10 ft, 20 ft, 60 ft); callibrators, 1986 and 1987; dummy microphones, 22 and 35 pF with BNC female input; tripod—will mount either 1982 or preamplifier; windscreen (package of 4); adapter cables for connection to outputs, all 3 ft (0.9 m) long; 1560-9619 Audiometer Calibration Accessory Kit; Vibration Integrator System; weatherproof enclosure adapter; extended-life battery and charger set; printer cable; auto power cable.

Power: May be operated from any of the following 4 sources of power. 1) 100-125 or 200-250 V line with power pack supplied. 2) Supplied AA-size rechargeable battery pack provides at least 2-hr continuous operation. Battery pack is recharged in about 4 hr from power pack. 3) Three AA-size alkaline (non-rechargeable) batteries in place of rechargeable AA battery pack. 4) Remote 12-V battery or any remote battery of sufficient capacity and voltage in range from 3.3 to 14 V. Cable and plug for connection are supplied.

Mechanical: 1988-9700, 1988-9710 DIMENSIONS (W x H x D): 3.9 x 20.2 x 2.3 in. (99 x 513 x 59 mm). WEIGHT: 3 lb (1.36 kg) net, 11 lb (5.0 kg) shipping.

1988-9610. Extended Life Battery and Charger Set.

An optional rechargeable battery, charger, and battery cable provide greater than 24-hour operation of the 1988-9700 or 1988-9710 instruments at locations remote from AC sources.

12.6 V, 5 aH rechargeable battery in simulated leather case, plus shoulder strap.

Mechanical: DIMENSIONS (W x H x D): 3.50 x 7.88 x 4.12 in. (89 x 202 x 105 mm). WEIGHT: 6.13 lb (2.77 kg).

Electrical Connection: Universal automotive cigar-lighter socket provided on one end of carrying case. Socket accepts cigar-lighter plug for charging the battery, or an adapter cable for supplying power to the instrument.

Protection: 5 ampere, type 3AG, normal blow fuse provided in in-line fuse-holder mounted within carrying case.

AC Charger: 12.6 V, 520 mA charger to charge the 12.6 V Battery Pack. Comes in plastic case and is switchable from 120 VAC to 220 VAC 50/60 Hz.

Charging Times:

| | | |
|------|--------|--------------|
| | 120V | 220V |
| 104V | 24 hrs | 198V 24hrs |
| 127V | 8 hrs | 242V 8 8 hrs |

Mechanical: DIMENSIONS (W x H x D): 2.4 x 5.1 x 2.2 in (61 x 130 x 56 mm). WEIGHT: 1.06 lb (0.48 kg).

Electrical Connections: INPUT: IEC Universal socket. OUTPUT: 6-ft (1.8-m) cord with automotive cigar-lighter plug.

Cable: Retractable cable with cigar-lighter plug at one end. Provides connection between 1988 and 12.6 V Battery Pack. Cable is extended from coiled length of approximately 1 ft (0.3 m) to 4 ft (1.2 m).

| Description | Catalog Number |
|---|----------------|
| Precision Integrating Sound-Level Meter and Analyzer (with random-incidence microphone)* | 1988-9700 |
| Precision Integrating Sound-Level Meter and Analyzer (with perpendicular-incidence response microphone)** | 1988-9710 |
| Printer Cable | 1988-9625 |
| Weatherproof Enclosure Adapter | 1988-9600 |
| Extended Life Battery and Charger Set | 1988-9610 |
| Auto Power Cable | 1988-9608 |
| Carrying Case (1988, 1986, tripod, etc.) | 1988-9630 |
| Carrying Case (1988, 1987, tripod, etc.) | 1988-9620 |
| 1988 Omnidirectional Sound-Level Calibrator | 1988-9700 |
| 1987 Minimal Sound-Level Calibrator | 1987-9700 |
| Dummy Microphone | 1988-9620 |
| Tripod | 1560-9530 |
| Windscreen (package of 4 for 1" microphone) | 1560-9521 |
| Windscreen (package of 4 for 1/2" microphone) | 1560-9522 |
| Microphone Extension Cable (10') | 1988-9600 |
| Microphone Extension Cable (20') | 1988-9614 |
| Microphone Extension Cable (60') | 1988-9601 |
| Vibration Integration System | 1988-9610 |
| 1" Ceramic Microphone | 1971-9601 |
| 1" Electret Condenser Microphone (random-incidence response) | 1961-9610 |
| 1" Electret Condenser Microphone (perpendicular-incidence response) | 1961-9611 |

*Conforms to ANSI S1.4 1971 Type 1 and IEC 651

**Conforms to IEC 651

1933 Precision Sound-Level Meter and Analyzer

- three instruments in one
precision sound-level meter
precision impulse sound-level meter
octave-band analyzer
- ideal for OSHA and a broad variety of noise measurements
- compact, lightweight, and fully portable
- virtually mistake-proof operation with:
OPTI-RANGE
easy-to-read meter display
extendible microphone mast
- can be used with low-cost dc recorders

A precision sound laboratory The 1933 is a precision measuring instrument that conforms to U.S. and international standards for a precision sound-level meter, octave-band analyzer, and impulse sound-level meter. An impact (true peak) measuring capability is also provided. The 1933 measures true rms values (there are no approximations) and automatically warns of invalid readings due to overloads. The complete instrument is in a package one-half the size and weight of conventional analyzers.

An easy-to-use instrument Set the upper knob to Weighting and the 1933 becomes a sound-level meter with a pushbutton choice of A, B, or C weighting or flat response from 5 Hz to 100 kHz. Fast and slow meter speeds are also pushbutton selected. Another button allows impulse testing, according to IEC Sound-Level Meter Standard 651, Type 1, or impact (peak sound-pressure level) testing often used for the measurement of industrial impact noise.

Conversion to an octave-band analyzer is equally simple; turn the knob to the desired octave band—there are 10 to choose from, with center frequencies from 31.5 Hz to 16 kHz.

Virtually mistake-proof measurement A single control is sufficient to set the meter range, even when the instrument is used as an octave-band analyzer. In other analyzers, two are required: An input range control to set the "all-pass" level and an analyzing range control to provide an on-scale meter indication after the desired octave filter has been selected. (Both are necessary to obtain the maximum analyzing range and maximum dynamic range.) But in the 1933 a unique automatic attenuator system is used (OPTI-RANGE). With this feature, you need only set a single range control for an on-scale indication. A second control is provided for situations where the automatic system may not be suitable, as with some measurements of transient signals.

The unusual meter scale also enhances the ease of operation. The meter spans a full 20-dB range, is graduated linearly over the entire range, and displays the attenuator setting on the meter face. These features reduce the number of range changes necessary and aid in rapid, error-free interpretation of the readings.

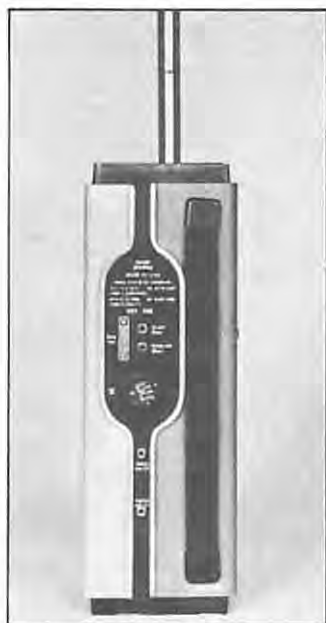

An expandable sound laboratory Often it is desirable to record field measurements for further analysis later in the laboratory. With the 1933 and its companion recorder, the 1935, it is easy to make accurate recordings of such measurements. In addition to an ac-signal output to drive one channel of the recorder, the 1933 also provides a level-range-code signal that is stored on a second channel of the recorder. On playback, the level-range setting used for the sound-level meter is indicated by a digital display on the panel of the tape recorder. Thus, the tape stores both data and absolute level information.

A dc output, proportional to the meter deflection (linear in dB), is provided to drive a low-cost dc recorder for hard-copy records of the level vs time. This output has a dynamic range of 40 dB plus an additional 20-dB crest-factor allowance.

Other features The microphones fit atop a telescoping 12-inch extension to reduce the effects of the instrument and operator on the sound field. There is rarely a need for extension cables and tripod. If these are necessary, however, a 20- or 60-foot cable and tripod are available. A 10-foot cable is supplied as standard equipment. Measurements are unaffected by the cables because the preamplifier in the 1933 is detachable and connects to the cable at the microphone end, to prevent signal loss.

A complete line of electret-condenser and ceramic microphones can be used with the 1933. Most users will want at least two: the one-half-inch random-incidence microphone, supplied, for smooth high-frequency response and nearly ideal directional characteristics, and the one-inch random-incidence microphone for measurements of very low sound levels. To simplify changing from one microphone to the other, two sensitivity presets are provided in the 1933. You can use two microphones alternately, in a series of measurements, without recalibration; merely turn the sensitivity switch to the position corresponding to the microphone being used.

For field or lab use The 1933 operates for up to 20 hours on self-contained batteries. A companion instrument, the 1940 Power Supply and Charger, allows the analyzer to be operated from the ac line and provides rechargeable batteries and a charging circuit.

Several versions to choose from Four versions of the basic instrument are offered, the difference among them being the number and types of microphones supplied. Versions with flat perpendicular-incidence response microphones are offered for the convenience of customers in those countries (particularly in Europe) where it has become customary to measure with this type of microphone. It should be noted that all versions offered comply with IEC 651.

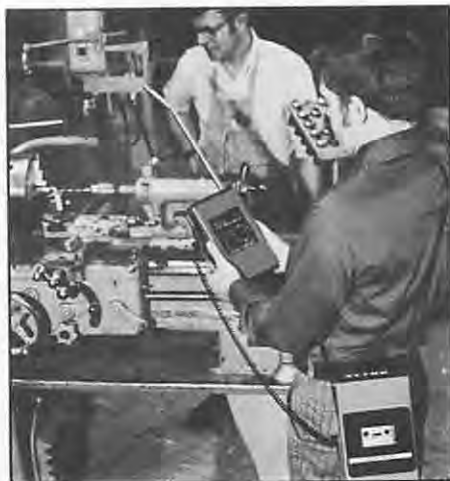

1933 Sound Analysis Systems

The 1933 Precision Sound-Level Meter and Analyzer is the heart of several systems available from GenRad to meet varying measurement and budget needs. All of the system instruments and accessories you require for different measurement situations have a special compartment in the system case and are readily at hand when you need them. Typical components in the systems available include: windscreens for outdoor measurements; a tripod for remote microphone mounting; an acoustic calibrator for on-the-spot calibration checks; earphones for aural monitoring; spare batteries; microphone extension cables; etc.

The 1933-9714 (ANSI and IEC conformance) or 1933-9715 (IEC conformance) are logical system selections. These systems are offered in a carrying case and include the following items: 1933 Precision Sound-Level Meter with 1/2-inch and 1-inch electret-condenser microphones, microphone attenuator, tool kit, 10-foot microphone extension cable, and batteries... 1562 Sound-Level Calibrator with battery and adaptors (but without carrying case)... 1/2-inch dummy microphone... 1/2-inch and 1-inch windscreen... earphone... small system carrying case... and instruction manuals.



Popular Accessories for the 1933

Vibration Integrator System

The 1933-9610 Vibration Integrator System expands the capabilities of the 1933 to include vibration measurements with readout of acceleration (L_a), velocity (L_v), and displacement (L_d). This added capability increases the versatility of the 1933 for noise-reduction work by permitting the measurement and analysis of structure-borne vibration. It also adds preventive maintenance to the 1933's functions since vibration analysis is often used to detect potential parts' failures in machinery and equipment.

The system consists of a vibration pickup (accelerometer) with a magnetic clamp and keeper, a vibration integrator that mounts on the 1933 preamplifier in place of a microphone, an 8-foot cable to connect the pickup of the integrator, a storage case, and a slide rule.

With the integrator, the 1933 reads directly in dB re the standard references for acceleration, velocity, and displacement. A special, easy-to-use slide rule is included in the system to permit simple readout directly in vibration units. This eliminates the need to refer to special conversion tables or to become involved in complex dB calculations.



Power Supply and Charger

The 1940 Power Supply and Charger allows the 1933 to be operated from an ac line, independent of their internal batteries. It is supplied with five rechargeable cells (to replace the ordinary C cells supplied in the analyzer) and a battery charger. There are no internal connections to make; the instrument simply plugs into the 1940 and is supported at a convenient angle for bench-top operation.



Calibrators

The 1986 or 1987 Sound-Level Calibrator is used to check the 1933 instrument calibration before and after each series of measurements. The 1986 Omnical has five output levels, from 74 to 114 dB, and six frequencies, from 125 to 4000 Hz. The 1987 Minical produces 1000 Hz at either 94 or 114 dB. Both calibrators accommodate 1/2-inch and 1-inch microphones.



Extension Cable and Tripod

The 1933-9601 60-foot Extension Cable and 1560-9590 Tripod are used in applications where the observer must be a considerable distance from the microphone and sound field.



Windscreens

Windscreens are used to reduce the effects of wind-generated noise and to protect the microphone diaphragm against contamination in oily, misty, or dusty environments. One-half inch and one-inch sizes are available.



Earphone

The 1935-9601 Earphone can be used with the 1933 to permit audible monitoring of the signal being measured. It is particularly useful for matching the annoying component of a noise source with an audible signal from a particular octave band.



Dummy Microphone

The 1560-9609 (35 pF) or 1560-9620 (22 pF) Dummy Microphone is used in place of the 1962 1/2-inch Electret-Condenser Microphone to determine instrument noise floor. A BNC input connector is provided to connect to a signal source.



Carrying Case

The 1933-9603 Carrying Case may be purchased separately to provide custom-fitted protection for the 1933 and its commonly used accessories.



SPECIFICATIONS

1933 PRECISION SOUND-LEVEL METER AND ANALYZER

Specifications meet ANSI S1.4-1971 for Type 1 (precision) Sound-Level Meters; IEC Sound-Level Meter Standard 651, Type 1; ANSI S1.11-1968 for Octave, Half-Octave, and Third-Octave Band Type 0 Class II Filter Sets; IEC 225-1968 for Octave, Half-Octave, and Third-Octave Band Filters for the Analysis of Sound and Vibrations; and IEC 651 for impulse measurement.

Level Range: 10 dB to 130 dB re 20 μ Pa with 1-in. microphone, 20 dB to 140 dB with 1/2-in. microphone. Typical minimum measurable level (noise floor 5 dB below minimum measurable level) with 1-in. microphone, 22 dBA; with 1/2-in. microphone, 31 dBA; lower in octave bands.

Frequency: 5 Hz to 100 kHz essentially flat response, 10 octave bands with center frequencies from 31.5 Hz to 16 kHz; plus A, B and C weighting.

Display: METER: 20-dB scale linearly marked in dB and lower, center, and upper values automatically indicated on scale. **RESPONSE:** Fast, slow, absolute peak, and impulse (per IEC 651), push-button selected. Precise rms detection for signals with ≤ 20 -dB crest factor at full scale, crest-factor capacity greater below full scale. **OVERLOAD:** Signal peaks monitored at 2 critical points to provide positive panel-lamp warning. **RANGING:** Automatic system (OPTI-RANGE) maximizes analyzing range and signal-to-noise ratio for each level range-control setting; manual control provides override. Increment between ranges, 10 dB.

Filters: **WEIGHTING:** A, B, C, and flat; pushbutton selected. **OCTAVE BANDS:** 10, manually selected, with 3.5 ± 1 -dB attenuation at nominal cutoff, >18 -dB attenuation at 1/2 and 2X center frequency, >70 -dB ultimate attenuation. **EXTERNAL FILTERS** can be substituted for internal weighting networks and octave-band filters; connect to 2 miniature phone jacks.

Input: 1/2-in. or 1-in. electret-condenser microphone mounted with detachable preamplifier on 12-in. extendible mast, or on 10-ft. extension cable supplied, or on 60-ft. cable available. Input can also be from tape recorder. **INPUT IMPEDANCE:** 1 G Ω // < 3 pF.

Output: **SIGNAL OUTPUT:** 0.632 V rms behind 600 Ω corresponding to full-scale meter deflection, any load permissible. **RANGE CODE:** Contact closure provides sound-level-meter range information to 1935 Cassette Data Recorder. **DETECTED OUTPUT:** 4.5 V dc behind 4.5 k Ω corresponding to full-scale meter deflection, output is linear in dB at 0.1 V/dB over 60-dB range (40-dB nominal range plus 20-dB crest-factor allowance), any load permissible.

Calibration: **FACTORY:** Fully tested and calibrated to all specifications; acoustical response and sensitivity are measured in a free field by comparison with a WE840 AA Laboratory Standard Microphone whose calibration is traceable to the U.S. National Bureau of Standards. **ON-SITE:** Built-in calibrator provides quick test of electrical circuits; GR1888- or 1987 Sound-Level Calibrator

is available for simple test of overall calibration, including microphones.

Environment: **TEMPERATURE:** -10 to + 50° C operating, -40 to + 60° C storage with batteries removed. **HUMIDITY:** 0 to 90% RH. **VIBRATION AND MICROPHONES:** Conform to applicable ANSI and IEC standards.

Magnetic Field: 1-Oersted (80 A/m) 60-Hz field causes 40 dB C-weighted indication when meter is oriented for maximum sensitivity to field using 1/2-in. microphone; 34 dB using 1-in. microphone.

Power: 4 alkaline energizer C cells supplied provide ≈ 20 -h operation; 1940 Power Supply and Charger allows line operation of 1933 and includes rechargeable batteries and charging source. Battery check provided on 1933.

Supplied: Microphone attenuator, tool kit, 10-ft. microphone extension cable, windscreen, batteries.

Mechanical (1933 Instrument) Small, rugged, hand-held case with standard 0.25-20 threaded hold for tripod mounting. **DIMENSIONS (wxhxd):** 6.19x3x3 in. (158x229x76 mm). **WEIGHT:** 5.5 lb (2.5 kg) net, 10 lb (4.6 kg) shipping.

(1933 Systems) **DIMENSIONS (wxhxd):** 1933-9714 and -9715: 19x14.5x6 in. (483x370x152 mm). **WEIGHT:** 1933-9714 and -9715: 15 lb (7 kg net), 17 lb (8 kg) shipping.

1940 POWER SUPPLY AND CHARGER

Power Source: 5 V for line operation of 1933, 6.5 V for line operation of 1935; 250 mA max.

Charging Source: 200 mA max for charging batteries in 1933 or 1935; automatically reduces to ≈ 30 -mA trickle charge when batteries are charged. Charging time 16 h.

Supplied: 5 rechargeable nickel-cadmium C cells to replace non-rechargeable batteries in 1933 or 1935.

Power: 100 to 125 or 200 to 250 V, 50 to 400 Hz, 11 W.

Mechanical: **DIMENSIONS (wxhxd):** 4.38x4.25x9.44 in. (111x108x240 mm). **WEIGHT:** 3.5 lb (1.5 kg) net, 5 lb (2.3 kg) shipping.

| Description | Catalog Number |
|--|----------------|
| 1933 Precision Sound-Level Meter and Analyzer | |
| With 1/2-in. and 1-in. microphones (random incidence)* | 1933-6700 |
| With 1/2-in. microphone only (random incidence)* | 1933-6701 |
| With 1/2-in. and 1-in. microphones (perpendicular incidence)** | 1933-6702 |
| With 1/2-in. microphone only (perpendicular incidence)** | 1933-6703 |
| SOUND ANALYSIS SYSTEMS | |
| 1933-6714 Sound Analysis System* | 1933-6714 |
| 1933-6715 Sound Analysis System** | 1933-6715 |
| ACCESSORIES AVAILABLE | |
| 1933 Vibration Integrator System | 1933-9610 |
| 1940 Power Supply and Charger (with rechargeable cells) | 1940-6701 |
| 1560-9619 Audiometer Calibration Accessory Kit | 1560-9619 |
| 1562-A Sound-Level Calibrator | 1562-6701 |
| 1986 Omnicol Sound-Level Calibrator | 1986-6700 |
| 1987 Minical Sound-Level Calibrator | 1987-6700 |
| 1560-P9 Dummy Microphone, 35 pF (used with 1982-9610, -9602) | 1560-9609 |
| Dummy Microphone, 22 pF (used with 1982-9610, -9611) | 1982-6280 |
| Electret-Condenser Microphones | |
| Flat random-incidence response, 1-in. | 1961-9610 |
| Flat perpendicular-incidence response, 1-in. | 1961-9611 |
| Flat random-incidence response, 1/2-in. | 1962-9610 |
| Flat perpendicular-incidence response, 1/2-in. | 1962-9611 |
| Ceramic Microphone Cartridge and Adaptor, 1-in. | 1971-9601 |
| Earphone | 1935-9601 |
| Tripod | 1560-6590 |
| Cables | |
| Microphone Extension Cable, 10 ft. | 1933-9600 |
| Microphone Extension Cable, 60 ft. | 1933-9601 |
| Microphone Extension Cable, 20 ft. | 1933-9614 |
| Miniature phone plug to 1933 microphone mast | 1933-9602 |
| Miniature phone plug to double banana plug | 1560-9677 |
| Miniature phone plug to standard phone plug | 1560-9678 |
| Miniature phone plug to BNC | 1560-9679 |
| Windscreens | |
| For 1/2-in. microphone, set of 4 | 1560-9622 |
| For 1-in. microphone, set of 4 | 1560-9621 |
| Carrying Case | 1933-9603 |
| Batteries | |
| Spare for 1933, uses 4 (non-rechargeable) | 8410-1500 |
| Spare for 1935, uses 5 (non-rechargeable) | 8410-1500 |
| Rechargeable, set of 5 | 1940-9500 |

*Conforms to ANSI S1.4-1971 Type 1 and IEC 651

**Conforms to IEC 651

1933-9610 Vibration Integrator System

- extends capabilities of 1933 Precision Sound-Level Meter and Analyzer
- direct readout in dB re standard references for:
 - acceleration
 - velocity
 - displacement
- handy slide rule gives metric and English vibration units

The 1933-9610 Vibration Integrator System extends the capabilities of the 1933 Precision Sound-Level Meter and Analyzer to include vibration measurements with readout of acceleration (L_a), velocity (L_v), and displacement (L_d). This added capability increases the versatility of the 1933 for noise-reduction work by permitting the measurement and analysis of structure-borne vibration as well as airborne noise. It also adds preventive maintenance to the 1933's functions since vibration analysis is often used to detect potential parts' failures in machinery and equipment.

The system consists of a vibration pickup (accelerometer) with a magnetic clamp and keeper, a vibration integrator that mounts on the 1933 preamplifier in place of a microphone, an 8-foot cable to connect the pickup to the integrator, a storage case, and a slide rule.

The 1933 reads directly in dB re the standard references for acceleration, velocity, and displacement. A special, easy-to-use slide rule is included in the system to permit simple readout directly in vibration units. This precludes the need to refer to special conversion tables or to become involved in complex dB calculations.

SPECIFICATIONS

Measurement Range: ACCELERATION: L_a in dB re 10^{-5} m/s²; (octave) 30 to 140 dB (3.16×10^{-4} to 100 m/s²), (flat) 46 to 140 dB (2×10^{-3} to 100 m/s²). VELOCITY: L_v in dB re 10^{-8} m/s; (octave) 60 to 150 dB (1×10^{-5} to 0.316 m/s), (flat) 76 to 150 dB (6.31×10^{-5} to 0.316 m/s). DISPLACEMENT: L_d in dB re 10^{-9} m; (octave) 50 to 150 dB (3.16×10^{-7} to 3.16×10^{-2} m), (flat) 66 to 150 dB (2×10^{-6} to 3.16×10^{-2} m).

System Environment: TEMPERATURE: -10 to +50° C operating; -40 to +70° C storage. HUMIDITY: 0-95% RH operating (45° C). VIBRATION: Withstand 0.030" pk-pk vibration 10 to 55 Hz.

Transducer Environment: (Endevco Model 2217E) VIBRATION: + 1000 pk g, sinusoidal, any direction. TEMPERATURE: -54 to +177° C. HUMIDITY: All welded hermetic seal.

Mechanical: (System in storage case). DIMENSIONS (wxhxd): 7.562x2.000x4.625 in. (190x51x117 mm). WEIGHT: 1.5 lb (0.7 kg) net, 3 lb (1.35 kg) shipping.

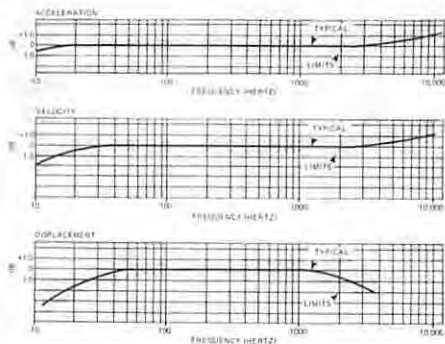

| Description | Catalog Number |
|---|----------------|
| 1933-9610 Vibration Integrator System (Also see 1560 Vibration Pickup System.) | 1933-9610 |

1982 Precision Sound-Level Meter and Analyzer

- a versatile, all-purpose instrument
 - precision sound-level meter
 - peak and impulse noise meter
 - octave-band analyzer
- ideal for OSHA and a broad variety of noise measurements
- digital and analog displays for error-free reading
- compact and lightweight (3 lb) for easy handling
- approved by MSHA and NIOSH

The 1982 Precision Sound-Level Meter and Analyzer combines measurement versatility with simplicity of operation to give you a practical, economical solution to a variety of noise measurements.

Now you can use a single instrument, without plug-in filters or other add-on accessories, to make A-, B-, or C-weighted sound-level measurements from 30 to 140 dB, octave-band analyses from 31.5 Hz to 16 kHz, and peak or impulse noise measurements.

The 1982 satisfies many noise-measurement requirements In a typical industrial facility, a company safety engineer, noise-control specialist or hired consultant may be required to make several types of noise measurements in a single day. With the GenRad 1982, the following measurements can be made without the need for any accessories or additional instrumentation.

1. A-weighted sound-level measurements to locate noise-hazard areas.
2. Peak and impulse measurements of short-duration noises caused by punch presses, metal-stamping equipment, riveting machines, etc.
3. Octave-band analyses required for:
 - a. Ear protector selection
 - b. Noise-barrier material selection
 - c. Noise-source identification for engineering-control programs
 - d. Audiometric booth-site surveys

Beyond its many uses in industrial safety and hearing-conservation programs, the 1982 has broad application in:

1. General noise measurements made by acoustic consultants.
2. Environmental noise programs at the federal, state, and community levels.

Alternatives to the single-instrument 1982 solution are separate instruments for each measurement function or sound-level meters with cumbersome plug-in or add-on accessories. The combined cost of separate instruments and accessories usually exceeds the cost of the 1982. Also, these alternatives require operating knowledge of different instruments and increase the chances for confusion and measurement errors.

The 1982 is easy to use With all of its versatility, the 1982 is extremely easy to use and does not require special technical training. Switching its operating mode from sound-level measurement to octave-band analysis, to peak or impulse measurement requires only the push of a slide switch or turn of a knob.



Precision sound-level measurement The 1982's conformance to ANSI Type 1 and IEC Sound-Level Meter Standard 651, Type 1, is your assurance of the most accurate performance offered in a sound-level meter. To make a measurement you simply switch to the weighting and meter response (fast or slow) you desire, switch on the meter and set the attenuator to the range that gives you an on-scale reading. Then you read the measured levels from either the digital display or analog meter.

Octave-band analysis The octave-band filters in the 1982 are the most accurate offered in a portable instrument. This assures a high degree of confidence in your octave-band measurements. In addition, the 1982 eliminates the often confusing two-attenuator system used in other instruments. The 1982 features a single attenuator which allows you to set the range desired, switch on the instrument, and read the measured level from either display. Should the range level be set too low, an overload light on the meter face alerts you to change to a higher level, thus avoiding incorrect readings.

Peak and impulse measurement The 1982's peak detector is the fastest available for measuring impact-or impulse-type noise. With a 50-microsecond rise time, the detector ensures reading the true peak of the signal, up to 140 dB.

An accessory 10-dB microphone attenuator extends this range to 150 dB. An impulse detector which meets IEC 651 is also built-in.

A significant feature of the 1982 allows you to capture and hold the peak or rms reading on the digital display without inhibiting successive readings on the analog meter. This lets you take ambient level readings immediately after the impact occurs without losing the peak reading. Also, in this mode it is not necessary to wait for the peak detector to decay before reading a lower level peak. A press of the capture button resets the long decay time of the peak detector allowing you to read a lower peak immediately following the previous measurement. This is especially useful when making measurements of forging hammers, metal stamping, and similar operations.

Easy, accurate reading The digital display allows quick, accurate, error-free reading with a resolution of 0.1 dB. Set the display mode to continuous and the digital display tracks the analog meter. Other operating modes allow you to "capture and hold" a reading on the digital display. You can automatically capture and hold the highest level measured during a measurement period or push a button to capture the level at a specific moment during the period. In either of these modes, the analog meter continues to track the ambient level.

You will find the analog meter easy to read, also. It is calibrated linearly in 1-dB increments and the dB levels are clearly visible on the meter face.

Accessories available The 1982 and a calibrator will satisfy most measurement requirements. For those contemplating noise measurements where a remote microphone location is required, a calibrator, carrying case, tripod and extension cable should be ordered to provide a complete system.

SPECIFICATIONS

Standards: Meets the following (use 1986 or 1987 Sound-Level Calibrator): ANSI Standard specifications for sound-level meters S1.4-1971, Type 1 (Precision); IEC Sound-Level Meter Standard 651, Type 1; ANSI standard specification for Octave, Half-octave, and Third-octave Band Filter Sets S1.11-1966, Type O, Class II; IEC Recommendation Publication 225-1966, Octave, Half-octave, and Third-octave Band Filters for the Analysis of Sounds and Vibrations.

Level Range: 30-130 dB re 20 μ Pa rms (140-dB PEAK). May be extended to 140-dB rms (150-dB PEAK) using 10-dB microphone attenuator (1962-3200) supplied. Typical minimum measurable level, 34 dBA; lower in octave bands. Noise floor at least 5 dB below minimum measurable levels.

Frequency Response: A, B, and C weighting; 10 octave-band filters ranging in center frequency from 31.5 Hz to 16 kHz; a FLAT response (+ 0.5, -3 dB from 10 Hz to 20 kHz).

Detector Characteristics: DETECTOR RESPONSE: Fast, Slow, Impulse (per IEC 651), and Absolute Peak (<50 μ s rise time), switch selected. Precise rms detection



A typical 1982 sound analysis system

for signals with crest factors as high as 20 dB to 120dB** (10 dB at 130 dB). OVERLOAD: Signal peaks monitored at two critical points to provide positive panel lamp warning of overload.

Display: ANALOG: Meter with 3-inch scale marked in 1-dB increments, four ranges: 30-80 dB, 50-100 dB, 70-120 dB, 90-140 dB. DIGITAL: 4-digit LED display with 0.1-dB resolution. Direct reading on all ranges. DIGITAL DISPLAY MODES: OFF, for minimum battery drain; CONTINUOUS, like meter except present reading can be "captured" by pushbutton; MAXIMUM, automatically holds highest level in measurement interval, until reset by pushbutton.

Microphone: TYPE: 1/2-inch Electret-Condenser Microphone with flat random (-9700) or perpendicular (-9710) incidence response. MOUNTING: Mounted with detachable preamplifier (1981-4000) that plugs into nose of instrument, or may be removed with 10-foot cable (1933-0220) supplied or 60-foot cable (1933-9601) available. INPUT IMPEDANCE: Approximately 2 $\text{M}\Omega$ / <3 pF.

Outputs: AC OUTPUT: 0.4 V rms nominal behind 5 K Ω corresponding to full-scale deflection, any load permissible. DC OUTPUT: 3V behind 30k Ω corresponding to full-scale meter deflection. Output is linear in dB at 60 mv/dB over 70-dB range (50-dB display range plus 20-dB crest-factor allowance). Any load permissible.

Calibration: FACTORY: Fully tested and calibrated to all specifications; acoustical response and sensitivity are measured in a free field by comparison with a Western Electric Type 640AA Laboratory Standard Microphone whose calibration is traceable to the U.S. National Bureau of Standards. FIELD: GR 1986 or 1987 Sound-Level Calibrators are available for making an overall pressure calibration.

Environment: TEMPERATURE: -10 to + 50° C operating, -40 to + 60° C storage with batteries removed, 15 to 50° C during battery charging. HUMIDITY: 0-90% RH operating.

Supplied: Battery pack assembly; battery charger; microphone extension cable (10-foot); 10-dB microphone

* U.S. Patent No. 3,681,618.

**10 dB higher when 10-dB microphone attenuator is used.

attenuator; calibration screwdriver; wrist strap; miniature phone plug(2); instruction manual; microphone wind-screen.

Available: Carrying Case (includes space for callibrator, cable, tripod, misc. access.); battery pack assembly; microphone extension cables (10-, 20-, and 60-foot); callibrators, 1986 and 1987; dummy microphones, 22 and 35 pF with BNC female input; tripod—will mount either 1982 or preamplifier; windscreen (package of 4); adaptor cables for connection to outputs, all 3 feet (0.9 m) long; 1560-9619 Audiometer Calibration Accessory Kit.

Power: Removable battery pack containing 3 AA-size nickel-cadmium rechargeable cells with charger interlock. Battery life between charges 3 to 4.5 hours depending on digital display usage. Battery charger supplied operates on 115/220 volts ac 50-60 Hz; full recharge accomplished in about 4 hours. Three AA-size alkaline cells (not rechargeable) may be used in place of the battery pack.

Mechanical: DIMENSIONS: (wxhxd): 3.9x16.8x2.3 in. (99x425x59 mm). WEIGHT: 3 lb (1.36 kg) net; 6 lb (2.8 kg) shipping.

| Description | Catalog Number |
|---|----------------|
| 1982 Precision Sound-Level Meter and Analyzer (supplied with 1/2-inch flat random incidence response electret condenser microphone).† | 1982-9700 |
| 1982 Precision Sound-Level Meter and Analyzer (supplied with 1/2-inch flat perpendicular incidence response electret condenser microphone).†† | 1982-9710 |
| 1986 Omnicast Sound-Level Calibrator | 1986-9700 |
| 1987 Omnicast Sound-Level Calibrator | 1987-9700 |
| 1560-9619 Audiometer Calibration Accessory Kit | 1560-9619 |
| Microphone Extension Cable, 10 ft. | 1933-9600 |
| Microphone Extension Cable, 60 ft. | 1933-9601 |
| Microphone Extension Cable, 20 ft. | 1933-9614 |
| Carrying Case, for 1982, 1987, tripod, and cable | 1982-9620 |
| Carrying Case, for 1986, tripod, and cable | 1982-9630 |
| Tripod | 1560-9530 |
| Windscreen (package of 4) | 1560-9522 |

† Conforms to ANSI S1.4 Type 1 and IEC 651

†† Conforms to IEC 651

1981-B Precision Sound-Level Meter

- digital and analog displays
- digital display can hold maximum level
- 30 to 120 dBA
- digital display can be "frozen" at any instant
- 50-dB analog scale has 1-dB linear calibration
- meets ANSI S1.4-1971 Type S1A and IEC 651
- approved by MSHA

The 1981-B combines both digital and analog displays in a single instrument. The dual-display capability of the 1981-B simplifies accurate data collection and the digital display gives you the advantage of more accurate (repeatable) readings, even for the most inexperienced users of sound-level meters.

The 1981-B spans 30 to 120 dBA in two switch-selectable 50-dB ranges.

Digital display The digital display on the 1981-B has three operating modes for maximum ease of use in a variety of measurement situations: CONTINUOUS, MAXIMUM HOLD, and CAPTURE DISPLAY.

In the CONTINUOUS mode the digital display tracks the reading on the analog meter. This mode is normally used for general-purpose noise surveys, giving the user the option of reading the measured level on either the digital or analog display.

The CAPTURE DISPLAY mode lets you capture and hold a reading on the digital display at any given moment by simply pushing a button. This mode is especially useful when you wish to measure the sound level of a specific event. You need only press the CAPTURE DISPLAY button when the event occurs and the sound level will be displayed and held constant. The level is held until you release the button so that you have adequate time to record the reading.

In the MAXIMUM HOLD mode of operation the digital display may be set to update and hold the maximum A-weighted sound level automatically during a measurement period. This eliminates meter watching and operator interpretation of the analog display when you wish to measure the maximum sound level encountered. This mode is particularly significant for vehicle passby measurements. It permits you to measure and hold the maximum level during the passby and, at the same time, to observe the sound level rise and fall on the analog meter to ascertain that a valid measurement has been made.

Two models To satisfy users who must comply with either or both American and International Standards, the 1981-B is available in two versions. One version is supplied with a flat random-incidence response GenRad Electret-Condenser Microphone. This model conforms to IEC 651, Type 1, and, when used with either a GenRad 1986 or 1987 Sound-Level Calibrator, it conforms to ANSI S1.4-1971 Type S1A.

The second version is supplied with a flat perpendicular-incidence response GenRad Electret-Condenser Microphone and conforms to IEC 651. This model is designed for use in countries where ISO Recommendations apply.

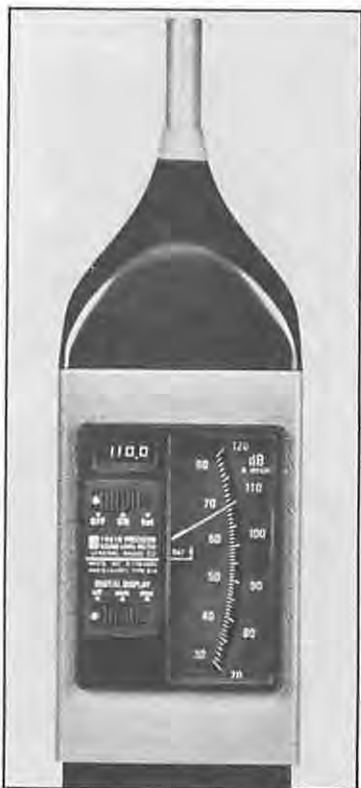

Accessories available The 1981-B and a calibrator will satisfy most measurement requirements. For those contemplating vehicle-noise measurements, a calibrator, carrying case, tripod and extension cable should be ordered to provide a complete system.

SPECIFICATIONS

Standards: Instruments with a GenRad 1/2-in. flat random-incidence response Electret-Condenser Microphone conform to IEC 651 and, when used with a GenRad Sound-Level Calibrator, to ANSI S1.4-1971 Type S1A.

Instruments with a GenRad 1/2-in. flat perpendicular-incidence response Electret-Condenser Microphone conform to IEC 651.

Measurement Range and Response Characteristics:

SOUND LEVEL RANGE: 30 to 120 dBA in two 50-dB switch-selectable ranges; 0-dB reference is 20 μ Pa. FREQUENCY RESPONSE: "A" weighting. DETECTOR* CHARACTERISTICS: Rms response. Crest-factor capacity, X5 at full scale. DYNAMICS: Fast and slow, switch selected.

Displays: ANALOG: Meter 3-in scale, 30 to 80 and 70 to 120 dBA; increments 1 db. DIGITAL READOUT: 4-digit with decimal point, "LED," 7-segment numerals; increments 0.1 dB. DIGITAL-DISPLAY MODES: OFF, for minimum battery drain; CONTINUOUS, like meter except present reading can be "captured" by push-button; MAXIMUM, automatically holds highest level in measurement interval, until reset by pushbutton.

Microphone and Terminals: MICROPHONE: GR 1/2-in. electret-condenser, 2 response types (see description). MICROPHONE CONNECTOR: Input impedance approx 1 G Ω , parallel 5 pF. AC OUTPUT: Weighted, 500 mV nominal full scale, behind 5 k Ω . DC OUTPUT: Approx 10 mV/dB, linear, 500 mV nominal full scale, behind 100 k Ω . Both outputs are short-circuit-proof; both receive miniature phone plugs (0.097 in., 2.5 mm dia.). INPUT: 1/2-in. electret-condenser microphone with flat response (random or perpendicular incidence); mounted with detachable pre-amplifier (1933-4000) that plugs into nose of instrument, or may be removed with accessory 10-, 20-, or 60-ft cable.

Calibration: FACTORY: The sound-level meter with microphone is fully tested and calibrated to all specifications; acoustical response and sensitivity are measured in a free field by comparison with a Western Electric 640AA Laboratory Standard Microphone whose calibration is traceable to the U.S. National Bureau of Standards. FIELD: GenRad 1986 or 1987 Sound-Level Calibrators are available for making an overall pressure calibration.

Environment: TEMPERATURE: -10 to +50° C operating, 15 to 50° C battery charging, -25 to +60° C storage with battery pack supplied. HUMIDITY: 0 to 90% RH, operating and storage.

Supplied: Wrist strap, battery pack, battery charger, screwdriver for calibration adjustment, miniature phone-plug connectors, windscreen, instruction manual.

Available: Calibrators, rechargeable battery pack, spare, microphone extension cables, tripod, carrying case (includes space for accessories), microphone windscreen (package of 4), tripod.

Power: Removable battery pack containing 3 AA-size nickel-cadmium rechargeable cells with charger interlock. Battery life between recharges, 5 to 10 hours depending on digital display usage. Battery charger (supplied) for 115/220 Vac 50-60 Hz operation; full recharge accomplished in about 4 hours. Instrument may be operated continuously from ac power by using charger; in this case battery pack is trickle-charged. Three AA-size primary cells (not rechargeable) may be used in place of the battery pack.

Mechanical: DIMENSIONS (wxhxd): 3.4 x 11 x 2.3 in. (87 x 292 x 59 mm). WEIGHT: 30 oz (0.8 kg) net, 5.5 lb. (2.5 kg) shipping.

*U.S. Patent 3,681,618.



A typical 1981-B Sound-Analysis System.

| Description | Catalog Number |
|--|----------------|
| 1981-B Precision Sound-Level Meter With 1/2-in. electret condenser microphone (random incidence)** | 1981-9750 |
| With 1/2-in. electret condenser microphone (perpendicular incidence)** | 1981-9751 |
| 1986 Omnical Sound-Level Meter | 1986-9700 |
| 1987 Minical Sound-Level Meter | 1987-9700 |
| Carrying Case, for 1981-B, 1987, tripod, and cable | 1981-9610 |
| Microphone Extension Cable, 10 ft. | 1933-9000 |
| Microphone Extension Cable, 60 ft. | 1933-9601 |
| Microphone Extension Cable, 20 ft. | 1933-9614 |
| Rechargeable Battery Pack, spare | 1981-2050 |
| Tripod | 1560-0590 |
| Windscreen (package of 4) | 1560-9522 |

*Conforms to ANSI S1.4 1971 Type S1A and IEC 651

**Conforms to IEC 651

1565-B Sound-Level Meter

- 40-to-140 dB range
- meets ANSI Type 2
- rugged ceramic microphone
- FET and integrated-circuit design combine performance with reliability
- convenient pocket proportions—small and light
- approved by MSHA and NIOSH

The best of both worlds The 1565-B is a full-fledged standard sound-level meter—it conforms to both national and international standards, meets all criteria necessary for the noise provisions of the Occupational Safety and Health Act, and includes most of the features usually found in larger, more cumbersome, and more expensive instruments. Yet the 1565-B fits in the palm of your hand and operates in severe environments for up to 50 hours on self-contained batteries. There are no line cords to bother with or microphone cords to trip over, and an imaginative combination of controls permits one-hand operation and rapid interpretation of the result—just aim and read.

The 1565-B is popular for rapid measurements of plant, traffic and community noise.

Performance and versatility built-in The 1565-B uses a rugged, yet laboratory-quality, ceramic microphone that can be checked easily, when necessary, by such standard calibration devices as the GenRad 1986 or 1987 Sound-Level Calibrator. An output jack is provided for use with headphones or recorders, and a lock is provided so the range control can be fixed in a single position. The instrument is housed in a tough plastic case, tapered at the microphone end to reduce the effects of case diffraction, and meets all ANSI requirements for a Type 2 general-purpose sound-level meter.

SPECIFICATIONS

Sound Level: 40 to 140 dB re 20 μ Pa.

Weighting: A, B, and C. Conforms to ANSI S1.4-1971 Type 2 and IEC 651.

Meter: Rms response with fast and slow speeds.

Input: MICROPHONE: Lead-zirconate-titanate ceramic. A 1560-P96 Adaptor converts input to 3-pin male A3 connector; for correct weighting, source impedance must be $380 \text{ pF} \pm 5\%$. **INPUT IMPEDANCE:** $13 \text{ M}\Omega // 15 \text{ pF}$.

Output: $\geq 1.2 \text{ V rms}$ behind 620Ω with meter at full scale; will drive 1521 or 1523 recorders, oscilloscopes, or low-impedance headphone. **HARMONIC DISTORTION:** $\leq 0.5\%$ (0.1% typical) from 32 Hz to 8 kHz, c-weighted with meter at full scale.

Calibration: Can be acoustically calibrated at 125, 250, 500, 1000, 2000, and 4000 Hz with 1986 Sound-Level Calibrator and at 1000 Hz with the 1987 Calibrator.

Environment: TEMPERATURE: -10 to +5° C operating; -40 to +60° C storage, with batteries removed. Coefficient of sensitivity $\approx +0.02 \text{ dB}/^\circ \text{C}$ at 6 dB below full-scale meter reading. **HUMIDITY:** 90% RH. **MAGNETIC FIELD:** 1-



Oersted (80 A/m) 50- or 60-Hz field causes $\approx 45 \text{ dB C}$ -weighted indication when meter is oriented to maximum sensitivity to field.

Supplied: Carrying pouch, miniature phone plug to connect to output, screwdriver for calibration adjust, windscreens, batteries.

Power: Two 9-V batteries (Burgess 2U6 or equal) supplied, provide ≈ 50 -h operation.

Mechanical: Shielded plastic case. **DIMENSIONS** (wxhxd): 3.63x6.5x2.09 in (92x165x53 mm); **WEIGHT:** 1 lb (0.5 kg) net, 3 lb (1.4 kg) shipping.

| Description | Catalog Number |
|---|----------------|
| 1565-B Sound-Level Meter | 1565-9702 |
| Windscreens reduce wind noise and protect against contaminants, pack of 4 | 1560-9521 |
| Battery, spare (2 required) | 8410-3200 |

Sound-Level Measurement Sets (Industrial Noise)

- measure noise levels
- calibrate "on the spot"

Convenient combination The GenRad sound-level measurement set is a practical buy for the person who needs to make sound-level measurements and wants to make his own periodic routine calibrations. Two versions of the set are offered, each containing a sound-level meter and a sound-level calibrator. The performance characteristics of each version are determined by the individual instruments in the set, as follows:

The 1565-B Sound-Level Meter meets ANSI Type 2 Standards.

The 1562-A Sound-Level Calibrator provides 5 frequencies, enabling you to test frequency response as well as to calibrate at a standard level. The 1987 Sound-Level Calibrator tests at 1000Hz, for calibration of level only.

Both instruments in each set are battery operated to provide truly portable sound-level measurements and calibration in a convenient, easily carried package. The carrying case has the added advantage of keeping both instruments together in a single package. The calibrator is therefore readily available for on-the-spot calibration of the sound-level meter.



SPECIFICATIONS

1565-9902 Sound-Level Measurement Set: 1565-B Sound-Level Meter, 1562-A Sound-Level Calibrator, carrying case, batteries, screwdriver for calibration adjust, miniature phone plug that connects to sound-level-meter output.

1565-9912 Sound-Level Measurement Set: 1565-B Sound-Level Meter, 1987 Sound-Level Calibrator, carrying case, batteries, screwdriver for calibration adjust, miniature phone plug that connects to sound-level-meter output.

Mechanical (any set): DIMENSIONS (wxhxd): 11.25x4.25x10 in. (286x108x254 mm). WEIGHT: 4.5 lb (2.1 kg) net, 12 lb (6kg) shipping.

For all other specifications, refer to the individual descriptions of the instruments in these sets.

| Description | Catalog Number |
|---------------------------------------|----------------|
| 1565-9902 Sound-Level Measurement Set | 1565-9902 |
| 1565-9912 Sound-Level Measurement Set | 1565-9912 |
| Carrying Case, for 1565-9902 | 1565-9600 |
| Carrying Case, for 1565-9912 | 1562-9600 |

1565-D Sound-Level Meter

- 30- to 130-dB range
- meets ANSI and IEC Type 2
- rugged ceramic microphone
- FET and integrated-circuit design combine performance with reliability
- convenient pocket proportions—small, light and easy to use

The best of both worlds The 1565-D is a full-fledged standard sound-level meter—it conforms to both national and international standards, and includes most of the features usually found in larger, more cumbersome, and more expensive instruments. Yet the 1565-D fits in the palm of your hand and operates in severe environments for up to 50 hours on self-contained batteries. There are no line cords to bother with or microphone cords to trip over, and an imaginative combination of controls permits one-hand operation and rapid interpretation of the result—just aim and read.

Performance and versatility built-in The 1565-D uses a rugged, yet laboratory-quality, ceramic microphone that can be checked easily, when necessary, by such standard calibration devices as the GR 1986 or 1987 Sound-Level Calibrators. An output jack is provided for use with headphones or recorders, and a lock is provided so the range control can be fixed in a single position. The instrument is housed in a tough plastic case, tapered at the microphone end to reduce the effects of case diffraction, and meets all ANSI and IEC requirements for a Type 2 general-purpose sound-level meter.

SPECIFICATIONS

Sound Level: 30 to 130 dB re 20 μ Pa.

Weighting: A, B, and C. Conforms to ANSI S1.4-1971, IEC Sound-Level Meter Standard 651, Type 2.

Meter: RMS response with fast and slow speeds.

Input: MICROPHONE: Lead-zirconate-titanate ceramic. A 1560-P96 Adaptor converts input to 3-pin male A3 connector; for correct weighting, source impedance must be 380 pF \pm 5%. INPUT IMPEDANCE: \approx 13 M Ω / 15 pF.

Output: \geq 1.2 V rms behind 6.2 k Ω with meter at full scale; will drive 1521 or 1523 recorders, oscilloscopes, or low-impedance headphone. HARMONIC DISTORTION: \leq 0.5% (0.1% typical) from 32 Hz to 8 kHz, C-weighted with meter at full scale.

Calibration: Can be acoustically calibrated at 125, 250, 500, 1000, 2000, and 4000 Hz with the GR 1986 Sound-Level Calibrator and at 1000 Hz with the 1987 Calibrator.

Environment: TEMPERATURE: -10 to +50° C operating; -40 to +60° C storage, with batteries removed. Coefficient of sensitivity \approx +0.02 dB / ° C at 6 dB below full-scale meter reading. HUMIDITY: 90% RH. MAGNETIC FIELD: 1-Oersted (80 A/m) 50- or 60-Hz field causes \approx 45 dB C-weighted indication when meter is oriented to maximum sensitivity to field.



Supplied: Carrying pouch, miniature phone plug to connect to output, screwdriver for calibration adjust, batteries.

Power: Two 9-V batteries (Burgess 2U6 or equal) supplied, provide \approx 50-h operation.

Mechanical: Shielded plastic case. DIMENSIONS (wxhxd): 3.63x6.5x2.09 in. (92x165x53 mm); WEIGHT: 1 lb (0.5 kg) net, 3 lb (1.4 kg) shipping.

| Description | Catalog Number |
|---|----------------|
| 1565-D Sound-Level Meter | 1565-9704 |
| Windscreens reduce wind noise and protect against contaminants, pack of 4 | 1560-9521 |
| Battery, spare (2 required) | 8410-3200 |

Sound-Level Measurement Set (Community Noise)

Whether or not your community has enacted noise ordinances, GenRad's 1565-9910 Sound-Level Measurement Set will be a valuable asset. The set consists of a 1565-D Sound-Level Meter for making noise measurements from 30 to 130 dB, a 1987 Sound-Level Calibrator for routine calibration of the meter, a windscreen, and a rugged carrying/storage case.

The 1565-D Sound Level Meter has been specifically designed for community noise measurements. It meets the American National Standards Institute (ANSI) Type 2 Specifications, which detail the required instrument performance. The 1565-D is easy to operate and requires no prior knowledge of acoustics.

As is true with all measuring instruments, routine calibration is a must for measurements that have legal significance. The GenRad 1987 Sound-Level Calibrator is included in this set to permit on-the-spot calibration of your sound-level meter. Routine calibration is simple and takes only a few seconds.

SPECIFICATIONS

1565-9910 Sound-Level Measurement Set: Consists of 1565-D Sound-Level Meter, 1987 Sound-Level Calibrator, windscreen, carrying case, batteries, screwdriver for calibration adjust, and miniature phone plug that connects to sound-level-meter output.

Mechanical: DIMENSIONS (wxhxd): 11.25x4.25x10 in. (286x108x254 mm). WEIGHT: 4.5 lb (2.1 kg) net, 12 lb (6 kg) shipping.



| Description | Catalog Number |
|---------------------------------------|----------------|
| 1565-9910 Sound-Level Measurement Set | 1565-9910 |
| Carrying Case, for 1565-D and 1987 | 1565-9600 |

1983 Sound-Level Meter

- ideal for OSHA and vehicle-noise measurements
- approved by MSHA and NIOSH
- meets ANSI S1.4-1971 Type S2A
- one range, 70 to 120 dBA
- no range switching; turn on and read
- easy-to-read scale calibrated in 1-dB increments

This GenRad sound-level meter is specially designed to satisfy the need for a low-cost, easy-to-use sound-level meter. It meets ANSI S1.4-1971 Type S2A as required for OSHA noise measurements.

Utmost simplicity The GenRad 1983 is the latest in design and operating simplicity. Its tapered case minimizes reflections which could cause erroneous readings. Readings are always in dBA since the A weighting is built-in. A single range, 70 to 120 dBA, eliminates the need to make any special settings or adjustments. To make a measurement, you simply push the ON/OFF switch, orient the meter to the proper position, and read the scale. The big meter scale is extremely easy to read because of its clearly marked 1-dB increments over the entire 50-dB range. The 1983 is set to operate in the SLOW meter-response mode but a simple internal adjustment lets you switch to FAST meter response, normally, used for vehicle-noise measurements.

Design features For reliable operation in tough industrial environments, a rugged ceramic microphone and solid-state circuitry are used to ensure accurate measurements in temperature extremes from -10 to + 50° C and in environments of up to 95% relative humidity. The low current requirement of the 1983's circuitry permits continuous operation on a single 9-volt transistor-radio-type battery for up to 60 hours and a dc output lets you operate low-cost dc recorders and other accessories.

The 1983 is supplied with a removable microphone for remote measurements with optional extension cables. This permits the microphone to be located at the measurement point and the observer with the meter to be located away from the sound field to eliminate interference with the measurement.

Calibration Good measurement practice dictates periodic calibration of your sound-level meter. Many laws, including current OSHA regulations, require calibration of measuring instruments everyday that measurements are made. The GenRad 1987 Sound-Level Calibrator lets you check the calibration of the 1983 and other acoustic instruments in a matter of seconds. It has an acoustic output of 1000 Hz at 94 and 114 dB and meets the accuracy requirements of OSHA regulations.

Accessories available When the use of a tripod or remote microphone is not required, the 1983 and a calibrator will satisfy most measurement requirements. For those contemplating vehicle-noise measurements, a calibrator, carrying case, tripod and extension cable should be ordered to provide a complete system.

Vehicle-noise measurement sets Vehicle noise is the largest component of environmental noise. As a result, more vehicle noise ordinances are being written and



enforced at all levels of government. Some laws are aimed specifically at muffler noise; others are for pass-by noise. GenRad offers you the flexibility of choosing the instruments and accessories that will best match your vehicle-noise application.

These noise measurement sets have been specifically designed to satisfy vehicle-noise measurement requirements specified by legislation at the federal, state, and local levels. The sets feature simplicity of operation and calibration so that reliable measurements can be made by law enforcement officers and others who have not had prior experience in acoustic measurements.

Each set should include a 1983 Sound-Level Meter (supplied with remote microphone), a 1987 Calibrator, an extension cable, a carrying case, and a tripod. This

permits the microphone to be located at the measurement point and the observer with the meter to be located away from the sound field, to eliminate interference with the measurement.

Special set-up for muffler measurements A special tripod set-up is featured for low-to-the ground muffler-noise measurements. With the microphone positioned near the muffler, the observer can sit at the vehicle's controls with the sound-level meter and regulate the engine's rpm while observing the meter readings.

A windscreen is supplied to negate the effects of moderate breezes on the measurement and to protect the microphone from dust, dirt and other airborne contaminants. It is good practice to check calibration at the beginning and end of each day that measurements are made, and on-the-spot calibration checks of the sound-level meter can be made in a matter of seconds with a GenRad 1987 Sound-Level Calibrator.

SPECIFICATIONS

Sound Level: 70 to 120 dBA re 20 μ Pa.

Weighting: A; conforms to ANSI S1.4-1971 Type S2A and IEC 651, Type 2.

Meter: Rms response, slow. Internal connection allows selection of fast response.

Output: 0.25 V behind 100 k Ω at full scale (120 dB), will drive recorders or other accessories.

Calibration: Can be pressure calibrated with GenRad 1986 or GenRad 1987 Sound-Level Calibrator.

Environment: TEMPERATURE: -10 to + 50° C operating; -40 to + 60° C storage, with batteries removed. HUMIDITY: 0 to 95% RH. MAGNETIC FIELD: Reads less than 70 dB when placed in a 50- to 60-Hz magnetic field of 25 oersteds.

Supplied: Carrying pouch, miniature phone plug to connect to output, screwdriver for calibration adjust, battery.

Available: Calibrators, microphone extension cables, battery (spare), tripod, carrying case, windscreen (package of 4).

Power: One 9-V battery (Burgess 2U6 or equal) supplied, provides 60-h operation.

Mechanical: (Meter): Shielded plastic case. DIMENSIONS: (wtxhxd): 3.5x7.95x1.87 in. (89x202x48 mm); WEIGHT: 12 oz (0.34 kg) net, 3 lb (1.4 kg) shipping.



| Description | Catalog Number |
|---|----------------|
| 1983 Sound-Level Meter | 1983-9730 |
| 1986 Omnidirectional Sound-Level Calibrator | 1986-9700 |
| 1987 Minimal Sound-Level Calibrator | 1987-9700 |
| Microphone Extension Cable, 10 ft. | 1933-9800 |
| Microphone Extension Cable, 60 ft. | 1933-9801 |
| Microphone Extension Cable, 20 ft. | 1933-9814 |
| Carrying Case (for 1983 and 1987) | 1983-9820 |
| Battery, spare for meter (1 required) | 8410-3200 |
| Battery, spare for calibrator (1 required) | 8410-3400 |
| Windscreens (package of 4) | 1560-9522 |
| Tripod | 1560-9590 |
| Vehicle-noise measurement set, pass-by muffler or stationary run-up (order components separately) | |
| 1983 Sound-Level Meter | 1983-9730 |
| 1987 Sound-Level Calibrator | 1987-9700 |
| Microphone Extension Cable, 10 ft. | 1933-9800 |
| Microphone Extension Cable, 20 ft. (recommended for muffler noise set) | 1933-9814 |
| Microphone Extension Cable, 60 ft. | 1933-9801 |
| Carrying Case (for 1983 and 1987) | 1983-9820 |
| Tripod | 1560-9590 |

1954 Noise Dosimeter

...Consists of Monitor and Indicator as follows

1954 Noise-Exposure Monitor

- user adjustable threshold and criterion levels
- small, shirt-pocket size
- light weight, 10 oz
- tamper-proof
- built-in and remote mike
- conforms to ANSI S1.25-1978 and applicable portions of IEC Sound-Level Meter Standard 651

1954 Indicator

- only one required for any number of monitors
- built-in sound-level calibrator checks complete system including microphone
- readout available only to authorized persons
- all electronic, including bright light-emitting-diode display—no moving parts
- powered by monitor battery

Why use a noise dosimeter? The 1954 Noise dosimeter is designed to save you time and money in the measurement of noise for computation of personal noise dose. In industrial environments where noise levels vary constantly, noise-dose measurements are the easiest method of determining both the risk of hearing damage and compliance with the law. Computing noise dose in virtually every industrial environment would necessitate tedious day-long measurements with a sound-level meter and timing with a stop watch. This is necessary because noise dose is computed by the formula:

$$D = \frac{C_1}{T_1} + \frac{C_2}{T_2} + \dots + \frac{C_n}{T_n}$$

where D is noise dose, C is the actual duration (in hours) at a given steady noise level, and T is the noise exposure limit (in hours) from the table below.

| Sound level [dBA] | 90 | 95 | 100 | 105 | 110 | 115 |
|------------------------|----|----|-----|-----|-----|------|
| Time permitted [hours] | 8 | 4 | 2 | 1 | 0.5 | 0.25 |

Computing noise dose with a sound-level meter is generally impractical and expensive. A noise dosimeter performs the measuring, timing, and computing automatically. You need only read the computed answer at the end of the measurement period.

Unsurpassed for noise-dose measurements The primary function of the 1954 is automatic monitoring of sound levels and computing personal noise dose based on current OSHA noise limits and other established standards. Should the limits change you can re-adjust the 1954 yourself, quickly and easily. A screwdriver is all you will need to adjust the exchange rate, criterion level, threshold level, and maximum allowable level. There is no expense or lost measurement time since the 1954 need not be returned to the factory or a service center for adjustment.

Noise-dose measurements are simple and automatic At the start of the workday or other monitoring period, your noise-program supervisor turns on the small wearable



monitor by means of a concealed on-off switch. Operating controls are concealed to discourage tampering. The monitor is then calibrated (about 10 seconds), clipped in a pocket or on a belt or waistband, and the tiny microphone is positioned at the ear, on a collar, or wherever you desire. Noise levels to which the wearer is exposed are then monitored continually throughout the workday, and noise dose is computed automatically without any effort or operating requirements on the part of the employee or noise program supervisor.

Reading the noise dose is quick and easy At the end of the measurement period the monitor is plugged into the 1954 Indicator. You simply push a button to retrieve the computed noise dose which is then displayed on a 4-digit electronic display. The number is the actual percentage of the OSHA criterion limit. A display of 085.0, for example, means that the total noise dose is 85% of the OSHA maximum, a safe level. A reading of 145.0 indicates that the noise dose exceeds OSHA limits by 45% and that some corrective action is required.

Since the OSHA maximum allowable noise level is 115 dBA, the 1954 is designed to indicate if 115 dBA was exceeded during the measurement. This is shown by a lamp on the indicator that lights during readout of the noise dose.

Calibration takes less than 10 seconds The 1954 Indicator features a built-in calibrator that lets you check the complete instrument from the microphone to the display at the push of a button. Unlike other dosimeters, the 1954 can be continuously adjusted during the calibration period, with the screwdriver supplied. An opening in the monitor case provides access to the calibration adjustment so that the case need not be taken apart. The procedure is as simple as calibrating a sound-level meter.

A complete calibration check takes less than 10 seconds and is recommended at the beginning and end of each measurement period. A separate calibrator is not required, as with other systems.

Work area noise-exposure measurements You can use the 1954 to measure the noise dose of specific work areas. These measurements are also completely automatic. The procedure is simple. Just switch on the monitor, plug it into the indicator, position the microphone on the microphone extension, and place the 1954 on a table or set it up on a tripod in the area to be measured. At any time during the measurement period, you can check the computed noise-dose answer by pushing the "display" button. This does not erase the memory and allows you to continue the measurement for the full period.

Equivalent sound-level measurements Noise-survey measurements, usually made with a sound-level meter, are another function of the 1954. Again you plug the monitor into the indicator and position the microphone on the removable extension. Sound-level measurements are made by pressing the "Reset" button. In a few seconds, you'll get a reading on the digital display that you can convert to dBA by simply reading the conversion chart printed on the monitor face.

Users concerned with community-noise measurements can select a 3-dB exchange rate monitor which allows "L_{eq}" measurements prescribed in many community-noise ordinances.

User adjustable Obsolescence due to changes in OSHA or other noise criteria is not a factor when you buy the GenRad 1954. Provision is made for you, the user, to readjust the 1954 to meet most changes when they occur. And all you need is a screwdriver. There is no service charge to be concerned with, and no time lost in returning your instrument to the factory or a service center.

The versatility of the 1954 precludes the need to buy a separate sound-level meter and/or area noise monitor for many users. And if community-noise measurements become a factor in the future, an additional monitor is all you need for L_{eq} measurements.



Push the "Display" button for a clear, digital indication of the computed dose [actual percentage of OSHA maximum], and to see if 115 dBA was exceeded. This does not reset monitor memory to zero.



Press "Display" and "Reset" buttons simultaneously to reset monitor to zero for start of a new measurement period.



Microphone is secured in calibration cavity by spring-loaded clip. Press the "Calibrate" button and read prescribed level in just under ten seconds. Continuous adjustment, if necessary, can be made quickly with screwdriver supplied.

SPECIFICATIONS

NOISE-EXPOSURE MONITOR: (5-dB Exchange Rate) 1954-9710

The 1954-9710 Noise-Exposure Monitor integrates the noise in conformance with OSHA Regulations (90-dB Threshold, 5-dB Exchange rate). The integrated level is stored in a low-power MOS-type counter which is permanently connected to the battery. The Monitor can be converted in the field by changing plug-in jumpers to provide an 80, 85, or 90 dB threshold and an exchange rate of either 3 or 5 db.

Noise Level Exposure: Maximum permissible exposure of 100% in accordance with OSHA is accumulated for the following combinations: (Range control set to 80-130).
Sound Level dBA **Exposure (hours per day)**

| | |
|-----|------|
| 90 | 8 |
| 95 | 4 |
| 100 | 2 |
| 105 | 1 |
| 110 | 0.5 |
| 115 | 0.25 |

Sound level is interpolated between the above points. The integrator cuts off sharply below 90 dBA.

Level Range: Selectable by switch on top of Monitor.

| Sound-Level Range (dB) | Threshold Level (dBA) | Peak Level W/O Overload (dB) | Allowable Level Exceeded Indication (dBA) |
|------------------------|-----------------------|------------------------------|---|
| 80-130 | 90 | 143 | 115 |
| 60-110 | 70 | 123 | 95 |
| 40- 90 | 50 | 103 | 75 |

Weighting: "A" in accordance with ANSI Standard S1.25-1978 and IEC Sound-Level Meter Standard 651.

Accuracy: At 116.5 dB, 1kHz, 23° C, 760 mm Hg; ± 7% of indicated reading (± 0.5 dB). Temperature coefficient of sensitivity typically + 0.03 dB/°C. Unit calibrated for a reading at the mid-point of the allowable calibration range using the built-in calibrator.

Linearity: Within selected sound-level range: ± 1 dB (measured at 1 kHz with reference to a level 35 dB above threshold).

Standards: Satisfies ANSI S1.25-1978 for Personal Noise Dosimeters and applicable sections of IEC 651 for sound-level meters.

Detector*: True rms response with SLOW dynamic characteristics in accordance with ANSI S1.25-1978 and IEC 651. Crest-factor capacity at 115 dB is greater than 25 dB.

Allowable Level Exceeded: If on the 80-130 dB sound-level range, 115-dB sound level is exceeded, this information is stored in the monitor unit and read out on the indicator. On the 60-110 dB and 40-90 dB ranges, an indication is given if level during monitoring period ever exceeds 90 and 75 dB respectively.

*U.S. Patent Number 368,168

Microphone: Ceramic type. Remote from monitor (32" extension cable).

Environment: TEMPERATURE: -10 to + 50° C operating, -40 to + 60° C storage with batteries removed. HUMIDITY: 0 to 90% RH at 40° C.

Effect of Magnetic Field: On the 80-130 dB range, the monitor will accumulate equivalent to a level less than 80 dB when placed in a magnetic field of 100 oersteds at 50 or 60 Hz, or less than 40 dB in a 6-oersted magnetic field at 50 or 60 Hz on any range.

Supplied: Three earloops, one windscreens set (contains 2 windscreens assemblies), one 9-V alkaline battery, three battery sleeves, shoulder microphone holder.

Available: 1954-9610 Windscreens Set (contains 4 windscreens assemblies), 1954-9630 Microphone Assembly (includes 32-inch cable and plug), 8410-3400 9-V alkaline battery, Mallory Type MN 1604 or equivalent, 1954-9660 Shoulder Microphone Holder-5 pack.

Power: One 9-V alkaline battery supplied, provides 40 hours of typical operation. MOS-counter and latch-storing data are permanently connected to the battery and can store accumulated noise dose and maximum level exceeded data for three months (monitor alone), one month with monitor plugged into indicator.

Mechanical: Shielded microphone and metal case. DIMENSIONS (wxhxd): 2.5x6.0x1.2 in (63x153x31 mm). WEIGHT: 10.3 oz (0.29 kg) net.

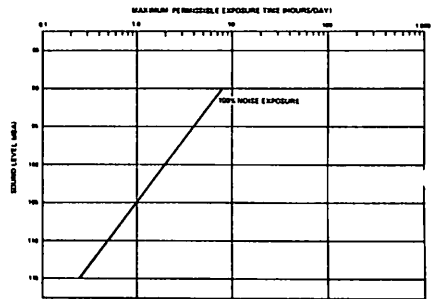

NOISE-EXPOSURE MONITOR (3-dB Exchange Rate) 1954-9730

Specifications same as 1954-9710 except those below.

The 1954-9730 Noise-Exposure Monitor integrates noise in accordance with ISO 1999 (August 1975). The integrated level is stored in a low-power, MOS-type counter which is permanently connected to the battery. The monitor can be converted in the field by changing plug-in jumpers to provide an 80, 85, or 90 dB threshold and an exchange rate of 3 or 5 dB.

Noise Level Exposure: The noise exposure index number displayed doubles when exposed time is doubled or when exposure level is increased by 3 dB. A level change of 3 dB can be traded for a factor of two in time. The monitor operates linearly over a dynamic range of 60 dB above the threshold level selected. This 60-dB range includes an allowance of 13 dB for signal crest factor. Exposure Index numbers from 00.00 to 9999 are stored for display on the indicator.

Level Ranges: Selectable by switch on top of monitor.

| Sound-Level Range (dB) | Threshold Level (dBA) | Peak Level W/O Overload (dB) | Allowable Level Exceeded Indication (dBA) |
|------------------------|-----------------------|------------------------------|---|
| 80-130 | 80 | 143 | 130 |
| 60-110 | 60 | 123 | 110 |
| 40- 90 | 40 | 103 | 90 |

Weighting: "A" in accordance with ANSI Standard S1.25-1978 and IEC 651 for Type 2 Sound-Level Meters.

Accuracy: At 116.5 dB, 1 kHz, 23° C, 760 mm Hg atmospheric pressure $\pm 11\%$ of indicated reading ($\approx \pm 0.5$ dB). Temperature coefficient of sensitivity typically $+ 0.03$ dB/° C. (Unit calibrated for a reading at the midpoint of the allowable calibration range using the built-in calibrator.)

Standards: Satisfies ANSI S1.25-1978 for Personal Noise Dosimeters ISO 1999 (1975), and applicable portions of IEC Sound-Level Meter Standard 651 for Type 2 Sound-Level Meters.

Detector*: True rms response with SLOW dynamic characteristics in accordance with IEC 651 and ANSI Standard S1.25-1978. Crest-factor capacity at high end of range is 13 dB.

Allowable Level Exceeded: If the upper limit of the selected range is exceeded (i.e., 130, 110, or 90 dB), this information is stored in the monitor unit and read out on the indicator.

NOISE-EXPOSURE MONITOR (4-dB Exchange Rate) 1954-8780

Specifications same as 1954-9710 except those below.

The 1954-9780 Noise-Exposure Monitor integrates noise in accordance with AFR 161-35. The integrated level is stored in a low-power, MOS-type counter which is permanently connected to the battery. The monitor can be converted in the field by changing plug-in jumpers to provide an 80, 85, or 90 dB threshold and an exchange rate of either 3, 4, or 5 dB.

Noise Level Exposure: The percentage exposure displayed doubles when exposed time is doubled or when exposure level is increased by 4 dB. A level change of 4 dB can be traded for a factor of two in time. Percentage exposure numbers from 00.00 to 9999 are stored for display on the indicator.

Level Ranges: Selectable by switch on top of monitor.

| Sound-Level Range (dB) | Threshold Level (dBA) | Peak Level W/O Overload (dB) | Allowable Level Exceeded Indication (dBA) |
|------------------------|-----------------------|------------------------------|---|
| 80-130 | 80 | 137 | 115 |
| 60-110 | 60 | 117 | 95 |
| 40- 90 | 40 | 97 | 75 |

Accuracy: At 116.5 dB, 1 kHz, 23° C, 760 mm Hg atmospheric pressure; $\pm 9\%$ of indicated reading ($\approx \pm 0.5$ dB). Temperature coefficient of sensitivity typically $+ 0.03$ dB/° C. (Unit calibrated for a reading at the midpoint of the allowable calibration range using the built-in calibrator.)

Standards: Satisfies ANSI S1.25-1978 for Personal Noise Dosimeters, ISO 1999 (1975) and applicable portions of IEC Sound-Level Meter Standard 651 for Sound-Level Meters.

Detector*: True rms response with SLOW dynamic characteristics in accordance with IEC 651 and ANSI Standard S1.25-1978.

Allowable Level Exceeded: If, on the 80-130 sound-level range, 115-dB sound level is exceeded, this information is stored in the monitor unit and read out on the indicator. On the 60-110 dB and 40-90 dB ranges, an indication is given if the level (during the monitoring period) exceeds 90 and 75 dB respectively.

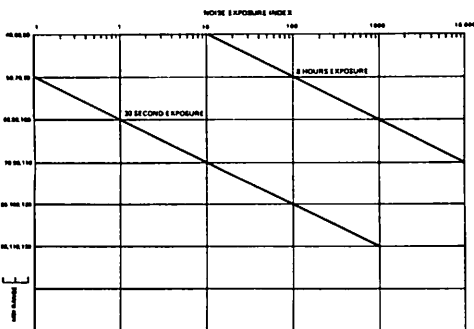

*U.S. Patent Number 366,166

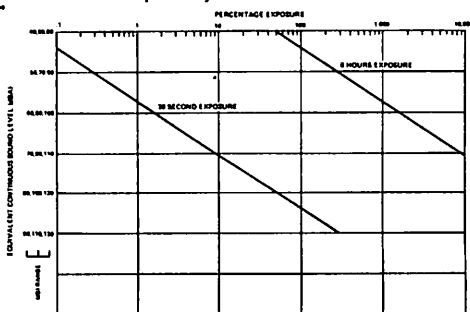

INDICATOR 1954-9720

The 1954-9720 Indicator converts the information stored in the 1954 Noise-Exposure Monitor and displays it as a four digit number. This number has different designations depending on the monitor in use. The indicator is also used to calibrate and reset the monitor as well as check the monitor battery.

Readout: The display will indicate either percentage exposure or index number and have a range of either 0.000 to 999.9 or 00.00 to 9999. The indication and display range are dependent on the monitor in use (see 1954 Noise-Exposure Monitor Specifications).

Allowable Level Exceeded: When the DISPLAY button is depressed, a light indicates if the specified ALLOWABLE LEVEL for the monitor in use (see 1954 Noise-Exposure Monitor Specifications), was exceeded during the monitoring period.

The allowable level exceeded circuit in the monitor is reset when the RESET button is depressed.

Calibration: A sound-level calibrator is included in the indicator. The calibrator tests all circuits in the monitor including the integrator. The calibration signal is applied as a steady tone. The calibration cycle will repeat automatically every 0.9 sec. by resetting the monitor, allowing calibration adjustment in a matter of seconds.

The calibrator operates at a frequency of 1000 Hz with an output level of 116.5 ± 0.5 dB re $20 \mu\text{Pa}$. Temperature coefficient is ± 0.02 dB/ $^{\circ}\text{C}$. Atmospheric pressure correction chart supplied.

Battery Check: The monitor battery voltage is checked by lighting an LED on the indicator if it is above the minimum operating voltage. Additionally, all lights are activated on the readout to (1) check the readout digits and (2) apply a heavier than normal load to the battery.

30-Second Sample Operation Mode: This mode is initiated by depressing and holding the RESET button. The display automatically indicates exposure when 30 (28.8 actual) seconds have lapsed. This number multiplied by 1000 predicts the 8-hour exposure.

Environment: TEMPERATURE: -10 to + 50 $^{\circ}$ C operating, -40 to + 60 $^{\circ}$ C storage. HUMIDITY: 0-90% RH at 40 $^{\circ}$ C.

Supplied: An accessory slide rule allows "equivalent continuous sound level" to be computed by entering the measurement period and the percentage or index number displayed.

Jeweler's screwdriver is supplied for calibration, activation of monitor controls, and access to battery compartment. Microphone extension assembly supports microphone on indicator when L_{eq} measurements are being made.

Available: 1954-9600 Carrying Case includes space for one indicator, ten monitors, microphone extension assembly, ten batteries, and miscellaneous small accessories.

Power: Supplied by battery in monitor.

Mechanical: DIMENSIONS (wxhxd): 3.31x14.5x2.39 in. (84x386x61 mm). WEIGHT: 2.7 lb (1.25 kg).



| Description | Catalog Number |
|---|----------------|
| 1954 Noise-Exposure Monitor, 5-dB exchange rate, meets U.S.A. OSHA requirements | 1954-9710 |
| 1954 Noise-Exposure Monitor, 3-dB exchange rate, meets ISO recommendations and IEC standards | 1954-9730 |
| 1954 Noise-Exposure Monitor, 4-dB exchange rate, meets USAF 161-35 requirements | 1954-9780 |
| 1954 Indicator, one indicator and at least one monitor comprise a complete dosimeter. Only one indicator is required for any numbers of monitors. | 1954-9720 |
| 1954-9785 Personal Noise Dosimeter, contains 5 each 1954-9780, one 1954-9720 and one 1954-9600 (meets USAF requirements) | 1954-9785 |
| 1954 Carrying Case, holds up to 10 monitors and one indicator | 1954-9600 |
| 1954 Windscreen Set, contains 4 windscreen assemblies | 1954-9610 |
| 1954 Microphone Assembly, includes 32-in. cable and connector, used on -9710, -9780 monitors | 1954-9630 |
| 1954 Microphone Assembly, includes 32-in. cable and connector, used on -9730 monitor | 1954-9640 |
| Shoulder Microphone Holder, 5 pack | 1954-9650 |
| Spare Battery, only one required to power both monitor and indicator | 8410-3400 |

*U.S. Patent Number 368,168

National stock numbers are listed before the Index.

1986 Omnicast Sound-Level Calibrator

- Capable of testing all the basic characteristics of virtually any acoustic instrument or system
- Multi-level and multi-frequency outputs
- Calibrated tone bursts
- Portable battery-operated

The 1986 is designed to permit checking nearly all the characteristics of a sound-level meter as specified by IEC and ANSI standards. With its supplied and optional microphone cavity adaptors, it can be used with all types and sizes of commonly used measurement microphones.

The calibrator includes tones at six different frequencies, from 125 Hz to 4000 Hz in octave steps, and five different sound-pressure levels, from 74 to 114 dB in 10-dB steps. This allows a sensitivity check of an acoustic instrument near the specific frequency and level of each measurement being made.

The frequency response of an overall sound-measuring system, weighting network or filter may also be checked.

The two sources of linearity error in a sound-measuring instrument are easily checked with the 1986. One source is the indicator scale (meter or digital display) and the other the level-range control. The multi-level output of the 1986 allows selection of different levels on a sound-measuring system and a check of the instrument's response at each level.

Standards require that Fast detector response be tested by applying a sinusoidal signal having a frequency of 1000 Hz and a duration of 200 ms. Slow detector response is tested by applying a sinusoidal signal having a frequency of 1000 Hz and a duration of 500 ms. The 1986's tone-burst mode allows checking to the above requirements by automatically presenting a 1000-Hz sinusoidal signal of either 200-ms or 500-ms duration.

The 1986 permits a check of rms accuracy and crest-factor capability by presenting repeated tone bursts with a high crest factor.

The transducer on the 1986 is resiliently mounted to protect against damage from the accidental bumps and drops often encountered in field calibration situations. The entire assembly, except for the test cavity, is enclosed in a molded plastic case that is tightly sealed against dust and moisture.

The cavity of the 1986 is designed to fit GenRad 1-inch microphones, the WE 640AA and Tokyo Riko MR 130. An adaptor is included to accommodate GenRad 1/2-inch microphones. An optional adaptor set allows you to use the 1986 on instruments with Bruel & Kjaer 1-inch, 1/2-inch and 1/4-inch microphones, the Shure Brothers 1 1/8-inch microphone, and the 3/8-inch microphone on GenRad's 1954 Noise Dosimeter.



Adaptors accommodate commonly used microphones.

SPECIFICATIONS

Output Sound-Pressure Levels: 74, 84, 94, 104, or 114 dB re 20 μ Pa.

Nominal Output Frequencies: 125, 250, 500, 1000, 2000 or 4000 Hz.

Actual Output Frequencies: Preferred per ANSI S1.6-1960 and ISO R266: 125.9, 251.2, 501.2, 1000, 1995 or 3981 Hz \pm 3%.

Reference Conditions: TEMPERATURE: 20° C (68° F). ATMOSPHERIC PRESSURE: 1013 mbar[†] (760 mm of Hg) (30 in. of Hg). RELATIVE HUMIDITY: 65%. MICROPHONE EFFECTIVE VOLUME: 0.5 cm³ (0.03 in.³) (nominal for GenRad 1961 Electret-Condenser Microphone*).

Accuracy of Sound-Pressure Level: Under stated reference environmental conditions, at 114-dB SPL and at all frequencies except 4000 Hz: \pm 0.25 dB for cavity alone or when used with any adaptor (except 1 1/8-in. adaptor: \pm 0.5 dB at 1000 Hz only); at 114-dB SPL and 4000 Hz: \pm 0.5 dB. At output levels other than 114-dB SPL, tolerance is increased by \pm 0.1 dB.

Temperature Coefficient of Sound-Pressure Level: Less than \pm 0.02 dB/° C (\pm 0.01 dB/° F for all frequencies except 4000 Hz).

Tone-Burst Signals: Test signals provided as prescribed by ANSI S1.4-1971; IEC Sound-Level Meter Standard 651. In tone-burst modes, output can be either continuous (SET FAST/SLOW or SET CREST FACTOR) or a series of bursts (FAST, SLOW or CREST FACTOR), as selected. Level is uncalibrated and continuously adjustable. In FAST or SLOW, peak amplitude of tone-burst is identical to that of continuous signal. In CREST FACTOR, rms value of tone-burst sequence is identical to that of continuous signal. FAST: Repeated tone bursts at 1000 Hz, 200-ms duration every 2's, for measuring sound-level-meter FAST rise response; amplitude is continuously variable from 72 dB to 118 dB re 20 μ Pa; background level is 20 dB below burst level. SLOW: Repeated tone bursts at 1000 Hz, 500-ms duration every 10 s, for measuring sound-level meter SLOW rise response; amplitude is continuously variable from 72 to 118 dB re 20 μ Pa; background level is 20 dB below burst level. CREST FACTOR: Repeated tone bursts at 2000 Hz, 5.5-ms duration, 40-Hz repetition rate, crest factor X3, for measuring rms detector-indicator accuracy and amplifier crest-factor capacity; rms amplitude is continuously variable from 75 to 111 dB re 20 μ Pa.

Variable Sound-Pressure-Level Control: Enabled only in tone-burst modes. Provides 11 dB of adjustment.

Electrical Output: Output provided from nominal 600- Ω shuntable source. Voltage proportional to sound pressure; 230-mV-rms nominal output corresponding to 114-dB SPL.

Distortion: Less than 1% THD acoustical or electrical.

Battery Test: Internal circuitry checks condition of battery continuously. Automatic instrument shutdown when battery voltage falls below acceptable range.

Microphone Coupling: Transducer cavity accommodates following 1-in. microphones: GR 1961 electret condenser*, GR 1971 ceramic, Western Electric 640AA and Tokyo Riko MR 103.

Environment: TEMPERATURE: -10 to + 50° C (+ 14 to + 122° F), operating; -40 to + 70° C (-40 to + 140° F), storage with battery removed. HUMIDITY: 0 to 90% RH, operating.

Accessories Supplied: Coupler-adaptor to accommodate GR 1982 1/2-in. electret-condenser microphone* and GR 1983 Sound-Level Meter microphone; 3 spare desiccant kits; battery; instruction manual.

Accessories Available: Adaptor set that includes coupler-adaptor for 3/8-in. GR 1954 Noise Dosimeter microphone; coupler-adaptors and "O" ring for 1-in, 1/2-in. and 1/4-in. B & K microphones, and coupler-adaptor for 1 1/8-in. Shure Brother microphones. Carrying case.

Power: Powered by 9-V alkaline battery, Mallory MN 1604 or Eveready 522 recommended. Battery provides at least 8-h continuous operation.

Mechanical: DIMENSIONS (wxhxd): approximately 280x67x165 mm (11x2.5/8x6 1/2 in.). WEIGHT: Approximately 1 kg (2.2 lb).

[†]In the international system of units (SI), the unit of pressure is the pascal (Pa), 1 Pa = 1 N/m² = 10 dynes/cm² = 10⁻⁴ mbar REF "The International System of Units (SI)," U.S. Dept. of Commerce, National Bureau of Standards, NBS Special Publication 330, SD Cat. No. C13. 10:330/2, U.S. GPO, Wash., D. C., 20402.

*U.S. Patent 4,070,741

| Description | Catalog Number |
|--|----------------|
| 1986 Omnicast Sound-Level Calibrator | 1986-9700 |
| Carrying Case | 1986-9600 |
| Calibrator Adaptor Set, adapts 1986 to: 3/8-in. microphone on GR 1954 Noise Dosimeter, B & K 1-, 1/2-, 1/4-in., and Shure Brothers 1 1/8-in. microphones. | 1987-9600 |
| Battery, spare (1 required) | 8410-3400 |

1987 Minical Sound-Level Calibrator

- Produces 1000 Hz at levels of 94 or 114 dB
- Compatible with all common measurement microphones

The 1987 Minical Sound-Level Calibrator is designed to allow quick, accurate field checks of acoustic instrument sensitivity. It produces a single-frequency output of 1000 Hz at sound-pressure levels of either 94 or 114 dB; it features a high-impact-resistant case and a special package design that makes it resistant to moisture, dust and mechanical shock. The 1987 Minical incorporates the same design features for accuracy and stability as those noted for the 1986 Omnical. It also couples to the same variety of microphone sizes as those listed for the 1986.

The 1987 is ideal for quick, daily calibration checks of sound-level meters and other acoustic instruments where sensitivity should be ascertained before and after measurements.

SPECIFICATIONS

Output Sound-Pressure Levels: 114 dB or 94 dB re 20 μ Pa[†] under reference conditions.

Output Frequency: 1000 Hz \pm 3%.

Reference Conditions: TEMPERATURE: 20° C (68° F). ATMOSPHERIC PRESSURE: 1013 mbar[†] (760 mm of Hg) (30 in. of Hg). RELATIVE HUMIDITY: 65%. MICROPHONE EFFECTIVE VOLUME: 0.5 cm³ (0.03 in.³) (nominal for GR 1961 Electret-Condenser Microphone^{*}).

Accuracy of Sound-Pressure Level: Under stated reference environmental conditions, \pm 0.25 dB for cavity alone, or cavity when used with any adaptor (except 1 1/8-in. adaptor: \pm 0.5 dB).

Temperature Coefficient of Sound-Pressure Level: Less than \pm 0.02 dB/^oC (\pm 0.01 dB/^oF).

Battery Test: Internal circuitry checks condition of battery continuously. Calibrator will not operate at all if battery voltage falls below acceptable range.

Microphone Coupling: Transducer cavity accommodates following 1-in. microphones: GR 1961 electret-condenser, ^{*} GR 1971 ceramic, Western Electric 640AA and Tokyo Riko MR103.

Environment: TEMPERATURE: -10 to + 50° C (+ 14 to + 122° F), operating; -40 to + 70° C (-40 to + 140° F), storage with battery removed. HUMIDITY: 0 to 90% RH, operating.

Accessories Supplied: Coupler-adaptor to accommodate GR 1962 1/2-in. electret-condenser microphone^{*} and GR 1983 Sound-Level Meter microphone; carrying pouch; 3 spare desiccant kits; battery; instruction manual.

Accessories Available: Adaptor set that includes coupler-adaptor for 3/8-in. GR 1954 Noise Dosimeter microphone; coupler-adaptors and "O" ring for 1-in., 1/2-in. and 1/4-in. B & K microphones, and coupler-adaptor for 1 1/8-in. Shure Brothers microphone.



Power: Powered by 9-V alkaline battery, Mallory MN 1604 or Eveready 522 recommended. Battery provides at least 20-h continuous operation.

Mechanical: DIMENSIONS (wxhxd): Approximately 63x63x89 mm (2 1/2x2 1/2x3 1/2 in.). WEIGHT: Approximately 270 gm (9.5 oz).

[†]In the International system of units (SI), the unit of pressure is the pascal (Pa); 1 Pa = 1 N/m² = 10 dynes/cm² = 10⁻² mbar. REF: "The International System of Units (SI)," U.S. Dept. of Commerce, National Bureau of Standards, NBS Special Publication 330, SD Cat. No. C 13, 10/330/2, U.S. GPO Wash., D.C., 20402.

^{*}U.S. Patent 4,070,741

| Description | Catalog Number |
|--|----------------|
| 1987 Minical Sound-Level Calibrator | 1987-9700 |
| Calibrator Adaptor Set, adapts 1987 to: 3/8-in. microphone on GR 1954 Noise Dosimeter, B & K 1-, 1/2-, 1/4-in., and Shure Brothers 1 1/8-in. microphones. | 1987-9600 |
| Battery, spare (1 required) | 8410-3400 |

1562-A Sound-Level Calibrator

- 125 to 2000 Hz
- ± 0.3 -dB accuracy at 500 Hz
- fits many microphones
- approved by MSHA

A handful of precision The 1562-A is a self-contained unit for making accurate field calibrations on microphones and sound-measuring instruments. This calibrator fits in the palm of your hand, operates on its own battery power, features a single fumble-free control, and provides a precisely known sound-pressure level at five ANSI-preferred frequencies.

Adaptors supplied with the 1562-A permit calibration of any GR 1 1/8", 1", or 1/2" microphone. Optional adaptors are available to permit calibration of most other standard-size microphones.

An electrical signal output is provided for tests on instruments without microphones, and a built-in indicator lamp checks for adequate battery voltage.

Typical GR Instruments that can be calibrated with the 1562-A are sound-level meters, octave-band analyzers, and sound and vibration analyzers.

SPECIFICATIONS

Acoustic Output: FREQUENCIES: 125, 250, 500, 1000, and 2000 Hz; $\pm 3\%$. SOUND-PRESSURE LEVEL: 114 dB re 20 μ Pa; accuracy at 23° C and 760 mm Hg is, for WE 640AA or equivalent microphone, ± 0.3 dB at 500 Hz and ± 0.5 dB at other frequencies; and, for other microphones, ± 0.5 dB at 500 Hz and ± 0.7 dB at other frequencies.

Electrical Output: 1 V $\pm 20\%$ behind 6 k Ω , flat $\pm 2\%$ with $<0.5\%$ distortion; available at phone jack.

Environment: TEMPERATURE: 0 to 50° C operating. Temperature coefficient of sound-pressure level is 0 to -0.012 dB/° C; correction chart supplied. HUMIDITY: 0 to 100% RH.

Supplied: Carrying case, adaptors for 1/2- and 1-in. microphones (fits 1 1/8-in. microphones without adaptor), battery.

Available: 1560-9561 Coupler Adaptor Set, for coupling 1562 to 1/8, 1/4, and 1/2-in. B & K microphones.

Power: Battery operated (9 V, Burgess PM6 or equal); 120 h use

Mechanical: DIMENSIONS: 5 in. (127 mm) long x 2.25 in. (57 mm) dia. WEIGHT: 1 lb (0.5 kg) net, 4 lb (1.9 kg), shipping.



| Description | Catalog Number |
|--|----------------|
| 1562-A Sound-Level Calibrator | 1562-9701 |
| Coupler Adaptor Set, adapts 1562-A to 1/8, 1/4, and 1/2-in. microphone | 1560-9561 |
| Battery, spare (1 required) | 8410-3000 |

1565 Audiometer Calibration Set

The 1565 Audiometer Calibration Set—faulty hearing or faulty audiometer? Studies have revealed that audiometers may have only a 50-50 chance of being accurate. Deficiencies include sound pressure at or beyond tolerance limits, faulty earphone performance, frequency outside limits, excessive harmonic distortion, and extraneous instrument noise.

With this fact in mind the 1565 Audiometer Calibration Set was conceived—a mini-system with maxi-benefits for tight budgets. The set contains a sound-level meter and earphone coupler to measure the output level and frequency response of the audiometer, a sound-level calibrator to ensure accurate readings from the sound-level meter, a calibration chart, a full set of instructions, and a convenient carrying case to keep everything together.

Earphone Couplers The set includes a 1560-P83B Earphone Coupler that fits GenRad 1-inch diameter microphones and Type L laboratory standard microphones such as the WE 640AA. The set can be used for calibrating the Telephonics TDH-39 and TDH-49 earphones with the earphone cushions (MX-41/AR) left in place.



SPECIFICATIONS

1565 AUDIOMETER CALIBRATION SET

Supplied: 1565-B Sound-Level Meter, 1987 Sound-Level Calibrator, earphone coupler, spare batteries, storage case.

Mechanical: DIMENSIONS (wxhxd): 11.25x4.25x10 in. (286x108x254 mm). WEIGHT: 5 lb (2.3 kg) net, 12 lb (6 kg) shipping.

EARPHONE COUPLER

1560-P83B: GR 9A (modified version of NBS type 9-A). VOLUME: 5.630 cm³ including volume added by microphone. AXIAL HOLDING FORCE: 450 grams nominal.

Frequency: 125 Hz to 8 kHz audiometric frequencies; response is equal to that obtained with NBS 9-A coupler within 1 dB to 4 kHz and 1.5 dB to 8 kHz when it is used with TDH-39 or TDH-49 earphone in MX-41/AR ear-cushion.

Mechanical: **1560-P83B:** DIMENSIONS: Coupler, 2.94 in. dia x 1.25 in. high (75x32 mm); overall (wxhxd), 2.94x 3.5x3.5 in. (75x90x90 mm). WEIGHT: 0.5 lb (0.3 kg) net, 2 lb (1 kg) shipping.

| Description | Catalog Number |
|--|----------------|
| 1565 Audiometer Calibration Set | 1565-9911 |
| 1560-P83B Earphone Coupler, GR type 9A | 1560-9685 |
| Battery, spare for 1565-B (2 required) | 8410-3200 |
| Battery, spare for 1987 (1 required) | 8410-3400 |

1933 Audiometer Calibration System

Your best choice for compliance with current and proposed OSHA regulations

- The system lets you calibrate audiometers and check attenuator linearity over the range of 10 dB to 90 dB HL
- Calibration chart documents sound-level-meter readings for popular TDH-39, -49, and -50 earphones to simplify calibration
- Precision sound-level meter gives you A-, B-, and C-weighting and impulse/impact capability, plus octave-band analysis to perform many other OSHA-required measurements

No matter how well planned a hearing conservation program may be or how carefully the equipment has been selected, the entire effort can be jeopardized by insufficient evidence that instruments have been performing properly. OSHA recognizes this and requires that audiometers be calibrated periodically.

Key elements in the system for audiometer calibration are a 1933 Precision Sound-Level Meter and Analyzer, a 1562-A Sound-Level Calibrator, and a 1560-P83B Earphone Coupler. The earphone coupler couples a TDH-39, -49, or -50 earphone to the sound-level meter's microphone in a sealed cavity of standard size and shape and simulates compliance of the human ear. A calibration chart, included, documents sound-level-meter readings at 70 and 90 HL, eliminating cumbersome manual calibration. Basic microphone-pressure-response data are also provided to facilitate more detailed investigations.

Other items included with the system make it a versatile tool for a number of other OSHA-required measurements. These accessories are listed in the specifications section and comprise a very complete measurement system with which you can make plant noise surveys of both continuous and impact noise, audiometric booth-site surveys, measurements for noise reduction, hearing protector evaluations, and other general-purpose measurements.

The 1933 has several features to help simplify accurate measurements. The microphone is mounted on a 12-inch extension mast to eliminate reflections from the meter case and observer. An automatic attenuator system eliminates wrong settings and a linear meter scale (20-dB range) makes meter reading virtually mistake proof.

SPECIFICATIONS

1933-9716 AUDIOMETER CALIBRATION SYSTEM

Supplied: 1933-9700 Precision Sound-Level Meter and Analyzer, including 1/2-inch and 1-inch flat random-incidence electret-condenser microphones, microphone attenuator, tool kit, microphone extension cable (10-ft) and batteries; dummy microphone; 1/2-inch and 1-inch windscreens (one each); earphone; 1562-A Sound-Level Calibrator, with adaptors for 1/2-inch and 1-inch microphones, and batteries; 1560-P83B Earphone Coupler; 1933-9603 Carrying Case with custom-padded insert to accommodate all system components plus a compartment for instruction manuals and other paperwork.



Mechanical: DIMENSIONS (wxhxd): 19x14.5x6 in. (483x370x152 mm.) WEIGHT: 15 lb (7 kg) net, 17 lb (8 kg) shipping.

1560-P83B EARPHONE COUPLER

GR 9A, fulfills the requirements of NBS type 9-A.

Volume: 5.630 cm³ including volume added by microphone.

Axial Holding Force: 450 grams nominal.

Frequency: 125 Hz to 8 kHz, audiometric frequencies; response is equal to that obtained with NBS 9-A coupler within 1 dB to 4 kHz and 1.5 dB to 8 kHz when it is used with TDH-39, -49, or -50 earphone in MX-41 / AR ear-cushion.

Mechanical: DIMENSIONS: Coupler, 2.94 in. dia. x 1.25 in. high (75x32 mm); over-all (wxhxd), 2.94x3.5x3.5 in. (75x90x90 mm). WEIGHT: 0.5 lb (0.3 kg) net.

| Description | Catalog Number |
|------------------------------------|----------------|
| 1933 Audiometer Calibration System | 1933-9716 |

1560-9619 Audiometer Calibration Accessory Kit

- permits field calibration of audiometers with accuracy comparable to factory calibration
- stable, bench-mounted base for microphone and earphone coupler
- supplied with precision, one-inch electret-condenser microphone
- includes all necessary calibration data

The 1560-9619 Audiometer Calibration Accessory Kit is designed to be used with either the GenRad 1982 or 1933 Precision Sound-Level Meter and Analyzer for the precise calibration of audiometers. When used with these meters, it permits the periodic calibration of audiometers as required by OSHA and other agencies, to the sound-pressure-level values specified in ANSI S3.6 1969 or other standards which require the NBS Type 9-A coupler to be used in the measurement procedure.

The kit contains all the necessary components needed to measure the acoustic output of audiometers when used with the 1982 or 1933. An optional acoustic calibrator such as the GenRad 1986 or 1987 enables the user to make an independent acoustical check of the measuring system. Included in the kit are a GR 1560-P83B Earphone Coupler which fulfills the requirements of NBS Type 9-A, a 1-inch GenRad Electret-Condenser Microphone, an adaptor (1-inch to 1/2-inch thread), audiometer calibration stand assembly, calibration chart, and instruction sheet.

Calibration Data The calibration chart in the kit documents octave band sound-pressure levels for 125 Hz to 8000 Hz. Data are given for an audiometer setting of 70 dB HL for the TDH-39 earphone, and both 70 dB HL and 90 dB HL for the TDH-49 and TDH-50 earphones. Readings are given for the flat and A-weighted scale on the 1982 and 1933 Precision Sound-Level Meters and Analyzers.

Pressure-response corrections for the supplied microphone in a 1560-P83B coupler are provided for octave-band frequencies 125 Hz to 8000 Hz.

Stable stand assembly The audiometer calibration stand assembly is a cast metal stand which supports the 1-inch microphone, earphone coupler, and 1982 or 1933 pre-amplifier. It has a polyethylene-foam base for isolation against shock and vibration during the measurement.

The stand eliminates mounting the earphone coupler directly on the sound-level meter and the subsequent risk of the meter falling over.

Easy set-up and use 1. To use the 1560-9619 kit with a 1982 or 1933 Precision Sound-Level Meter and Analyzer, the preamplifier and microphone must be removed from the meter. This simple procedure is detailed in the 1982 and 1933 instruction manuals.

2. Install the 10-foot extension cable on the 1982 or 1933. This cable is supplied with both meters.

3. Feed the free end of the cable through the legs of the stand assembly and through the opening in the middle of the stand, and connect the preamplifier to the cable.



4. Screw the 1-inch microphone, supplied with the 1560-9619, onto the preamplifier and gently lower it into the stand cavity.

5. Place the 1986 or 1987 Calibrator over the 1-inch microphone and calibrate the sound-level meter in accordance with standard calibration procedure.

6. Install the earphone coupler on the microphone. The system is now ready for use.

SPECIFICATIONS

Frequency Range: 125 Hz to 8 kHz.

Accuracy: The electret microphone response in a 1560-P83B Type 9-A coupler is calibrated to be equal to the response of a type L microphone in an NBS 9-A coupler when used to calibrate TDH-39, TDH-49 and TDH-50 earphones mounted in a MX41 /AR ear cushion. MICROPHONE/COUPLER CALIBRATION: (Factory), ± 0.2 dB—125 Hz to 4 kHz; ± 0.3 dB—6 kHz to 8 kHz. System accuracy when used with 1933-9700 or 1982-9700 and the microphone supplied with the 1560-9619 and calibrated with the 1986 or 1987 Acoustic Calibrator is within 1 dB at audiometric test frequencies 125 Hz to 4 kHz; 1.5 dB at audiometric test frequencies 6 kHz and 8 kHz.

Earphone Coupler: The GR 1560-P83B 9-A type coupler fulfills the volume requirements for the NBS 9-A coupler specified in ANSI S3.7 1973 when used with the GR 1961-9610 one-inch electret-condenser microphone. VOLUME: $5.630 \text{ cm}^3 \pm 0.030 \text{ cm}^3$ including volume added by microphone. AXIAL HOLD FORCE: 450 grams nominal.

Microphone: GR 1961-9610 1-inch electret-condenser microphone, random-incidence response with pressure-response corrections given for audiometer test frequencies.

Environmental: (1961-9610 1-inch microphone only). TEMPERATURE: -20 to + 55° C and 90% RH operating.

Supplied: (1560-9619): 1560-9685 Earphone Coupler, 1961-9610 Microphone, 1560-9618 Audiometer Calibration Stand Assembly, Calibration Chart, Instruction Sheet, adaptor.

Available: 1560-9618 Audiometer Calibration Stand Assembly, supplied as part of the 1560-9619, is also available separately. This offers the present user of the 1933-9716 Audiometer Calibration System a stable, bench-mounted stand for the earphone coupler and microphone.

Mechanical: DIMENSIONS: 1560-9618 Stand Assembly, 10 in. high x 3.87 in. dia (254x98 mm). WEIGHT: 2.4 lb (1.1 kg) net, 5 lb (2.3 kg) shipping.

| Description | Catalog Number |
|---------------------------------------|----------------|
| Audiometer Calibration Accessory Kit | 1560-9619 |
| Audiometer Calibration Stand Assembly | 1560-9618 |

1557-A Vibration Calibrator

- calibrates vibration pickups, meters
- generates 1 g at 100 Hz
- portable, battery-operated

This calibrator provides a single-frequency (100 Hz), single-level (1 g) check on the GR Vibration Pickups or any pickup whose total mass is 300 grams or less. It can provide on-the-spot calibration of vibration-measuring systems immediately before and after important measurements and can also be used to compare transducers or to calibrate working transducers against a standard transducer.

Operation of the calibrator is simple. A pickup of known mass is attached to the shaker, either in place of one of the removable 50-gram disks or to one of the disks by double-faced, pressure-sensitive tape. The user adjusts the Level control until the panel meter, calibrated in grams, indicates the mass of the pickup. The pickup will then be automatically subjected to an acceleration of 1 g at 100 Hz.

The 1557-A is a small, battery-operated unit consisting of a transistorized electromechanical oscillator and a cylindrical shaker. The acceleration output of the calibrator appears at two pillbox-shaped, 50-gram disks mounted on an internal cylinder that projects through the sides of the instrument.

SPECIFICATIONS

Output: ACCELERATION: 1 g rms \pm 10%. 1 g = 386 in./s² (9.81 m/s²). VELOCITY: 0.614 in./s (15.6 mm/s) rms. DISPLACEMENT: 0.000978 in. (0.0248 mm) rms; 0.00277 in. (0.0704 mm) pk-pk. FREQUENCY: 100 Hz \pm 1% for 50-gram load; 100 Hz + 0, -2% for 300-gram load.

Power: Battery operated (Eveready 724 or equivalent dry cell).

Supplied: Leather carrying case.

Mechanical: Aluminum case. DIMENSIONS (wxhxd): 4x8x4 in. (105x205x105 mm). WEIGHT: 3.25 lb (1.5 kg), net; 5.25 lb (2.4kg) shipping.

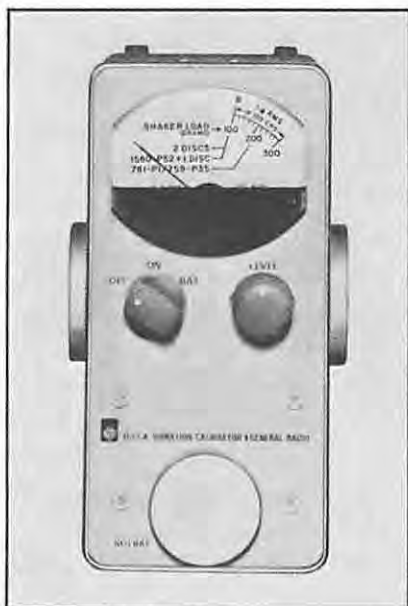

View of the calibrator with Type 1560-P52 Vibration Pick-up attached.

| Description | Catalog Number |
|--|----------------|
| 1557-A Vibration Calibrator (with dry battery) | 1557-9792 |
| Replacement Dry Cell, 1 req'd | 8410-1050 |

1995 Integrating Real Time Analyzer

- 25 Hz to 20 kHz or 2.5 Hz to 20 kHz
- 1/3-octave and full-octave real-time analysis
- built-in display scope features bar-graph display or numerical listing
- small and lightweight
- power-line or battery operation for truly portable use
- 50-dB display range
- integration times from 1/8-second to 24 hours
- spectrum comparison capability

The 1995 is designed to satisfy a broad range of noise-measurement requirements in real time, on the spot without the need to make tape recordings for detailed analysis back in the laboratory. A compact, light-weight, micro-processor-based instrument, it can operate from optional rechargeable batteries for truly portable on-site measurements. This is the first instrument in its class that is not dependent on an external power source.

The 1995 is a one-third and full-octave real-time analyzer with long-term integration capabilities. It also operates as an integrating analyzer or integrating sound-level meter to display A-weighted sound level, Flat response, or any selected band level as a function of time.

A built-in display scope features a bar-graph display of one-third-octave or full-octave bands, and a pushbutton allows the user to convert the bar graph to a numerical display with standard deviations listed for each band. Spectrum storage is also built-in, allowing the storage of a spectrum for recall and comparison with new data. The stored spectrum can be retained for a long period of time since the internal memory is powered by a separate battery.

The 1995 is an excellent tool for industrial-noise, community-noise and product-noise applications. Typical applications include:

- Plant and machinery noise reduction
- Sound-power measurements per EPA standards
- Machine-tool measurements per NMTBA
- Aircraft-noise measurements per FAR-36
- Motor-vehicle-passby measurements
- Community-noise measurements (e.g., L_{ew})
- Product-noise rating and reduction
- Product-line testing

SPECIFICATIONS

Standards: FILTERS: One-third-octave filters in accordance with: ANSI Standard Specification for Octave, Half-Octave and Third-Octave-Band Filter Sets S1.11 1966, Type E, Class III; IEC Recommendation Publication 225-1966, Octave, Half-Octave and Third-Octave-Band Filters for the Analysis of Sound and Vibration; DIN 45 652, 1964 Third-Octave-Band Filters for Electroacoustical Measurements, A-weighting characteristics and Fast and Slow responses in accordance with: ANSI Standard Specification for Sound-Level Meters S1.4-1971, Type 1;



IEC Sound-Level Meter Standard 651 Type 1, DIN 45 653/1, 1970, Precision Sound-Level Meters General Requirements.

Preamplifier Input: MICROPHONES AND ACCELEROMETERS: Preamplifier has 0.460x60 thread for direct connection to one-half inch electret-condenser or air-condenser microphone and various adaptors for use with other microphones and accelerometers. Switchable polarizing voltage for use with air-condenser microphones is provided. **ELECTRICAL SIGNALS:** BNC to the amplifier thread adaptor is available.

Level Range for Direct Reading in dB re 20 μ Pa

| Nominal Microphone Sensitivity dB re 1 V/Pa | Microphone Sensitivity Range dB re 1 V/Pa | Level Range* For Direct Reading dB re 20 μ Pa | Corresponding Voltage Range |
|---|---|---|-----------------------------|
| 30 | 26 to 36 | 120 to 20 | 63 V to 6.3 μ V |
| 40 | 36 to 46 | 130 to 20 | 63 V to 2 μ V |
| 50 | 46 to 56 | 140 to 20 | 63 V to 63 μ V |
| 60 | 56 to 66 | 140 to 30 | 2 V to 63 μ V |

*Lower level may be limited due to noise depending on the capacitance of the microphone used, its exact sensitivity, and the particular pass band or weighting. Units apply with preamplifier set to X1 gain. Lower limit may be extended by setting the preamplifier to X10 gain.

Typical sensitivity of GR 1971 Ceramic and 1962 Electret-Condenser Microphones is 40 dB re 1 V/Pa. Equivalent A weighted noise for 1971 Ceramic Microphone: 21 dB; for 1962 Electret-Condenser Microphone: 27 dB. One third-octave band levels are typically less than 10 dB for bands from 25 Hz to 20 kHz with 1971 Microphone. One third octave band levels decrease with increasing frequency for 1962 Microphone, ranging from typically 30 dB at 25 Hz to 12 dB at 20 kHz.

IMPEDANCE: Approximately 2G Ω in parallel with less than 6 pF. **CALIBRATION ADJUSTMENT:** Rear-panel screw-driver adjustment with 10-dB total range. **MAXIMUM INPUT:** For linear operation + 5 V peak.

Tape Input (rear panel): CONNECTOR: Tape input connector; BNC. **SENSITIVITY:** Nominally 1 V rms full scale. Independent of full-scale range selected and continuously adjustable from 0.316 V to 3.16 V rms full scale. **IMPE-DANCE:** 100 k Ω , ac coupled. **MAXIMUM INPUT:** For linear operation, a peak signal 20 dB above full-scale settling; \pm 32 V peak without damage. Maximum dc input, \pm 30 V without damage.

Overload Indication: Indication of overload on display when peak input voltage exceeds linear range (non-latching).

Filters: **FREQUENCY RANGE:** 1995-9700 and 1995-9720: 25 Hz-to-20 kHz one-third-octave center frequencies (standard bands 14 to 43), or 31.5 Hz to 16 kHz, one-octave-band center frequencies (bands 15 to 42); 1995-9710 and 1995-9730: 2.5 Hz-to-20 kHz (bands 4 to 43) one-third octave or 4 Hz-to-16 kHz octave-band center frequencies (bands 6 to 42). **BANDWIDTH:** Bandwidths of one-third octave or one octave (octaves derived by summing 1/3 octaves). Either result may be displayed at completion of analysis. **CHARACTERISTICS:** One-third-octave filters have nominal 6-pole Butterworth response.

Weighting: A.

Proweighting: Flat or A ahead of filters.

AC Output: Flat output unfiltered provides 0.5 V rms nominal at full scale, output provided from 5 k Ω shortable source.

Video Output: Composite video; negative sync; 1 V p-p into 75 Ω . 8-MHz picture element rate.

Detector and Integrator: **DETECTOR RESPONSE:** True Square Law (rms). **SOUND-PRESSURE LEVEL:** Sound-pressure level with either integration or exponential averaging as selected by operator. **SOUND-EXPOSURE LEVEL:** Sound-exposure level (time reference one second) selected by operator: **INTEGRATION TIMES:** 1/8, 1/4, 1/2, 1, 2, 4, 8, 9, 10, 15, 24 seconds, minutes or hours selectable by operator in linear modes; 1/8, 1/4, 1/2, 1, 2, 4, 8, 9, 10, 15, 24 seconds or minutes selectable by operator in exponential mode. In exponential mode, time constants of 1/8 second and 1 second correspond to FAST and SLOW sound-level meter responses, respectively. **DYNAMIC RANGE:** Dynamic range, including 10 dB allowance for crest factor above full scale, is 63 dB. Linearity error less than \pm 0.75 dB for sine wave inputs ranging from +7 dB to -40 dB re full scale and less than +1 dB for inputs ranging from -40 to -50 dB re full scale. Resolution is 0.25 dB. **CREST FACTOR:** At least 10 dB at full scale. **OVERLOAD INDICATION:** Indication of overload on display when the integrated level in any band exceeds full scale (non-latching).

Display: **TYPE:** Five-inch raster-scan display with tube face recessed to permit viewing in bright ambient light. **POWER:** Controlled by front-panel switch. Display may be turned off to conserve battery power without affecting performance of instrument. **RANGE:** 50 dB displayed. Full-scale sensitivity selectable from 70 to 140 dB re 20 μ Pa in 10-dB steps. **LEVEL-VS-FREQUENCY:** Bar graph display of one-third octave or one octave band levels

plus A-weighted and flat-response levels. A second result, previously stored, may be displayed as a line graph, superposed on the bar graph, for comparison. Status information and one band level (selected by "cursor") displayed alphanumerically. **LEVEL-VS-TIME:** Bar graph of up to 32 sequential integration results plus status information and one integration result (selected by "cursor") displayed alphanumerically. **NUMERICAL RESULT:** All band numbers, levels, and standard deviations (except for octaves) are listed numerically along with status information. In level-vs-time mode, all integration periods and corresponding levels and standard deviations (except for octaves) are displayed. **CURSOR:** A cursor operates in the graphical mode to display the band number, level, and standard deviation of any one selected band. The bar corresponding to the selected band is intensified for identification. **STORAGE:** A displayed result may be stored and then recalled and displayed alone or superposed on a "real time" result. A composite one-third-octave spectrum developed from one-third-octave band-level maximums in a series of integrations is stored and may be displayed alone or superposed on a "real time" or stored spectrum. **DATA REDUCTION:** In the REDUCED DATA mode, A-weighted and flat-response sound levels and Speech Interference Level are displayed.

Calibration: A built-in noise source permits an overall check on all channels. Overall system calibration, including accessory preamplifier, microphone, or accelerometer, can be performed using any acoustic or vibration calibrator.

Basic Input/Output Interface to Accessories: **VIDEO OUTPUT:** A composite video output signal permits use of large external monitors for display. **START-STOP-PAUSE:** A TTL compatible input allows remote control of panel START, STOP, and PAUSE functions.

Optional Interface to Accessories: **X-Y RECORDER:** An optional output interface in the 1995-9720 and -9730 supplies a 1-V full-scale signal for an X-Y plotter or level recorder. Recorder calibration voltages of 1-V full scale for both axes are available. **LEVEL RECORDER:** Synchronizing and pen lift circuits permit use of GR 1523 recorders. **IEEE 488 INTERFACE:** Optional output interface supplies digital data in IEEE 488 format, permitting use of data printers, computers, calculators, and other accessories compatible with the standard.

Environment: **OPERATING TEMPERATURE RANGE:** 0 to 50 $^{\circ}$ C. **STORAGE TEMPERATURE RANGE:** -40 to +70 $^{\circ}$ C with power supply; -40 to +60 $^{\circ}$ C with batteries. **HUMIDITY:** Operating, up to 90% RH at 40 $^{\circ}$ C.

Power Supply: **LINE POWER SUPPLY:** 1995-3040 plugs into rear-panel recess. Can be removed and replaced with optional rechargeable battery pack plug-in. Power consumption from line is 40 W maximum. Operates from 90 to 125 V or 180 to 250 V, 50 to 60 Hz. Used either to power the instrument or to recharge the batteries. **BATTERY POWER SUPPLY:** Optional rechargeable battery plug-in 1995-3030 provides at least one hour of operation with display on, at least two hours with display off. Battery is charged from power supply to 80% of full

capacity in approximately eight hours. **BATTERY VOLTAGE INDICATION:** Low battery voltage is indicated on the display.

Accessories Supplied: Rear-panel mating connector with unterminated 5-foot cable, 2 each; front-panel cable connector lock; preamplifier; 10-foot preamplifier cable.

Accessories Available: Rechargeable battery pack and accessories; camera adaptor set; carrying case.

Mechanical: **OVERALL DIMENSIONS** (not including handle): (wxhxd): 17x7x17.5 in. (432x178x444 mm).

WEIGHT (including removable ac power supply): 1995-9700, 41 lb (18.6 kg); 1995-9710, 42.5 lb (19.3 kg); 1995-9720, 42 lb (19.0 kg); 1995-9730, 43.5 lb (19.7 kg).

| Description | Catalog Number |
|--|----------------|
| 1995 Integrating Real-Time Analyzer (25 Hz to 20 kHz) | 1995-9700 |
| 1995 Integrating Real-Time Analyzer (2.5 Hz to 20 kHz) | 1995-9710 |
| 1995 Integrating Real-Time Analyzer (25 Hz to 20 kHz) with output interface | 1995-9720 |
| 1995 Integrating Real-Time Analyzer (2.5 Hz to 20 kHz) with output interface | 1995-9730 |
| Rechargeable Battery Pack and Accessories | 1995-9600 |
| Camera Adaptor Set (includes hood, bracket, and close-up lens) | 1995-9601 |
| Carry Case (for accessories): provides space for calibrator, 60-ft cable, battery pack, tripod, microphones, and preamplifiers | 1995-9602 |

2512 Spectrum Analyzer

- fast spectrum analysis—up to 100 kHz
- fast real-time analysis—up to 20 kHz
- flexible display calibration
- fully annotated and calibrated displays
- uncomplicated control interface
- portable

GenRad's 2512 spectrum analyzer gives you the power, speed and accuracy you need for studying sound and vibration problems—all neatly packaged in a light-weight portable instrument. All the features of earlier generations of spectrum analyzers are included in the GR 2512, plus higher real-time bandwidth, a stable raster-scan display and a simple operator interface.

Easier to use than an oscilloscope

The front panel has a minimal number of pushbutton controls. The operator deals with only one function at a time due to the sophisticated interaction between the display and controls. Operation of similar equipment often requires a thorough understanding of a maze of switches, knobs, and buttons.

Ideal for lab or field applications Lightweight, at approximately 38 pounds, the 2512 is compact enough to carry conveniently to the most remote sites.

SPECIFICATIONS

Frequency Range: DC 10 Hz to dc 100 kHz in a 1-2-5 sequence.

Resolution: 400 lines of frequency resolution.

Frequency Accuracy: Better than $\pm 0.1\%$ from 0 to 45° C, crystal controlled.

Real-Time Frequency: 20 kHz.

Amplitude Linearity: $\pm .05\%$ full scale.

Minimum Detectable Signal: 70-dB two-tone dynamic range with averaging.

Anti-Aliasing Filter: Included; 96 dB-per-octave rolloff, automatically selected with frequency range.

Input Sensitivity: 1 mV rms full scale to 10 V rms full scale.

Input Impedance: 1 M Ω shunted by 115 pF nominal.

Input Coupling: AC, dc, test-integral square-wave test.

AC Rolloff: -3 dB at 1 Hz.

Maximum Input: 30 V rms, continuous, on all ranges ± 100 V peak 5 s, transient.

Input Connector: BNC on front panel. Three-terminal microphone connector on rear panel with +18-V bias available for microphone preamplifiers.

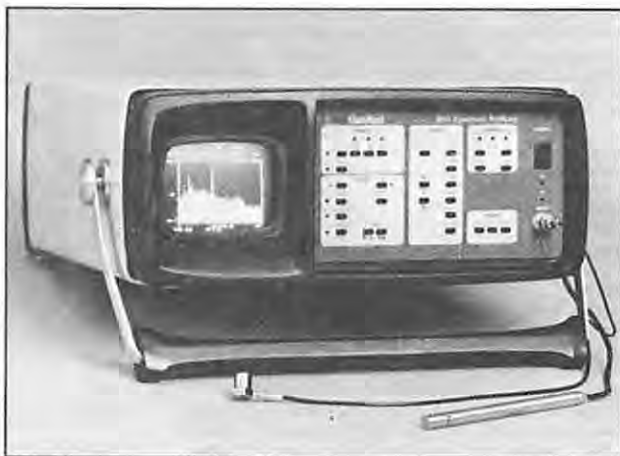

Overload Indicator: Front-panel LED is activated for 1/4 s when input exceeds approximately 95% of full-scale range selected.

Low-Level Indicator: Front-panel LED turns on when signal remains at less than 10% of full scale for more than 1/8 second, turns off when signal exceeds 10% of full scale.

Display Functions: Front-panel pushbutton selection of: input versus time, unaveraged spectrum, averaged spectrum, stored spectrum or simultaneous averaged and stored spectra.

Display Calibrations (User Selected): dB re 1 V rms, dB re engineering units, linear volts, volts², volts²/Hz, and volts²-s/Hz and linear re millivolts per engineering unit, also linear and log frequency in Hz or CPM.

Type of Display: Raster scan with full alphanumeric labeling and electronically-generated graticule. Alphanumeric labeling reflects all operational control settings as well as full calibration data for frequency or time and level.

Graphic Resolution: All 400 frequency lines are displayed and visible. Alphanumeric labeling on CRT gives operator complete status of all control settings. These include input coupling, voltage range, type of averaging, number of averages, type of triggering, windowing invoked, and calibrated annotation of graphic axes.

Cursor: Single, harmonic or sideband with one-screen display of frequency of main cursor and level. Frequency may be read in Hz or CPM dependent upon display mode selected. Level is read in dB re 1 V, dB re E.U., absolute voltage or linear E.U. This function is set by the display scale and E.U. set controls. Sideband also displays

frequency between cursors. Cursors operational in input-spectrum, average-spectrum and stored-spectrum modes.

Engineering Units: Display can be calibrated in units relative to engineering units. Vertical scale settable in dB (± 150.0 in 0.1 dB steps) or linear units of 0.1 to 100.0 mV per E.U.

Triggering: Free run, external or internal (rear-panel selected), slope + or -, level \pm full scale in 20% steps. Transient: Capture delay time of -0.5, -0.25, -0.125, 0, + 0.125, + 0.25, + 0.5, + 1, + 2 of frame time. External input impedance (rear panel) 1 M Ω dc coupled. Indicators: ARM and HOLD indicated by front-panel LED.

Windowing of Data (User Selected): Hanning on or off, or auto (sets Hanning on for free run and off for triggered analysis).

Averaging: Additive, subtractive, exponential, max hold. Number of averages selectable from 1 to 1024 in binary steps.

Spectrum Storage: Memory provided for storage of a reference spectrum. Activated by front-panel button.

Miscellaneous: Front-Panel Connector: BNC signal input. Rear Panel Connectors: Three-Terminal connector. Signal input in parallel with front panel BNC, remote CRT video and synch (BNC), X and Y plotter, pen lift (BNC), external trigger (BNC), external sample input (BNC), digital I/O and optional IEEE 488 bus.

Environment: TEMPERATURE: 0 to 45° C operating.

Supplied: Power cord.

Power: 87 to 125 or 178 to 250 V. 45-66 Hz, 150 W.

Mechanical: Portable, light-weight cabinet. DIMENSIONS (wxhxd): 18.7x7.33x20.88 in; 24.18-in. depth with handle extended (475x186x530 mm; 613.8-mm depth with handle extended). WEIGHT: 38 lb (17.3 kg) net, approx 55 lb (24.97 kg) shipping.

| Description | Catalog Number |
|---|----------------|
| 2512 Spectrum Analyzer (universal frequency and voltage) | 2512-9700 |
| Select following options, if desired | |
| IEEE 488 Bus, allows interfacing with other IEEE compatible equipment | 2512-9400 |
| XY Plotter Alphanumeric, plots the grid and all text displayed on the 2512 CRT | 2512-9401 |
| Large-Screen Monitor, using a 12" Raster Scan Display | 2512-9402 |
| Frequency Translator (Zoom), permits increased resolution by expanding the spectrum around a chosen frequency | 2512-9403 |
| Rack-Mount Kit, used to Slide Mount the 2512 into a standard 19" rack | 2512-9404 |
| 1/1, 1/3-Octave Analysis, provides synthesized 1/3 Octave (Class III) and 1/1 Octave (Class II) equivalent filters with Flat or A weighting | 2512-9405 |
| Camera Adaptor (Includes bezel hood, bracket and close-up lens) | 1995-9601 |

1925 Multifilter

- 3.15 Hz to 80 kHz
- 1/3-octave bands
- calibrated channel attenuators
- display with standard scale factor
- scanned, parallel, and summed outputs

Spectrum shaper or analyzer building block The 1925 Multifilter contains up to 30 parallel one-third-octave-band filters from 3.15 Hz to 80 kHz and is supplied with attenuators that permit independent control of the gain in each band. The attenuators let you use the multifilter as an equalizer or spectrum shaper to simulate or to compensate for irregularities in the frequency response of electrical or acoustical transmission systems or transducers. You can also use it as the basis for a serial or parallel frequency analysis system.

A variety of outputs The outputs from the individual filters are presented simultaneously in parallel, summed in a single output, and selected individually by manual switching, by external switch closure, or by a remote scanner control unit. Additional outputs provide the unfiltered input signal and the signal with A, B, or C weighting imposed. Peak detectors located before and after the filters drive a metering circuit that selects the highest peak and gives you an indication in decibels referred to the overload level.

Attenuator for each band Each attenuator provides 50 dB of gain control in 1-dB steps, accurate to ± 0.25 dB. Thumbwheel switches control the attenuation and a panel display indicates the "transmission" of the instrument. This display has the same scale as the 1521-9463 chart paper used with the 1564-A Sound and Vibration Analyzer (5 in./decade horizontal, 10 dB/in. vertical). A key-operated lock guards against unintended changes in the attenuator control settings.

Filters meet American and international standards The filters, built on plug-in etched boards (three per board) for easy interchange, are available with one-third-octave bandwidths that conform to both American and international standards. The A-, B-, and C- weighting characteristics also conform to the requirements of the various standards for sound-level meters.

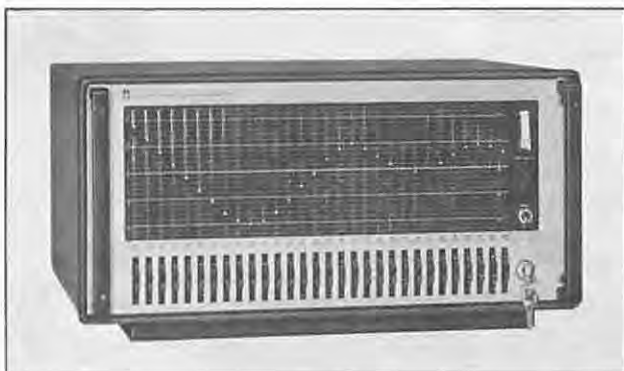

SPECIFICATIONS

Frequency: 3.15 Hz to 80 kHz.

Bandwidth: 1/3 octave.

Peak Monitor: A peak detector senses levels at two circuit points and drives a panel meter calibrated in dB referred to overload level. A signal proportional to meter indication is available at a rear connector to drive a dc recorder; 1 mA for full-scale reading.

Input: Connects to rear BNC or microphone connector. **GAIN:** 0 dB nominal. **MAXIMUM INPUT:** 35 V dc, 17 V peak ac. **IMPEDANCE:** 100 kΩ.

Attenuation: + 6 to -12-dB continuous gain adjustment common to all channels plus + 25 to -25-dB attenuation in 1-dB steps with ± 0.25-dB accuracy (re + 25-dB setting) by means of a panel thumbwheel switch for each band. Attenuation of each band is indicated by a dot on panel display and represents the transmission between input and summed output. Display has standard 50-dB per decade scale factor; 10-dB per in. vertical, 5 in. per decade horizontal. Lock on panel prevents accidental changes in attenuator settings.

Response: 30 6-pole Butterworth filters with 1/3-octave effective (noise) bandwidths that conform to ANSI S1.11-1966 Class III (high attenuation) and IEC 225-1966 standards. **ACCURACY** of center frequency: ± 2%. **LEVEL UNIFORMITY:** Within ± 0.50 dB at 25° C, ± 0.75 dB from 0 to 50° C, at center frequency with attenuator at + 25 dB. **PASSBAND RIPPLE:** 0.5 dB max pk-pk. **NOISE:** <15 μV equivalent input noise. **HARMONIC DISTORTION:** < 0.25% at 1-V output for bands centered below 25 Hz, < 0.1% at 1-V output for 25 Hz and above. **WEIGHTING:** A, B, C, conforming to ANSI S1.4, IEC 651.

Outputs: **PARALLEL BAND OUTPUTS:** ± 4.2 V max (3 V rms) behind 20 Ω nominal; 3 kΩ min load for max output voltage. **SCANNED BAND OUTPUT:** ± 4.2 V max (3 V rms) behind 20 Ω ; 3 kΩ min load for max output voltage. Two chassis can be wired in parallel for up to 60 scanned outputs. **SUMMED OUTPUT** (for equalizing and shaping applications): ± 4.2 V max open circuit behind 600 Ω ; impedance of load does not affect output linearity. **WEIGHTED AND UNFILTERED OUTPUTS:** 0-dB nominal gain at 1 kHz, behind 20 Ω nominal; 30 kΩ min load for max output voltage.

Supplied: Power cord, two 36-pin type 57 plugs to mate with rear connectors.

1925-9670 Transmission Record Sheets available: thin Mylar® sheets, of same size and scale factor as attenuator display, attach to window with self-contained adhesive and can be used to record position of dots in window with china- or glass-marking pencil or crayon.

Available: 1560-P40 and -P42 PREAMPLIFIERS, 1566 MULTI-CHANNEL AMPLIFIER (input scanner).

Power: 100 to 125 and 200 to 250 V, 50-60 Hz, 17 W.

Mechanical: Bench or rack models. **DIMENSIONS** (w×h×d): Bench, 19.75×9.13×12.25 in. (502×232×311 mm); rack, 19×8.75×12.25 in. (483×222×311 mm). **WEIGHT:** Bench, 49 lb (23 kg) net, 56 lb (27 kg) shipping; rack, 39 lb (18 kg) net, 47 lb (22 kg) shipping.

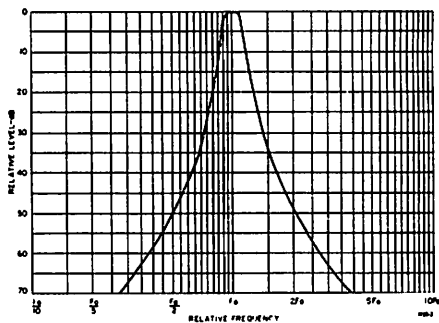

| Description | Catalog Number | |
|-------------------------------|----------------|-------------|
| 1925 MultiFilter** | | |
| One-Third-Octave Bands | Bench | Rack |
| 25 Hz to 20 kHz | 1925-9700 | 1925-9701 |
| 12.5 Hz to 10 kHz | 1925-9702 | 1925-9703 |
| 3.15 Hz to 2.5 kHz | 1925-9704 | 1925-9705 |
| 100 Hz to 80 kHz | 1925-9706 | 1925-9707 |

*Registered trademark of E.I. du Pont de Nemours and Co. Inc.

**Custom combinations of 1/3-octave filters between 3.15 Hz and 80 kHz available on special orders.

1564-A Sound and Vibration Analyzer

- 2.5 Hz to 25 kHz
- 2 bandwidths: 1/3- and 1/10-octave
- use direct from microphone or vibration pickup
- ac or portable battery operation
- automatic spectrum plots with 1521 recorder

The 1564-A Sound and Vibration Analyzer is designed primarily for measuring the amplitude and frequency of the components of complex sound and vibration spectra. Its 1/3-octave (23%) and 1/10-octave (7%) noise bandwidths provide the flexibility needed for analysis of both the noise and its causes.

Input sources The high input impedance of the analyzer permits direct connection of piezoelectric transducers for measuring sound pressures from 44 to 150 dB re 20 μ Pa and acceleration from 0.0007 g to 100 g.

The 1560-P42 and 1560-P40 Preamplifiers are available to extend the full scale sensitivity of the analyzer by 20 dB (10:1) and to allow use of the transducer at the end of a long extension cable. Alternatively, for higher sensitivity, the analyzer can be driven from a sound-level meter or vibration meter.

Automatic analysis Automatic range switching is provided so that the 1521-B Graphic Level Recorder can record automatically the spectrum of a signal under analysis. The combination of analyzer and recorder is available as the 1911-A Recording Sound and Vibration Analyzer for continuous spectrum plots. This combination is particularly well suited to measurements in accordance with MIL Standard 740B.

Noise filter The analyzer can be used in conjunction with the 1390-B, 1381, or 1382 random-noise generators for transfer and reverberation measurements using 1/3- or 1/10-octave bands of random noise.

Description The 1564-A consists of a high impedance amplifier, a continuously tunable filter having a noise bandwidth of either 1/3 or 1/10 octave, an output amplifier, and a meter. The center frequency of the filter is continuously adjustable. An all-pass, or flat, characteristic permits measurement of the over-all signal amplitude.

SPECIFICATIONS

Frequency: RANGE: 2.5 Hz to 25 kHz in four decade ranges. DIAL CALIBRATION: Logarithmic. ACCURACY OF CALIBRATION: $\pm 2\%$ of frequency-dial setting.

Filter Characteristics: Noise bandwidth is either 1/3 octave or 1/10 octave. One-third-octave characteristic has at least 30-dB attenuation at one-half and twice the selected frequency. One-tenth-octave characteristic has at least 40-dB attenuation at one-half and twice the selected frequency. Ultimate attenuation is 70 dB or greater for both characteristics. For both bandwidths, peak response is uniform ± 1 dB from 5 Hz to 10 kHz and ± 1.5 dB from 2.5 Hz to 25 kHz. An all-pass, or flat, characteristic is also included.

Detector Characteristics: Rms with three averaging times. Faster two speeds conform with ANSI standard for sound-level meters.



Input: IMPEDANCE: 25 M Ω in parallel with 80 pF (independent of attenuator setting). VOLTAGE RANGE: 0.3 mV to 30 V full scale in 10-dB steps. MICROPHONE: The 1560-P42 or 1560-P40 Preamplifiers are recommended.

Output: VOLTAGE: At least 1.0 V open circuit, when meter reads full scale. IMPEDANCE: 6000 Ω . Any load can be connected. METER: Three scales, 0 to 3 V; 0 to 10 V; -6 to + 10 dB.

Recording Analyzer: Automatic range switching at the end of each frequency decade allows convenient continuous recording of spectra with the 1521-B Graphic Level Recorder.

Calibration: Built-in, feedback-type calibration system permits amplitude calibration at any frequency.

Available: 1560-P52, -P53 Vibration Pickups, 1560-P40 and -P42 Preamplifiers (power for preamp available at input connector).

Power: Operates from 105 to 125 or 210 to 230 V, 50-60 Hz, or from nickel-cadmium battery supplied. Battery provides 25 h of operation when fully charged and requires 14 h for charging.

Mechanical: Flip-Tilt case and rack mount. DIMENSIONS (wxhxd): Portable, 10.25x8.13x8 in. (260x206x203 mm); rack, 19x10.5x5.6 in. (482x267x152 mm). WEIGHT: Portable, 15 lb (7 kg) net, 17 lb (8 kg) shipping; rack, 16 lb (8 kg) net, 28 lb (13 kg) shipping.

| Description | Catalog Number |
|-------------------------------------|----------------|
| 1564-A Sound and Vibration Analyzer | |
| Portable Model, 115 V | 1564-9701 |
| Rack Model, 115 V | 1564-9820 |
| Portable Model, 230 V | 1564-9702 |
| Rack Model, 230 V | 1564-9821 |
| Replacement Battery | 8410-0410 |

Patent Number 3,012,197.

1568-A Wave Analyzer

- 20 Hz to 20 kHz
- 1% constant-percentage bandwidth
- portable, battery-operated
- 85-dB rejection

The 1568-A is an important instrument for high-resolution frequency analyses, whether for measuring vibration and noise components or the spectrum of a complex electrical signal. Good design combines the excellent filter shape of a wave analyzer with the convenient, simple operation of constant-percentage-bandwidth analyzers in a portable, low-cost instrument.

The voltage sensitivity and input impedance, adequate for most uses, can be improved to 10 microvolts full-scale and >500 megohms, respectively, by the use of a 1560-P42 Preamplifier and a 1560-P62 Power Supply.

High resolution Narrow bandwidth permits separation of closely spaced frequencies; wide dynamic range, high stop-band attenuation, and low distortion allow measurement of small components in the presence of components up to 80 dB larger. These capabilities are vital to the identification of unwanted vibration and noise components and to the measuring of discrete frequencies in complex electrical waveforms. At low frequencies, bandwidth is narrower, stability better, and calibration more accurate than those of fixed-bandwidth heterodyne wave analyzers.

The 1568 excels in such applications as

- harmonic distortion measurements at low frequencies
- harmonic analysis—1% bw yields 50 components
- detailed analysis of machinery noise and vibration
- separation of close, discrete, low frequencies

Automatic analysis In combination, the 1568-A and 1521-B Graphic Level Recorder produce spectrum plots with as much as a 70-dB recording range. Automatic range switching is included for ease and speed in making spectrum analyses.

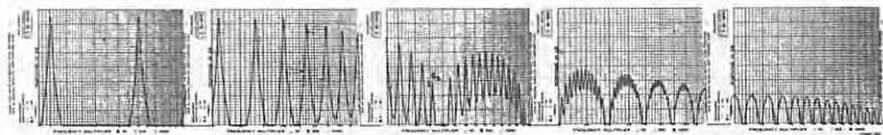

Frequency spectrum analysis of a 1.0-ms pulse at a 70-Hz repetition rate. The 1% bandwidth yields high resolution at low frequencies, shows the envelope at high frequencies.

SPECIFICATIONS

Frequency: RANGE: 20 Hz to 20 kHz in six half-decade ranges. **DIAL CALIBRATION:** Logarithmic. **ACCURACY OF FREQUENCY CALIBRATION:** 1%.

Filter Characteristics: **BANDWIDTH** between 3-dB points on selectivity curve: 1% of selected frequency. **ATTENUATION**, at 20% above and at 20% below selected frequency: > 50 dB referred to the level at the selected frequency. Attenuation at twice and at one-half the selected frequency is > 75 dB referred to the level at the selected frequency. Ultimate attenuation is > 85 dB. **UNIFORMITY** of filter peak response with tuning: ± 1 dB from 20 Hz to 6.3 kHz and ± 2 dB from 20 Hz to 20 kHz.

Input: **IMPEDANCE:** 100 kΩ. **VOLTAGE RANGE:** 100 μV to 300 V, full scale, in 3-10 series steps. **DISTORTION:** Input-circuit distortion is lower than -80 dB relative to Input-signal level.

Output: **IMPEDANCE:** 6000 Ω. Any load can be connected. **VOLTAGE:** At least one volt open circuit when meter reads full scale. **CREST-FACTOR CAPACITY:** Greater than 13 dB.

Output Meter: **CALIBRATION:** Voltage (see above) and dBm, with reference at 1 mW into 600 Ω (775 mV). **DAMPING:** 2 modes, Fast and Slow, for manual measurements of noise.

Analyzing Range: 80 dB. Components of an input signal that differ in amplitude by as much as 80 dB can be measured.

Automatic Recording: Automatic range switching is provided to allow convenient, continuous spectrum plotting when the 1521 Graphic Level Recorder is used. Medium-speed motor is recommended. Chart paper is Catalog No. 1521-9475. Frequency scale is logarithmic, 10 inches per decade; vertical scale is 4 inches for 20, 40, or 80 dB, depending on the potentiometer used in the recorder.

Calibrator: A built-in, feedback-type calibration system permits amplitude calibration at any frequency.

Supplied: Power cord; 1568-2090 Detented Knob and Dial Assembly, used to facilitate measuring the components of an input signal as a percentage or in decibels with an arbitrary voltage reference.

Available: 1560-P42 and 1560-P40 Preamplifiers; Link Unit 1521-P15, with Sprocket Kit 1521-P16 for mechanical coupling to 1521-B Graphic Level Recorder equipped with Drive Unit 1521-P10B; Chart Paper 1521-9475.

Power: 100 to 125 or 200 to 250 V, 50 to 60 Hz. 2 W for normal operation, 3.5 W for battery charging. A rechargeable nickel-cadmium battery is supplied. Battery provides about 20 hours of operation when fully charged and requires 16 hours for charging. Internal charger operates from the power line.

Mechanical: Flip-Tilt case. **DIMENSIONS (wxhxd):** With case closed, 13.25x13x8.25 in. (337x330x210 mm). **WEIGHT:** 22 lb (10 kg) net, 27 lb (13 kg) shipping.

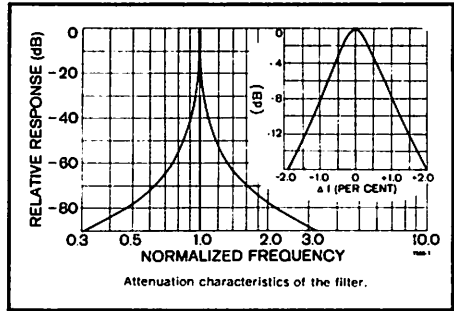

| Description | Catalog Number |
|--------------------------|----------------|
| 1568-A Wave Analyzer | 1568-9000 |
| Portable Model, 115 V ac | 1568-9010 |
| Portable Model, 230 V ac | 1568-9010 |
| Replacement Battery | 8410-0410 |

Frequency-Response and Spectrum Recorder Assembly

Several GR instruments can be used with the 1521-B Graphic Level Recorder for automatic plotting of the frequency response of a device or the frequency spectrum of (for example) acoustic noise or of a complex electrical waveform. Automatic plotting with these instruments replaces tedious point-by-point manual methods and provides much more information in the form of finer-resolution curves.

The component items can be ordered individually to convert existing equipment into fully automatic recording assemblies.

Custom assemblies of GR analysis equipment and sound and vibration instruments can be built to order to meet a variety of special requirements.

1911-A RECORDING SOUND AND VIBRATION ANALYZER

This assembly will generate continuous frequency plots of the 1/3- or 1/10-octave spectrum of sound and vibration signals over the range of 4.5 Hz to 25 kHz. Thus 1/3-octave measurements can be made in accordance with several common military and industrial noise-control specifications. While the third-octave bandwidth is convenient for testing compliance to a specification for maximum allowable noise or vibration level, the 1/10-octave bandwidth permits precise identification of individual frequency components, leading to their reduction or elimination. The analyzer will accept signals from a sound-level meter, vibration meter, or other stable amplifier, or directly from a microphone or vibration pickup. It includes a storage drawer and system power control.

SPECIFICATIONS

The 1911-A consists of the following:

- 1564-A Sound and Vibration Analyzer, rack model
- 1521-B Graphic Level Recorder with 40-dB Potentiometer (1521-9602) and medium-speed motor
- 1521-P10B Drive Unit (1521-9467)
- 1521-P15 Link Unit (1521-9615), with 16-tooth sprocket installed (standard 24-tooth sprocket also included)
- Chart Paper, 10 rolls (1521-9469), calibrated 2.5-25 normalized, logarithmic.
- Adaptor Cable, double banana to right-angle phone plug.

Available: 1560-P40 and -P42 Preamplifiers; 1961, 1962, and 1971 microphones; 80-dB potentiometer; choice of vibration pickups.

Mechanical: Assembled in cabinet. **DIMENSIONS** (w x h x d): 19.75 x 31.25 x 15.75 in. (502 x 794 x 400 mm). **WEIGHT:** 101 lb (46 kg) net, 158 lb (72 kg) shipping.

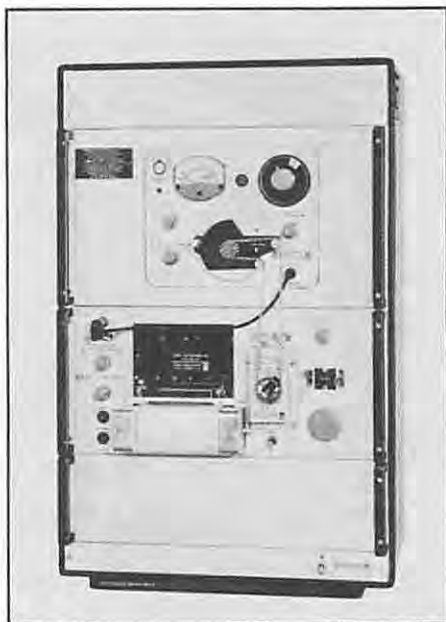

| Description | Catalog Number |
|--|----------------|
| 1911-A Recording Sound and Vibration Analyzer 60-Hz 115-V Model | 1911-9701 |

1521-B Graphic Level Recorder

- 7 Hz to 200 kHz
- 1-mV ac sensitivity—0.8-mA dc
- linear dB plot of rms ac-voltage level
- 20-, 40-, or 80-dB range
- convenient, disposable pens

Stands alone This recorder produces a permanent, reproducible strip-chart record of ac-voltage level as a function of time or of some other quantity. Record, for example, the frequency response of a device or the frequency spectrum of noise or of a complex electrical signal.

The wide range of paper speed facilitates long-period studies (such as traffic-noise) as well as short-duration-transient measurements (such as auditorium-reverberation). Writing speeds and low-frequency cutoff are selected by a single switch. The frequency response can be extended downward to 4.5 Hz with the slower writing speeds, which filter out abrupt level variations. You get a smoothed plot without loss of accuracy.

The 1521 is a solid-state, single-channel, servo-type recorder with interchangeable logarithmic potentiometers, of 20-, 40-, and 80-dB ranges, and a linear potentiometer for dc recording. The 1521 can be calibrated and relied upon for recording absolute levels as well as changes.

Or in combination This graphic level recorder can be mechanically or electrically coupled to various GR analyzers and oscillators to synchronize the frequency scale of the chart paper with the instrument's calibrated tuning-control dial. With a sound-level meter, the recorder can plot sound levels over a wide dynamic range as a function of time; the writing speed is sufficiently high for the measurement of reverberation time and other transient phenomena.

SPECIFICATIONS

AC Recording: RANGE: 40 dB full-scale with the potentiometer supplied, 20- and 80-dB potentiometers available for ac level recording. LINEARITY: $\pm 1\%$ of full-scale dB value plus a frequency error of 0.5 dB at 100 kHz and 1.5 dB at 200 kHz.

Frequency Response and Writing Speed, for AC Level Recording: High-frequency response ± 2 dB, up to 200 kHz. Low-frequency sine-wave response depends on writing speed, as shown in following table: (With the 80-dB pot, writing speed < 300 dB/s, i.e., 15 in./s.)

| Writing Speed (approx.) with 0.1-in. overshoot | | Low-Frequency Cutoff (< 1 dB down) |
|---|----------|--|
| 20 in./s | 506 mm/s | 100 Hz |
| 10 | 254 | 20 Hz |
| 3 | 76 | 7 (3 dB down at 4.5 Hz) |
| 1 | 25 | 7 (3 dB down at 4.5 Hz) |

Dc Recording: RANGE: 0.8 to 1 V (0.8 to 1.0 mA) full-scale, with zero position adjustable over full scale.



RESPONSE: 3 dB down at 8 Hz (pk-pk amplitude $< 25\%$ of full scale). LINEARITY: $\pm 1\%$ of full scale.

Resolution: $\pm 0.25\%$ of full scale.

Input: AC LEVEL RECORDING: Sensitivity is 1 mV (at 0 dB) into 10 k Ω , attenuator has 60-dB range in 10-dB steps, max limit is 100 V rms. **DETECTOR RESPONSE:** True rms, within 0.25 dB for multiple sine waves, square waves, or noise. Detector operating level is 1 V. **DC RECORDING:** Sensitivity is 0.8 or 1 V full scale, into 1 k Ω .

External Dc Reference: An external dc reference voltage of 0.5 to 1.5 V can be applied internally to correct for variations of up to 3 to 1 in the signal source of the system under test.

Paper Speeds

HIGH-SPEED MOTOR: Paper speeds of 2.5, 7.5, 25, 75 in./min. Used for high-speed-transient measurements. **MEDIUM-SPEED MOTOR:** Paper speeds of 0.5, 1.5, 5, 15 in./min. Used with analyzers and in level-vs-time plots. **LOW-SPEED MOTOR:** Paper speeds of 2.5, 7.5, 25, 75 in./h. Used for measurements from 1 hour to > 2 weeks.

Chart Paper: 4-in. recording width on 5-in. paper, 100 feet long. See separate listing of accessories.

Supplied: 40-dB potentiometer, 12 disposable pens with assorted ink colors, 1 roll of 1521-9428 chart paper, power cord, 1560-P95 Adaptor Cable (phone to double plug).

Available: Potentiometers, chart paper, pens, high-, medium-, and low-speed motors, drive and link units.

Power: 105 to 125 or 210 to 250 V, 50 or 60 Hz, 35 W.

Mechanical: Rack-bench cabinet. DIMENSIONS (wxhxd): Bench, 19x9x13.5 in. (483x229x343 mm); rack, 19x8.75x11.25 in. (483x222x286 mm). WEIGHT: 50 lb (23 kg) net, 62 lb (29 kg) shipping.

| Description | Catalog Number |
|---|----------------|
| Graphic Level Recorder, 40-dB potentiometer, high-speed motor | |
| 1521-B 60-Hz Bench Model | 1521-9802 |
| 1521-B 60-Hz Rack Model | 1521-9812 |
| Graphic Level Recorder, 40-dB potentiometer, medium-speed motor | |
| 1521-B 60-Hz Bench Model | 1521-9833 |
| 1521-B 60-Hz Rack Model | 1521-9834 |

*Other potentiometers available; see accessory pages following.

Graphic Level Recorder Accessories

Catalog
Number

Drive and Link Units for Coupling to Generator and Analyzers

1521-P10B Drive Unit

Provides mechanical-drive output from 1521-B to operate any link unit.

1521-9467

1521-P15 Link Unit

For mechanical coupling to 1564 or 1568 analyzers. Fitted with 24-tooth sprocket. Includes chain.

1521-9615

1521-P16 Sprocket Kit, contains 5 sizes of interchangeable sprockets for 1521-P15: 40, 36, 32, 20, and 16 teeth. Provides choice of scale factor in proportion to that with normal 24-sprocket. Includes chain.

| Industry Scale Factors | | | | |
|--|--------------------------|---|------------------|----------|
| Industry Standard | Scale Factor (dB/decade) | Decade Length (Inches) for 1304 Generator | Sprocket (teeth) | Pot (dB) |
| Institute of High Fidelity Manufacturers | 20 | 2.0 | 16 | 40 |
| Proposed International Standard | 25 | 2.5 | 20 | 40 |
| Electronic Industries Association | 30 | 3.0* | 24 | 40 |
| Institute of High Fidelity Manufacturers | 20 | 4.0 | 32 | 20 |
| Hearing Aid Industry | 45 | 4.5 | 36 | 40 |
| Proposed International Standard | 50 | 5.0 | 40 | 40 |
| Proposed International Standard | 50 | 5.0** | 16 | 40 |

* Chart paper available for 1304-B Beat-Frequency Audio Generator.
** Decade length applies to 1564-A Sound and Vibration Analyzer; chart paper available.

1521-9616

Chart Papers

Dimensions: 5 in. wide x 100 ft long; recording width, 4 in. (127 mm x 30.5 m; 102 mm).

| Associated Instrument | Calibration Horizontal | Vertical (Div) | Chart Length (in.) | | Catalog Number |
|--|--------------------------------------|-------------------|--------------------|-------|----------------|
| | | | Cal. | Blank | |
| 1304-B Generator | 20 Hz to 20 kHz, log | 60 | 9 | 4 1/2 | 1521-9427* |
| 1900-A Analyzer with 1900-P1 or 1900-P3 Link Units | 0-1 or 0-10 kHz, linear | 40 | 20 | 0 | 1521-9464 |
| 1900-A Analyzer with 1900-P1 Link Unit | 0-50 kHz, linear | 40 | 16 | 0 | 1521-9465 |
| 1564-A Analyzer with 1521-P15 Link Unit and 24-tooth sprocket | 2.5-25 normalized, log | 40 | 7 1/2 | 1 1/2 | 1521-9493 |
| 1564-A Analyzer with 1521-P15 Link Unit and 16-tooth sprocket (or with 1564-P1 Dial Drive continuous mode) | 2.5-25 normalized, log | 40 | 5 | 1 | 1521-9469 |
| 1564-A Analyzer with 1564-P1 Dial Drive (stepped mode) | Third-octave bands 3.15 Hz-25 kHz | 40 | 10 | 0 | 1521-9460 |
| 1568-A Analyzer with 1521-P15 Link Unit | 2-20 normalized, log | 40 | 10 | 2 | 1521-9475 |
| 1554-A Analyzer | 2.5 Hz-25 kHz, log | 40 | 18 | 3 | 1521-9463 |
| General use | Continuous 1/4-in. div. | 40 | Continuous | | 1521-9428 |

* Use with 40-dB potentiometer; has 50-dB per decade scale factor required by many testing standards, particularly the ANSI S3.8-1967, "Method of Expressing Hearing Aid Performance."

POTENTIOMETERS



| | |
|---------------------------------------|-----------|
| 1521-P1 20-dB Potentiometer | 1521-9601 |
| 1521-P2 40-dB Potentiometer** | 1521-9602 |
| 1521-P3 80-dB Potentiometer | 1521-9603 |
| 1521-P4 Linear Potentiometer (for dc) | 1521-9604 |

**Normally supplied with the recorder

OPTIONAL MOTORS

High Speed Motors Used for high-speed-transient measurements and with 1304 Beat-Frequency Audio Generator. Not for use with 1564-A and 1568 analyzers.

Medium-Speed Motors Used with analyzers and in level vs-time plots; must be used with 1564-P1 Dial Drive.

Low-Speed Motors Used for level-vs-time measurements 1-24 hours.

| | | |
|--|-----------------|-----------|
| 1521-P19 (for 60-Hz supply) normally supplied in recorder † | 2.5-75 in./min. | 1521-9619 |
| 1521-P23 (for 60-Hz supply) | 0.5-15 in./min | 1521-9623 |
| 1521-P20B (for 60-Hz supply) | 2.5-75 in./h | 1521-9513 |

†Recorder can be supplied with high- or medium-speed motor installed.

fastrak® PEN SETS and CONVERSION KIT

The pen used in the 1521-B recorder combines ink reservoir and writing point in a single disposable unit, eliminates refilling. Each cartridge has about twice the life of one old-style pen refill and can outlast three rolls of chart paper. The pen consists of a sealed plastic cartridge and with a fiber plastic point that requires only about 2 grams of force to operate properly.

The pens are available with red, green, and blue ink and are supplied in sets of four pens. A set of assorted colors is included with the recorder and with the conversion kit.

For converting older 1521-A and 1521-B recorders to use the improved pen, a kit is available that contains a pen holder, set of 12 assorted-color pens, and conversion instructions.

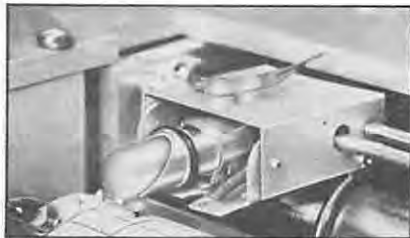

| | |
|---|-----------|
| fastrak® Marker Set, Red | 1522-9614 |
| fastrak® Marker Set, Green | 1522-9615 |
| fastrak® Marker Set, Blue | 1522-9616 |
| fastrak® Recorder Marker Conversion Kit | 1521-9439 |

1523 Graphic Level Recorder

An excellent recorder with plug-in modules for:

- Level recordings
 - frequency-response measurements
 - narrow-band wave analysis
 - fast plots of real-time analyzer output
- 1-Hz to 500-kHz frequency range
 - 100- μ V sensitivity
 - up to 100-dB dynamic range
 - up to 0.1-dB linearity
 - 4 recorders in one with plug-in versatility
 - remotely programmable—a systems natural

Automatic measurements—simply and graphically. The 1523 is not just another recorder; it is a measurement center. It incorporates the latest refinements of the recorder field with those of the sweep-oscillator and sound-analyzer fields and does so in one instrument that eliminates the usual bother of trying to keep everything synchronized. Simply connect your signal or device, set up the desired measurement conditions, and push a button—the 1523 does the rest, automatically and without constant attention or control manipulation.

Narrow-band wave analysis for

- product-noise reduction programs
- spectrum-signature work
- vibration studies
- preventive maintenance programs
- distortion measurement
- network analysis

The 1523-P4 Wave Analyzer plug-in gives you the capability to perform high-resolution spectral analysis, swept-frequency analysis with a tuned detector, and amplitude-vs-time measurements at selected frequencies.

The 1523-P4 provides analysis bandwidths of 10 Hz and 100 Hz and an all-pass mode covering the range from 10 Hz to 80 kHz. Most signals can be handled without pre-amplification, because the analyzer will accommodate inputs over a 140-dB range (3 μ V to 30 V), with capabilities to detect and display any 80-dB portion.

The analyzer conveniently provides two frequency display modes. A logarithmic display with 2.0-, 2.5- and 5.0-inch decades and a linear display with scale factors of 50 Hz, 500 Hz, and 5 kHz per inch. The logarithmic mode is useful when you use the tracking analyzer feature for network measurements or plotting spectra over a wide frequency range. The linear mode is most useful for

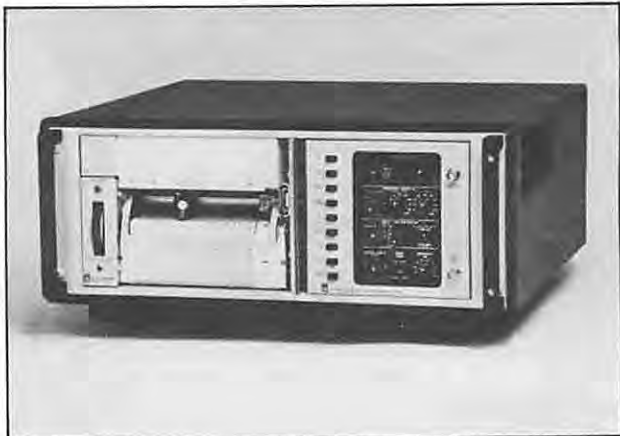

obtaining a detailed analysis over a narrower frequency range. For maximum versatility, this analyzer has controls for setting both the analysis start and stop points anywhere within the 10 Hz-to-80 kHz range.

Through the use of the plug-in approach, GR offers you two instruments—a graphic-level recorder and a wave analyzer—in a single coordinated package, capable of handling an entire measurement requirement from data acquisition and processing to hard-copy data recording. Additionally, the plug-in approach accommodates present needs while allowing for economical future expansion with other GR plug-ins.

Simple response measurements for

- filter and network response testing
- loudspeaker, amplifier, and tape-recorder evaluation
- performance tests for microphones, hydrophones, and hearing aids
- general medical and educational applications

With the 1523-P2 Sweep Oscillator plug-in, which incorporates a sweep oscillator, your recorder produces frequency-response recordings at the push of a button. You can set the oscillator to sweep the full 1-Hz to 500-kHz range, or various portions of it, at output levels continuously adjustable from 500 μ V to 5 V behind 600 Ω . A unique and versatile constant-Q mode of operation can be selected to speed the recording in many applications by increasing the sweep rate automatically as the frequency increases. Under many conditions, recordings can be made in the constant-Q mode in $\frac{1}{2}$ to $\frac{1}{3}$ the time normally required.

The accuracy and stability of the generator, plus the resolution of the recorder and the variety of chart speeds and averaging-time programs, permit precise response measurements of almost any device—performed with the ease and economy of a single instrument rather than with the clutter and confusion of two.

Versatile level recording for

- A-weighted level-vs-time recordings
- reverberation-time measurements
- general level-recording applications

Select the 1523-P1A Preamp plug-in for the best in general recorder performance. The 1523-P1A gives you a broad frequency coverage from 1 Hz to 500 kHz, a sensitivity of 100 μ V, and 18 chart speeds from as slow as 20 hours per inch to as fast as half a second per inch. Continuously adjustable attenuation from 0 to 70 dB provides the utmost in recording resolution, and a choice of nine averaging times from 10 ms to 5 s allows supreme flexibility.

DC recording capability for the 1995 or 1921 Real-Time Analyzer

- automatic plotting of real-time analysis data
- automatic spectrum overlay capability
- easy to use

The 1523-P5 DC Preamp is specifically designed to provide plots of spectra measured with the GR 1995 or 1921 Real-Time Analyzer.

The instrument simplifies and automates plotting of spectra analyzed by the real-time analyzer. Simplicity is evidenced by the absolute minimum number of controls on the 1523-P5. Logic circuits in the plug-in permit synchronized, automatic plotting, controlled from the 1995 or 1921 Real-Time Analyzer panel. Thirty $\frac{1}{2}$ -octave bands are plotted in less than 25 seconds.

It is often desirable to make more than one recording on the same chart to compare the effects of changes on the system being tested. This is automated by a "repeat chart" mode which rewinds the chart for replottin

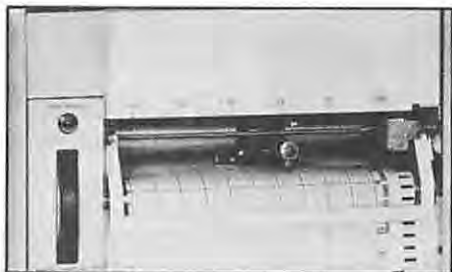

diately after the completion of a plot. Readily interchangeable pens, available in red, green, and blue, can be used to distinguish each successive spectrum.

Conveniences standard All plug-ins feature remote programmability, a variety of inputs and outputs to synchronize recorder operation with that of other instruments, and a choice of several potentiometers with dynamic ranges from 10 dB to 100 dB to tailor the instrument to your specific requirement.

For convenience, a chart take-up reel is included but the paper also can be fed out directly for immediate inspection and use. For interpretation, an event marker can be recorded by the simple push of a button at the desired time. For reliability, a stepper motor drives the chart (there are no gears or clutches to wear out, slip, or jam), and clog-free disposable pens eliminate messy refilling and provide clear, easily read, and skip-free traces even at the fastest writing speeds. You have a choice of colors and a choice of marker types: the *fastrak*[®] Marker for general purposes and the *Slow-Speed Marker* for particularly slow-moving records or those with much retracing over a part of the chart. GO/NO-GO limit adjustments are included to provide LO, GO, and HI electrical outputs for external alarm or control applications.

SPECIFICATIONS



with 1523-P1A Preamplifier Plug-in for level-vs-time recordings

- frequencies to 500 kHz
- 100- μ V sensitivity
- up to 100-dB dynamic range
- for A-weighted level-vs-time recordings
- 1-M Ω input impedance
- 18 chart speeds

Input: Chart 0-level can be 0 dB (100 μ V) to 70 dB; set in 10-dB steps plus a continuous vernier. This corresponds to a chart 0-level of 34 dB with the 1560-P42 Preamplifier in the X10 gain position and a -40 dB re 1 V/N/m² microphone. See Maximum Input Sensitivity under 1523 Mainframe Specifications. **MAXIMUM INPUT:** \pm 10 V pk ac to 250 kHz, \pm 5 V pk ac to 500 kHz, re dc component of \pm 350 V max. **IMPEDANCE:** 1 M Ω / 130 pF at plug-in; 3.35 k Ω \pm 1% direct to potentiometer via internal switch. **CONNECTORS:** Front and rear BNC and rear 3-pin A3 mike connector that also provides power for 1560-P40 or -P42 Preamplifier.

Input Frequency: FLAT or A-weighted selected by switch on front panel. Response in FLAT, 1 Hz to 500 kHz \pm 0.1 dB to 100 kHz, \pm 2 dB to 500 kHz, except $<$ 3 dB down at 100 kHz on 0-dB range. A-weighted response conforms to ANSI S1.4-1971 Type 1. Response uniformity between FLAT and A-weighted, \pm 0.2 dB at 1 kHz. Low-frequency and crest-factor cutoffs depend on averaging times (see table).

Pen: Three modes, UP, DOWN AUTO. AUTO may be either internal automatic program or remote control of pen position. UP and DOWN positions override remote programming.

Recording: **CHART SPEED:** 0.5 s/in. to 20 h/in., in 18 ranges of 0.5, 1, 2, 5, 10, and 20 h, min, or s/in., plus fast scan of 2 in./s and slow scan of 2 in./min.; all synchronized to line frequency. **RESET:** Advances at fast scan rate to start of new chart or return to start of present chart as selected by toggle switch. **AVERAGING TIMES:** 10 ms to 5 s in 9 ranges, all remotely programmable. Sinusoidal low-frequency cutoff ($<$ 1 dB down) and fundamental cutoff for 20-dB crest factor depend on averaging times as follows:

| Avg Time | Low-Frequency Cutoff | | Avg Time | Low-Frequency Cutoff | |
|----------|----------------------|-------------------|----------|----------------------|-------------------|
| | Sinusoidal | Full Crest Factor | | Sinusoidal | Full Crest Factor |
| 10 ms | 400 Hz | 1 kHz | 500 ms | 2 Hz | 8 Hz |
| 20 ms | 100 Hz | 500 Hz | 1 s | 1 Hz | 3.5 Hz |
| 50 ms | 20 Hz | 120 Hz | 2 s | $<$ 1 Hz | 1.5 Hz |
| 100 ms | 10 Hz | 35 Hz | 5 s | $<$ 1 Hz | 1 Hz |
| 200 ms | 5 Hz | 16 Hz | | | |



with 1523-P2 Sweep Oscillator Plug-in contains sweep generator for level-vs-frequency recordings

- frequencies to 500 kHz
- 100- μ V sensitivity
- up to 100-dB dynamic range
- 1-M Ω input impedance

Input: Chart 0-level can be 0 dB (100 μ V) to 70 dB; set in 10-dB steps. See also Maximum Input Sensitivity under 1523 Mainframe Specifications. **MAXIMUM INPUT:** \pm 10 V pk ac to 500 kHz, re dc component of \pm 40 V max. **IMPEDANCE:** 1 M Ω / 130 pF at plug-in; 3.35 k Ω \pm 1% direct to potentiometer via internal switch. **CONNECTORS:** Front and rear BNC and rear 3-pin A3 mike connector that also provides power for 1560-P40 or -P42 Preamplifier.

Input Frequency: 1 Hz to 500 kHz; flat within \pm 0.1 dB to 100 kHz, within \pm 2 dB to 500 kHz, except on 0-dB range, down $<$ 3 dB at 100 kHz. Averaging times programmed automatically to avoid low-frequency cutoff; program can be inhibited by external input.

Recording: **CHART SPEED:** Automatically set by sweep time (see below) and decade length. Decade length can be set for 2, 2.5, 3, 4, 5, or 10 in./decade.

Sweep Frequency: 1 Hz to 500 kHz; automatically from lower to upper frequency. Lower frequency can be set to 1, 2, 5, 10, 20, 50, 100, or 200 Hz, 1, 10, or 100 kHz; upper frequency can be set to 10 or 100 Hz, 1, 2, 5, 10, 50, 100, 200, or 500 kHz. **ACCURACY:** \pm 1% of indicated frequency. **STABILITY:** \pm 0.05% over 10 min, \pm 0.25% over 24 h; after 30-min warmup. **SWEEP TIME:** 5 s to 200 ks/decade in 5, 10, 20 sequence; or manual sweep. Averaging time decreases with frequency as follows: 2 s from 1 to 10 Hz, 200 ms from 10 to 100 Hz, 50 ms from 100 Hz to 100 kHz, and 20 ms from 100 to 500 kHz. **SWEEP RESOLUTION:** 3000 discrete logarithmically scaled steps per decade (0.08% step). **SWEEP VOLTAGE:** Dc output proportional to log of swept frequency available at rear connector.

Sweep Amplitude: 500 μ V to 5 V rms into open circuit behind 600 Ω . $>$ 10 mW into 600 Ω , available at front BNC connector; set in four decade ranges of 5 mV to 5 V full-scale open-circuit plus continuous vernier; flat within \pm 0.1 dB to 100 kHz, within \pm 1 dB to 500 kHz. **DISTORTION:** $<$ 0.2% from 1 Hz to 100 kHz with any linear load. **HUM:** $<$ 0.03%. **SPURIOUS** (discrete non-harmonic): $<$ 55 dB. **NOISE:** $>$ 60 dB below carrier in 100-kHz bandwidth.



with 1523-P4 Wave Analyzer Plug-in
for detailed noise and vibration analysis

- 80-dB dynamic range
- Tracking output
- Linear and log frequency displays
- 10 Hz-to-80 kHz analysis range

Main Input: Chart 0-level can be -30 dB (3.16 μ V) to + 50 dB; set in 10-dB steps supplemented by a 12-dB continuous vernier. **TOTAL MEASUREMENT RANGE:** 140 dB (3.16 μ V to 31.6 V). **DYNAMIC RANGE:** 80 dB, without changing attenuators, may be displayed with the 100-dB potentiometer. **MAXIMUM INPUT:** 30 V rms to 80 kHz, re dc component of \pm 50 V Max. **INPUT OVERLOAD:** Detected by peak monitor and indicated on front panel. **IMPEDANCE:** 1M Ω /30 pF. **CONNECTORS:** Front and rear BNC and rear 3-pin A3 mike connector that also provides power for 1560-P40 or -P42 Preamplifier. **ACCURACY OF RECORDED LEVEL:** \pm 0.5 dB below 10 kHz, \pm 1 dB above (with 50-dB pot).

Analyzer Characteristics: **FREQUENCY:** 10 Hz to 80 kHz. **SWEEP RANGE:** 10 Hz to 10 kHz (10-Hz bandwidth); start and stop frequencies each set by 4-position switch and 10-turn dial. **BANDWIDTH:** 10 Hz, 100 Hz, and "all pass," switch selected. **PASS-BAND SHAPES:** 3-dB Bandwidth = 10 ± 1 Hz, 60-dB bandwidth \leq 60 Hz, 80-dB bandwidth \leq 120 Hz; 3-dB bandwidth = 100 ± 10 Hz, 60-dB bandwidth \leq 400 Hz, 80-dB bandwidth \leq 800 Hz. **ACCURACY OF RECORDED FREQUENCY:** \pm 2% or \pm 5 Hz, whichever is greater. **STABILITY:** (After 30-min warmup) \pm 0.05% (10 min), \pm 0.25% (24 h). **DISTORTION:** Internally generated distortion and hum products \geq 75 dB below full scale. **NOISE:** $<$ 1 μ V in a 10-Hz bandwidth. **IMAGE REJECTION:** \geq 80 dB (100 to 180 kHz). **I-F REJECTION:** 80 dB (50 kHz).

Analysis Modes: **AUTOMATIC:** Linear sweep between start and stop frequency settings with automatic decade ranging. Analysis rates are 100, 50, 10, 5, 1, 0.5 and 0.1 Hz/s. Chart-scale factors of 50, 500 or 5000 Hz/in. Logarithmic sweep over single or multiple decades with automatic decade ranging provides the following types of analysis: (a) 100, 50, 10, 5, 1, 0.5, 0.1 Hz/s and (b) 5, 10, 50, 100, 500 s/decade. Chart-scale factors are 2.0, 2.5, and 5.0 in./decade. Sweep rate, automatically controlled. Averaging time and pen lift, also automatically controlled unless overridden by remote control. **MANUAL:** Frequency may be manually set or swept with START fre-

quency control and range multiplier. **LEVEL vs TIME:** Analyzer may be set manually to any frequency or all pass and level recorded vs time.

Secondary Inputs: Remote control by switch or DTL/TTL ground closures of numerous factors such as pen lift, chart scan, run, stop, averaging time, event markers, etc.

Tracking Output: **FREQUENCY:** Follows analyzer center frequency. **LEVEL:** 1 V across 600 Ω (or less, by manual control). **DISTORTION:** $<$ 0.2%.

Other Outputs: **I-F:** Filtered signal at 50 kHz, amplitude proportional to analyzer output. **RETRANSMITTING:** DC voltage proportional to pen excursion. **SWEEP:** DC voltage proportional to analyzer frequency. **DIGITAL:** Signals indicating system status, such as pen lift, chart direction and rate, run, stop, averaging time, limits, etc.



with 1523-P5 DC Preamplifier Plug-in

for fast plots of 1995 or 1921 Real-Time Analyzer output

Input: **VOLTAGE:** 0 to 1 V dc \pm 10% can be calibrated to produce 5.00 in. or 12.0 cm deflection on 1523 Level Recorder equipped with 1523-9625 Potentiometer. **IMPEDANCE:** 10 k Ω . **MAX SAFE INPUT VOLTAGE:** \pm 15 V peak.

Recording: With the 1523-9625 potentiometer, a linear plot is produced which matches the 60-dB display range of the 1921 Real-Time Analyzers or the 50-dB display range of the 1995.

Over-all System Accuracy: \pm 1.2% of 5-in. full-scale deflection, when end points are calibrated, including -P5 log conformity, recorder deadband, and potentiometer linearity. **NOTE:** This represents 0.75 dB for 60-dB full-scale display.

Speed: In PLOT mode, paper moves at 2 in./s; 500 ms dwell at beginning of each channel. Draws 30-band plot, including reset to new chart, in less than 25 s.

Control: PLOT is initiated remotely from the Real-Time Analyzer. Termination of PLOT produces automatic RESET. RESET may also be initiated by front-panel control. Reset direction is controlled by RESET MODE toggle switch. Paper may be scanned at 2 in./s using FAST FORWARD and FAST REVERSE. Pen may be UP, DOWN, or AUTO. PEN AUTO lowers pen automatically during PLOT, otherwise raises pen. Two calibrate potentiometers provide full-scale and bottom-scale calibration. Controls are non-interactive if bottom-scale calibration is done first.

MAINFRAME SPECIFICATIONS

Dynamic Range: Up to 100 dB, depending on potentiometer. **POTENTIOMETERS:** 5 available, all easily interchanged and all with 5-in. scales except for 60 dB which has 12-cm scale, 10 dB (with ± 0.1 -dB linearity); 25 dB (± 0.15 dB), 50 dB (± 0.25 dB), recommended for general use; 60 dB (± 0.3 dB), for use with 1523-P3 only; and 100 dB (± 0.5 dB). **MAXIMUM INPUT SENSITIVITY:** 100 μ V rms for averaging times 0.1 s or greater, 1 mV rms for averaging times <0.1 s; except for 10-dB pot, max sensitivity 1 mV; minimum averaging time 50 ms. **DEAD BAND:** $\pm 0.15\%$ of full scale; except $\pm 0.25\%$ with 0.01, 0.02 and 0.05 s averaging times. **DETECTION:** True rms, error ≤ 0.1 dB for 15-dB crest factor, <0.5 dB for full 20-dB crest factor for frequencies above crest-factor cutoff frequency. **NOISE:** Equivalent input noise $<40 \mu$ V rms. **RETRANSMITTING POTENTIOMETER:** Provides dc output voltage, proportional to ac input, of 0 to 10.4 V dc (2 V/in. of pen deflection).

Pen Control: Pushbutton switches or external DTL or TTL signals control pen position (up, down, or automatically positioned). Pen status is also indicated by DTL outputs.

Chart Control: Pushbutton switches or external DTL or TTL ground closures start or stop recording, reset paper to start of same chart or advance it to start of next chart, and provide fast forward or reverse. Switch settings are also indicated by DTL outputs. **CHART SPEED** (see Chart Speed under individual plug-in headings): Can be externally programmed. **MOTOR:** Stepper motor moves paper in 0.0067-in. increments (0.17 mm) at rates up to 300 increments per second (2 in./s). Pulse supplied by internal clock or by external DTL or TTL input at rates of ≤ 300 pps. Pulses also available as an output to synchronize other recorders. There is exactly one increment for each pulse. **PHOTOCELL:** DTL ground-closure output corresponds to black marks printed on paper.

Limits and Event Markers: **LIMITS:** 3 DTL outputs provide HI, GO, and LO continuous indications of the recording level vs 2 adjustable limits. **EVENT MARKERS:** 2 pens; pushbutton switch controls one pen to mark selected events on paper; external DTL or TTL signal activates either or both pens. (These markers act more like "rubber stamps" than "pens.")

Interface: All plug-in pushbutton-control functions can be remotely indicated or controlled; other controls cannot except for Chart Speed and Averaging Time controls on -P1 and -P2 and Sweep Time Per Decade on -P2. Levels are standard DTL or TTL, i.e., "low" is closure to ground or 0 to +0.5 V; "high" is +3.5 to +5.0 V. Logic-circuit input and output connections are available at 2 double 19-pin etched-board terminals, at rear of main frame, when plug-in is installed.

Supplied: 3-ft BNC-terminated patch cord, 2 rolls of chart paper, fastrak[®] Marker Set (4 red, 4 green, 4 blue pens), Event Marker Set of 4 red and 4 black pens, 3 potentiometer contacts, 2 paper cap assemblies, 50 chart-mounting sheets, power cord; double 19-pin etched-board connec-

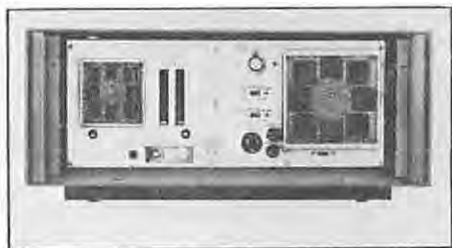

tors (1 or 2) for external programming (inputs and outputs) with each plug-in.

Power: 100 to 125 or 200 to 250 V, 50 to 60 Hz; 90 W typical, 160 W max.

Mechanical: Bench or rack models. **DIMENSIONS** (wxhxd): Bench 19.56x8.44x19.63 in. (496x214x498 mm); rack, 19x7x19.69 in (483x178x500 mm). **WEIGHT:** Bench, including plug-in, 63 lb (29 kg) net, 98 lb (45 kg) shipping; rack, including plug-in, 57 lb (26 kg) net, 92 lb (42 kg) shipping; plug-in when shipped separately, 8 lb (3.7 kg) net, 16 lb (8 kg) shipping.

| Description | Catalog Number | Ordinate Scale | Bands | Abcissa Frequencies | |
|--|----------------|----------------|-------|---------------------|------------|
| 1523 Graphic Level Recorder Mainframe without plug-in but with potentiometer noted | | 12dB/in. | 11-40 | 12.59 Hz-10 kHz | 1522-9645 |
| Potentiometer Model | | 12dB/in. | 14-43 | 25 Hz-20 kHz | 1522-9644† |
| 50 dB bench | 1523-9700 | 5dB/cm | 5-49 | 3.15 Hz-80 kHz | 1522-9654 |
| 50 dB rack | 1523-9701 | 5dB/cm | 14-43 | 25 Hz-20 kHz | 1522-9655 |
| 25 dB bench | 1523-9704 | 12dB/in. | 20-43 | 100 Hz-20 kHz | 1523-9651‡ |
| 25 dB rack | 1523-9705 | | | | |
| 60 dB bench | 1523-9706 | | | | |
| 60 dB rack | 1523-9707 | | | | |
| 60 dB bench (for use with 1523-P5 DC Pre-amplifier only) | 1523-9712 | | | | |
| 60 dB rack (for use with 1523-P5 DC Pre-amplifier only) | 1523-9713 | | | | |
| 100 dB bench | 1523-9708 | | | | |
| 100 dB rack | 1523-9709 | | | | |
| Select at least 1 of the following plug-ins | | | | | |
| 1523-P1A Pre-amplifier | 1523-9608 | | | | |
| 1523-P2 Sweep Oscillator | 1523-9602 | | | | |
| 1523-P4 Wave Analyzer | 1923-9604 | | | | |
| 1523-P5 DC Pre-amplifier (for use with 1921 or 1995 Real-Time Analyzer; requires one 1523-9625 60-dB potentiometer, which is included in 1523-9712 and -9713, and requires one 1523-9630 Cable Set for connection to 1921) | 1523-9607 | | | | |
| Cable Set | 1523-9630 | | | | |
| Potentiometers | | | | | |
| Can be ordered as options; easily interchanged to suit various requirements | | | | | |
| 10 dB Potentiometer | 1523-9620 | | | | |
| 25 dB Potentiometer | 1523-9621 | | | | |
| 50 dB Potentiometer | 1523-9622 | | | | |
| 60 dB Potentiometer (used only with 1523-P3) | 1523-9623 | | | | |
| 60 dB Potentiometer (used only with 1523-P5) | 1523-9623 | | | | |
| 100 dB Potentiometer | 1523-9624 | | | | |
| Other Recorder Accessories | | | | | |
| Event-Marker Sets, 4 black and 4 red pens | 1522-9612 | | | | |
| Mounting Sheets, 8½ x 11 in. sheets with adhesive strips to mount charts for filing in 3-ring notebooks, 50 sheets per pack | 1522-9639 | | | | |
| Isotrak® Marker Sets (general purpose) | | | | | |
| Set of 4 RED pens | 1522-9614 | | | | |
| Set of 4 GREEN pens | 1522-9615 | | | | |
| Set of 4 BLUE pens | 1522-9616 | | | | |
| Slow-Speed Marker Sets | | | | | |
| Set of 4 RED pens | 1522-9634 | | | | |
| Chart Paper | | | | | |
| Chart Paper, 140-ft rolls of 6.63-in. wide paper with 5 in. vertical chart of 50 div (except 1523-9646 which has 12-cm vertical chart area of 60 div); including timing marks for proper synchronization. | | | | | |
| FOR 1523-P1A PREAMPLIFIER: | | | | | |
| Linear, continuous scale of 0.2 in. per div | 1523-9641 | | | | |
| FOR 1523-P2 SWEEP OSCILLATOR: | | | | | |
| 3½ 3-in. decades, starts at 10, ends at 20 k | 1523-9650 | | | | |
| 5½ 2.5-in. decades, starts at 1, ends at 500 k | 1523-9652 | | | | |
| 3½ 2.5 in. decades, starts at 1, ends at 2 k | 1523-9651 | | | | |
| 3.5-in. decades, starts at 1 ends at 1 k | 1523-9652 | | | | |
| FOR 1523-P3 STEPPED ½-OCTAVE BAND ANALYZER: | | | | | |
| 3½ 2.5-in. decades, starts at 1, ends at 2 k | 1523-9640 | | | | |
| 3½ 5-cm decades, starts at 1, ends at 2 k* | 1523-9646 | | | | |
| FOR 1523-P4 WAVE ANALYZER: | | | | | |
| Linear, continuous scale of 0.2-in. per div | 1523-9660 | | | | |
| 3½ 2.5-in. decades, starts at 1, ends at 2 k | 1523-9661 | | | | |
| 3 5-in. decades, starts at 1, ends at 1 k | 1523-9662 | | | | |
| Linear, labeled frequency scale, 2 decades, 0.2-in. per div | 1523-9664 | | | | |
| FOR 1523-P5 DC PREAMPLIFIER: | | | | | |
| Ideal for use with 1921 Real-Time Analyzer, 25-dB/decade scale factors. Inch-ruled charts have 2.06-in/decade abscissa, centimeter-ruled charts have 5-cm/decade abscissa. Bands are ANSI preferred ½-octave | | | | | |

*For use only with 1523-9623 60-dB Potentiometer
†For use also with 1995 Real-Time Analyzer.
‡For use only with 1909 Real-Time Analyzer.

1985 DC Recorder

- Ideal for industrial, laboratory, and community noise recordings
- Meets ANSI and IEC Type 1 response when used with GenRad Type 1 meters
- Matched to dc outputs of GenRad sound-level meters for guess-free selection of input sensitivities/calibration
- Chart speeds from 2 cm/h to 60 cm/min
- 50-dB direct reading dynamic range
- Powered by built-in rechargeable battery for "go anywhere" operation; also operates from ac line or external dc source

Simple, accurate noise recording

The GR 1985 is a portable, lightweight, battery-powered strip-chart recorder that is designed to simplify the gathering of noise

data in permanent, hard-copy form. Compatible with GenRad sound-level meters (1933, 1981, 1982, 1983), it completes a sound-measurement/recording system that produces permanent plots of noise-level-vs-time without the usual complicated calibration procedures that often cause recording errors. The recorder may also be used with the GenRad 1945 Community Noise Analyzer.

Accuracy of the recorded data is a plus feature of the 1985 since the pen response is fast enough to meet the Type 1 requirements of ANSI and IEC fast and slow meter response when used with a GenRad Type 1 instrument.

Easy setup A front-panel switch on the 1985 allows you to select the proper input sensitivity to match the dc output of each compatible GenRad instrument. There is no need to select an input sensitivity on the 1985 that will handle the voltage range of the output from the instrument. Just set the switch for the proper instrument, adjust the zero and span adjustments, and record. The zero and span adjustments are located on the front panel for quick and easy calibration.

Guesswork eliminated The 1985 eliminates the usual guesswork about what full-scale deflection means. It has a 50-dB recording range that makes it directly compatible with GenRad wide dynamic range instruments. This means that the recorder's full scale automatically coincides with the meter's full-scale setting.

A 50-dB range is always plotted for the GenRad 1933, 1981, 1982, and 1983 sound-level meters regardless of attenuator setting. The 100-dB dynamic range of the GR 1945 Community Noise Analyzer is divided into three 50-dB ranges.

Convenient paper and chart speeds The chart paper for the 1985 comes in 20-meter lengths, is fan-folded and has provision in the margin to record all the pertinent data about the noise recording including all sound-level meter



and recorder-switch settings. Chart speeds from 2 cm/h to 60 cm/min make recording convenient for practically any application.

Use it anywhere and as a stand alone Built-in battery power lets you make recordings anywhere in the field. The rechargeable internal battery gives 8 hours of operation between 14-hour charges.

The 1985 can be used as a stand-alone recorder without a GenRad sound-level meter, powered by the internal battery, an external dc source or from an ac line. See specifications for input voltage ranges.

SPECIFICATIONS

Recorder Type: Portable, battery-powered, single-channel, strip-chart recorder with multiple speeds and with ranges matched to GenRad sound-level meters. Provides a direct reading, 50-dB dynamic range permanent recording of sound-level meter output data.

Standards: When used with the GR 1933, 1981, or 1982 Precision Sound-Level Meters or with the GR 1945 Community Noise Analyzer, the recording system meets the fast and slow meter-response requirements of ANSI S1.4-1971 Type 1, IEC Sound-Level Meter Standard 651, Type 1.

When used with the GR 1983, the recording system meets the fast and slow meter response requirements of ANSI S1.4-1971 Type 2, IEC Sound-Level Meter Standard 651, Type 2.

Recording System: METHOD OF WRITING: Cable-driven disposable cartridge with integral marking tip and ink supply. STEP RESPONSE TIME: 500 ms from bottom scale to full scale—corresponding to a 50-dB step. Response time is proportional to step size. OVERSHOOT: 1.25% (0.6 dB) typical; 2% (1 dB) maximum. PEN LIFTER: Manual front-panel lever. CHART PAPER: Z-fold,

rectilinear with 10 cm active span corresponding to 50-dB dynamic range (1-dB graduations). Chart has 5-cm folds and is 20 m long. SCALEPLATE: Removable 50-0 uniform, right-hand zero.

Measuring System: SOURCE IMPEDANCE: Up to 100 k Ω maximum. INPUT IMPEDANCE: Potentiometric on all spans. INPUT SENSITIVITIES: Seven switch-selectable spans are provided. Front-panel switch selects span for specific GenRad instrument as follows:

| GR Model No. | Span (baseline to full scale) |
|-------------------|-------------------------------|
| 1983 | 0 to + 250 mV dc |
| 1981 | 0 to + 500 mV dc |
| 1945 | |
| (30-80 dB range) | |
| 1945 | -1.2 to -3.2 V dc |
| (50-100 dB range) | |
| 1945 | -2.0 to -4.0 V dc |
| (70-120 dB range) | |
| 1982 | -2.8 to -4.8 V dc |
| 1982 | 0 to + 3.0 V dc |
| 1933 | 0 to + 5.0 V dc |

COMMON MODE POTENTIAL: ± 150 V dc maximum **COMMON MODE REJECTION:** 120 dB at 100 V dc. **MAXIMUM SAFE OVER-LOAD:** Input protected up to ± 100 V dc. **MEASUREMENT ACCURACY:** $\pm 0.5\%$ (0.25 dB) of span with maximum offset drift of 30 μ V/ $^{\circ}$ C (0.005 dB/ $^{\circ}$ C worst case with GenRad model 1983). **DEADBAND:** $\pm 0.3\%$ (0.15 dB) of chart span maximum. Included in measurement accuracy. **CONTROLS:** Zero and Span adjustments are provided on the front panel. Each allows for $\pm 10\%$ of full-scale adjustment. **SIGNAL INPUT CONNECTIONS:** (+), (-), and ground (---) banana jacks provided on the front panel.

Chart Drive System: FEED RATES: 2, 5, 10, 15, 30, and 60 cm/hour and cm/minute. **CHART SPEED ACCURACY:** $\pm 1\%$ at 23 $^{\circ}$ C $\pm 10^{\circ}$ C; $\pm 2\%$ at 0 $^{\circ}$ C to 50 $^{\circ}$ C. **CONTROLS:** Six-position feed-rate selector, Hour/Minute and chart ON/OFF switches provided on the front panel. **TRANSPORT FEATURES:** Front loading, dual-ended sprocket drive, slide-out chart accumulator, thumbwheel advance and chart tear-off bar.

Environment: TEMPERATURE: 0 to 50 $^{\circ}$ C operating and storage. HUMIDITY: 0 to 90% RH. Due to size changes in chart paper, the recorder should be calibrated at the operating humidity.

Supplied: Chart paper, 1 pack, 20m; 1 pen; rechargeable battery; battery charger; cable (15 feet); screwdriver.

Available: Chart paper, 6 packs, 20 m each; replacement pens, pack of 6; replacement battery; carrying case.

POWER REQUIREMENTS: The instrument may be powered from any one of three configurations:

Internal DC Source: 12-volt, 4.5 AH, rechargeable gelled lead-acid battery. Approximately 8-hour operation with full charge (not stalled). The stalled condition exists when the instrument is off scale in either direction. Current drain with the instrument stalled is approximately doubled. **BATTERY CONDITION INDICATOR:** Continuous



Optional carrying case

reading meter provided on the front panel. **POWER DRAIN:** Approximately 6 VA (not stalled); 10 VA maximum. Fuse protection is provided. **BATTERY CHARGER:** AC adaptor supplied. Output is approximately 12 V dc at 500 mA. Plugs into ac line and rear panel jack. Instrument is inoperative during charge period. Maximum charge time is 16 to 24 hours. Fuse protection is provided. **BATTERY LIFE:** Approximately 200 charge/discharge cycles.

External DC Source: Requires nominal 12 V dc supply (10.5 V dc at 15.0 V dc). Source connects to rear panel jack. Fuse protection is provided. **POWER DRAIN:** Approximately 6 VA (not stalled); 10 VA maximum.

External AC Source: Battery charger supplied for ac operation from 115 V $\pm 10\%$ or 230 V $\pm 10\%$, 50 or 60 Hz. Plugs into ac line and rear panel jack. **POWER DRAIN:** Approximately 12 VA (not stalled). **POWER CONTROLS:** Three-position mode switch is provided on the rear panel to select internal, external, or charging power functions. Power ON/OFF switch is provided on the front panel. **CIRCUIT PROTECTION:** Two replaceable fuses are provided on the rear panel for internal and external sources.

Mechanical: DIMENSIONS: (wxhxd); 9.75x6.13x14.63 in. (248x156x372 mm). WEIGHT: Approximately 14 lb. (6.4 kg) with battery, net.

| Description | Catalog Number |
|-----------------------------|----------------|
| 1985 DC Recorder | 1985-9700 |
| Chart Paper, 20m, pack of 6 | 1985-9600 |
| Pens, pack of 6 | 1985-9601 |
| Battery, replacement | 1985-0402 |
| Carrying Case | 1985-9603 |

1945 Community Noise Analyzer

- on-site readout of:
 - L exceedance levels, L_{dn} , and L_{eq}
- does not require tape recorders or calculators
- battery power eliminates ac line requirements
- low-cost, optional weatherproof microphone system
- weatherproof security enclosure available
- analysis durations from 10 minutes to 24 hours available
- data inhibit available

A stand-alone instrument The GR 1945 is designed to satisfy the need for a low-cost, easy-to-use community noise analyzer, without the need for tape recorders, calculators, or computers. It monitors noise levels for up to three sequential time periods having selectable durations from 30 minutes to 24 hours, or 10 minutes to 8 hours (1945-9006), and automatically computes and stores L exceedance levels, L_{dn} , and L_{eq} (optional), for each time period. Answers to the computed levels are instantly available at the push of appropriate pushbuttons. The 1945 displays the levels on an easy-to-read digital display. Sound-level measurements of existing ambient levels can also be made at the push of a button.

High reliability Unlike electro-mechanical systems that use a tape recorder for data storage, the 1945's functions are completely electronic. It does not have moving mechanical parts that are prone to wear out and which may malfunction in environmental extremes. In addition, the concern of proper recording on expensive certified tapes during widely fluctuating temperature extremes is eliminated.

The 1945 has a 100-dB dynamic range to ensure that data will not be lost during wide variations in noise levels. This capability, plus the completely automatic electronic operation of the 1945, contributes to the high reliability of its answers.

Economy and ease of use When you buy the 1945 and the microphone of your choice, you are ready to begin measuring and analyzing noise without further equipment expense. There is no need to purchase a programmable calculator, a computer, or expensive certified tape cassettes. You need only select the measurement site and follow the simple steps summarized in the instruction manual.

Security and Environmental Protection For optimum performance and protection of the 1945 at unattended measurement locations, a weatherproof microphone system and weatherproof enclosure are offered as accessories.

The 1945-9730 Weatherproof Microphone System is a complete weatherproof system for outdoor noise monitoring. It is designed to protect its integral 1560-P42 Pre-amplifier and a microphone (not included) in an outdoor environment. The windscreen system provided protects the microphone from damage and reduces the effect of wind on the noise measurement. A GR electret-condenser or ceramic microphone should be used with this system (see Specifications section).



The 1945-9640 Weatherproof Enclosure provides a weatherproof and vandal-resistant shelter for the 1945 analyzer. It is supplied with a bracket for mounting to a pole or building, and a base for free-standing operation. The enclosure is fabricated from heavy-gauge aluminum and has a tumbler lock for security.

SPECIFICATIONS

COMMUNITY NOISE ANALYZER

Sensitivity Range: Microphone input can be directly calibrated with microphone-preamplifier combinations having sensitivity of -35 to -45 dB re 1 V/N/m² (-55 to -65 dB re 1 V/ μ bar). AUX INPUT: (For use with Tape Recorder) 0.5 V rms corresponds to 120 dB.

Maximum Detected Level: 120 dB rms; provides 14-dB crest factor.

Minimum Detected Level: 5 dB above typical noise floor, using 1972-9600 or 1560-P42 Preamplifier with indicated microphone as follows:

| Microphone input with | A | C | FLAT |
|-----------------------|-------|-------|-------|
| GR 1962 Microphone | 27 dB | 30 dB | 40 dB |
| GR 1961 Microphone | 23 dB | 26 dB | 38 dB |
| GR 1971 Microphone | 25 dB | 25 dB | 29 dB |
| AUX Input | 27 dB | 26 dB | 29 dB |

Input Impedance: 20 k Ω .

Maximum Safe Input Voltage: ± 15 V peak ac, 35 V dc.

Weighting: A, C, or FLAT selected by front panel slide switch. A and C per ANSI S1.4-1971 Type 1 and IEC-651. FLAT response + 0.5, -3 dB 10 Hz to 25 kHz re 1 kHz. D weighting optionally available, consult factory.

Detector: True rms with 14-dB crest-factor capacity at 120-dB level. FAST or SLOW dynamic detection characteristic per ANSI S1.4-1971 Type 1 and IEC 651 selected by front-panel slide switch.

Statistical Analysis: RESOLUTION: 1 dB. LINEARITY: 0.25 dB. ANALYSIS DURATION: Selected by front panel switch; choices listed below. NUMBER OF SAMPLES: Function of analysis duration as follows:

| Analysis Duration | Number of Samples |
|-------------------------|-------------------|
| 4, 6, 8, 12 or 24 hours | 65528 |
| 2 or 3 hours | 32764 |
| 1 hour | 16382 |
| ½ hour | 8191 |

NUMBER OF ANALYSES: One, two or three independent consecutive analyses may be selected. **L_{eq} ANALYSIS:** When the 1945 is supplied with L_{eq} option, each sample is also used to compute L_{eq}, the equivalent continuous level, over the analysis period, or L_{dn} on a 24-hour run. L_{dn} is identical to L_{eq} except that a 10-dB penalty is added to all levels from 10:00 p.m. to 7:00 a.m. L_{eq} may be enabled on 24-h run by changing internal jumper prior to analysis. **ANALYSIS TIMING:** Start of first analysis may be delayed up to 24 hours from initial set up by use of internal clock.

Display: LEVEL dB: Current sound level may be displayed digitally with 1-dB resolution before, during or after analysis. It is updated every 0.22 second. **EXCEEDANCE LEVELS:** After analysis is complete, desired exceedance levels are pushbutton selected. The following exceedance levels are available: L_{0.1}, L₁, L₂, L₅, L₁₀, L₂₀, L₅₀, L₉₀, L₉₉, L_{min}, L_{max}. Also selectable are L_{33.3}, L_{4.25}, L_{2.12}, L_{6.25}, corresponding to HUD Circular 1390.2 requirements of level exceeded 8 hours of 24, 1 hour of 24, ½ hour of 24 and ¼ hour of 8 hours. **EQUIVALENT CONTINUOUS LEVEL:** After analysis is complete, L_{eq} (or L_{dn}) is selected by pushbutton. See "L_{eq} Analysis" above.

Data Output (electrical): Remote output connector provides the following: DC OUTPUT: 4.8 V dc behind 5 kΩ corresponds to 120-dB level, output linear at 40 mV/dB over an 80 to 98-dB dynamic range (limited only by internal noise for microphone and weighting selected). **DIGITAL:** Cumulative distribution, with 1-dB resolution, available in serial form with clock for decoding. Signals to identify analysis complete and selected memory are provided. All digital signals are buffered CMOS outputs, ≈ 8V logic levels. **EXTERNAL POWER:** Input from external battery or power supply at 8-15 V, 70 mA max, allows extended operating periods. Input has polarity reversal protection.

Environmental: TEMPERATURE: -10 to + 60° C operating, -40 to + 55° C storage (batteries installed), -40 to + 75° C storage (batteries removed). HUMIDITY: 0 to 90% RH operating. VIBRATION: 0.030" excursion 10-55 Hz.



Weatherproof enclosure.

Supplied: Screwdriver to adjust microphone CAL pot, two battery packs, 8 alkaline "D" cells, plug for microphone input, cable for remote output connector, instruction sheet.

Available: 1945-9640 Weatherproof Enclosure, 1945-9730 Weatherproof Microphone System, for outdoor use. Preamplifier, electret-condenser and ceramic microphones, cables and windcreens also available.

Power: 8 "D" cells provide 75 hours' continuous operation or permit 24 hours' running time and 1 week of idling memory contents at 25° C.

Mechanical: DIMENSIONS (wxhxd): Models 1945-9700 and -9710: 8.5x10.75x9.38 in. (216x273x238 mm). WEIGHT: Model 1945-9700: 16.5 lb (7.5 kg) net; model 1945-9710: 15.5 lb (7.1 kg) net.

COMMUNITY NOISE ANALYZER (1945-9006)

Specifications per the above with the following additions:

Statistical Analysis: A front panel switch permits selection of ANALYSIS DURATIONS of ½ hour to 24 hours as



Weatherproof microphone system.

above or 10 minutes to 8 hours shown below.

| Analysis Duration | Number of Samples |
|-----------------------------|-------------------|
| 1.33, 2, 2.67, 4 or 8 hours | 65628 |
| 40 minutes or 1 hour | 32764 |
| 20 minutes | 16382 |
| 10 minutes | 8191 |

Data Inhibit: A front panel PAUSE/RUN switch may be used to manually inhibit the data from being stored in memory. While the PAUSE/RUN switch is in the PAUSE position, the run is stopped. The run will not be completed until the total selected run time has elapsed with the PAUSE/RUN switch in RUN. For example, if a 2-hour run is started at 3 p.m. and the PAUSE/RUN switch is in the PAUSE position for 30 minutes, the run will not be completed until 5:30 p.m. The PAUSE/RUN switch is useful to eliminate the effect of unrelated noises on measurement data.

WEATHERPROOF MICROPHONE SYSTEM

Gain: 1:1 or 10:1 (20 dB) \pm 0.3 dB at 25° C, slide switch selected; < \pm 0.3 dB change from that of 25° C from -30 to + 65° C.

Frequency: Measured at 1 V rms output into open circuit with 600- Ω source, -30 to + 55° C.

| | 3 Hz | 5 Hz | 20 Hz | 100 kHz | 300 kHz | 500 kHz |
|-----------|------------|--------------|---------------|------------|---------|---------|
| 1:1 gain | \pm 3 dB | \pm 1.0 dB | \pm 0.25 dB | \pm 1 dB | | |
| 10:1 gain | \pm 3 dB | \pm 1.5 dB | \pm 0.3 dB | \pm 2 dB | | |

Input Impedance: Approximately 2 G Ω in parallel with less than 6 pF. Driven shield reduces input capacitance loading for condenser microphones.

Output Impedance: Approximately 15 Ω in series with 3.3 μ F. Up to 11 V pk-pk into open circuit with 15 V supply at frequencies up to 10 kHz. Decreasing to 2 V pk-pk for 1:1 gain and 1 V pk-pk for 10:1 gain at 100 kHz. Up to 10 mA rms output (sine wave) with 1560-9575 Power Supply.

Distortion: <0.25% harmonic distortion at 1 kHz with 1 V rms into open circuit load; <1% at 10 kHz with 1 V rms into 0.1 μ F (equivalent to 2000 ft of cable).

Polarizing Voltage: + 200 V \pm 5% behind approximately 1.2 G Ω (dc source res) slide switch selected. Temperature coefficient approx + 0.1% /° C.

Noise: <3.5 μ V equivalent input noise with 390 pF source capacitance, C weighted (10-kHz effective bandwidth).

Insert Terminals: Accepts insert calibration signal. Insert resistance 10 Ω \pm 20%. Nominal loss between connector and microphone terminals <0.5 dB. Maximum insert voltage 1 V rms.

Power: + 15 to 25 V dc 1-2 mA idling (200 V polarizing supply off), 3-5 mA idling (200 V on).

Connectors: Input connector 0.460x80 thd for direct connection to microphones and adaptors. Output (signal) connector GR 4-pin shielded, (male). Supplied with 1560-2370 10-ft cable with GR 4-pin shielded (female) connector on one end and Switchcraft type A3 3-terminal connec-

tor on the other end. 1933-9601 60-ft extension cable (optional) may be connected between preamplifier output and 10-ft cable.

Environmental: WIND: 30-mph wind typically produces 65-dBA reading; 15-mph wind typically produces 55-dBA reading. RAIN: Saturation of windscreen from heavy rain typically reduces sensitivity <2 dB for frequency <20 kHz. HUMIDITY: 99% relative humidity at 50° C for a period of two weeks will not affect performance.

Supplied: Windscreen kit, desiccant cartridge, 1560-P42 Preamplifier, 10-ft cable, mast assembly.

Mechanical: DIMENSIONS (wxhxd): 5.4x23.7x3.0 in. (138x601x78 mm). WEIGHT: 4 lb (2 kg) net.

WEATHERPROOF ENCLOSURE

Environment: SOLAR TEMPERATURE RISE: Less than 10° C in still air. Typically 3° C in light variable wind, 0-5 mph. RAIN: Rainproof for wind-driven fall angle of rain less than 45° from vertical. CONDENSING MOISTURE: Provides protection to instrument for at least 24 hours' exposure to fog or dew conditions. SNOW: Provides protection from snow with wind-driven fall angle less than 45° from vertical.

Accessories Supplied: Mounting bracket assembly with bolts to secure to enclosure. Four lag screws for securing to pole, U-bolts for securing mast, key, instruction sheet.

Mechanical: DIMENSIONS (wxhxd): 13.5x16.25x13.12 in. (343x413x333 mm). WEIGHT: 19 lb (9 kg) net.

| Description | Catalog Number |
|---|------------------------------|
| 1945 Community Noise Analyser (Requires a microphone and preamplifier) | |
| With Log/Lgn option | 1945-9700 |
| Without Log/Lgn option | 1945-9710 |
| D-weighting option is available on special order | |
| Consult factory for ordering information | |
| Community Noise Analyser (same as 1945-9700/-9710 plus additional analysis durations and Data Inhibit—see specifications) | (Available on special order) |
| Weatherproof Microphone System | 1945-9730 |
| Weatherproof Enclosure | 1945-9640 |
| Microphones | |
| Select at least one of the following microphones | |
| Electret-Condenser, 1-in., random incidence | 1961-9610 |
| Electret-Condenser, 1-in., perpendicular incidence | 1961-9611 |
| Electret-Condenser, 1/2-in., random incidence | 1962-9610 |
| Electret-Condenser, 1/2-in., perpendicular incidence | 1962-9611 |
| Ceramic, 1-in. | 1971-9601 |
| 1560-P42 Preamplifier (included with 1945-9730) | |
| Weatherproof Microphone System) | 1560-9642 |
| 1972 Preamplifier/Adaptor | 1972-9600 |
| Accessories | |
| L / Lgn Board Kit (retrofit version of Log/Lgn option) | 1945-9630 |
| Windscreen Replacement Kit | 1945-9650 |
| Desiccant Kit | 1945-9600 |
| Extension Cable (10 ft) | 1933-9600 |
| Extension Cable (50 ft) | 1933-9601 |
| Extension Cable (20 ft) | 1933-9614 |
| Battery, spare, for 1945-9700, -9710, 8 required | 8410-1510 |

Electret-Condenser Microphones

The GR electret microphone is a condenser microphone with a permanently-polarized solid dielectric diaphragm. Use of a solid dielectric permits a simplified manufacturing process, and permanent polarization eliminates the need for a polarizing-voltage power supply. The net result is a high-performance laboratory-standard microphone at a moderate cost.



These microphones represent the very latest in microphone technology. They feature very uniform high-frequency performance in both flat random- and flat perpendicular-incidence versions, and are available in a variety



1961



1962

of sizes. Since polarization voltage is not required, they can be used with inexpensive preamplifiers such as GR's 1972-9600.

1961 1-inch Electret-Condenser Microphones

Frequency: Curves show typical response and guaranteed limits; individual response curve supplied with each microphone. Below 20 Hz, the microphone is typically flat ± 1 dB down to 15 Hz relative to 1-kHz level. Microphone is essentially omnidirectional.

Sensitivity Level: Nominal: 38 dB re 1 V/Pa (-58 dB re 1 V/ μ bar). Temperature Coefficient: $< \pm 0.010$ dB/ $^{\circ}$ C typically from -20 to +55 $^{\circ}$ C at 1 kHz. Maximum Sound-Pressure Level: 160 dB re 20 μ Pa absolute max.

Impedance: Nominal: 63 pF at 23 $^{\circ}$ C and 1 kHz.

Environment: -40 to +60 $^{\circ}$ C and 0 to 99% RH operating; 1-year exposure in an environment of +55 $^{\circ}$ C and 90% RH causes negligible sensitivity change.

Mechanical: Terminals: Coaxial, with 0.907-60 thread, adapted to 0.460-60 (thread per in.).

Dimensions: 0.936 \pm 0.001 in. dia x 0.670 in. long (1.060

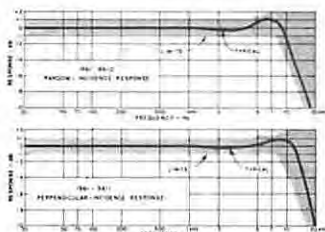

in. long with adaptor (23.77 \pm 0.025 x 17 mm). Weight: 1 oz. (28 g) net, 1 lb (450 g) shipping.

| Description | Catalog Number |
|---|----------------|
| 1961 Electret-Condenser Microphones | 1961-9610 |
| Flat random-incidence response, 1-inch | 1961-9611 |
| Flat perpendicular-incidence response, 1-inch | |

1962 1/2-inch Electret-Condenser Microphones

Frequency: Curves show typical response and guaranteed limits; individual response curve supplied with each microphone. Below 20 Hz, the microphone is typically flat ± 1 dB down to 15 Hz relative to 1-kHz level. Microphone is essentially omnidirectional.

Sensitivity Level: Nominal: -40 dB re 1 V/Pa (-60 dB re 1 V/ μ bar). Temperature Coefficient: +0.010 dB/ $^{\circ}$ C at 1 kHz. Maximum Sound-Pressure Level: 170 dB re 20 μ Pa absolute max.

Impedance: Nominal 25 pF at 23 $^{\circ}$ C and 1 kHz.

Environment: -40 to +60 $^{\circ}$ C and 0 to 99% RH operating; 1-year exposure in an environment of +55 $^{\circ}$ C and 90% RH causes negligible sensitivity change.

Mechanical: Terminals: Coaxial, with 0.460-60 thread.

Dimensions: 0.500 \pm 0.001 in. dia x 0.615 in. long (12.70 \pm 0.025 x 15.62 mm). Weight: 0.25 oz. (7 g) net, 1 lb (450 g) shipping.

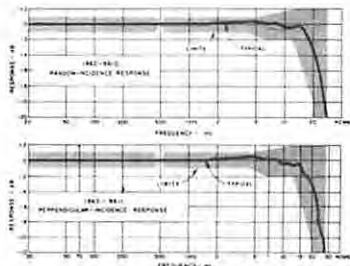

| Description | Catalog Number |
|---|----------------|
| 1962 Electret Condenser Microphones | 1962-9610 |
| Flat random-incidence response, 1/2-inch | 1962-9611 |
| Flat perpendicular-incidence response, 1/2-inch | |

Ceramic Microphones

1-inch Ceramic Microphones

Two versions of the 1-inch ceramic microphone are offered; the differences are described below. Both versions use the same microphone cartridge.

The 1971-9605 microphone comes with an adaptor base that plugs into a female three-terminal microphone connector. It mates directly with the 1560-P73 extension cable and can be mounted on a tripod in applications where the microphone will be remote from the instrument and no preamplifier is used.

The 1971-9601 comes with an adaptor that permits it to be mounted directly on the 1560-P42 or 1972-9600 preamplifiers.

Frequency: Curve shows typical random response and guaranteed limits; individual response curve supplied with each microphone. Below 20 Hz, the microphone is typically flat ± 1 dB down to 5 Hz re the 500-Hz level. Time constant of pressure-equalizing leak is typically 0.08 s with a corresponding 3-dB rolloff at 2 Hz.

Sensitivity Level: NOMINAL: -40 dB re 1 V/N/m² (-60 dB re 1 V/ μ bar); MINIMUM: -42 dB re 1 V/N/m² (-62 dB re 1 V/ μ bar). **TEMPERATURE COEFFICIENT:** ≈ -0.01 dB/ $^{\circ}$ C. **KEY SOUND-PRESSURE LEVELS:** <1% distortion at 150 dB; at -184 and +174 dB peak, microphone may fail.

Impedance: 385 pF $\pm 15\%$ at 23 $^{\circ}$ C. **TEMPERATURE COEFFICIENT of Z:** 2.2 pF/ $^{\circ}$ C from 0 to 50 $^{\circ}$ C.

Environment: **TEMPERATURE:** -40 to +60 $^{\circ}$ C operating; **HUMIDITY:** 0 to 100% RH operating.

Mechanical: **TERMINALS:** 1971-9601, Coaxial with 0.460-60 thread for mounting on 1560-P42 or 1972-9600 preamplifiers. Center terminal is signal, outer terminal (shell) is ground. 0.460-60 threaded adaptor may be removed for mounting on 1560-P40 preamplifier. 1971-9605, Microphone cartridge fitted with 3-terminal audio connector. **DIMENSIONS:** Cartridge only, 1.13 in. (29 mm) long, 0.936 \pm 0.002 in (23.7 mm \pm 50 μ m) dia; assembly, 1971-9601, 1.44 in. (36.5 mm) long; 1971-9605, 2.31 in. (59 mm) long. **WEIGHT:** 1971-9601, 1.5 oz (41 g) net, 1 lb (0.5 kg) shipping; 1971-9605, 2 oz (56.6 g) net, 1 lb (0.5 kg) shipping.

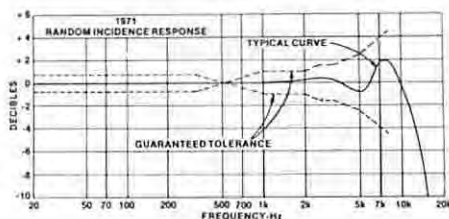

Typical performance of the 1971 Microphones with the 1560-P42 and 1972-9600 Preamplifiers (Unity Gain)

| Frequency Range | "System" Sensitivity re 1 V/N/m ² | Dynamic Range* re 20 μ N/m ² |
|------------------|--|---|
| 5 Hz to 12.5 kHz | -40 dB | 22 to 145 dB |

*A-weighted noise level to maximum sine wave signal without clipping.

| Description | Catalog Number |
|--------------------------------|----------------|
| 1971 1-inch Ceramic Microphone | 1971-9605 |
| With adaptor to mike connector | 1971-9601 |
| With adaptor to preamplifier | |

Preamplifiers

1560-P42 Preamplifier

- For electret-condenser, air-condenser, and ceramic microphones and vibration pickups

The 1560-P42 Preamplifier is a high-input impedance, low-noise preamplifier. It is particularly well suited for amplification of the output of capacitive sources, such as electret-condenser, air-condenser, and ceramic microphones and piezoelectric vibration pickups. It is an excellent choice for use with GR sound-level meters and analyzers when a long cable must be used between the microphone and the instrument. It is also a useful probe amplifier for other electrical signals where high input impedance and low noise are necessary. For example, it can increase the sensitivity and input impedance of analyzers, recorders, amplifiers, null detectors, counters, frequency meters, voltmeters, and oscilloscopes. Output from the preamplifier is through a removable 3-wire shielded cable and the required dc supply voltage is applied from one of the wires to ground.



Insert Terminals: Accepts insert calibration signal. Insert resistance $10 \Omega \pm 20\%$. Nominal loss between connector and microphone terminals < 0.5 dB. Maximum insert voltage 1 V rms.

Connectors: INPUT CONNECTOR: 0.460-60 thread for direct connection to $\frac{1}{2}$ -inch microphones and adaptors. OUTPUT (SIGNAL) CONNECTOR: (male) 4-pin shielded GR Type 1933-0410. Mates with 1560-2370 10-foot cable with Switchcraft Type A3 3-terminal microphone connector on opposite end.

Power: + 15 to + 25 Vdc, 1 to 2 mA idling (200 V off) or 3 to 5 mA idling (200 V on). Available directly from 1523, 1558, 1568, 1584, 1909, 1911, 1913, 1921, or 1925 Analyzers, 1525 Recorder, 1561 Sound-Level Meter, 1934 Noise-Exposure Meter, 1566 Multichannel Amplifier, or from 1560-P62 power supply when preamplifier is to be used with 1565 or 1551 Sound-Level Meter, 1553 Vibration Meter, and 19600 or 1910 Analyzer.

Mechanical: DIMENSIONS (less cable): 6.75 in. (170 mm) long x 0.5 (13 mm) dia. WEIGHT (with cable): 1 lb (0.5 kg) net, 3 lb (1.4 kg) shipping.

Recommended Combination of Transducers, Adaptors, and Preamplifiers

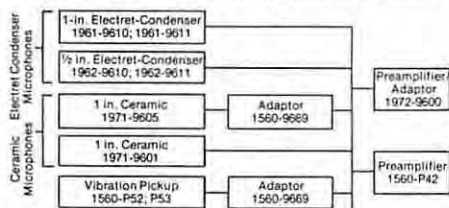

Gain: 1:1 or 10:1 (20 dB) ± 0.3 dB at 25° C, slide-switch controlled; $< \pm 0.3$ -dB gain change, from that at 25° C, from -30 to + 65° C.

Frequency Response (at 1-V rms open-circuit output behind 600 Ω , -30 to + 55° C):

| | 3 Hz | 5 Hz | 20 Hz | 100 kHz | 300 kHz | 500 kHz |
|-----------|------------|--------------|---------------|---------------|------------|---------|
| 1:1 gain | ± 3 dB | ± 1 dB | ± 0.25 dB | ± 0.25 dB | ± 1 dB | |
| 10:1 gain | ± 3 dB | ± 1.5 dB | ± 0.3 dB | ± 2 dB | | |

Impedance: INPUT: ≈ 2 G in parallel with < 6 pF; driven shield reduces input-capacitance loading for condenser microphones. OUTPUT: $\approx 15 \Omega$ in series with 3.3 μ F.

Output: SIGNAL: Up to 11 V pk-pk to 10 kHz into open circuit with 15-V supply, decreasing to 2 V pk-pk for 1:1 gain and 1 V pk-pk for 10:1 gain at 100 kHz. Up to 10-mA rms output with 1560-P62 Power Supply. POLARIZING VOLTAGE: + 200 V + 5% behind ≈ 1.2 G Ω dc source resistance; on-off slide-switch controlled; temperature coefficient $\approx 0.1\%$ /° C; frequency > 50 kHz.

Noise: < 3.5 - μ V equivalent input with 390-pF source capacitance, C-weighted, 10-kHz effective bandwidth.

Distortion: $< 0.25\%$ harmonic distortion at 1 kHz with 1-V rms into open circuit load; $< 1\%$ at 10 kHz with 1-V rms output into 0.1 μ F (equivalent to 2000 ft of cable).

| Description | Catalog Number |
|--|----------------|
| 1560-P42 Preamplifier | 1560-9642 |
| Adaptor (to most 1-in. condenser microphones) | 1560-9542 |
| Adaptor (to vibration pickups and 1-in. ceramic microphones) | 1560-9669 |

1972-9600 Preamplifier/Adaptor

The Preamplifier/Adaptor provides the high input impedance required by electret-condenser and ceramic microphones, unity voltage gain, and the capability to drive cables up to 100 feet in length. The amplifier requires a 9- to 25-volt dc power supply or normal connection to the 1560-P62 Power Supply or most any GR acoustic instrument.

The 1972-9600 has the same input connector as the 1560-P42 Preamplifier; unlike the latter, it does not provide polarization voltage for air-condenser microphones. It may be driven from the same kind of transducer as the 1560-P42 with the exception of any that require polarization voltage.

Gain: 0 dB, +0-0.25 dB, at 1 kHz.

Frequency Response: ± 1 dB, 5 Hz to 100 kHz; ± 3 dB, 3 Hz to 500 kHz (at 0.1 V rms output into an open circuit, driven from 600- Ω source).

Input Impedance: ≈ 3 pF in parallel with 1 G Ω , at low audio frequencies.

Output Impedance: Less than 20 Ω in series with 6.8 μ F.

Output: MAXIMUM VOLTAGE AVAILABLE: ≥ 10 V pk-pk, open circuit, at frequencies ≤ 100 kHz, with +15-V supply. CURRENT (available): >1 mA, pk, with +15-V supply.

Noise: <2.5 μ V equivalent input noise voltage, with 390 pF source capacitance, C weighted.

Distortion: 0.1% total harmonic distortion for frequencies ≤ 100 kHz, at 1 V rms output level, open circuit, +15-V supply.

Terminals: INPUT: Coaxial, with 0.460 x 60 thread for direct connection to most microphones (see block diagram). OUTPUT: Switchcraft type A3M microphone connector, mates with 3-wire extension cables 1560-9665, -9666, -9667.

Power: 9 to 25 V (1 mA at 9 V). Available from most GR analyzers or 1560-P62 power supply. (See list with 1560-P42.)

Mechanical: DIMENSIONS: 0.75 in. dia x 3.44 in long (19 x 87 mm). WEIGHT: 3 oz (85 g) net.

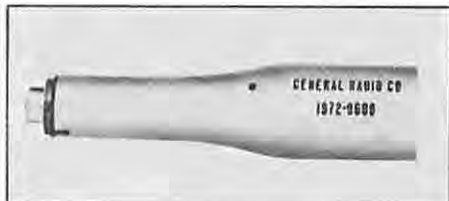

1560-P40 Preamplifier

■ For ceramic microphones and vibration pickups

The 1560-P40 Preamplifier is a high input-impedance, low noise preamplifier similar to the 1560-P42 Preamplifier except it produces no polarizing voltage and therefore cannot be used with condenser microphones.

A 1-inch ceramic microphone (1560-9570 cartridge, adaptor removed) plugs into the input end of the preamplifier case. The output from the preamplifier goes through a 3-terminal shielded connector, 1 terminal of which (with ground) brings in the required dc power.

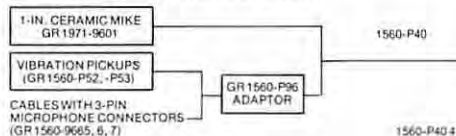

Frequency Response:

| 1:1 gain | 3 Hz | 5 Hz | 20 Hz | 250 kHz | 500 kHz |
|----------|--------|----------|-----------|-----------|----------|
| T/D gain | ± 3 dB | ± 1.5 dB | ± 0.25 dB | ± 0.25 dB | ± 1.5 dB |

Gain: 1:1 or 10:1 (20 dB) ± 0.3 dB at 25°C, slide-switch controlled; < ± 0.3-dB gain change (from that at 25°C) from -30° to + 55°C.



Impedance: INPUT: 6 pF, >500 MΩ at low audio frequencies. OUTPUT: ≈20 Ω in series with 3.3 μF at 1:1 gain, ≈100 Ω in series with 3.3 μF at 10:1 gain.

Noise: <2.5-μV equivalent input with 400-pF source capacitance. C weighted, 10-kHz effective bandwidth.

Distortion: <0.25% harmonic distortion at audio frequencies with 1 V pk-pk open-circuit output; 1% at 1 kHz with 5 V pk-pk into 0.1 μF (equivalent to 200 ft of cable); 1% at 1 kHz with 2 V pk-pk into 0.01 μF.

Available: Ceramic microphones, vibration pickups, tripod, cables, and adaptors, 1560-P96 adaptor converts input to accept 3-pin mike connectors.

Power: + 15 to + 25 V dc, 1 to 2 mA. Available from same sources as 1560-P42.

Mechanical: DIMENSIONS: 6.88 in. (175 mm) long x 1.56 in. (30 mm) dia. WEIGHT: 0.6 lb (0.3 kg) net, 3 lb (1.4 kg) shipping.

| Description | Catalog Number |
|---|----------------|
| 1560-P40 Preamplifier | 1560-9640 |
| 1560-P96 Adaptor, to microphone connector | 1560-9696 |

Power Supply

1560-P62 POWER SUPPLY Required with 1560-P40, -P42, or 1972-9600 Preamplifiers when they are used with instruments that do not include a source of power such as the 1551 and 1565 Sound-Level Meters. Also useful when long cables are to be driven at high levels and as a charger for rechargeable batteries in the 1561 Sound-Level Meter or 1952 Universal Filter.

A single front-panel control selects operating mode: OFF, CHARGE ONLY, CHARGE AND OPERATE, OPERATE ONLY, REMOTE (off or operate-only mode selected remotely by instrument such as 1561 or 1564 analyzer), and BATTERY CHECK. The batteries are easily removed by a slide-out clip and fit into the same type of holder used in the 1952 Universal Filter.

Input: 100 to 125 or 200 to 250 V, 50 to 60 Hz.

Output: 18 to 21 V dc, 15 mA max; automatic limiting protects supply and prevents deep battery discharge. **BATTERIES:** Two rechargeable Ni-Cd batteries provide up to 225 mA-hours operation at room temperature between charges. **RIPPLE:** < 5 mV rms in CHARGE-OPERATE mode. **CHARGE TIME:** 14 to 16 h for completely discharged battery, constant 22-mA battery-charging current. Rear-panel slide switch selects internal or external battery.

Interface: INPUT (from preamp): Power to, and signal from, preamplifier. Use Switchcraft type A3M micro-



phone connector. OUTPUT (to analyzer): Signal from preamplifier and remote power control. Use Switchcraft type A3F microphone connector. **ADDITIONAL OUTPUT:**

Miniature phone jack for connection to 1933 sound-level meter/analyzer and patch cable fitted with miniature phone plugs (listing follows).

Supplied: Cable to connect to 1551, 1561, 1564, etc; and cable to connect to 1561 charging terminals.

Remote Operation: With line voltage not connected, preamplifier can be set to Operate-Only mode by signal of + 15 to 25 V at 300 μA.

Environmental: TEMPERATURE: -15 to + 50°C operating.

Mechanical: Convertible Bench cabinet. DIMENSIONS (wxhxd): 8.5x3.84x5.5 in. (216x98x140 mm). WEIGHT: 3 lb (1.4 kg) net, 5 lb (2.3 kg) shipping.

1560-P62 Power Supply, Bench Model

1560-9575

Guide to Microphone System Selection

The microphones, preamplifiers and power supplies listed on the preceding pages may be put together to make complete microphone systems.

Microphone Selection First determine the frequency range and lowest sound level to be measured. Then, select a microphone that will fulfill these requirements. Note that the noise floor for each microphone will be lower if the measured signal is analyzed with full octave or narrower bandwidth filters.

Preamplifier Selection Three preamplifiers are offered. The 1560-P42 is the most versatile, as it can be used with all GR microphones and condenser microphones from other manufacturers. It can drive very long cables and provides a voltage-gain choice of 1 or 10 (0 or 20 dB).

The 1972-9600 Preamplifier/Adaptor has the same input fitting as the 1560-P42; however, the former does not have the polarization voltage capability and, therefore, cannot be used with air-condenser microphones. This

unity-voltage-gain preamplifier is recommended for driving cables up to 100 feet (30 m) long.

The 1560-P40 Preamplifier was designed for use with the 1971-9601 Microphone (with adaptor base removed). It will work well with accelerometers and other electrical inputs when used with the 1560-P96 Adaptor. This preamplifier provides a voltage-gain choice of 1 or 10 (0 or 20 dB) and may be used with cables of moderate length.

Power Supplies All the preamplifiers mentioned above require power to operate them; many GR sound measuring instruments supply it directly. (Consult the power specifications of the 1560-P42 or the specifications for the specific instrument of interest to see whether this power is supplied). If a separate power supply is required, use the 1560-P62. This should always be used (even with instruments that supply preamplifier power) if very long cables (over a few hundred feet) are to be driven, as the preamplifier power supplies built into most instruments have limited current capability.

ACCESSORIES FOR ACOUSTIC INSTRUMENTS

MICROPHONE WINDSCREENS

These microphone windscreens reduce the effects of ambient wind noise and protect the microphone diaphragm in oily, misty, or dusty environments. They attach easily to any 1-inch microphone and do not appreciably alter the sensitivity or frequency response of the microphone. The windscreens are made of reticulated polyurethane foam and can be conveniently washed if they become soiled.

Wind-Noise Reduction: 20 dB in winds \leq 30 mph.

Microphone Sensitivity Loss: 0 dB to 3 kHz, \approx 0.5 dB to 5 kHz, \approx 2 dB to 12 kHz; see curve.



Windscreens are also available for 1/2-inch microphones. Their specifications are similar to those for 1-inch microphones.

| Description | Catalog Number |
|---|----------------|
| Microphone Windscreens, 4 each per pack | |
| For 1-in. microphones | 1560-9521 |
| For 1/2-in. microphones | 1560-9522 |

TRIPOD

1560-9590 TRIPOD Versatile—accepts a variety of equipment. A 1/4-20 threaded stud fits all GR sound-level meters and electronic stroboscopes, a 1-in. sleeve accepts the 1560-P40 and 1972-9600 Preamplifiers, and a 1/2-in. sleeve accepts the 1560-P42 Preamplifier.

| | |
|--------|-----------|
| Tripod | 1560-9590 |
|--------|-----------|



EXTENSION CABLES

Preamplifier Cable Shielded 3-wire-plus-ground cable terminated in Switchcraft Type A3 3-terminal microphone connectors (male and female). For use between preamplifier output and analyzer. Mates directly with input and output connectors of 1560-P62 Power Supply and most GR acoustic instruments. Provides a wire to carry power from analyzer (for example) to preamplifier.

Net Weight: -P72E 13 oz (369 g); -F, 2.3 lb (1.1 kg).

| Description | Catalog Number |
|---|----------------|
| Preamplifier Cable | |
| 1560-P72E Extension Cable, 25 ft | 1560-9666 |
| 1560-P72F Extension Cable, 100 ft | 1560-9667 |
| Extension Cables 4-wire, for extending the 1933, 1981, and 1982 Preamplifier from the instrument case. | |
| Microphone Extension Cable, 10 ft. | 1933-9600 |
| Microphone Extension Cable, 60 ft. | 1933-9601 |
| Microphone Extension Cable, 20 ft. | 1933-9614 |

PATCH CABLES

Shielded patch cords and adapting cables, for general use. Net Weight: For 3-ft lengths, \approx 2 oz (57 g); for 2-ft lengths, \approx 1.4 oz (40 g).

Miniature-Phone Plug Adapting Cables With miniature phone plug at one end. Various versions have at the other end a double (in-line) banana plug or other regular-sized connectors, as listed.

| Description | Catalog Number |
|---|----------------|
| Miniature Phone-Plug Patch Cords | |
| 1560-P77, with Double Banana Plug, 3 ft | 1560-9677 |
| 1560-P78, with 1/4-in. Phone Plug, 3 ft | 1560-9678 |
| 1560-P79, with BNC Plug, 3 ft | 1560-9679 |
| 1560-P80, with 1/4-in. Phone Jack, 2 ft | 1560-9680 |
| Miniature Phone Plug to 1933, 1981, or 1982 input | 1933-9602 |

Phone-Plug Cables With 1/4-in. phone plug at one end. Other end, either similar or with hammerhead double-banana plug.

| Description | Catalog Number |
|---|----------------|
| 1560-P95 Adaptor Cable, Phone/Banana Plug, 3 ft | 1560-9695 |

BNC- and Banana-Plug Cables With both ends identical. One version male BNC. The other version has in-line double banana plugs.

| | |
|---|-----------|
| 776-C Patch Cord, with BNC plugs, 3 ft | 0776-9703 |
| 274-NG Patch Cord, with Double Banana Plugs, 3 ft | 0274-9660 |

ADAPTORS

1560-9669 Adaptor Adapts 1560-P42 Preamp input to Switchcraft type A3 3-pin microphone connector (female). See note, below.

1560-P96 Adaptor Converts inputs of 1560-P40 Preamp and 1565 Sound-Level Meter to A3 3-pin microphone connector (female). Note: This adaptor can be made easily by removing a part from the 1560-9669 (above).

1560-9561 Coupler/Adaptor Set Adapts 1/2, 1/4, and 1/8-in. Bruel and Kjaer air-condenser microphones to 1562 Sound-Level Calibrator.

| Adaptors | |
|--|-----------|
| Microphone Connector to Preamp | 1560-9669 |
| 1560-P96, Microphone Connector to Preamp | 1560-9696 |
| Coupler/Adaptor Set, Microphones to Calibrator | 1560-9561 |



PREAMPLIFIER ACCESSORIES

Microphone Attenuator Attenuates output of 1962 1/2-in. Electret-Condenser Microphones by either 10 or 20 dB, to allow operation at high levels.

Dummy Microphone Shielded capacitor. Used to simulate a 1962 1/2-in. Electret-Condenser Microphone to determine instrument noise floor. BNC input connector also provided to connect a signal source, simulating a sound signal. BNC shorting plug supplied.

1560-P35 Permanent-Magnet Clamp For firm holding of a vibration pickup to a ferrous metal surface.

| Preamp Accessories | |
|---|-----------|
| Microphone Attenuator, 10 dB | 1962-3200 |
| Microphone Attenuator, 20 dB | 1962-9000 |
| 1560-P9 Dummy Microphone, 35 pF (used in place of 1962-9601, -9602) | 1560-9609 |
| Dummy Microphone, 22 pF (used in place of 1962-9610, -9611) | 1962-9620 |
| 1560-P35 Permanent Magnet Clamp | 1560-9635 |

CASSETTE

Cassette, 30-minute, for use with 1935 Cassette Data Recorder.

| | |
|---------------------|-----------|
| Cassette, 30-minute | 1935-9603 |
|---------------------|-----------|

Vibration Pickups and Systems

- accessories for sound-level meters
- select for:
 - high-frequency performance
 - general application, economy

For the measurement of solid-borne vibrations the sound-level meter a vibration pickup is used in place of the microphone.

Each of these vibration pickup systems consists of a vibration pickup, a control box, and a connection cable. The vibration pickup is an inertia-operated, ceramic device, which generates a voltage proportional to the acceleration of the vibrating body. By means of integrating networks in the control box, voltages proportional to velocity and displacement can also be delivered to the sound-level meter. The desired response is selected by means of a three-position switch on the control box. Conversion data are supplied for translating the decibel

indications of the sound-level meter into the vibration parameters of displacement, velocity, and acceleration.

Type 1560-P11B

This system uses a lead-zirconate-titanate pickup. Probe and probe tips are provided and a permanent-magnet mount is also available.

Type 1560-P13

For measurements at higher frequencies than the -P11B system affords, the -P13 combination is recommended, consisting of the 1560-P53 Vibration Pickup and the 1560-P23 Control Box. A small holding magnet is included.

This system with the Type 1551-C or -B Sound-Level Meter provides the flat frequency response and low-noise operation required by MIL-STD-740 (SHIPS) for vibration measurement. (The holding magnet is not used for measurements according to that standard.)



The 1560-P118 Vibration Pickup System with the 1551-C Sound-Level Meter.

| Pickup Systems Also see 1933-9610 Vibration Integrator Systems | General Purpose 1560-P11B Vibration Pickup System | High Frequency 1560-P13 Vibration Pickup System |
|--|--|---|
| Ranges of Measurement | 0.1 to 39,000 (100 g)† | 0.3 to 390,000 (1000 g)† |
| Rms Acceleration (in./s ²) | 0.001 to 300 at 20 Hz* 100 at 60 Hz 10 at 600 Hz | 0.001 to 1000 at 20 Hz** 1000 at 60 Hz* 100 at 600 Hz |
| Rms Velocity (in./s) | 0.00003 to 1 at 30 Hz* 0.1 at 100 Hz | 0.00003 to 10 at 30 Hz* 1 at 100 Hz |
| Rms Displacement (in.) | 0.00003 to 1 at 30 Hz* 0.1 at 100 Hz | 0.00003 to 10 at 30 Hz* 1 at 100 Hz |
| Frequency Range | <p>Response characteristics for constant applied (1) acceleration, (2) velocity, and (3) displacement.</p> | |
| Net Weight of System (lb) | 1½ (0.8 kg) | 1½ (0.8 kg) |
| Shipping Weight (lb) | 5 (2.3 kg) | 5 (2.3 kg) |
| Catalog Number | 1560-9922 | 1560-9613 |
| Pickup Characteristics | 1560-P52 | 1560-P53 |
| Pickup Type Number | 1560-P52 | 1560-P53 |
| Sensitivity (mV/g), nominal | 70 | 70 |
| Temp Coeff of Sens (dB/°C) | <-0.01 | <0.02 |
| Resonant Frequency (Hz) | 3200 | 27,000 |
| Capacitance (pF) | 10,000 | 350 |
| Temperature Range (°C) | -18 to 100 | -54 to 177 |
| Relative Humidity Range (%) | 0 to 100 | 0 to 100 |
| Cable Length (ft) | 5 (1.55 m) | 8 (2.5 m) |
| Dimensions (in.) | 1½x1½x3¼ | ½ (hex) x 0.7 |
| (mm) | 42x37x15 | 15.5x18 |
| Net Weight (oz) | 1.6 (45 grams) | 1.1 (31 grams) |
| Catalog Number | 1560-9652 | 1560-9653 |
| <p>† g = acceleration of gravity. * Upper limit of displacement and velocity measurements depends upon frequency and is determined by the maximum acceleration possible before nonlinearity occurs (100 g for 1560-P11B, 1000 g for 1560-P13). ** Maximum reading of instrument.</p> | | |

1396-B Tone-Burst Generator

- fast, coherent switch for periodic waves
- dc to 2 MHz
- signal attenuated >60 dB between bursts
- length of burst: 10 μ s to 10 s, or continuous, or 1 to 129 periods of the switched signal
- or burst length controllable by separate input

The 1396-B Tone-Burst Generator fills the gap between steady-state cw testing and step-function, or pulse, testing of amplifiers, meters, etc. It is ideally suited for applications such as the test and calibration of sonar transducers and amplifiers, the measurement of distortion and transient response of amplifiers and loudspeakers, and routine testing of filters and ac meters. Still other uses are found in the measurement of room acoustics and automatic-gain-control circuits, in the synthesis of time ticks on standard-time radio transmissions, and in psychoacoustic instrumentation.

Description The 1396 acts as a switch that alternately interrupts and passes an input signal, thus chopping into bursts a sine wave, or continuous tone, applied to the input. The instrument times the burst duration and interval between bursts exactly by counting the number of cycles, or periods, of the input signal. Panel controls permit these intervals to be set to a wide range of values. The exact time at which the burst starts and stops can be controlled, thus the burst is phase-coherent with the input signal.

Alternatively, timing can be based on a separate signal, the output can be turned on continuously for alignment or calibration, or single bursts can be generated with a front-panel pushbutton. The 1396-B can also operate with nonsinusoidal or aperiodic inputs.

SPECIFICATIONS

Signal Input (signal to be switched): AMPLITUDE: ± 1 to ± 10 V pk-pk (7 V rms with 0-V dc component) for proper operation. FREQUENCY RANGE: Dc to 2 MHz. INPUT IMPEDANCE: 50 k Ω , approx.

Timing Input (signal that controls switch timing): Same specifications as Signal Input except: INPUT IMPEDANCE: 20 k Ω , approx.

Signal Output: OUTPUT ON: Replica of Signal Input at approx same voltage level; dc coupled; down 3 dB at > 1 MHz. Output current limits at > 25 mA pk, decreasing to > 15 mA at 2 MHz. Output source impedance typically 25 Ω , increasing above 0.2 MHz. Total distortion contribution < 0.3% at 1 kHz and 10 kHz. OUTPUT OFF: Input-to-output transfer (feed-through), < 10 mV (< -60 dB re full output), dc to 1 MHz, increasing above 1 MHz.

SPURIOUS OUTPUTS: Dc component and change in dc component due to on-off switching (pedestal) can be nulled with front-panel control. Output switching transients are typically 0.2 V pk-pk and 0.2 μ s in duration (120-pF load).

On-Off Timing: Timing is phase-coherent with, and controlled by, either the signal at the Signal Input connector



or a different signal applied to the Ext Timing connector. The on interval (duration of burst) and the off interval (between bursts) can be determined by cycle counting, timing, or direct external control. **CYCLE-COUNT MODE:** On and off intervals can be set independently, to be of 1, 2, 4, 8, 16, 32, 64, or 128 cycles (i.e., periods) duration or to be 2, 3, 5, 9, 17, 33, 65, or 129 cycles with + 1 switch operated. **TIMED MODE:** The on and off times can be set independently from 10 μ s to 10 s. They end at the first proper phase point of the controlling signal that occurs after the time interval set on the controls. One interval can be timed and the other counted, if desired. **SWITCHING PHASE:** For either of the above modes, the on-off switching always occurs at a phase of the controlling signal that is determined by the triggering controls. The Slope control allows triggering on either the positive or negative slope of the controlling signal and the Trigger Level control sets the level at which triggering occurs. **DIRECT EXTERNAL CONTROL:** A 10-V pulse applied to rear-panel connection will directly control switching.

Synchronizing Pulse: A dc-coupled aux output alternates between approx + 8 V (output on) and -8 V (off). **SOURCE RESISTANCE:** ≈ 0.8 k Ω for pos output and ≈ 2 k Ω for neg.

Power: 100 to 125 or 200 to 250 V, 50 to 400 Hz, 16 W.

Mechanical: Bench cabinet. DIMENSIONS (wxhxd): 8.5x5.63x10 in. (216x143x254 mm). WEIGHT: 8 lb (3.7 kg) net, 12 lb (5.5 kg) shipping.

Description

Catalog

1396-B Tone-Burst Generator
Bench Model

1396-9702

1840-A Output Power Meter

- 20 Hz to 20 kHz
- 0.1 mW to 20 W
- 0.6- Ω to 32-k Ω input impedance
- true rms reading

The 1840-A measures audio-frequency power into any desired magnitude of load impedance. Its important uses include the measurement of:

- Power output of oscillators, amplifiers, preamplifiers, transformers, transducers, and low-frequency lines.
- Output impedance, by adjustment of this load to yield maximum power indication.
- Frequency-response characteristics of amplifiers, transformers, and other audio-frequency devices.

This instrument is basically a multi-tapped audio-frequency transformer with a fixed secondary load. Its two front-panel switches connect eight identical primary windings and six secondary taps in various combinations to provide a total of 48 different primary impedances.

The maximum power rating can be extended for any given impedance with the use of a simple T-network attenuator, design data for which are supplied with the instrument.

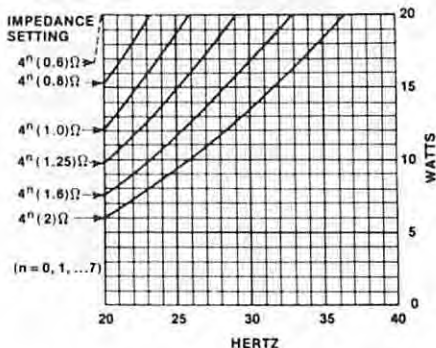
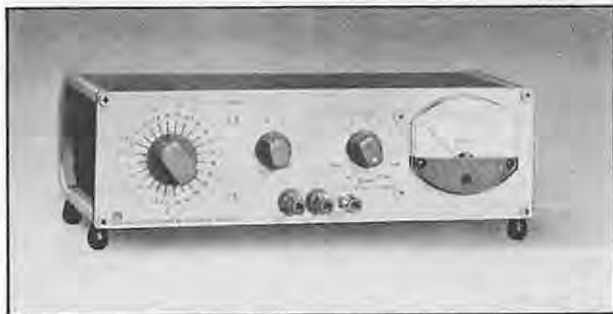

Power derating vs impedance setting and frequency. All 48 impedance settings are represented, as $n = 0, 1, 2, \dots, 7$.

SPECIFICATIONS

Power: 0.1 mW to 20 W, 40 Hz to 20 kHz. Below 40 Hz, max rating is reduced by up to 50% (at 25 Hz), depending on impedance selected. See curve. Auxiliary dB scale reads from -15 to +43 dB re 1 mW.

Impedance: 0.6 Ω to 32 k Ω in two ranges; yielding 48 individual impedances spaced approximately $\sqrt[3]{2}$ apart.

Power Accuracy:

- At 1 kHz, ± 0.3 dB;
- 50 Hz to 6 kHz, ± 0.5 dB;
- 30 Hz to 10 kHz, ± 1 dB;
- at 20 Hz, -1.5 dB max, -1 dB avg;
- at 20 kHz, -5 dB max, ± 1.5 dB avg.

Impedance Accuracy (at full-scale voltage):

- At 1 kHz, $\pm 6\%$ max, -0.5% avg;
- 70 Hz to 2.5 kHz, $\pm 7\%$;
- 2.5 kHz to 5 kHz, for $Z < 10$ k Ω , $\pm 7\%$;
- at 20 Hz, -15% max, -8% avg;
- at 20 kHz, $\pm 50\%$ max, $\pm 12\%$ avg.

Waveform Error: Meter will indicate true rms with as much as 20% second and third harmonics present in the input signal.

Mechanical: Convertible bench cabinet. DIMENSIONS (wxhxd): 12x4x8 in. (305x102x203 mm). WEIGHT: 11 lb (5 kg) net, 17 lb (8 kg) shipping. Rack-adaptor panel height, 3.5 in. (89 mm).

| Description | Catalog Number |
|---------------------------------|----------------|
| 1840-A Output Power Meter | 1840-9701 |
| 480-P212 Relay-Rack Adaptor Set | 0480-9822 |

1381 and 1382 Random-Noise Generators

GR 1381

- 2 Hz to 2, 5, or 50 kHz, Gaussian distribution
- adjustable clipping
- 3-V rms output

GR 1382

- 20 Hz to 50 kHz, Gaussian distribution
- white, pink or ANSI* spectra
- 3-V rms output, balanced, unbalanced, or floating

Predictably random The 1381 and 1382 are companion instruments that generate truly random noise from a semiconductor source. Special precautions are taken to ensure a symmetrical, Gaussian amplitude distribution. Output level is adjustable from below 3 millivolts to 3 volts rms behind a 600-ohm source impedance. Each model is constructed in a 3½-inch-high, half-rack-width cabinet, convenient for bench use and two can be mounted side-by-side in a relay rack.

Either of these noise generators can be used for simulation of noise in signal paths, as test-signal sources, or for demonstrations of statistical and correlation principles. The different features of the two offer a choice to match your needs.

Lowest frequency The 1381 generates noise that is flat down to 2 Hz and is intended for random-vibration tests and for general-purpose use in the audio and sub-audio range. The upper-frequency limit (at -3 dB) can be switched to 2, 5, or 50 kHz. The output signal can be clipped symmetrically at 2, 3, 4, or 5 times the rms amplitude.

Pink or white The 1382 generates noise in the 20-Hz to 50-kHz band and is intended for electrical, acoustical, and psycho-acoustical tests. It offers three spectra, white (flat), pink (-3 dB per octave), and ANSI (see specifications). The output can be taken balanced or unbalanced, floating or grounded.



GR 1381



GR 1382

*Formerly ASA and USASI

SPECIFICATIONS

Spectrum of 1381: SHAPES: Flat (constant energy per hertz of bandwidth) ± 1 dB from 2 Hz to half of cutoff. CUTOFF FREQUENCY (down 3 dB); 2, 5, or 50 kHz, selected by switch. SPECTRAL DENSITY, at 3-V output level and for 1-Hz bandwidth: 64, 40 and 13 mV, approx, respectively for upper cutoff frequencies of 2, 5, and 50 kHz. SLOPE of amplitude vs frequency above upper cutoff: 12 dB/octave. See graph.

Spectrum of 1382: Choice of 3 shapes. WHITE NOISE (flat spectrum, constant energy per hertz bandwidth): ± 1 dB, 20 Hz to 25 kHz, with 3-dB points at approx 10 Hz and 50 kHz; PINK NOISE (constant energy per octave bandwidth): ± 1 dB, 20 Hz to 20 kHz; or ANSI NOISE, as specified in ANSI* Standard S1.4-1961. See graph.

Waveform:

| Voltage | Gaussian Probability-Density Function | Amplitude-Density Distribution of 1381/1382 |
|---------------|---------------------------------------|---|
| 0 | 0.0796 | 0.0796 \pm 0.005 |
| $\pm \sigma$ | 0.0484 | 0.0484 \pm 0.005 |
| $\pm 2\sigma$ | 0.0108 | 0.0108 \pm 0.003 |
| $\pm 3\sigma$ | 0.000898 | 0.000898 \pm 0.0002 |
| $\pm 4\sigma$ | 0.0000274 | 0.0000274 \pm 0.00002 |

These data measured in "windows" of 0.2σ , centered on the indicated values of voltage; σ is the standard deviation or rms value of the noise voltage.

Clipping: The output of the 1381 can be clipped internally to remove the occasional wide extremes of amplitude. Clipping, if desired, is adjustable to approx 2, 3, 4, or 5σ . Such clipping has negligible effect on the spectrum or the rms amplitude.

Output: VOLTAGE: > 3 V rms max, open-circuit, for any bandwidth. CONTROL: Continuous adjustment from that level down approx 60 dB. IMPEDANCE: 600 Ω . Can be shorted without causing distortion. 1381 output is unbalanced; 1382 output is floating, can be connected balanced or unbalanced. TERMINALS: 1381 output at front-panel binding posts and rear-panel BNC connector; 1382 output at front-panel binding posts and rear-panel jacks for double plugs.

Supplied: Power cord, rack-mounting hardware with rack models.

Power: 100 to 125 or 200 to 250 V, 50 to 400 Hz, 6 W.

Mechanical: Convertible bench cabinet. DIMENSIONS (wxhxd): Bench, 8.5x3.87x9.87 in. (216x88x250 mm); rack, 19x3.5x9 in. (483x89x229 mm). WEIGHT: 7 lb (3.2 kg) net, 10 lb (4.6 kg) shipping.

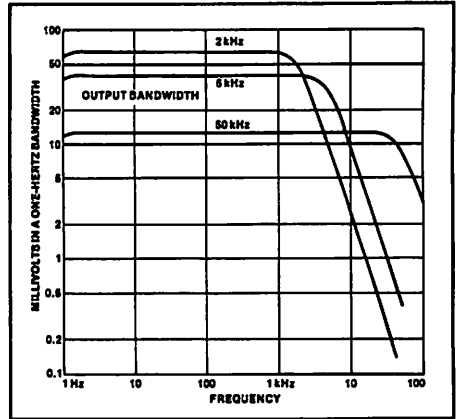

Type 1381

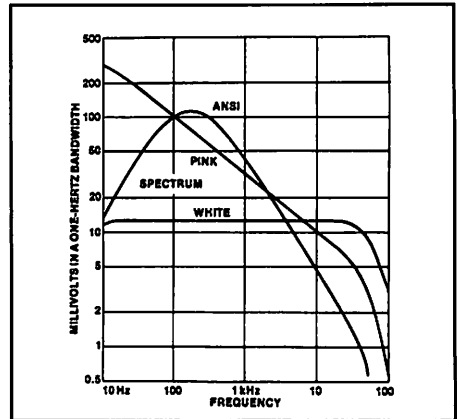

Type 1382

| Description | Catalog Number |
|-------------------------------|----------------|
| Random-Noise Generator | |
| 1381 (2 Hz to 50 kHz), Bench | 1381-6700 |
| 1381 (2 Hz to 50 kHz), Rack | 1381-6701 |
| 1382 (20 Hz to 50 kHz), Bench | 1382-6700 |
| 1382 (20 Hz to 50 kHz), Rack | 1382-6701 |

*Formerly ASA and USA SI

1390-B Random-Noise Generator

- 5 Hz to 5 MHz
- 30 μ V to 3 V
- ± 1 -dB audio-spectrum-level uniformity

This instrument generates wide-band noise of uniform spectrum level, particularly useful for noise and vibration testing in electrical and mechanical systems. The noise output of a gas-discharge tube is amplified and shaped with low-pass filters to provide wide spectral ranges with upper cutoff frequencies of 20 kHz, 500 kHz, and 5 MHz.

The output level is controlled by a continuous attenuator followed by a 4-step attenuator of 20 dB per step and is metered from over 3 volts to below 30 microvolts. When the attenuator is used, the output impedance remains essentially constant as you change the output level.

Frequency response Drive your device under test with the 1390-B and analyze output with any of several GR analyzers, manually or with a graphic level recorder. In contrast with the usual swept-single-frequency methods, this one makes your DUT handle a wide spectrum simultaneously. The distinction may be significant if the DUT is nonlinear.

Use the 1390-B as a broad-band signal source for:

- frequency response
- intermodulation and cross-talk tests
- simulation of telephone-line noise
- measurements on servo amplifiers
- noise interference tests on radar
- determining meter response characteristics
- setting transmission levels in communications circuits
- statistical demonstrations in classroom and lab

Make acoustic measurements:

- frequency response
- reverberation—use 1390-B with a GR analyzer as source of narrow-band noise
- sound attenuation of ducts, walls, panels, or floors
- acoustical properties of materials
- room acoustics

Use it with an amplifier to drive:

- a loudspeaker for structural fatigue tests in high-level acoustic fields
- a vibration shake-table

SPECIFICATIONS

Frequency Range: 5 Hz to 5 MHz.

Output: VOLTAGE: Max open-circuit is at least 3 V for 20-kHz range 2 V for 500-kHz range, and 1 V for 5-MHz range. IMPEDANCE: Source impedance for max output is approx 900 Ω . Output is taken from a 2500- Ω potentiometer. Source impedance for attenuated output is 200 Ω . One output terminal is grounded.



Spectrum: See spectrum-level curves and following table. Note: Spectrum level is shown with constant-Hz-bandwidth analysis, "white" noise being ideally flat. (Pink noise would slope down at 10 dB per decade.)

| Range | Typical Spectrum Level (with 1-V rms output) | Spectrum Level Uniformity* |
|---------|--|--|
| 20 kHz | 5 mV for 1-Hz band | within ± 1 dB, 20 Hz to 20 kHz |
| 500 kHz | 1.2 mV for 1-Hz band | within ± 3 dB, 20 Hz to 500 kHz |
| 5 MHz | 0.6 mV for 1-Hz band | within ± 3 dB, 20 Hz to 500 kHz within ± 8 dB, 500 kHz to 5 MHz |

*Noise energy also beyond these limits. Level is down 3 dB at 5 Hz.



Typical spectrum-level characteristics.

Waveform: Noise source has good normal, or Gaussian, distribution of amplitudes for ranges of the frequency spectrum that are narrow compared with the band selected. Over wide ranges the distribution is less symmetrical because of dissymmetry introduced by the gas tube. Some clipping occurs on the 500-kHz and 5-MHz ranges.

Voltmeter: Rectifier-type averaging meter measures output. It is calibrated to read rms value of noise.

Attenuator: Multiplying factors of 1.0, 0.1, 0.01, 0.001, and 0.0001. Accurate to $\pm 3\%$ to 100 kHz, within $\pm 10\%$ to 5 MHz.

Available: Rack-adaptor set (19x7 in.); 1390-P2 Pink-Noise Filter.

Power: 105 to 125 or 210 to 250 V, 50 to 400 Hz, 50 W.

Mechanical: Convertible bench cabinet. DIMENSIONS (wxhxd): Bench, 12.75x7.5x9.75 in. (324x191x248 mm). WEIGHT: 12 lb (5.5 kg) net, 16 lb (7.5 kg) shipping.

| Description | Catalog Number |
|-------------------------------|----------------|
| 1390-B Random-Noise Generator | 1390-9702 |
| 115-V Model | 1390-9703 |
| 230-V Model | |
| Rack Adaptor Set (7 in.) | 0480-9842 |

1390-P2 Pink-Noise Filter

When white noise is used for frequency-response measurements in conjunction with a constant-percentage bandwidth analyzer (such as the GR 1564-A Sound and Vibration Analyzer or 1568-A Wave Analyzer), the amplitude-frequency characteristic of a flat system appears to slope upward with increasing frequency at a rate of 3 dB per octave, owing to the constantly increasing bandwidth (in hertz) of the analyzer. The 1390-P2 converts the audio-frequency output of the 1390-B from white noise to pink noise, which has constant energy per octave. Thus it flattens the response curves made with a constant-percentage-bandwidth analyzer.

SPECIFICATIONS

Frequency Response: Sloping -3 dB per octave from 20 Hz to 20 kHz, -6 dB per octave above 20 kHz. Output voltage is approx -5 dB with respect to the input voltage at 20 Hz and -35 dB at 20 kHz. It lies within 1 dB of the straight line connecting these two points on a graph of output in decibels vs log frequency.

Over-all Output Level: When the filter is used with the random-noise generator set for the 20-kHz range, the output voltage of the filter is approx 30 dB below its input, and the voltage level in each one-third-octave band is approx 17 dB below that. Thus, when the output meter of the generator indicates 3 V, the output of the filter is approx 0.1 V, and the level in each one-third-octave band is approx 15 mV.

Input Impedance: The filter should be driven from a source whose impedance is 1 k Ω or less. Input impedance is variable from 6.5 k Ω + load resistance at zero frequency to 6.7 k Ω at high frequencies.

Output Impedance: The filter should not be operated into a load of less than 20 k Ω . Internal output impedance is variable from 6.5 k Ω + source resistance at low frequencies to approx 200 Ω at high frequencies.

Max Input Voltage: 15 V rms.

Terminals: Input terminals are recessed banana pins on $\frac{1}{4}$ -in. spacing at rear of unit. Output terminals are jack-top binding posts with $\frac{1}{4}$ -in. spacing.

Mechanical: Plug-in unit housing. DIMENSIONS (wxhxd): 1.38x5x2.87 in. (35x127x73 mm). WEIGHT: 6 oz (0.2 kg) net, 4 lb (1.9 kg) shipping.

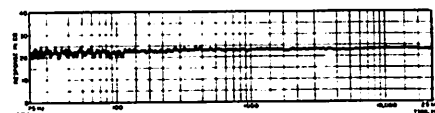
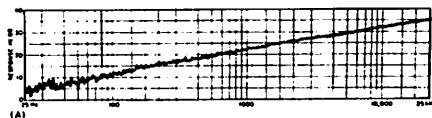

(A) Output (white noise) of the 1390-B Random-Noise Generator and (B) output (pink noise) after filtering by the 1390-P2 Pink-Noise Filter, as measured by a one-third-octave band analyzer.

Description

Catalog
Number

1390-P2 Pink-Noise Filter

1390-9602

1383 Random-Noise Generator

- 20 Hz to 20 MHz, ± 1.5 dB
- 30- μ V to 1-V output, open-circuit
- 50-ohm output impedance
- meter and 10-dB-per-step attenuator

This instrument generates wide-band noise of uniform spectrum level, particularly useful for tests in video- and radio-frequency systems.

The maximum output is one volt open circuit from a 50-ohm source. An 8-step attenuator of 10 dB per step permits reduction of the output level to 30 μ V.



Use the 1383 as a broad-band noise source for

- intermodulation and cross-talk tests
- simulation of noise in carrier systems
- noise-interference tests in radar and telemetry
- determining noise bandwidth
- measuring noise figure
- setting transmission levels in communication circuits
- statistical demonstrations in classroom and lab
- determining meter response characteristics
- measuring noise temperature

SPECIFICATIONS

Spectrum: Flat (constant energy per hertz of bandwidth) ± 1 dB from 20 Hz to 10 MHz, ± 1.5 dB from 10 MHz to 20 MHz.

Waveform: Table shows amplitude-density-distribution specifications of generator compared with the Gaussian probability-density function, as measured in "windows" of 0.2σ , centered on the indicated values of voltage:

| Voltage | Gaussian Prob. Dens. Function | Amplitude-Density Dist. 1383 Random-Noise Gen. |
|---------------|-------------------------------|--|
| 0 | 0.0796 | 0.0796 ± 0.005 |
| $\pm\sigma$ | 0.0484 | 0.0484 ± 0.005 |
| $\pm 2\sigma$ | 0.0109 | 0.0106 ± 0.003 |
| $\pm 3\sigma$ | 0.000998 | 0.000898 ± 0.0003 |

(σ is the standard deviation or rms value of the noise voltage.)

Output: VOLTAGE ≥ 1 V rms open circuit, at full output.
CONTROL: Continuous control and 8-step attenuator of 10 dB/step. **METER:** Indicates open-circuit output voltage ahead of 50 Ω . **IMPEDANCE:** 50 Ω . Can be shorted without causing distortion. **TERMINALS:** GR874[®] coaxial connector that can be mounted on either front or rear panel.

Power: 100 to 125 or 200 to 250 V, 50 to 400 Hz, 40 W.

Mechanical: Convertible bench cabinet. **DIMENSIONS** (wxhxd): Bench, 17x3.87x12.75 in. (432x98x324 mm); rack, 19x3.5x10.75 in. (483x90x273 mm). **WEIGHT:** 14 lb (6.5 kg) net, 21 lb (10 kg) shipping.

* Patent Number 368,168

| Description | Catalog Number |
|-----------------------------|----------------|
| 1383 Random-Noise Generator | 1383-9700 |
| Bench Model | 1383-9701 |
| Rack Model | |

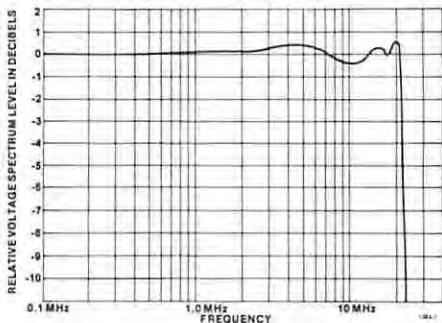

Typical spectrum of 1383 Random-Noise Generator output; energy-per-Hz bandwidth vs frequency.

1952 Universal Filter

- 4-Hz to 60-kHz tuning
- low-pass or high-pass, band-pass or band-reject, ganged for easy tuning
- high attenuation rate—30 dB/octave
- line or battery operation

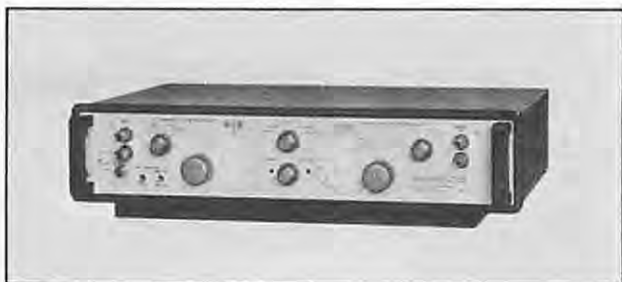

The 1952 Universal Filter will perform as a low-pass, high-pass, band-pass, or band-reject filter at the turn of a panel switch. It consists of low-pass and high-pass filters that can be employed singly, in cascade, or in parallel, to provide the assortment of over-all characteristics. The cut-off frequencies of the two filters can be controlled independently or ganged together to provide constant-percentage bandwidth for band-pass or band-reject tuning.

This filter is of value in many signal-conditioning applications. For example, it can be used to control system bandwidth for reduction of extraneous signals or to evaluate the effect of limited bandwidth upon signal intelligibility and data-transmission accuracy. As a high-pass filter it can reduce power-line-related components, as a low-pass filter control high-frequency noise, or as a notch filter eliminate single-frequency components. The 1952 can also act as part of a spectrum analyzer or distortion meter and, with a random-noise generator, produce controlled bands of noise as test signals.

SPECIFICATIONS

Frequency Range: CUT-OFF FREQUENCIES: Adjustable 4 Hz to 60 kHz in four ranges. PASS-BAND LIMITS: Low-frequency response to dc (approx 0.7 Hz with ac input coupling) in Low Pass and Band Reject modes. High-frequency response uniform ± 0.2 dB to 300 kHz in High Pass and Band Reject modes. CONTROLS: Log frequency-dial calibration; accuracy $\pm 2\%$ of cut-off frequency (at 3-dB points).

Filters: FILTER CHARACTERISTICS: Filters are fourth-order (four-pole) Chebyshev approximations to ideal magnitude response. The nominal pass-band ripple is ± 0.1 dB (± 0.2 dB max); nominal attenuation at the calibrated cut-off frequency is 3 dB; initial attenuation rate is 30 dB per octave. Attenuation at twice or at one-half the selected frequency, as applicable, is at least 30 dB. TUNING MODES: Switch selected, Low Pass, High Pass, Band Pass, and Band Reject. GANGED TUNING: The two frequency controls can be ganged in Band Pass and Band Reject modes so the ratio of upper to lower cut-off frequencies remains constant as controls are adjusted. Range overlap is sufficient to permit tuning through successive ranges without the need to reset frequency controls if ratio of upper to lower cut-off frequencies is 1.5 or less. MINIMUM BANDWIDTH: 26% (approx $\frac{1}{2}$ octave) in Band Pass mode. NULL TUNING: In Band Reject mode, setting the frequency controls for a critical

ratio of upper to lower cut-off frequency (indicated on dials) gives a null characteristic (point of infinite attenuation) that can be tuned from 5 Hz to 50 kHz.

Input: GAIN: 0 or -20 dB, switch selected. **IMPEDANCE:** 100 k Ω . **COUPLING:** Ac or dc, switch selected. Lower cut-off frequency (3 dB down) for ac coupling is about 0.7 Hz. An LC filter at input limits bandwidth to 300 kHz, thus reducing danger of overloading active circuits at frequencies above normal operating range.

Max Input Voltage: SINE WAVE: 3 V rms (8.5 V pk-pk); except with input attenuator at 20 dB, 30 V rms. **DC COUPLED:** ± 4.2 V pk. **AC COUPLED:** Max peak level of ac component must not exceed ± 4.2 V for specified performance; dc level, ± 100 V. Peaks up to ± 100 V are tolerated without damage.

Output: **IMPEDANCE:** 600 Ω . **LOAD:** Any load can be connected without affecting linear operation of output circuit. **TEMPERATURE COEFFICIENT** of output offset voltage: Between 0 and + 4 mV/ $^{\circ}$ C.

Noise: <100 μ V in an effective bandwidth of 50 kHz.

Distortion: Max harmonic distortion, with all components in the pass band, for a linear load, is less than 0.25% for open-circuit voltages up to 3 V and frequencies up to 50 kHz.

Available: Rechargeable batteries (two required) and 1560-P62 Power Supply. Replacement battery: Gould 9.6V/225B with snaps, or equivalent.

Power: 100 to 125 or 200 to 250 V (switch selected), 50 to 60 Hz, 2.5 W. Or 19.2 V, approx 20 mA from rechargeable nickel-cadmium batteries (not supplied), about 10-h operation. Connections for external battery.

Mechanical: Bench or rack models. **DIMENSIONS** (w \times h \times d): Bench, 19 \times 3.87 \times 14.8 in. (483 \times 96 \times 376 mm); rack, 19 \times 3.5 \times 13.63 in. (483 \times 89 \times 346 mm); charger, 4.25 \times 3.75 \times 8 in. (108 \times 95 \times 203 mm). **WEIGHT:** 21 lb (10 kg) net, 25 lb (12 kg) shipping

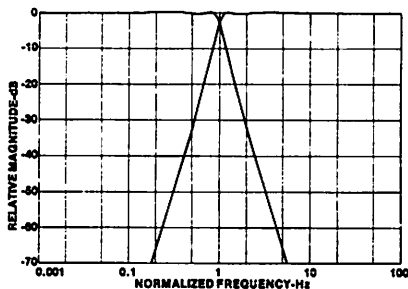

Low-pass and high-pass filter characteristics.

| Description | Catalog Number |
|--------------------------------|----------------|
| 1952 Universal Filter | |
| Bench Model | 1952-9801 |
| Rack Model | 1952-9811 |
| Rechargeable Battery (2 req'd) | 8410-1040 |
| 1560-P62 Power Supply | 1560-9575 |

INDEX

| | | | |
|---|--------------------|--|-----------------------------|
| A standard tone | 3 | Audiogram | 22, 23, 286 |
| A weighted level, conversion to, from octave levels | 120 | Audiometer | 22, 23, 286 |
| A weighted sound levels—limitations | 69 | Audiometer calibrators | 112, 113 |
| to rate noise | 66-69 | Autocorrelation | 124, 125, 286 |
| typical values | 4 | Automatic level regulator | 161 |
| for product noise | 168 | Autospectrum | 134, 140-143, 147, 148, 286 |
| A weighting—frequency response | 8, 189 | Averaging | 139-145 |
| Absorptive treatment | 242-246 | Averaging—exponential and linear | 107, 108 |
| Acceleration—defined | 13, 285 | | |
| Acceleration—level | 13 | B weighted (see A weighted) | |
| Acceleration—measurement (see vibration measurement techniques) | | Background noise—defined | 286 |
| Accelerometer (see vibration pickups) | | Background noise, correction for | 204-206 |
| Acoustic power for rating product noise | 169-171 | Baffle (see also barriers) | 286 |
| Acoustic power, measurement of | 206-214 | Balancing rotating machinery | 254 |
| Acoustical calibration (see calibration and calibrators) | | Ball bearings | 260-262 |
| Acoustical Society of America | 301, 302, 304, 308 | Band numbers | 118, 297 |
| ADC | 306 | Barriers, isolation by | 242-245 |
| Age, hearing variations with | 28, 29 | Beating of tones | 185 |
| AGMA | 306 | Bel—defined | 286 |
| Air Conditioning and Refrigeration Institute | 306 | Bits | 121 |
| Air Diffusion Council | 306 | Blurring effect | 138, 139 |
| Air Moving and Conditioning Association | 306 | | |
| Air-moving systems | 260, 264, 265 | C weighted (see A weighted) | |
| Aircraft noise | 43-54 | C weighting, effect of, on octave-band levels | 190 |
| Airport noise | 177, 178 | Cables, effects of | 96-98, 184 |
| Aliasing | 122-124, 285 | CAGI | 171, 307 |
| Aliasing filters | 123, 124 | Calibration | 185-187 |
| Ambient noise (see background noise) | | Calibration checks | 168-174, 190, 191, 220 |
| AMCA | 306 | Calibrators | 111-113, 168-174, 190, 191 |
| American Gear Manufacturers Association | 306 | Cams | 251, 252, 264 |
| American National Standards Institute | 301-304 | Catalog Section | 310 |
| American Petroleum Institute | 306 | Ceramic microphones (see microphones, ceramic) | |
| American Society for Testing and Materials | 304 | Chatter | 269 |
| American Textile Machinery Association | 306, 307 | Circuit noise, effects of | 183 |
| Amplitude density distribution | 129-131, 285 | CNEL | 57, 177, 178 |
| Amplitude distribution | 128-132, 285 | CNR | 58, 59 |
| Analog vs digital | 121, 148 | Coherence | 148, 286 |
| Analysis | Chapter 8 | Community noise | |
| Analysis, 1/2-octave band, for product noise | 169-171, 173 | analyzer | 109, 110, 176 |
| Analysis, octave band, for product noise | 169-171, 173 | characteristics | 224-227 |
| Analyzer—defined | 285 | equivalent sound level (see CNEL) | |
| 1/2-octave-band | 152-154 | measurements | Chapter 14, 176-178 |
| FFT | 154, 155 | response to | 69, 70 |
| octave-band | 151, 152 | Comparison method of measuring power | 213, 214 |
| real-time | 153-155 | Components | 120 |
| two-channel | 155 | Composite noise rating (CNR) | 58, 59 |
| Anechoic room | 199, 286 | Compressed Air and Gas Institute | 171, 307 |
| Annoyance | 30 | Condenser microphones (see microphones) | |
| ANSI | 301-304 | Confidence limits | 140, 286 |
| Anti-aliasing filters (see aliasing filters) | | Confidence limits for octave bands | 144, 145 |
| Anti-Friction Bearing Manufacturers Association | 307 | Control of noise (see noise reduction) | |
| Area monitoring | 21 | Control of vibration (see vibration reduction) | |
| ARI | 170, 171, 306 | Convolution | 126, 127 |
| Articulation index | 61 | Correction for frequency response | 187-190 |
| ASHRAE | 170, 171, 304, 305 | Correlation | 124-126, 147 |
| Association of Home Appliance Manufacturers | 307 | Crest factor—defined | 286 |
| ASTM | 170, 304 | Critical bandwidth | 64 |
| Atmospheric pressure, effects of | 190-192 | Critical ratio | 64, 65 |
| | | Critical speed | 254, 287 |

| | |
|---|--------------------------------|
| Cross-correlation | 124-126, 147, 287 |
| Cross-spectrum | 134, 147, 148, 287 |
| Cycles per second (now "hertz") | 3 |
| D weighted levels | 66, 67 |
| Damping, vibration | 255, 256 |
| Data window (see also window) | 287 |
| Day-night sound level | 57, 69, 70, 176, 223, 224, 228 |
| Dead room (see also anechoic room) | 287 |
| Decay rate | 170, 294 |
| Decibel (dB) | |
| conversion tables | 275-280 |
| defined | 3-5, 287 |
| how to combine | 9, 10, 281 |
| Definitions | 285-299 |
| Degrees of freedom | 139-141, 287 |
| Detection theory | 26 |
| Detectors—squaring, rms, peak | 106, 107 |
| Diesel Engine Manufacturers Association | 307 |
| Differential sensitivity | 65 |
| Diffuse field (see also reverberation room) | 287 |
| Digital filtering | 133 |
| Directional gain | 288 |
| Directional response of microphone | 86-88 |
| Directional source | 196-199, 200-203 |
| Directivity factor | 199-203, 211, 287 |
| Discomfort threshold | 28 |
| Displacement—measurement (see vibration measurement techniques) | |
| Displacement—defined | 12, 288 |
| Distribution (see amplitude distribution) | |
| DNL (see day-night sound level) | |
| Dosimeter (see noise dosimeter) | |
| Double amplitude | 12 |
| Duration—effect on annoyance | 43, 50, 51 |
| Dynamic range | 122, 146, 147 |
| Dynamic range of community noise | 220 |
| E weighted levels | 66-68 |
| Ear | 17, 18 |
| Ear protection | 22 |
| Earphone | 288 |
| Earphones, use of | 192 |
| Effective bandwidth | 138-141, 145, 146 |
| Effective perceived noise level (EPNL) | 51 |
| Effective sound pressure | 288 |
| Electret microphones (see microphones) | |
| Electric machinery, noise from | 171 |
| Electric motors | 265-268 |
| Enclosures | 242-246 |
| Ensemble average—defined | 288 |
| Environmental noise | 176-178 |
| EQL | 56, 57 |
| Equal loudness contours | 8, 31, 32 |
| Equivalent continuous sound level | 20, 21 |
| Equivalent sound level | 56, 57, 69, 70, 288 |
| Exceedance levels | 57, 58, 221-223, 227-229 |
| Excess level | 139 |
| Exchange rate | 18, 19, 21 |
| Fans | 260, 264 |
| Far field | 197, 198 |
| Fast averaging | 108, 184, 185 |
| Fast Fourier transform (see FFT) | |
| Federal aviation regulations, part 36 | 43-54 |
| FFT | 133-136, 137, 139-143, 289 |
| FFT analyzers | 154, 155 |
| Field | |
| far | 197, 198 |
| geometric | 198 |
| inertial | 198 |
| near | 197, 198 |
| defined | 289 |
| continuously adjustable | 156 |
| digital | 133 |
| Filtering, direct | 132-133 |
| Flat response | 7, 8 |
| Flexural vibration | 11 |
| Fluctuating sounds | 145, 146 |
| Folding | 124, 289 |
| Fourier transform (see FFT) | |
| Frame | 124, 134-136, 289 |
| Frame period | 134 |
| Frame size | 124, 289 |
| Free field | 195-199, 289 |

| | |
|--|-----------------------------------|
| Frequency | 289 |
| Frequency distribution | 129-131, 289 |
| Frequency response—microphones | 84-88, 93 |
| Frequency response—sound level meters | 8, 188, 189 |
| Frequency shifting | 132, 137 |
| Frequency translation, digital | 137 |
| Frequency, analysis in bands of (see analysis) | |
| g-defined | 103, 289 |
| Gas flow | 260, 265 |
| Gaussian | 129-131, 289 |
| Gear-drive vibration | 253, 263, 264 |
| Geometric field | 198 |
| Graphic recorders | 157, 158 |
| Grazing incidence response | 88 |
| Hanning | 136, 141, 289 |
| Harmonic analysis (see analysis) | |
| Harmonic index | 9 |
| Harmonic motion | 12 |
| Hearing—masking | 60-64, 291 |
| conservation | Chapter 3 |
| damage risk | 176, Chapter 3 |
| loss—defined | 18, 290 |
| loss—possible causes | 29, 30, Chapter 3 |
| monitoring | 22, 23 |
| protection | 22, Chapter 3 |
| threshold level | 27, 28, 31, 32, 290 |
| frequency range of | 27, 28, 31, 32 |
| Hemispherical measurements | 209, 210 |
| Hertz (formerly cycles per second)—defined | 3 |
| Heterodyning | 132, 137 |
| High frequency noise | 91, 92 |
| High sound levels | 90, 91 |
| High sound levels—precautions in measurement | 184 |
| Histogram | 129, 130, 290 |
| Home Ventilating Institute | 307 |
| HUD exposure limits | 58 |
| Hum pickup | 96, 183, 184 |
| Humidity, effects of | 92, 93 |
| Hydraulic pumps | 260, 264 |
| Hydrophones | 99 |
| IEC | 302, 303 |
| IEEE | 305 |
| Impact—defined | 290 |
| Impulse noise | 108 |
| Impulse-type sound-level meter | 108 |
| Incidence, grazing | 85, 88 |
| Incidence, perpendicular | 85, 86, 88, 182, 218 |
| Incidence, random | 85, 87, 182, 218 |
| Indoor noise levels | 63, 64 |
| Industrial Silencer Manufacturers Association | 307 |
| Inertial field | 198 |
| Institute of Electrical and Electronic Engineers | 305 |
| Instrument case, effect of, on measurement | 181, 182 |
| Instrumentation | Chapter 6, 7, 9, 10 |
| Integrating sound-level meters | 109, 110 |
| Internal combustion engines | 269 |
| International Conference of Building Officials | 307 |
| International Electrotechnical Commission | 302, 303 |
| International Organization for Standardization | 303, 304 |
| ISO | 303, 304 |
| Isolation—defined | 290 |
| Isolation (see vibration isolators) | |
| Jerk | 13, 290 |
| Journals, list of | 308 |
| Kilohertz | 3 |
| L1, L10, L50, L90, L99 (see exceedance levels) | |
| Lag | 125 |
| L _{dn} (see day-night sound level) | |
| Leakage | 135, 136 |
| Leg | 56, 57, 69, 70, 176, 221-229, 288 |
| Level (see loudness, power, sound, etc, level) | |
| defined | 290 |
| distribution | 131, 132, 290 |
| regulator | 161 |
| Line component (see also components) | 291 |
| Live room—defined | 291 |
| Loudness—defined | 291 |
| Loudness—sones | 33, 291, 296 |

| | |
|---|----------------------------|
| Loudness and loudness level | 30-37, 291 |
| calculations | 34-37 |
| Stevens | 34-37 |
| table for converting | 282 |
| Zwicker | 37 |
| Loudness index | 34-37 |
| Loudspeaker | 291 |
| Low frequency noise | 92 |
| Low noise levels | 183 |
| Machinery maintenance (see preventive maintenance) | 78-81 |
| Machinery preventive maintenance (see preventive maintenance) | |
| Magnetic tape recorder | 139 |
| Magnetostriction | 260, 265, 268, 269 |
| Maintenance (see preventive maintenance) | |
| Mark VI | 34-37 |
| Mark VII | 37-42 |
| Masking | 60-64, 291 |
| Measurement points | 207-210, 213 |
| Measurement techniques | Chapter 12-14 |
| Measurements, record of | 193 |
| Mechanical impedance | 291 |
| Mechanical shock | 291 |
| Mels | 66, 291 |
| Meter pointer behavior | 143-146, 184, 185 |
| Meter reading | 221 |
| Microphone | |
| microbar | 292 |
| atmospheric pressure effects | 99 |
| defined | 292 |
| directional response | 86-88 |
| distortion | 91 |
| long term stability | 94-96 |
| temperature effects | 93, 94 |
| use with long cables | 96, 98 |
| vibration sensitivity | 98 |
| wind screen | 97, 98 |
| mounting | 102 |
| orientation | 85-88, 182, 218 |
| position—community noise | 218, 219 |
| position (see also measurement points) | 21, 22, 182 |
| sensitivity | 88, 89 |
| ceramic | 85 |
| choice and use of | 89-99 |
| condenser | 85, 86 |
| effects of humidity on | 92, 93 |
| electret-condenser | 83-85 |
| piezoelectric | 85 |
| Microphones | Chapter 6 |
| Microphonics, effects of | 184 |
| Minimum audible field (MAF) | 27, 28 |
| Motor-vehicle noise | 177 |
| Mounting device under test | 204, 213, 214, 237 |
| Mounting vibration pickups | 231-237 |
| N weighted levels | 66 |
| National Electrical Manufacturers Association | 307 |
| National Fluid Power Association | 307 |
| National Machine Tool Builders Association | 307 |
| NC curves | 55 |
| NCA curves | 55 |
| Near field | 197, 198 |
| NEF | 58, 59 |
| NEMA | 307 |
| Newtons per square meter | 3, 292 |
| Noise | |
| NNI | 58, 59, 292 |
| defined | 292 |
| effect on sleep | 71 |
| effect on work output | 70, 71 |
| effects on hearing | Chapter 3 |
| non-auditory effects | 71 |
| analysis (see analysis) | |
| and number index (NNI) | 59 |
| background | 194, 204-206 |
| control | Chapter 16, 17 |
| control—case histories | 273 |
| criteria for residential areas | 69, 70, 176-178 |
| criteria for speech interference | 60-64 |
| criteria for telephone use | 62, 63 |
| criterion curves | 55 |
| dosimeter | 19, 21, 22, 60 |
| exposure forecast (NEF) | 58 |
| exposure permissible | 18-21 |
| Interference with speech | 61-64 |
| level—defined | 292 |
| levels, combining (chart for) | 281 |
| levels, criteria for, in offices | 63, 64 |
| levels, criteria for, indoors | 63, 64 |
| measurements | Chapter 12-14 |
| ordinances | 176, 177 |
| pollution level (NPL) | 59 |
| rating | 66-69 |
| reduction | 173, 174, Chapter 16, 17 |
| reduction at source | 239-241, 246-259 |
| test codes, measurements for | 168-174 |
| how to measure | Chapter 12-14 |
| pink | 138, 293 |
| random (see random noise) | |
| single number ratings for | 66-69 |
| stationary (see stationary) | |
| white | 299 |
| Normal distribution | 129-131 |
| Noys | 43-54, 292 |
| NPL | 59 |
| NP curves | 56 |
| Nyquist frequency | 121 |
| Nyquist interval | 121, 131, 292 |
| Observer, effect of, on measurements | 181, 182 |
| Observer position | 219, 220 |
| Occupational Safety and Health Act (OSHA) | Chapter 3 |
| Octave-defined | 293 |
| Octave-band | |
| analysis | 117-120, 169-171, 144, 173 |
| analysis for product noise | 169-171, 173 |
| analyzers | 151-152 |
| confidence limits | 144, 145 |
| level—conversion to spectrum level | 119 |
| levels—related to a-weighted level | 120 |
| Oil whirl | 260, 263 |
| Omnidirectional response | 6 |
| One-third octave—defined | 293 |
| One-third octave (see third octave) | |
| Oscillation—defined | 293 |
| Oscilloscope | 162 |
| OSHA (Occupational Safety and Health Act) | 19, 20 |
| Outdoor microphone system | 102 |
| Parallel filtering | 132-133 |
| Pascal | 3, 293 |
| Path, changes in, to reduce noise | 241-246 |
| Peak detector | 106, 108 |
| Peak-to-peak value—defined | 293 |
| Perceived level | 37-42 |
| Perceived-noise level | 43-54, 293 |
| Periodic signals | 142, 143, 293, 294 |
| Permanent threshold shift (PTS) | 18 |
| Perpendicular incidence response | 88 |
| Personal monitoring | 19, 21 |
| Personal noise dosimeter | 19, 21, 22 |
| Phon (see also loudness level) | 32, 293 |
| Pickups (see vibration pickups) | |
| Pink noise | 138, 293 |
| Pitch | 66, 293 |
| PNdB (see perceived noise level) | |
| Point source (see simple sound source) | 195, 196 |
| Position of microphone (see also measurement points) | 21, 22 |
| Power emission level | 7 |
| Power level | |
| corrections for temp and pressure | 196, 212 |
| defined | 5, 294 |
| typical values | 6 |
| calculation | 195, 196, 210-214 |
| in free field | 195-199 |
| measurement | Chapter 13 |
| Power reference | 5, 6, 14 |
| Power Saw Manufacturers Association | 308 |
| Power spectrum | 134 |
| Preamplifiers | 99-102 |
| Preamplifiers, distortion in | 101 |
| Precision sound-level meter | 105, 106, 187-190 |
| Predicting levels in room | 214, 215 |
| Predictive maintenance (see preventive maintenance) | |
| Preferred frequencies | 117, 118 |
| Presbycusis (see also hearing) | 28, 29, 294 |
| Pressure | |
| reference | 7, 14 |
| response | 88 |
| spectrum level—defined | 294 |

| | |
|--|--------------------------------|
| Preventive maintenance | 174-176, 257-259 |
| Privacy | 64 |
| Product noise | 168-174 |
| Product noise reduction (see noise reduction) | |
| Production line testing for noise | 172, 173 |
| PSIL | 61-64, 294 |
| Psychoacoustics | 25 |
| Psychophysical methods | 25, 26 |
| Pure tone—defined | 296 |
| Q-directivity factor | 199-203, 211, 287 |
| Quantization | 121, 122, 146, 147, 294 |
| Quieter processes and operations | 240 |
| R-C average | 107 |
| Raised cosine window (see window, hanning) | |
| Random incidence response | 87, 88 |
| Random motions | 11 |
| Random noise | 32, 138-146, 185, 294 |
| Random noise, average level of | 185 |
| Random-noise generators | 159, 160 |
| Rate of decay (see also decay rate) | 294 |
| Real time | 146 |
| Real-time analyzer, third-octave | 153, 154 |
| Record of measurements | 193, 194, 223, 224 |
| Recorder, magnetic-tape | 159 |
| Recorders, graphic | 157, 158 |
| Recorders, X-Y | 158 |
| Rectangular window (see window) | |
| Reference quantities | 3, 5, 7, 13-15 |
| Reflections, sound | 199-204, 211-215 |
| Regulator, automatic level | 161 |
| Resolution | 134 |
| Resonance | 295 |
| Resonant vibration | 254-256 |
| Response—defined | 295 |
| Reverberant field | 202-204 |
| Reverberation room, measurements in | 182, 183, 199-204 |
| Reverberation—defined | 295 |
| Reverberation room | 200-215 |
| Reverberation time measurement | 170, 295 |
| Rms (root mean square) | 106, 107, 125, 130, 131, 295 |
| Roller bearings | 260-262 |
| Room constant | 200-204 |
| Room effect on measurements | 183, 199-204, 211-214 |
| Room requirements | 212-214 |
| Root mean square (see rms) | |
| Rotating electric machinery, noise from (see electric machinery) | |
| Rotor vibration (see also unbalance) | 260, 261, 269 |
| ROC (receiver operating characteristic) | 26 |
| SAE | 305, 306 |
| Sample deviation | 57 |
| Sampling | 121-124, 129-131, 143-145, 295 |
| Sampling sound level-meters | 109, 110 |
| Sampling techniques for community noise | 221-223, 229 |
| SEL | 60 |
| Sensitivity, transducer | 88, 89, 103 |
| Serial filtering | 132-133, 137 |
| Shaft vibration | 260, 261, 269 |
| Shakers, vibration | 162, 163 |
| Shock mounts (see vibration isolators) | |
| SI weighted levels | 66-68 |
| Sigma (see standard deviation) | |
| SIL | 61-64 |
| Simple sound source | 195, 196 |
| Simple sound source—defined | 295 |
| Simple tone—defined | 295 |
| Simulated free field | 199 |
| Sleep, effects of noise on | 71 |
| Slow averaging | 108, 184, 185 |
| Society of Automotive Engineers | 305, 306 |
| Sone (see loudness) | |
| Sound | |
| sonic—defined | 296 |
| attenuation in air | 201 |
| defined | 3, 296 |
| speed | 3, 14 |
| summary of terms | 14 |
| absorption (see also absorptive treatment) | 201, 296 |
| exposure level (SEL) | 60, 296 |
| fields—free field | 195-199 |
| fields—near field and far field | 197, 198 |
| fields in rooms | 199-204 |
| fields, point source in | 195, 196 |

| | |
|--|---|
| intensity—defined | 296 |
| level—defined | 7, 8, 297 |
| level, how to measure | Chapter 12-14 |
| level, A weighted (see also A-weighted) | 8 |
| levels, typical A-weighted | 4 |
| Sound-level | |
| calibrators | 111, 112, 168-174, 190, 191, 220 |
| meter—response and tolerances | 8, 187-190 |
| meter—types | 105, 106, 187-190 |
| meter held in hand | 181 |
| meter, temperature effects on | 110, 111 |
| meters | Chapter 7 |
| meters differences among | 187-190 |
| Sound power, comparison method for | 213, 214 |
| Sound power, measurement of | 206-214 |
| Sound pressure level | |
| defined | 7, 297 |
| overall, flat | 7 |
| reference (levels) | 7, 14 |
| for directional source | 199-203 |
| Sound propagation | 217, 218 |
| Spectrum | |
| defined | 297 |
| analysis (see analysis) | |
| analyzers (see analyzers) | |
| averaging | 139-141 |
| density | 119 |
| level | 119, 297 |
| Speech interference level (SIL) (PSIL) | 60-64, 294 |
| Speed of sound | 3, 14 |
| SPL (see sound-pressure level) | |
| Standard deviation | 57, 130, 131, 297 |
| Standards, sound and vibration | 301-308 |
| Standing wave—defined | 297 |
| Stationary | 130, 131, 142, 298 |
| Statistical stability | 134, 139-146 |
| Stethoscope, use of | 192 |
| Stroboscopes | 163-166 |
| Subjective comparisons of noise | 25 |
| Summation analysis | 127, 128 |
| Superposition | 126, 127 |
| TA | 58 |
| Tape recorder | 159 |
| Telephone usability | 62, 63 |
| Temperature effects on batteries | 111 |
| Temperature effects on microphones | 93, 94 |
| Temporary threshold shift (TTS) | 18, 23 |
| Test codes, measurements for noise | 168-174 |
| Third-octave analysis | 117-119, 133, 138, 139, 148, 152-154, 169-175 |
| Third-octave corrections for spectrum level | 119 |
| Third-octave-band analyzers | 152-154 |
| Threshold of hearing | 27, 28, 298 |
| Threshold of pain | 27, 28 |
| TIF—defined | 298 |
| Time average (see also average) | 298 |
| Time compression | 136, 137 |
| Time domain | 124-128 |
| Time series | 121, 298 |
| Tone—defined | 298 |
| Tone corrections | 43, 45, 47-50 |
| Tone-burst generator | 160-161 |
| Torsional vibration | 11, 257 |
| Transducer—defined | 298 |
| Transducer sensitivity | 88, 89, 103 |
| Transfer function | 147, 148, 298 |
| Transformer noise | 268, 269 |
| Transient vibration—defined | 299 |
| Truncation | 134-136 |
| TTS | 18, 23 |
| Two-channel analyzers | 155 |
| Ultrasonics—defined | 299 |
| Unbalance, vibration from | 254, 258, 260, 261 |
| USA standards (see American National Standards Institute) | |
| Variance | 57, 130, 299 |
| Velocity—defined | 12, 13, 299 |
| Velocity—level | 13 |
| Vibration (see also: acceleration, displacement, velocity) | |
| Vibration | |
| calibration of measurement systems | 113, 237, 238 |
| classes of | 10, 11 |
| criteria | 76, 77 |

| | |
|---|-----------------------------|
| defined | 10, 299 |
| effects on man | 75-78 |
| miscellaneous effects | 81 |
| threshold of perception | 76 |
| calibrator | 113 |
| control systems | 162, 163 |
| conversion charts | 283, 284 |
| isolators | 242-251, 256, 257, 299 |
| measurement techniques | Chapter 15 |
| meter—defined | 299 |
| pickup for sound-level meter | 113 |
| pickups | 103 |
| pickups—method of use | 231-237 |
| reduction | 173, 174, Chapter 16, 17 |
| shakers | 162, 163 |
| acceptable limits of | 77, 78 |
| non-sinusoidal | 13 |
| problems related to | 75, 78-81, 174-176, 257-259 |
| sinusoidal | 12, 13 |
| Vibratory force, sources of | 251-254, 257-269 |
| Wave analysis (see analysis) | |
| Waveform—defined | 299 |
| Waveform averaging | 127, 128, 141, 299 |
| Wavelength | 197, 198 |
| Weighting characteristics | 4, 8, 66-69, 187-190, 299 |
| Whip, friction | 260, 261 |
| White noise—defined | 299 |
| Wind effects | 97, 98, 218, 219 |
| Wind noise | 97, 98, 219 |
| Wind screen | 97, 98 |
| Window | 134-136 |
| Window, hanning | 136, 141 |
| Woodworking Machinery Manufacturers Association | 308 |
| Words used to describe sounds | 300 |
| Work output, effects of noise on | 70, 71 |
| X-Y recorders158 | |
| Zoom137 | |