

R6-111.111K
R6-1,111.110K
Decade Resistor
User and Service Manual



Copyright © 2015 IET Labs, Inc.
Visit www.ietlabs.com for manual revision updates

R6 im/Oct. 2015

Effectivity: Models with serial no. beginning with R4 or greater

◆ PRECISION INSTRUMENTS FOR TEST AND MEASUREMENT ◆



IET LABS, INC.

www.ietlabs.com
Email: info@ietlabs.com
TEL: (516) 334-5959 • FAX: (516) 334-5988

WARRANTY

We warrant that this product is free from defects in material and workmanship and, when properly used, will perform in accordance with applicable IET specifications. If within one year after original shipment, it is found not to meet this standard, it will be repaired or, at the option of IET, replaced at no charge when returned to IET. Changes in this product not approved by IET or application of voltages or currents greater than those allowed by the specifications shall void this warranty. IET shall not be liable for any indirect, special, or consequential damages, even if notice has been given to the possibility of such damages.

THIS WARRANTY IS IN LIEU OF ALL OTHER WARRANTIES, EXPRESSED OR IMPLIED, INCLUDING BUT NOT LIMITED TO, ANY IMPLIED WARRANTY OF MERCHANTABILITY OR FITNESS FOR ANY PARTICULAR PURPOSE.



WARNING



OBSERVE ALL SAFETY RULES
WHEN WORKING WITH HIGH VOLTAGES OR LINE VOLTAGES.

**Dangerous voltages may be present inside this instrument. Do not open the case
Refer servicing to qualified personnel**

HIGH VOLTAGES MAY BE PRESENT AT THE TERMINALS OF THIS INSTRUMENT

WHENEVER HAZARDOUS VOLTAGES (> 45 V) ARE USED, TAKE ALL MEASURES TO
AVOID ACCIDENTAL CONTACT WITH ANY LIVE COMPONENTS.

USE MAXIMUM INSULATION AND MINIMIZE THE USE OF BARE
CONDUCTORS WHEN USING THIS INSTRUMENT.

Use extreme caution when working with bare conductors or bus bars.

WHEN WORKING WITH HIGH VOLTAGES, POST WARNING SIGNS AND
KEEP UNREQUIRED PERSONNEL SAFELY AWAY.



CAUTION



DO NOT APPLY ANY VOLTAGES OR CURRENTS TO THE TERMINALS OF THIS
INSTRUMENT IN EXCESS OF THE MAXIMUM LIMITS INDICATED ON
THE FRONT PANEL OR THE OPERATING GUIDE LABEL.

Contents

Chapter 1: Introduction	
1.1 Introduction.....	1
Chapter 2: Specifications	
Specifications	2
Chapter 3: Operation	
3.1 Initial Inspection and Setup	4
3.2 Connection	4
3.2.1 General Considerations.....	4
3.2.2 Electrical Considerations.....	5
3.2.3 Four-Wire Kelvin Lead Connections.....	5
3.2.4 ac Considerations.....	5
3.2.5 Thermal emf Considerations.....	5
3.3 Dial Setting	6
3.4 Environmental Conditions	6
Chapter 4: Maintenance	
4.1 Verification of Performance	7
4.1.1 Calibration Interval.....	7
4.1.2 General Considerations.....	7
4.1.3 Calibration Procedure	7
4.2 Schematic	8
4.3 Replaceable Parts List.....	9

Figures and Tables

<i>Figure 1-1</i>	<i>R6-111.111K Decade Resistor</i>	<i>1</i>
<i>Figure 2-1</i>	<i>Operating Guide Affixed to Unit</i>	<i>3</i>
<i>Figure 3-1</i>	<i>Connections to Decade Resistor for $\leq 1M\Omega$, at DC</i>	<i>4</i>
<i>Figure 3-2</i>	<i>Connections to Decade Resistor for $\geq 1M\Omega$, at DC</i>	<i>4</i>
<i>Figure 3-3</i>	<i>Optimal 4-Wire Kelvin Lead Connection</i>	<i>5</i>
<i>Figure 3-4</i>	<i>Decade Resistor AC Model</i>	<i>5</i>
<i>Figure 4-1</i>	<i>HARS Series Schematic Diagram</i>	<i>8</i>
<i>Table 4-2</i>	<i>Replacement List</i>	<i>9</i>
<i>Figure 4-2</i>	<i>HARS-X Replaceable Parts</i>	<i>9</i>

Chapter 1

INTRODUCTION

1.1 Introduction

The **R6-111.111K** and **R6-1,111.110K Decade Resistors** are high-performance decade resistance boxes. The **R6** feature 6 decades with the **R6-111.111K** having a resolution of 0.1Ω and the **R6-1,111.110K** a resolution of 1Ω . The **R6** decade resistors are a precision resistance sources with excellent characteristics of stability, temperature coefficient, power coefficient, and frequency response. See Figure 1-1.

The **R6** employs very low resistance switches with silver-alloy contacts. A special design keeps zero resistance to less than $2 \text{ m}\Omega$ per decade. Self cleaning keeps the silver contacts from becoming tarnished when unused, or when only low currents are passed through them. This is most often the case when only minute test currents are drawn by digital multimeters or other test instruments. Contact resistance is stable and remains low and repeatable.

High-quality, heavy-duty, gold-plated tellurium-copper binding posts serve to minimize the thermal emf effects which would artificially reflect a change in dc resistance measurements. All other conductors within the instrument, as well as the solder employed, contain no metals or junctions that could contribute to thermal emf problems.

The panel is clearly labeled showing the step size and maximum voltage and current limitations for each decade.

With a resolution as low as 0.1Ω and a maximum available resistance of over $1 \text{ M}\Omega$, the **R6** may be used for exacting precision measurement applications requiring high accuracy, good stability, and low zero-resistance. They can be used as components of dc and ac bridges, for calibration, as transfer standards, and as RTD simulators.

The unit may be rack-mounted to serve as a component in measurement and control systems.



Figure 1-1. R6-1,111.110K Decade Resistor

Chapter 2

SPECIFICATIONS

For convenience to the user, the pertinent specifications are given in an **OPERATING GUIDE** affixed to the case of the instrument. Figure 2.1 shows a typical example.

SPECIFICATIONS

		Resistance per step	Total decade resistance	Max current	Max voltage (per step)	Max power (per step)	Stability (\pm ppm/yr)	Long-term stability (\pm ppm/3 yrs)	Temperature coefficient (\pm ppm/ $^{\circ}$ C)	Resistor type
R6-111.111 k Ω	R6-1,111.110 k Ω	100 m Ω	1 Ω	1.6 A	0.16 V	0.25 W	50	75	20	Resistance wire
		1 Ω	10 Ω	0.8 A	0.8 V	0.6 W	20	25	20	Wirewound, non-inductive
		10 Ω	100 Ω	0.25 A	2.5 V	0.6 W	20	25	15	
		100 Ω	1 k Ω	80 mA	8 V	0.6 W	20	25	5	
		1 k Ω	10 k Ω	23 mA	23 V	0.5 W	20	25	5	
		10 k Ω	100 k Ω	7 mA	70 V	0.5 W	20	25	5	
		100 k Ω	1 M Ω	2.3 mA*	230 V*	0.5 W*	20	25	5	

*Subject to maximum of 2000 V to case.

Accuracy:

$\pm(0.01\% + 2 \text{ m}\Omega)$
After subtraction of zero-resistance, at 23 $^{\circ}$ C;
traceable to SI

Zero resistance:

$\leq 2 \text{ m}\Omega$ per decade

Switch type:

Multiple solid silver alloy contacts, continuous rotation

Switch capacitance:

<1 pF between contacts

Operation:

If switches have not been operated for an extended period of time, they should be rotated a few times in both directions to restore contact resistance to specifications.

Terminals:

Low-thermal-emf tellurium-copper binding posts with standard 3/4 inch spacing, plus shield terminal. A shorting link may be used to connect the low terminal to the case.

Environmental conditions:

Operating conditions: +10 to +40 $^{\circ}$ C, <80% RH

Storage conditions: -40 to +70 $^{\circ}$ C

Dimensions:

43.8 cm W x 8.9 cm H x 8.9 cm D

17.3 in W x 3.5 in H x 3.5 in D

Weight:

1.4 kg (3.1 lb)

R6-1,111.110K DECADE RESISTANCE BOX

CONSULT INSTRUCTION MANUAL FOR PROPER INSTRUMENT OPERATION

Resistance per step	Total decade resistance	Max current	Max voltage per step	Power per step (W)	Stability (±ppm/yr)	Long-term stability (±ppm/3 yrs)	Temp. coefficient (±ppm/°C)	Resistor type
1 Ω	10 Ω	.8 A	0.8 V	0.6	20	25	20	Wiredwound, non-inductive
10 Ω	100 Ω	.25 A	2.5 V	0.6	20	25	15	
100 Ω	1 kΩ	80 mA	8 V	0.6	20	25	5	
1 kΩ	10 kΩ	23 mA	23 V	0.5	20	25	5	
10 kΩ	100 kΩ	7 mA	70 V	0.5	20	25	5	
100 kΩ	1 MΩ	2.3 mA*	230 V*	0.5*	20	25	5	

*Subject to maximum of 2000 V to case

Accuracy:
±(0.01% + 2 mΩ)
After subtraction of zero resistance, at 23°C; traceable to SI

Zero Resistance:
≤2 mΩ per decade

Switch Capacitance:
<1 pF between contacts

WARNING
Observe all safety rules when working with high voltages or line voltages. Connect the (G) terminal to earth ground in order to maintain the case at a safe voltage. Whenever hazardous voltages (>45 V) are used, take all measures to avoid accidental contact with any live components: a) Use maximum insulation and minimize the use of bare conductors. b) Remove power when adjusting switches. c) Post warning signs and keep personnel safely away.

Operating Conditions:
+10 to +40 °C, <80% RH

Storage Conditions:
-40 to +70 °C

Operation:
If switches have not been operated for an extended period, they should be rotated a few times to restore contact resistance to specifications.

MODEL: R6-1,111.110k **SN:** R4-XXXXXXXXXX



IET LABS, INC.
CAGE CODE: 62015



• Long Island, NY • Email: info@ietlabs.com • Tel: (516) 334-5959
• www.ietlabs.com

RX:label02-03-04-2014.65%

Figure 2-1 Typical Operating Guide Affixed to Unit

Chapter 3

OPERATION

3.1 Initial Inspection and Setup

This instrument was carefully inspected before shipment. It should be in proper electrical and mechanical order upon receipt.

An **OPERATING GUIDE** is attached to the case of the instrument to provide ready reference to specifications.

3.2 Connection

3.2.1 General Considerations

The **R6** unit provides three terminals labeled **H** (high), **L** (low), and **G** (ground). The **H** and **L** terminals are connected to the ends of the resistance being set; the **G** terminal is connected to the case. See Figure 4-1.

2-Terminal, 3-Terminal, and shorting link considerations

Clearly, the **R6**, as shown in Figure 4-1, is a 3-terminal device, connecting the **G** and the **L** binding posts together will make this a 2-terminal device. How to connect the **R6** will depend on the user's measurement instrument or application and the frequency of use. This section will be about dc use only.

For most applications, for the low resistances found in the **R6**, even up to $1\text{ M}\Omega$, 2 and 3-terminal measurement will be equally effective.

For best performance, for all but high resistance ($<1\text{ M}\Omega$), the connection for best stability and minimum noise is as shown in Figure 3-1.

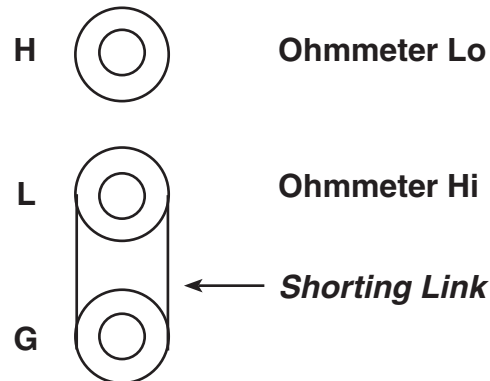

Figure 3-1 Connections to Decade Resistor for $\leq 1\text{ M}\Omega$, at dc

For higher resistance ($\geq 1\text{ M}\Omega$), where noise may become a consideration, the connection in Figure 3-2 should be employed.

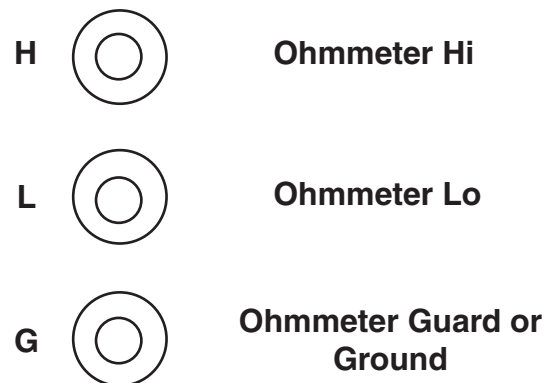

Figure 3-2 Connections to Decade Resistor for $\geq 1\text{ M}\Omega$, at ac or dc

3.2.2 Electrical Considerations

In order to make proper use of the full performance capabilities of the **R6** unit, especially if low resistance or low-resistance increments are important, take care when connecting to the terminals of the decade box. In particular, in order to keep contact resistance to a minimum, take the most substantial and secure connection to the binding posts. They accept banana plugs, telephone tips, spade lugs, alligator clips, and bare wire. The largest or heaviest mating connection should be made, and, where applicable, the binding posts should be securely tightened.

These considerations may be relaxed whenever single milliohms are considered insignificant for the task being performed.

3.2.3 Four-Wire Kelvin Lead Connections

Whenever possible, 4-wire Kelvin leads, the ideal connection, should be employed. Such a connection minimizes the effects of contact resistance and approaches ideal performance.

If the four terminals are available as clamps similar to alligator clips, they may be connected to the necks of the binding posts. If the four terminals are available separately, the optimal connection is shown in Figure 3.1, where the current leads are introduced into the top of the binding posts, and the voltage leads at the necks

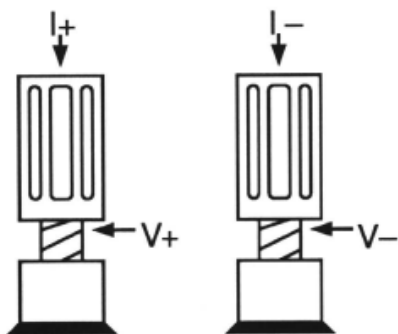

Figure 3-3 Optimal 4-Wire Kelvin Lead Connection

3.2.4 ac Considerations

For ac applications the **R6** resistance may be assumed to behave at dc for up to about 20 kHz for resistance values less than 100 k Ω .

A general model of a decade resistor is given in Figure 3-4.

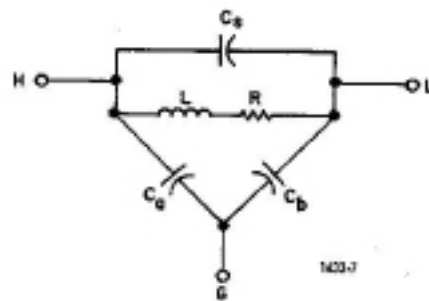

Figure 3-4 Decade Resistor ac Model

For resistances ≤ 1 k Ω , a Series Model measurement should be used, for values ≥ 10 k Ω , a parallel resistance model should be used. Either model may be used in between.

Using the Decade Resistor as a 3-terminal device has the effect of reducing the shunt capacitance across the resistance resulting in improved frequency response when measuring R_s for resistance values above 1 k Ω .

3.2.5 Thermal emf Considerations

The highest-quality low-emf components are used in the **R6** unit. There nevertheless may be some minute thermal emf generated at the test leads where they contact the gold-plated binding posts.

This emf will not reflect itself if an ac measurement instrument is employed. It will also be eliminated if a meter with a "True Ohm" capability is used. Otherwise it may represent itself as a false component of the dc resistance measurement. It is also possible to take a second measurement with the leads reversed and average the reading.

3.3 Dial Setting

Whenever the dials are used in positions 0-9, the resulting resistance is read directly. Both the decimal point and the steps are clearly marked on the panel.

For additional flexibility and range, each decade provides a “10” position setting. This “10” position on any one decade equals the “1” position on the next higher decade. It adds about 11% to the nominal total decade resistance.

To determine the resistance obtained when one or more “10” settings are used, simply add “1” to the next higher decade. For example, a setting of 3-6-10-0-10 Ω becomes:

3	3	0	0	0	0
6	6	0	0	0	0
10	1	0	0	0	
0			0	0	
__10			1	0	
TOT	3	7	0	1	0

and a setting of 10-10-10-10-10.10 Ω becomes:

10	1	0	0	0	0	0.0
10	1	0	0	0	0	0.0
10	1	0	0	0	0	0.0
10	1	0	0	0	0	0.0
10			1	0	0	0.0
.10					1	0.0
TOT	1	1	1	1	1	1.0

3.4 Environmental Conditions

For optimal accuracy, the decade box should be used in an environment of 23°C. It should be allowed to stabilize at that temperature after any significant temperature variation.

Humidity should be maintained at laboratory conditions. This is especially important if high resistances are involved.

Chapter 4

MAINTENANCE

4.1 Verification of Performance

4.1.1 Calibration Interval

The **R6** instruments should be verified for performance at a calibration interval of twelve (12) months. This procedure may be carried out by the user if a calibration capability is available, by IET Labs, or by a certified calibration laboratory.

If the user should choose to perform this procedure, then the considerations below should be observed.

4.1.2 General Considerations

It is important, whenever testing the **R6** units, to be very aware of the capabilities and limitations of the test instruments used. A resistance bridge may be employed, and there are direct-reading resistance meters or digital multimeters available that can verify the accuracy of these units, especially when used in conjunction with standards that can serve to confirm or improve the accuracy of the testing instrument

Such test instruments must be significantly more accurate than $\pm(100 \text{ ppm} + 2 \text{ m}\Omega)$ for all applicable ranges, allowing for a band of uncertainty of the instrument itself. A number of commercial bridges and meters exist that can perform this task; consult IET Labs.

It is important to allow both the testing instrument and the **R6** unit to stabilize for a number of hours at the nominal operating temperature of 23°C, and at nominal laboratory conditions of humidity.

There should be no temperature gradients across the unit under test.

Substantial Kelvin-type 4-wire test terminals should be used to obtain accurate low-resistance readings. It is convenient, once the zero resistance has been determined, to subtract it from the remaining measurements. This can be automatically done in many instruments which have an offset subtraction capability.

4.1.3 Calibration Procedure

1. Confirm the zero resistance of the unit.
2. Determine the allowable upper and lower limits for each resistance setting of each decade based on the specified accuracy.
For the R6, these limits for any resistance "R" are $[R \pm (0.0001 R + 2 \text{ m}\Omega)]$.
3. Confirm that the resistances fall within these limits after subtraction of the zero resistance.
4. If any resistances fall outside these limits, the associated switch assembly may require service or replacement.

4.2 Schematic

Refer to Figure 4-1 for a schematic of the R6 unit.

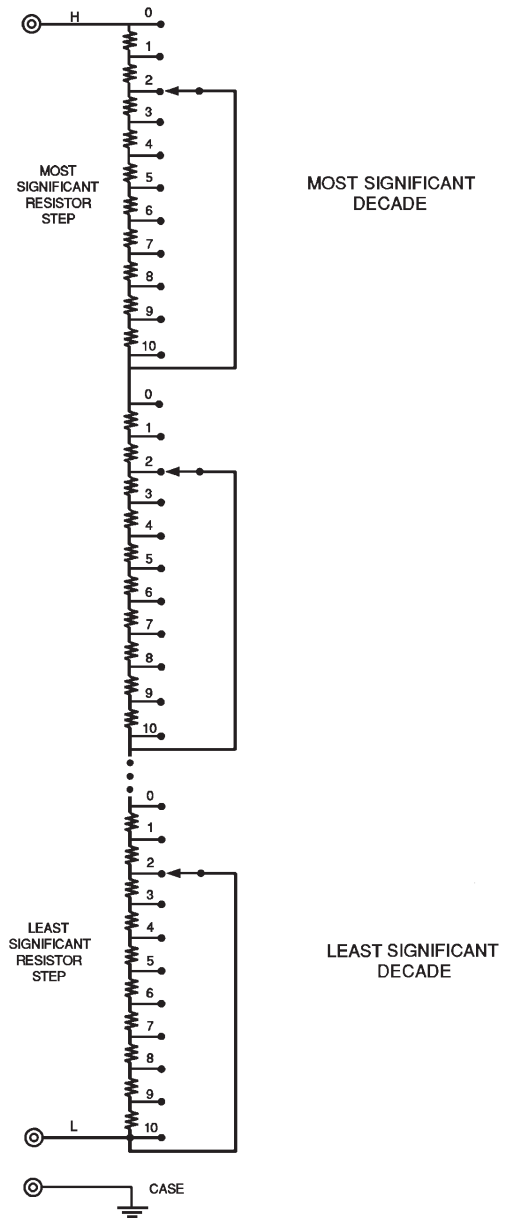

Figure 4-1. R6 Unit Schematic Diagram

4.3 Replaceable Parts List

Model Ref	IET Pt No	Description
1	BP-1000-RD	Binding Post, Red
2	BP-1000-BK	Binding Post, Black
3	BP-1000-GN	Binding Post, Green
4	HARS-X-4300-KNB	Knob Assembly
Not Shown	HARS-X-3100	Foot
Not Shown	HARS-4100-X-0.1	0.1 Ω /step Decade Switch Assembly (R6-111.111 k Ω only)
Not Shown	HARS-4100-X-1	1 Ω /step Decade Switch Assembly
Not Shown	HARS-4100-X-10	10 Ω /step Decade Switch Assembly
Not Shown	HARS-4100-X-100	100 Ω /step Decade Switch Assembly
Not Shown	HARS-4100-X-1k	1 k Ω /step Decade Switch Assembly
Not Shown	HARS-4100-X-10k	10 k Ω /step Decade Switch Assembly
Not Shown	HARS-4100-X-100k	100 k Ω /step Decade Switch Assembly (R6-1,111.110 k Ω only)

Table 4.2: Replacement List

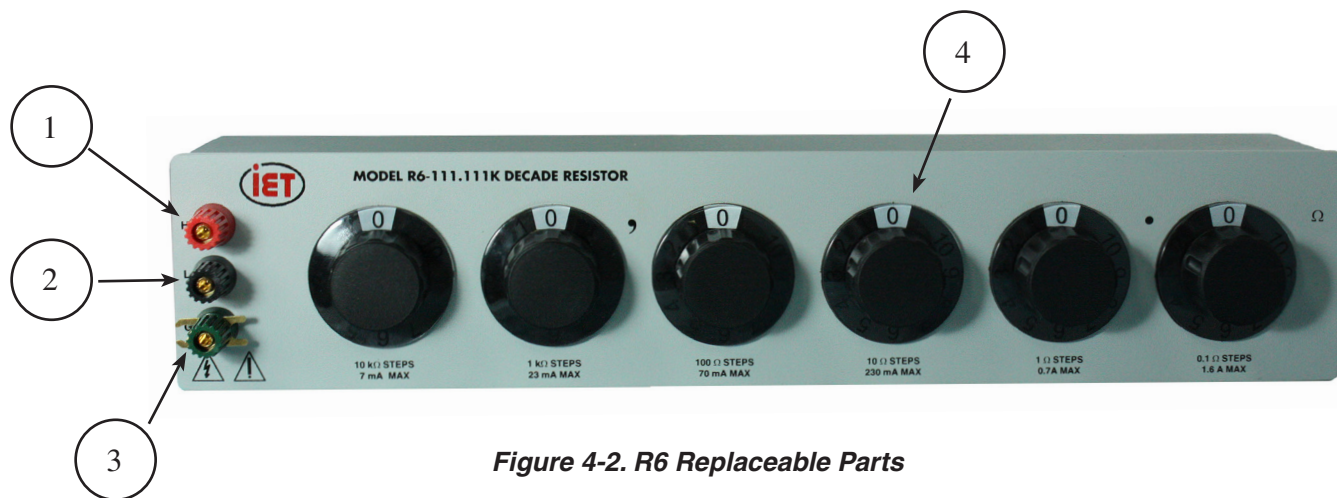

Figure 4-2. R6 Replaceable Parts