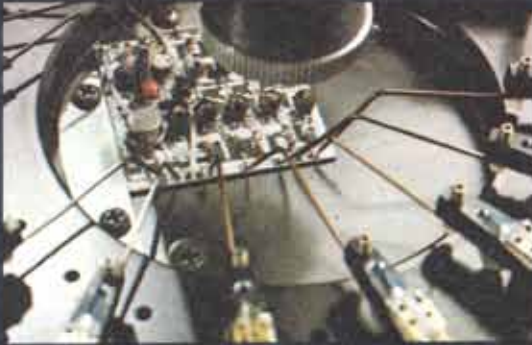

Table of Contents

Sales and Service Facilities	12
Sound and Vibration	21
Industrial Hearing Conservation	24
Product-Noise Reduction	39
Signal Analysis and Graphic Recording	49
Oscillators and Noise Generators	74
General Instrumentation and Accessories	86
Component and Network Testing	
Automatic and Computer-Controlled Systems	105
Automatic Bridges	138
Manual Impedance Bridges	150
Capacitance Bridges and Standards	155
Resistance Bridges and Standards	180
Inductance Bridges and Standards	192
High Frequency	
Systems	201
Sources	219
GR874® and GR900® Coaxial Devices	237
General	
Strobotac® Stroboscopes	269
Variac® Line-Voltage Control	285
Sources, Attenuators, and Counters	313
Miscellany	331
Domestic Price List .. (at the back of the catalog)	





22108
AC 22108

- 22108 PRINT T 800' 4
- 22108 BROADCAST ENGINE 1
- 22108 TYPE 100-114
- 22108 TYPE 100-11 AC 200' 4
- 22108 TYPE 100-114
- 22108 TYPE 100-11 AC 200' 4
- 22108 TYPE 100-114
- 22108 TYPE 100-11 AC 200' 4
- 22108 TYPE 100-114
- 22108 ENG 1





A Catalog of Change

General Radio's first general catalog appeared in 1916, one year after the company was founded. Successive editions followed a somewhat standard format but contained more pages, described more products, and were designed to reflect then current tastes in aesthetic considerations.

Many changes have occurred since we published our last catalog, Catalog U, both in measurement technology and within General Radio itself. Consequently, you will find in Catalog 73 several pages that describe new capabilities, new product lines, new subsidiaries and company associations, and new sales and service facilities, reflecting a greater responsiveness to customer needs.

Of course, the common denominator is markets; the nature of the products has changed, however, as has the relative importance of traditional products to both our customers and to General Radio. Most noteworthy of mention is the activity that has been going on within GR during the past few years in the area of systems design. As the world, in general, and the electronics industry, in particular, continue to accelerate in the direction of more and more automation, the needs grow for sophisticated instrumentation that will test more parameters on more units in less time, and with minimum human involvement. The solution frequently calls for a computer-controlled system, and GR has rapidly developed an expertise in applying computer technology to automatic measuring systems.

We sincerely hope this catalog presents you with a clear, concise picture of the current scene at General Radio. We welcome any comments or suggestions you might have regarding our products, service, policies, or any other matters.

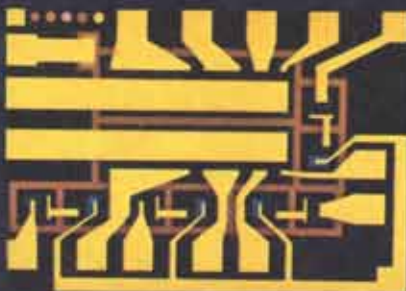

 **General Radio Company**
CONCORD, MASSACHUSETTS, USA

General Radio Canada Limited
TORONTO, ONTARIO, CANADA
470 miles

General Radio Company (Overseas)
ZURICH, SWITZERLAND
4,775 miles

General Radio France
PARIS, FRANCE
4,562 miles

General Radio GmbH
MÜNCHEN, WEST GERMANY
5,125 miles

General Radio Italia SpA.
MILANO, ITALY
5,000 miles

General Radio Company (UK) Limited
BOURNE END, BUCKINGHAMSHIRE, ENGLAND
4,437 miles

Grason-Stadler Company Inc.
A GR COMPANY
CONCORD, MASSACHUSETTS, USA
1/2 mile

Techware Computing Corporation
A GR COMPANY
ST. PETERSBURG, FLORIDA, USA
1,470 miles

Time/Data Corporation
A GR COMPANY
PALO ALTO, CALIFORNIA, USA
3,375 miles

Micronetic Systems Inc.
A GR ASSOCIATE
BURLINGTON, MASSACHUSETTS, USA
8 miles

Computerwrap™ Corporation
A GR ASSOCIATE
BURLINGTON, MASSACHUSETTS, USA
8 miles

GR/TODAY: a multi-company, international organization

In 1970, General Radio expanded its technical capabilities by joining forces with Time/Data and Grason-Stadler, both of whom specialize in product lines that complement those of General Radio. Time/Data, although a relatively new comer to the business world at the time of the merger, has quickly and effectively established itself as a leader in the field of real-time analysis. Grason-Stadler, which was founded in 1949, is recognized worldwide as a designer and manufacturer of high-quality instruments for audiology, psychoacoustics, behavioral science, and related fields. Both affiliates operate independently, although operations, methods, and functional organizations have been interfaced wherever practical to reduce manufacturing costs and to provide maximum service to customers.

More recently, General Radio became associated with three other companies. Techware Computing Corporation, a wholly owned subsidiary, markets a computer-aided system for use with N/C machinery, resulting in substantial savings of time, material, and labor. Micronetic Systems, with a firm foothold in the newly emerged technology of laser

trimming of resistors, sells and services its laser-trim systems through most of GR's worldwide marketing organization. A similar association exists with Micronetic Systems' newly acquired subsidiary, ComputerWrap™ Corporation, a manufacturer of semi-automatic wire-wrap machines that bear the trade name ComputerWrap.

Paramount to the corporate- and product-oriented changes are the moves that have been made to strengthen the arm of General Radio which is closest to the customer, namely sales and services. While continuing to locate sales engineers as close as possible to customers, we have centralized our sales and services facilities in the U.S.A. in four Regional Centers for more efficient and prompt assistance to customers. Field product specialists provide expert problem-solving assistance in all major product areas and where it is most useful — in proximity to the customer. Seminars, customer training, and product demonstrations are now available at company headquarters, at the Regional Centers, and at our sales/service facilities in Canada and Europe.



GR/TODAY: applying experience and expertise to the development of new technologies and techniques for measurement and analysis

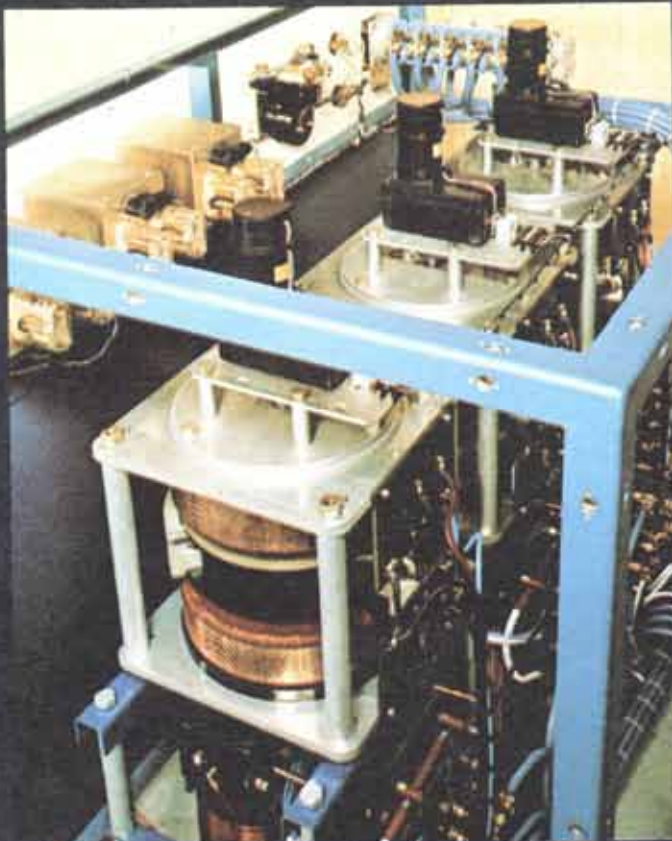



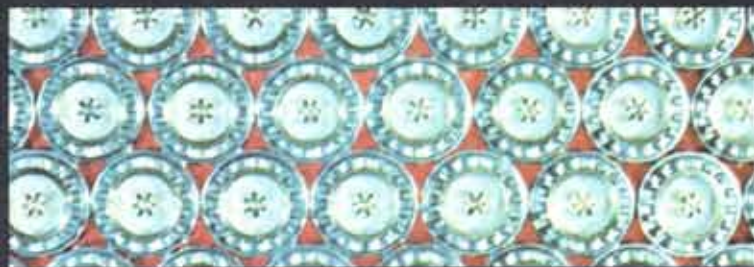



GR/TODAY: serving its customers through a
WORLD-WIDE SALES AND SERVICE NETWORK

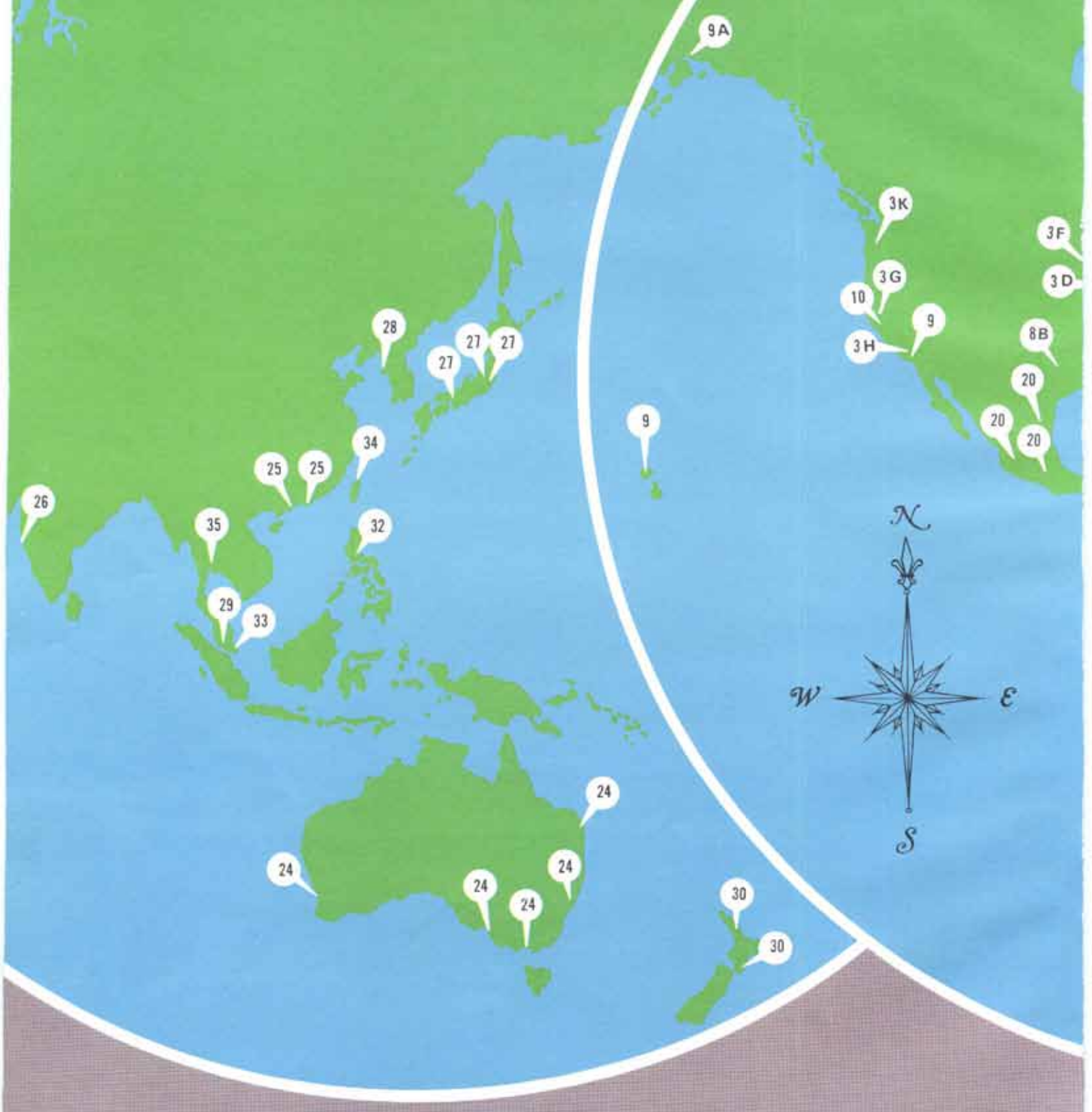

Sales and Service

The sales/service facilities identified on the preceding pages have been geographically located so as to shorten as much as possible the communication link between GR and its customers. You, the customer, need only to contact the facility nearest you, as indicated by the color-coded dots, for prompt sales and service assistance. Each facility, whether GR owned and operated or that of a carefully selected representative, is staffed by sales and service personnel who have received thorough factory training on the products described in this catalog.

Warranty

Each product manufactured by General Radio and its associated companies, described in this catalog, is warranted against defects in material and workmanship. The following excerpt, from a typical product warranty, is intended to illustrate the basic provisions of our product warranty policy:

"... [this product], properly used, will perform in full accordance with applicable specifications. If, within a period of ten years after original shipment, it is found, after examination by us or our authorized representative, not to meet this standard, it will be repaired or, at our option, replaced as follows:

- No charge for parts, labor or transportation during the first three months after original shipment;
- No charge for parts or labor during the fourth through the twelfth month after original shipment for a product returned to a GR service facility;
- No charge for parts during the second year after original shipment for a product returned to a GR service facility;

- During the third through the tenth year after original shipment, and as long thereafter as parts are available, we will maintain our repair capability and it will be available at our then prevailing schedule of charges for a product returned to a GR service facility."

The complete warranty applying to each product appears in the instruction manual provided with the product.

Service Policy

Your local GR office or representative will assist you in all matters relating to product maintenance, such as calibration, repair, replacement parts and service contracts. Field servicing of GR system products can be accomplished by any of the following methods:

- By GR on a contract specifying a fixed price per period or per call,
- By GR on a per call basis with no contract, or
- By the customer, after service training by GR.

Products that have been repaired at a GR service facility, with a charge for both parts and labor, are warranted to perform in full accordance with the specifications in effect at the time of original shipment. If, within a period of six months after such repair, it is found and verified by us that the product fails to meet this standard, it will be repaired or, at our option, replaced with no charge for parts or labor, provided the product is returned to a GR service facility.

Any GR product returned for credit will be subject to a restocking charge. If more than six months have elapsed since original shipment, it will not be accepted for credit. Authorization must be obtained from your local GR office or representative before a product is returned for credit.

Ordering Information

The procedures, terms, and conditions outlined on these pages are those of the General Radio Company. Generally, they also apply to the subsidiary and associate companies of General Radio and, where practical, exceptions are noted herein. However, all exceptions are not covered and we advise that you contact your nearest sales office to verify specific terms and conditions.

Where to Order

USA and Canada

Please address orders and other communications to the sales facility nearest you, as indicated by the color code on pages 12 through 16.

Other Countries

Customers outside the United States and Canada are served by General Radio, its European subsidiaries, and by various export representations, all located on the map (pages 10 and 11) and listed on pages 12 through 16. Please direct all communications to the appropriate representative. For countries not listed, inquiries should be addressed to General Radio Company, Concord, Massachusetts 01742, USA or, for customers in Western and Eastern Europe, the Middle East, and Africa, to General Radio Company (Overseas), P.O. Box, CH-8034 Zürich, Switzerland.

How to Order

Standard Catalog Terms

Always order by catalog number (if included), type number, and complete description. Some ac-operated instruments are supplied wired for operation from 115-volt power, unless otherwise specified, although most instruments come equipped with a 115-V/230-V slide switch that permits selectable power operation. Most instruments can also be supplied for operation from other common voltages and frequencies as indicated in the specifications under Power. Be sure to specify operating voltage and frequency if other than nominal 115 volts, 60 Hz.

For example:

Catalog No. 1900-9801, Type 1900-A Wave Analyzer, 230 V, 50 Hz, Bench Model.

Special Features

Special features and modifications not listed in the specifications (such as extra calibrations or software) are available at extra cost. Please include in your order information regarding any nonstandard features desired.

Nonstandard Systems

Systems that require hardware and/or software other than that described in the catalog are subject to quotation. Please make reference to the quotation when placing your order for the applicable system.

Conditions of Sale

Determination of prices, terms and conditions of sale and final acceptance of orders are made only at the manufacturer's headquarters; at General Radio Canada Limited, Toronto, Canada; or at any of the European subsidiaries of the General Radio Company.

USA and Canada

Terms are net 30 days if credit has been arranged; otherwise, unless payment is received before shipment, shipment will be made COD.

Outside USA and Canada

Terms of payment for orders placed on General Radio representatives and on General Radio European subsidiaries are those that are mutually agreed upon. If there is no representative in your area, the terms for orders placed directly on General Radio Company or on General Radio Company (Overseas) are full payment in advance of shipment or an irrevocable letter of credit, unless other terms have been previously arranged.

Quantity Discount

The following quantity discounts apply for identical units and packages purchased on a single order, normally for single shipment to one destination. All items are subject to these discounts.

Quantity	1-9	10-19	20-49	50-99	100
Discount	List	10%	13%	17%	20%

Applies only to General Radio Company and Grason-Stadler products.

Minimum Billing

The minimum billing per order is \$10.00. This applies to all purchases except repair parts and cash-with-order transactions. Exception: \$25.00 minimum billing for ComputerWrap Corp.

Source-Inspection Surcharge

A surcharge of 1 percent (\$2.50 minimum) applies on all orders requiring inspection before shipment. The inspection surcharge applies on each shipment inspected and covers only our costs. Exception: Not applicable to ComputerWrap Corp.

Shipping Instructions

Unless specific instructions accompany the order, we shall use our judgment as to the best method of shipment. Shipments can be made by either air or surface transportation. For fast delivery, at a reasonable premium over other means, air shipment is generally recommended and will be employed on request.

Prices

The prices in the price list attached to the domestic copies of this catalog apply only on transactions originating in the USA, include the cost of domestic packing, are FOB factory, Concord, Massachusetts, and are exclusive of all taxes now in effect or that may be imposed by Federal, State or local governments. Exceptions are noted in the price list.

Prices given in the price list are subject to change without notice. Formal price quotations remain in effect for 30 days, 60 days for Time/Data quotations and quotations to export customers. An export-order-handling charge and special packing charge are applied to export orders. Applicable FOB prices for transactions originating outside the USA may be obtained from the General Radio subsidiary or representative nearest you (see pages 10 through 16).

Power-Supply Considerations

General Radio ac-operated instruments will meet the published specifications when operated from power lines whose voltages and frequencies are within the limits stated in the specifications under the heading Power.

Most instruments have input voltage ranges of 100 to 125 and 200 to 250 volts and will therefore operate on nominal power-line voltages of 115, 220, 230, and 240 volts. The voltage range for which an instrument is wired is marked at the power-input plug or cord. Proper fuses for this voltage range are fitted in the fuse holders.

When the power-line voltage on which the instrument is to be operated is specified on the order, the necessary changes in connections, fuses, and name plate are made at the factory. Instruments equipped with line-voltage-selector slide switches are set for 115 volts when shipped.

Certain instruments are available for use only on power lines of 220, 230, and 240 volts (nominal).

For most instruments, the normal operating frequency range is 50 to 60 hertz.

All ac-operated instruments are supplied with three-wire power cords, designed for USA standard three-wire receptacles.

Battery Operation

Portable, battery-operated instruments are shipped with dry-cell batteries packed separately to prevent drain and leakage during shipment. To render the instrument operative, the user need only install the batteries.

Dimensions

Over-all dimensions are given for instruments except that the depth dimension for rack-mount instruments is actually depth behind panel, i.e., clearance required. However, no allowance is made for additional clearance that may be required for cables and connectors at rear panel.

Publications

General Radio publishes several handbooks, primers, and periodicals that provide readers with a wealth of technical information on a variety of subjects. Hundreds of thousands of copies of this literature have been distributed, and much of it is used throughout the world in classrooms and for in-plant training programs. Copies may be obtained through any of our sales offices or by writing to the Sales Promotion Department, General Radio Company, Concord, MA 01742.

Handbook of Noise Measurement Recently published in its seventh edition, this hard-cover classic containing 328 fact-filled pages is generally regarded as must reading for anyone engaged in acoustical measurements. Single-copy price in the USA is \$7.50, with quantity discounts starting at 10 copies.

Handbook of Stroboscopy The fascinating subject of stroboscopy is thoroughly covered in easy-to-understand terms in this 125-page, dramatically illustrated handbook. Single-copy USA price: \$2.00.

Handbook of High-Speed Photography The fine points of how to photograph high-speed events inexpensively, with a stroboscope as the light source, are described in this 96-page popular handbook. USA price: \$1.00.

Handbook of Coaxial Microwave Measurements This 169-page handbook was written for people who have a

need to know the basics of microwave measurements. USA price: \$2.00.

GR/TODAY A new periodical that is mailed to our entire mailing list to keep our customers informed of the many activities taking place within GR and its subsidiary companies. No charge.

Noise Measurement A popular and informative periodical mailed free of charge to those on our mailing list who have indicated an interest in acoustic measurements.

Strobotactics Exciting and unusual applications of stroboscopy are reported in the pages of this publication. No charge.

Primers Three primers that are in great demand and have had several reprintings each are: **A Primer of Noise Measurement**, **Primer of Plant-Noise Measurement and Hearing Testing**, and **A Primer of Stroboscopy**. Each is sent free of charge upon request.

Also available are a number of Instrument Notes, reprints of technical articles, catalog pamphlets on specific product lines, product data sheets, etc. Product information in several languages other than English is available from General Radio Company (Overseas), P.O. Box, CH-8034 Zürich, Switzerland.



Typical Acoustic Systems

In recent years, the normal requirements in acoustics and vibration measurement have become so complex that in many applications an assemblage of general-purpose instruments is no longer adequate. To meet the more demanding situations, General Radio offers complete systems — groups of instruments fully integrated to provide a total solution to a specific measurement need.

Standard software supplied is, of course, dependent upon the system and its components. This software nor-

mally includes programs for all standard analysis operations, system diagnostics and maintenance as well as manuals for operating, programming and maintenance. Custom-tailored software is always available at your option.

The systems illustrated are but a small sample of the versatility of General Radio's "complete solution" approach to create systems or modify standard products to meet your special requirements.

Time/Data 1923 Fast Fourier Transform Analyzer

This system is used primarily for high-speed time-series analysis and synthesis under the control of a computer. This permits analysis of electrical signals in real time with a speed and economy not possible with a computer alone. Such systems now are in use in oceanography, biomedical and geophysical research, radar signal processing, speech analysis, environmental science studies, analysis of medical data, and for structural-dynamics investigations that may include the analysis of vibratory characteristics of all types of products. The Fourier transform and all other algorithms plus system control and operations are performed by the computer with complete software supplied with the system.

Automatic Real-Time Analysis System

This Real-Time Analysis System, designed for a major U.S. shipbuilding company, is a computer-controlled system for the analysis of many kinds of signals with $\frac{1}{2}$ -octave-band filters from 3.15 Hz to 80 kHz. A single input signal can be applied through a front-panel DIRECT INPUT connection or up to ten (10) signals can be applied through a multi-channel scanner with connections at the rear. The analysis is presented at the output on a dc recorder, an oscilloscope, a line printer, a punched paper tape, and a teletypewriter. All commands are sent to the system by the operator at the teletypewriter and conversation with the system is provided by the teletypewriter.



Sound and Vibration

Noise — its impact on our society is increasing rapidly. Contributing factors are increased population density, greater mechanization, and increased public awareness and concern about physiological and psychological effects of noise. With the requirements of new noise standards and legislation coupled with advanced instrumentation, the measurement and control of industrial, community, and product noise have become far more important in recent years.

Vibration control is gaining a similar increase in attention, particularly in the product category. The engineer realizes that in many instances control of vibration is necessary before any effective control of noise can be accomplished.

A leader in acoustic measurements since it introduced the first commercial sound-level meter in 1933, GR has seen major emphasis placed on its acoustic and signal analysis product lines with the passage, in the United States, of The Occupational Safety and Health Act. Now, with Grason-Stadler, GR can supply all the equipment you need to comply with the noise-measurement standards prescribed by various regulatory agencies. In

our broad acoustics line are sound-level meters and calibrators, vibration meters, impact-noise analyzers, pre-amplifiers, audiometers, audiometer calibrators, real-time analyzers, recorders, wave analyzers, sound and vibration analyzers, octave-band analyzers, audiometric rooms and many related products.

This section contains:

- Acoustic Systems
- Industrial Hearing Conservation
 - Plant-Noise Measurement
 - Hearing Testing
 - Calibration
- Product-Noise Reduction
 - Measurement
 - Analysis and Recording
- Test-System Building Blocks
 - Low-Frequency Oscillators
 - Random-Noise Generators
 - Low-Frequency Instrumentation
- Accessories



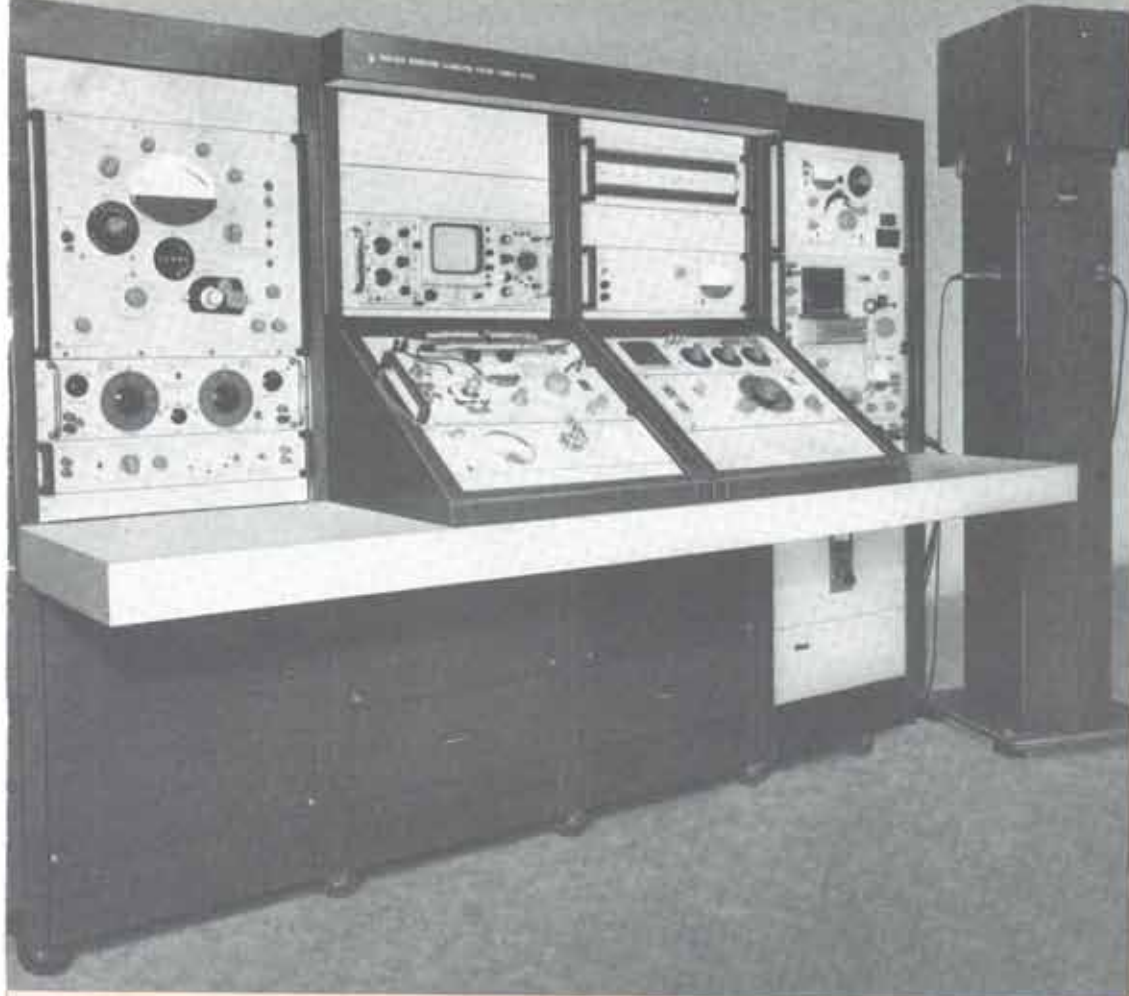

Sound Calibration Console

This Sound Calibration Console was supplied to the Calibration and Meteorology Division, Newark Air Force Station, Newark, Ohio, for use as a laboratory standard of acoustical calibrations for the U.S. Air Force. Among the measurement capabilities of the console are the following:

Microphone Calibration
Frequency Analysis

Narrow Band
1/3-Octave Band
Octave Band

Characteristics of Anechoic Rooms and Chambers
Reverberation Measurements
Frequency Response
Measurement and Analysis of Tape-Recorded Signals



Automatic Real-Time Analysis Systems

These systems were designed for a U.S. Navy facility for the automatic analysis of sound and vibration signals. They consist of discrete, compact instruments that can be readily interconnected to provide one-third octave-band analysis in real time. Signals from up to 16 transducers—hydrophones, microphones or accelerometers—can be measured and analyzed. A visual display and automatic plot are provided, and the system may be easily interfaced to a digital printer or digital computer. Typical applications include the measurement of platform noise, structure-borne noise, and sonar self-noise. The system may also be used for signature-analysis studies and in preventive-maintenance programs. Several systems are shown during final check-out before shipment.

Industrial Hearing Conservation

Hearing-conservation programs in industry are becoming mandatory, especially in view of recent U.S. federal legislation.

The concern over excessive noise in industrial environments has increased significantly in the last few years. Part of this concern stems from the latter-day recognition that pollution of any type is damaging to individual welfare. More important is the mounting evidence that excessive noise causes not only hearing damage, accelerated deafness, and decreased worker efficiency but other severe physiological and psychological damage as well.

Of particular concern to industry are the rise in hearing-damage lawsuits (averaging \$1500 to \$2000 per settlement in some areas) and the recent federal law defining permissible noise levels.

The problem consists of three distinct parts — first to locate noise hazards and to determine their magnitude, second to determine whether employee hearing is affected and to what extent, and third to initiate noise-reduction measures.

All three parts of the problem must be taken into account for any successful hearing-conservation program. Such a program invariably begins with investigation to

determine the extent of the problem and ends after investigation to determine the effectiveness of the solution. Since each phase involves particular instrumentation and measurement techniques, wise selection of equipment is particularly important.

If not properly thought out, equipment selection can result in a very expensive program. You may have duplication, deficiencies necessitating several instruments for one job, poor reliability, or instruments that are excessively difficult or time consuming to operate or that require highly-trained operators. Apparently "economical" equipment can be completely ineffective simply because it won't do the job.

One solution to the problem is the package approach evolved by General Radio to provide fully integrated instrumentation for an effective and economical program.

This approach combines the expertise of General Radio in noise measurements, the experience of Grason-Stadler in audiometric techniques, and the leadership of the Industrial Acoustics Company in audiometric examination rooms. The result is a complete array of hearing-conservation equipment — all from one source and with a singular system responsibility.



Plant-Noise Measurement

The Walsh-Healey impetus There is still no general agreement as to exactly how much noise, what type of noise, or what durations of exposure to noise constitute a health hazard. But a legal definition of excessive noise has been established and probably will be the accepted guide for some time to come.

The definition comes in the form of safety regulations issued by the U.S. Department of Labor under the Walsh-Healey Public Contracts Act. Early in 1969, Section 50-204.10 was added to this act. With this section, the act provided, for the first time, noise limits beyond which manufacturers were compelled to take steps to protect their employees' hearing. Although the Walsh-Healey Act applied only to manufacturers selling to the federal government goods valued in excess of \$10,000 or services valued in excess of \$2500, more recent legislation has extended the coverage to all industries involved in interstate commerce.

This later measure, the Occupational Safety and Health Act (Public Law 91-596 — OSHA), also encourages industrial plants to purchase equipment for noise measurement and monitoring and for workers' protection through periodic audiometer tests of their hearing. OSHA also authorizes the establishment of a large organization to administer and enforce the standards.

Noise Exposure Limits

Band	Noise Level, dB(A)	Limit, hours
—	under 90	unlimited
A	90 to 92	6
B	92 to 95	4
C	95 to 97	3
D	97 to 100	2
E	100 to 102	1.5
F	102 to 105	1
G	105 to 110	0.5
H	110 to 115	0.25
—	above 115	none

The Walsh-Healey exposure limits, as incorporated in OSHA, are given in the accompanying table. The exposures given are those permissible for a normal 8-hour working day. When the noise consists of differing levels throughout the day, their combined effect is considered

as follows. The total cumulative noise exposure, expressed as a percentage of the allowable limit, is C_T :

$$C_T = 100 \left[\frac{C_A}{6} + \frac{C_B}{4} + \frac{C_C}{3} + \frac{C_D}{2} + \frac{C_E}{1.5} + C_F + 2C_G + 4C_H \right]$$

where C_A is the total time the noise level is in band A, C_B is the total time the noise level is in band B, etc.

These limits are based on tests which show that, to avoid increasing the risk of noise-induced hearing loss, the duration of exposure must be reduced 50% for each 5 dB(A) increase in level. The noise levels are specified as dB(A) because A-weighted levels have been found to correlate well with hearing loss.

One way to make noise measurements to the OSHA criteria is by means of a 1563 or 1565-B Sound-Level Meter. The 1563 meets the requirements of ANSI S1.4-1971 Type 3 and the 1565-B meets the more stringent requirements for Type 2 sound-level meters. For initial surveys to detect potentially hazardous areas or where noise levels are constant, the sound-level meter works very well. But where the noise levels vary, the sound-level meter may be unsatisfactory. Here the operator must not only measure more than one noise level (with the probability of several different range settings), he must also time the duration of each level so that the total combined noise exposure (C_T) can be calculated. This procedure could mean continuous measurements and recordings over an 8-hour period — a difficult and time-consuming task, prone to data-transcription or calculation errors.

A better way to make such measurements is automatically — simply push a button at the end of the day for the results. That is the philosophy behind General Radio's 1934 and 1944 Noise-Exposure Monitors. The 1934 Noise-Exposure Monitor is designed for use in areas where sound-level measurements are to be made *in situ*. Where measurements for a worker who moves about during the day are to be made, the wearable dosimeter, GR's 1944 Noise-Exposure Monitor, should be selected.

For impact sounds which cannot be measured satisfactorily with a conventional sound-level meter, the 1556-B Impact-Noise Analyzer can be operated from the output of a GR sound-level meter or octave-band analyzer to measure noises produced by punch presses, forging hammers, pile drivers, and similar equipment.



The sound-level meter gives a quick check. If the noise from the machine is over 90 dB(A) this safety officer knows immediately that further measurements are necessary to be sure OSHA limits are not exceeded.

1565-B and 1563 Sound-Level Meters

- 40-to-140 dB range
- meet ANSI and IEC standards
- rugged ceramic microphones
- FET and integrated-circuit design combine performance with reliability
- convenient pocket proportions — small and light

The best of both worlds The 1565-B is a full-fledged standard sound-level meter — it conforms to both national and international standards, meets all criteria necessary for the noise provisions of the Occupational Safety and Health Act, and includes most of the features usually found in larger, more cumbersome, and more expensive instruments. Yet the 1565-B fits in the palm of your hand and operates in severe environments for up to 50 hours on self-contained batteries. There are no line cords to bother with or microphone cords to trip over, and an imaginative combination of controls permits one-hand operation and rapid interpretation of the result — just aim and read.

The 1565-B is the successor to the 1565-A, long popular for rapid measurements of plant, traffic and community noise.

The -B version is a total redesign to take advantage of the experience gained with its predecessor and of the latest advances in component and techniques — it is smaller, 40% lighter, and easier to use. It offers 50% longer life on batteries that are readily available. In common with the 1565-A, the 1565-B is approved by the Bureau of Mines for use in gassy coal mines.

Performance and versatility built-in The 1565-B uses a rugged, yet laboratory-quality, ceramic microphone that can be checked easily, when necessary, by such standard calibration devices as the GR 1562 Sound-Level Calibrator. An output jack is provided for use with headphones or recorders, and a lock is provided so the range control can be fixed in a single position. The instrument is housed in a tough plastic case, tapered at the microphone end to reduce the effects of case diffraction, and meets all ANSI requirements for a Type 2 general-purpose sound-level meter.

The 1563 is similar to the 1565-B but is designed to meet the less stringent requirements for ANSI Type 3 survey meters. Other differences include a pressure-calibration restriction to 1000 Hz and the inability to be adapted for use with vibration transducers, an external microphone, or microphone windscreens.

SPECIFICATIONS

Sound Level: 40 to 140 dB re 20 μ N/m².

Weighting: A, B, and C. 1565-B conforms to ANSI S1.4-1971 Type 2 and IEC 123,1961. 1563 conforms to ANSI S1.4-1971 Type 3.

Meter: Rms response with fast and slow speeds.

Input: MICROPHONE: Lead-zirconate-titanate ceramic. For 1565-B, a 1560-P96 Adaptor converts input to 3-pin male A3 connector; for correct weighting, source impedance must be 380 pF \pm 5%. **INPUT IMPEDANCE:** \approx 13 M Ω //15 pF.

Output: \geq 1.2V rms behind 620 Ω with meter at full scale; will drive 1556 Impact-Noise Analyzer, 1558 Octave-Band Noise Analyzer, 1521 or 1523 recorders, oscilloscopes, or low-impedance headphones. **HARMONIC DISTORTION:** \leq 0.5% (0.1% typical) from 32 Hz to 8 kHz, C-weighted with meter at full scale.

New Since
Catalog U



1565-B Sound-Level Meter
Type 2



1563 Sound-Level Meter
Type 3

Calibration (with 1562 Sound-Level Calibrator): 1565-B can be acoustically calibrated at 125, 250, 500, 1000, and 2000 Hz; at 1000 Hz only for 1563.

Environment: TEMPERATURE: -10 to +50°C operating; -40 to +60°C storage, with batteries removed. For 1565-B, coefficient of sensitivity = +0.02dB/°C at 6 dB below full-scale meter reading. **HUMIDITY:** 90% RH. **MAGNETIC FIELD:** 1-Oersted (80 A/m) 50- or 60-Hz field causes \approx 45 dB C-weighted indication when meter is oriented to maximum sensitivity to field.

Supplied: Carrying pouch, miniature phone plug to connect to output, screwdriver for calibration adjust, batteries.

Available: For 1565-B only, when used with 1560-P96 Adaptor: 1560-P52 VIBRATION PICKUP, 1560-P73 or -P73B EXTENSION CABLE for remote microphone connection.

Power: Two 9-V batteries (Burgess 2U6 or equal) supplied, provide \approx 50-h operation.

Mechanical: Shielded plastic case. **DIMENSIONS (wxhxd):** 1565-B, 3.63x6.5x2.09 in. (92x165x53 mm); 1563, 3.63x5.38x2.09 in. (92x137x53 mm). **WEIGHT:** 1 lb (0.5 kg) net, 3 lb (1.4 kg) shipping.

Description	Catalog Number
1565-B Sound-Level Meter	1565-9702
1563 Sound-Level Meter	1563-9701
Windscreens for 1-in. microphone on 1565-B only, reduce wind noise and protect against contaminants, pack of 4	1560-9521
Battery, spare (2 req'd for each SLM)	8410-3200

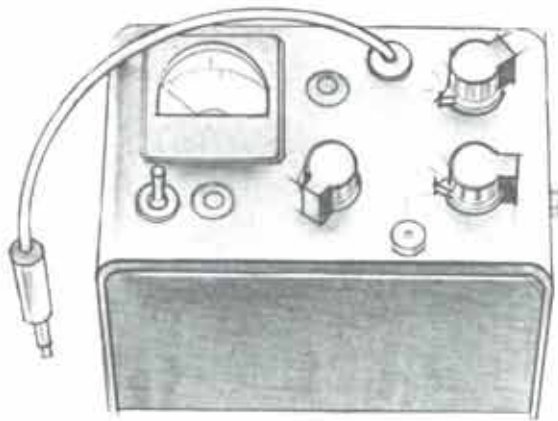

1556-B Impact-Noise Analyzer

- measures electrical and acoustical noise peaks
- stores transient peak and time-average values
- 50- μ s rise-time response

This device evaluates the characteristics of impact-type sounds and electrical noise impulses, which cannot be satisfactorily measured with conventional noise-meters.

Impact noises include those produced by punch presses, forging hammers, fire alarms, pile drivers, office machinery, and similar equipment. From the standpoint of hearing damage, some of these sounds constitute a serious problem for industry. They have hitherto been measurable only by complicated methods employing oscilloscopes.

The two characteristics of impact sounds that seem most significant are the peak amplitude and the duration, or decay time. This analyzer measures the:

- **peak value**, the maximum level reached by the noise
- **"quasi-peak"**, a continuously indicating measure of the high levels reached just before the time of indication
- **time-average**, a measure of the average level over a predetermined period of time, which, when subtracted from peak level, is a measure of the duration of the impact

For these applications, the Impact-Noise Analyzer operates from the output of a GR 1551 or 1565-B Sound-Level Meter, a 1933 Precision Sound-Level Meter and Analyzer, or a tape recorder. It measures sound or vibration impacts, depending upon the transducer.

Electrical noise peaks in a wire communication circuit can be measured with this instrument as one of the tests to determine the adequacy of the circuit for transmitting data pulses. In such measurements, many peaks may be measured in a short time, and, after each peak, the stored signal must be erased before the next pulse occurs. To facilitate this a Reset pushbutton is provided, which can also be operated by an ordinary camera cable release.

Circuit A battery-operated, degenerative, transistor amplifier simultaneously drives three ac voltmeter circuits, which comprise rectifiers, storage capacitors, and a dc electronic voltmeter. The electrical storage system (a capacitor charged by a rectifier) makes it possible to

The 1556-B Impact-Noise Analyzer attaches to the 1551-C Sound-Level Meter as shown here.



measure three characteristics of an impulse — peak, quasi-peak, and time-average — with a single meter, at the turn of a switch.

SPECIFICATIONS

Input: Any voltage from 1 to 10 V for normal range. Inputs below 1 V reduce the range of reading.

Input Impedance: Between 25,000 and 100,000 Ω , depending on the setting of the Level control.

Frequency Range: 5 Hz to 20 kHz.

Level Indication: Meter calibrated in dB from -10 to +10. Attenuator switch increases range by 10 dB.

Peak Reading: Rise time is less than 50 μ s for a value within 1 dB of peak value (for rectangular pulses). Storage time at normal room temperature is greater than 10 s for a 1-dB change in value.

Quasi-Peak Reading: Rise time of less than $\frac{1}{4}$ ms and decay time of 600 \pm 120 ms for rectifier circuit.

Time-Average Reading: Charge time of rectifier circuit selected by seven-position switch, having times of 0.002, 0.005, 0.01, 0.02, 0.05, 0.1, and 0.2 s for the resistance-capacitance time constant. Storage time at normal room temperature is greater than 1 min for a 1-dB change in value.

Input Terminals: Cord with phone plug at one end.

Required: A sound-level meter, analyzer, or other calibrated amplifier to supply input for 1556.*

Batteries: One 1 $\frac{1}{2}$ -V size-D flashlight cell and one 45-V battery (Burgess XX30 or equivalent) are supplied. Typical battery life is 100 h.

Mechanical: Aluminum cabinet with leather carrying case supplied. Cabinet can be fastened directly to end of 1551 Sound-Level Meter. DIMENSIONS (wxhxd): 7.5x6.5x4.5 in. (190x165x114 mm). WEIGHT: 4.5 lb (2.1 kg) net, 12 lb (5.5 kg) shipping.

Description	Catalog Number
1556-B Impact-Noise Analyzer \oplus	1556-9702
Set of Replacement Batteries	8410-9590

\oplus Federal stock numbers are listed before the index.

*1560-P80 (1560-9680) Adaptor Cable required with 1556-B.



1934 Noise-Exposure Monitor

New Since
Catalog U

- automatically and accurately measures noise exposure (level/time)
- conforms to OSHA, ANSI, and IEC requirements
- clear display, simple control
- compact, reliable, tamper proof
- outputs for automatic permanent records

Noise — a matter of health and the law Excessive noise has long been a concern of physicians, public-health organizations, and employees and employers alike — now it's a concern of the law as well. The 1970 Occupational Safety and Health Act* specifies maximum exposures to noise beyond which it is generally recognized that a person's health and efficiency suffer. Measurements of such exposure involve the duration of exposure in addition to the sound levels encountered and have been difficult in the past — fraught with the complexities of trained personnel and time-consuming calculations.

Simplified measurements — automatic and unattended The 1934 measures noise exposure in accordance with applicable OSHA, ANSI, and IEC requirements and does so with such simplicity that only a finger and an ability to read are required. Instead of a sound-level meter, recorder, and desk calculator to make measurements, you need only the 1934. Simply plug it in and push a button

* OSHA applies to those engaged in interstate commerce.

to select the hours of test time (8 choices are available, from 8 hours to 17 hours). You can then go about your normal routine, return after the 1934 has automatically completed the measurement and read the answer directly in exposure from 0 to 990% where 100% is the maximum legally allowed.

The 1934 accepts noise information from a microphone or sound-level meter, samples the information approximately twice a second, categorizes and weights it according to its sound level, and displays percent of noise exposure or percent of test time as selected by panel pushbuttons. The data are also available as electrical signals at the rear panel for use by recorders, printers, and other useful auxiliary instrumentation.

SPECIFICATIONS

Noise-Level Exposure: Maximum permissible exposure of 100% in accordance with OSHA is accumulated for any of the following noise exposures:

Sound Level	Exposure	Sound Level	Exposure
90 to 92 dBA	6 hours	100 to 102 dBA	1.5 hours
92 to 95	4	102 to 105	1
95 to 97	3	105 to 110	0.5
97 to 100	2	110 to 115	0.25

When the daily noise exposure is composed of two or more periods of noise exposure of different levels, their combined effect is considered. The indicated answer on the front panel of the instrument is the sum of the following fractions: $(C_1/T_1 + C_2/T_2 + \dots + C_n/T_n) \times 100$, where C_i indicates the total time of exposure at a specified noise level and T_i indicates the total

time of exposure *permitted* at that level (the multiplier 100 converts the results to a percent rather than a decimal fraction). If this indicated answer exceeds 100, then the mixed exposure should be considered to exceed the limit value. Measuring circuits meet ANSI Standard S1.4-1971 Type 2 and IEC Publications 123-1961 and 179-1965 for A-weighted, slow-response circuits. The "A" in "dBA" refers to this weighting.

Measurement Times: 8 pushbutton-selected times, for 60-Hz line, of 8, 8.25, 8.5, 8.75, 9, 16, 16.5, and 17 hours. A Pause pushbutton interrupts measurement when pushed and allows it to resume when released. Measurement stops and results are stored for display when % Limit reaches 99% or when elapsed time of measurement reaches that set by pushbuttons.

Display: DIGITAL: 3 high-intensity neon readout tubes display % of noise exposure accumulated or % of elapsed measurement time as selected by pushbutton. LAMPS: Indicate test complete, 115 dBA exceeded and 140 dB peak (operates only with microphone input) exceeded.

Input: MICROPHONE connects to rear 3-pin type A3 mike jack which also supplies power (+16 V at 20 mA) to 1560-P40 or -P42 Preamplifier. SOUND-LEVEL METER connects to rear phone jack; ±9 V at 20 mA available at rear 5-pin type 126 jack to power sound-level meter.

Interface: DISPLAY: Three 8-4-2-1 BCD digits provide same data as display at standard DTL or TTL levels (positive true, logic 0 = ground, 10-mA sink; logic 1 ≥ +3.5 V). DIGITAL LEVEL: 8 lines, one for each specified level. Logic 1 means level exceeded. ANALOG LEVEL: 5 mA (<90 dBA) to 0 mA (≥110 dBA) with 7 intermediate values for corresponding dBA levels; available at rear miniature phone jack. CONNECTOR: All signals except analog level available at rear double 15-pin etched-board terminals.

Environment: TEMPERATURE: 0 to +55°C operating, -40 to +75°C storage. HUMIDITY: 95% RH and +40°C. VIBRATION: 0.03 in. from 10 to 41 Hz, 0.01 in. from 41 to 55 Hz. BENCH HANDLING: 4 in. or 45° (MIL STD-810A-VI). SHOCK: 30 g, 11 ms.

Supplied: 5-pin type 126 plug, phone plug and miniature phone plug, double 15-pin etched-board connector, power cord.

Available: 1562 SOUND-LEVEL CALIBRATOR, data printer and recorder. 1934-P1 SECURITY CASE, tamper-proof with lock, completely encloses exposure monitor and 1560-P6 Microphone, includes threaded stud to secure monitor. 1934-9601 ACCESSORY CABLE for connection to MFE model M-12 or M-12B recorder; recorder available from MFE, Keewaydin Drive,

The 1934-P1 Security Case with cover swung back to show the 1934 mounted in place.



Salem, NH 03079; 6 in./h chart speed recommended. 1934-9602 ACCESSORY CABLE for connection to MFE model DP6/4 (1996372) three-column data printer.

Power: 100 to 125 or 200 to 250 V, 50 to 60 Hz, 25 W max.

Mechanical: Convertible-bench cabinet. DIMENSIONS (wx hxd): 1934, 8.5x5.25x8.25 in. (216x133x210 mm); 1934-P1, 12.13x9.25x11 in. (308x235x279 mm). WEIGHT: 1934, 9.5 lb (4.4 kg) net, 13 lb (6 kg) shipping; 1934-P1, 6.5 lb (2.5 kg) net, 11 lb (5 kg) shipping.

Description	Catalog Number
1934 Noise-Exposure Monitor	
Without microphone	1934-9700
With 1560-P6 microphone	1934-9701
1934-P1 Security Case, for tamper-proof installation	1934-9600
1560-P76 Patch Cord, 3 ft with phone plugs, to connect to any GR sound-level meter	1560-9676
Accessory Cable for MFE M-12 or M-12B recorder	1934-9601
Accessory Cable for MFE DP6/4 (1996372) data printer	1934-9602
Windscreen, for 1-in. microphone, per pack of 4	1560-9521

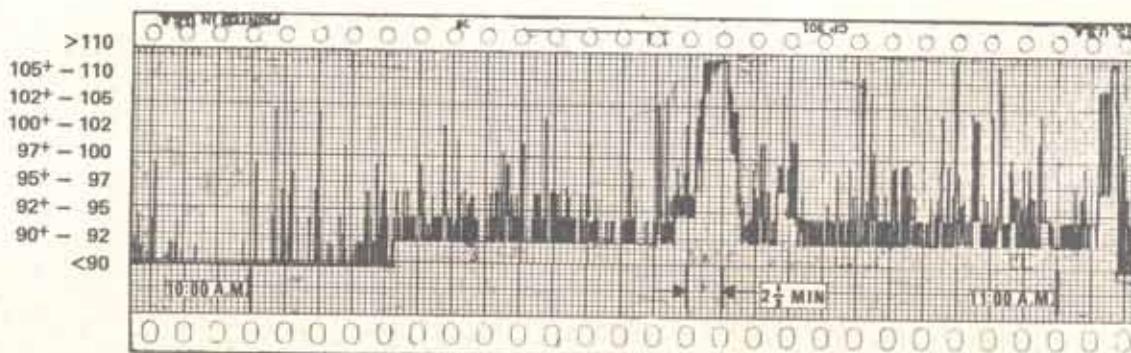

An actual strip-chart record made using the MFE accessory recorder with the Noise-Exposure Monitor in the course of an hour at a noisy work station. The cumulative noise exposure at this station was 110% for the 8-hour day. From the plot it can be readily determined that 13% of the permitted daily exposure occurred between 10:33 and

10:35 (2 minutes divided by 15 minutes allowed, at levels between 110 and 115 dBA.) Note: a reduction of that 2-minute portion below 90 dBA would make the total day's exposure 97% (within the legally acceptable limit).



1944 Noise Dosimeter

... consists of Monitor and Indicator as follows

1944 Noise-Exposure Monitor

- small, shirt-pocket size
- light weight, 7½ oz
- tamper-proof
- built-in mike
- conforms to applicable portions of ANSI S1.4-1971, Type 2 Sound-Level Meters
- long battery life—300 hours

Measuring true accumulated noise exposure The requirements of the Occupational Safety and Health Act for measuring employee noise exposure are not always met by single measurements of noise levels at various work areas. Many people tend to move about during their workday and noise levels vary from area to area. General Radio offers you an instrument that measures the individual's noise exposure, precisely. The 1944 Noise-Exposure Monitor, a small, lightweight instrument (7½ ounces), is worn by the worker and moves with him during the entire workday.

Powered by a single 9-V battery, this monitor detects noise with its built-in microphone, weighs it and accumulates the total noise exposure for the workday, based on



New

OSHA criteria. Exposure to levels in excess of 115 dBA is also detected and the fact is stored by the 1944. At the end of the day, readout on a separate instrument provides you with the accumulated data.

The monitor performs its measurements with absolutely no effort on the part of the employee. Of equal importance, its light weight and small size permit it to be worn with no hindrance to his work. The microphone is built in, so there are no exposed wires or separate microphones to snag, break or possibly foul in moving equipment. Tamper-proof operation is assured, since there are no displays or controls on the unit. A concealed on-off switch is activated by a pin, normally controlled by the supervisor of the noise measurement program. The pin also serves to lock the battery in place, a single 9-V battery that lasts for about 7 weeks of daily use.

1944 Noise-Exposure Indicator

- only one required for any number of monitors
- built-in sound-level calibrator checks complete system including microphone
- reads to 999%
- readout available only to authorized persons
- all electronic, including bright light-emitting-diode display—no moving parts
- battery operated

Displaying accumulated noise-exposure levels Retrieving the information (detected and stored in the 1944 Noise-Exposure Monitor) is accomplished with ease; you use the 1944 Noise-Exposure Indicator. At the end of the workday, simply plug the pocket-sized Monitor into the Indicator, press a button, and look at the light-emitting-diode readout. The number displayed there represents

SPECIFICATIONS

1944 NOISE-EXPOSURE MONITOR See previous page.

Noise-Exposure Time: Maximum permissible exposure time of 100% in accordance with Occupational Safety and Health Act (Public Law 91-596) is accumulated for the following alternatives, or a pro-rata combination of these:

Sound Level, A-Weighted, Slow Response	Exposure
90 dB	8 hours/day
95	4
100	2
105	1
110	0.5
115	0.25

Sound level is interpolated between the above points. The integrator cuts off sharply below 90 dBA. **STORAGE:** Data representing total noise-exposure time accumulated, in percentage of legal limit; also the fact of whether the 115 dBA limit has been exceeded. Accumulation can be stopped by switching within Monitor; but data are held for shelf life of battery or until memory is reset to zero by action of 2 buttons in the indicator.

Sound-Level Range: 90 to 115 dBA (re 20 μ N/m²).

Weighting: "A" in accordance with ANSI Standard S1.4-1971 Type 2 and IEC Publication 123, 1961.

Accuracy at 115 dB, 1 kHz: At 23°C, ± 0.5 dB; over the temperature range -10 to $+50$ °C (14 to 122°F), ± 1 dB. **LINEARITY:** ± 0.4 dB at 1 kHz from 90 to 115 dBA with reference to the 115-dBA level. **STANDARDS:** Satisfies all applicable sections of ANSI S1.4-1971 for Type 2 sound-level meters, including acoustical, amplifier, weighting and detection specifications. **DETECTOR:** * True rms response with "slow" speed in accordance with ANSI S1.4-1971, IEC Publication 123, 1961 and the Occupational Safety and Health Act. Crest-factor capacity at full scale (115 dBA) is greater than 15 dB.

Microphone: Ceramic type.

Environment: TEMPERATURE: -10 to $+50$ °C (14 to 122°F) operating, -40 to $+60$ °C storage with batteries removed. HUMIDITY: Up to 90% RH at 40°C.



the accumulated percentage of noise exposure a worker has experienced . . . 100% being the maximum permissible in accordance with OSHA. A lamp on the Indicator lights in the event that 115 dBA has been exceeded at any time during the monitored period.

The 1944 indicator unit also provides acoustic-calibration verification as well as a check of battery condition. Pushing two buttons resets the memory in the Monitor to zero, ready for the next day's use.

Power: One 9-V battery (Burgess 2U6 or equivalent) supplied, provides about 300 h operation.

Mechanical: Shielded metal case. DIMENSIONS (wxhxd): 2.2x4.9x0.9 in. (56x124x23 mm). WEIGHT: 7.5 oz. (0.21 kg) net, 2 lb (1 kg) shipping.

1944 NOISE-EXPOSURE INDICATOR

Readout of data stored in 1944 monitor: Non-destructive. EXPOSURE TIME: 1% to 999% of legal limit, on light-emitting-diode display in 1% steps; 999% for any accumulation exceeding this amount. 115 dBA EXCEEDED: A light shows if 115 dB A-Weighted sound level was exceeded during the monitored workday.

Calibration: A sound-level calibrator (integral part of the Indicator) produces a 1-kHz sound for a period of 45 s at the proper level to provide a noise-exposure accumulation of 5%. **BATTERY CHECK:** A meter is provided for checking batteries in the Monitor and Indicator units.

Environment: TEMPERATURE: -10 to $+50$ °C (14 to 122°F) operating; -40 to $+60$ °C storage with batteries removed. HUMIDITY: Up to 90% RH at 40°C.

Power: Four 1.5-V "C" cells supplied, provide 20 h continuous duty (at least 1 button held down). **NORMAL SERVICE LIFE:** >6 months.

Mechanical: DIMENSIONS (wxhxd): 11x7.3x2.1 (279x186x54 mm). WEIGHT: 3.9 lb (1.8 kg) net, 6 lb (2.8 kg) shipping.

Description	Catalog Number
1944 Noise Dosimeter, includes Monitor and Indicator in Storage Case	1944-9700
1944 Noise-Exposure Monitor	1944-9701
Spare Battery (monitor uses 1)	8410-3200
1944 Noise-Exposure Indicator	1944-9702
Spare Battery (indicator uses 4)	8410-1500

* Patent Pending



Sound-Level Measurement Sets

New

- measure noise levels
- calibrate "on the spot"

Convenient combination The GR sound-level measurement set is a practical buy for the person who needs to make sound-level measurements and wants to make his own periodic routine calibrations. Three versions of the set are offered, each containing a sound-level meter and a sound-level calibrator. The performance characteristics of each version are determined by the individual instruments in the set, as follows:

The 1565-B Sound-Level Meter meets ANSI Type 2 Standards. The 1563 Sound-Level Meter meets the less-stringent Type 3 standards.

The 1562-A Sound-Level Calibrator provides 5 frequencies, enabling you to test frequency response as well as to calibrate at a standard level. The 1567 Sound-Level Calibrator tests at 1000 Hz, for calibration of level only.

Both instruments in each set are battery operated to provide truly portable sound-level measurements and calibration in a convenient, easily carried package. The carrying case has the added advantage of keeping both instruments together in a single package. The calibrator is therefore readily available for on-the-spot calibration of the sound-level meter.

SPECIFICATIONS

1563-9903 Sound-Level Measurement Set: 1563 Sound-Level Meter, 1567 Sound-Level Calibrator, carrying case, batteries, screwdriver for calibration adjust, miniature phone plug that connects to sound-level-meter output.

1565-9902 Sound-Level Measurement Set: 1565-B Sound-Level Meter, 1562-A Sound-Level Calibrator, carrying case, batteries, screwdriver for calibration adjust, miniature phone plug that connects to sound-level-meter output.

1565-9903 Sound-Level Measurement Set: 1565-B Sound-Level Meter, 1567 Sound-Level Calibrator, carrying case, batteries, screwdriver for calibration adjust, miniature phone plug that connects to sound-level-meter output.

Mechanical (any set): DIMENSIONS (wxhxd): 11.25x4.25x10 in. (286x108x254 mm). WEIGHT: 4.5 lb (2.1 kg) net, 12 lb (6 kg) shipping.

For all other specifications, refer to the individual descriptions of the instruments in these sets.

Description	Catalog Number
1563-9903 Sound-Level Measurement Set	1563-9903
1565-9902 Sound-Level Measurement Set	1565-9902
1565-9903 Sound-Level Measurement Set	1565-9903

Hearing Testing

The goal of any hearing conservation program is, of course, the protection of employee hearing. It follows, then, that the success of the program can be monitored directly by repeated measurement of employee hearing. If the program is successful, employee hearing is not impaired. If noise hazards do exist, the onset of hearing losses can be detected before they become serious, and the offending hazards can be eliminated. Documentation of new-employee hearing tests can serve to prevent claims for hearing losses actually incurred prior to employment. Similarly, preplacement hearing tests are advisable to evaluate an employee's hearing prior to relocation in a potentially high-noise area.

The tool for hearing measurements is the audiometer, an instrument that measures an individual's hearing threshold as a function of frequency. Three broad categories of audiometers are available: 1. Monitoring audiometers to detect whether persons have a hearing loss or defect. 2. Diagnostic audiometers for professional audiologists to diagnose hearing losses and to determine the type of corrective action necessary. 3. Research audiometers for use by medical specialists such as audiologists and otologists to conduct basic research into the hearing mechanism and to develop new techniques for curing speech and hearing defects. Inquiries about research and diagnostic audiometers should be directed to Grason-Stadler.

The type of audiometer usually preferred in a hearing-conservation program is the monitoring audiometer. Again, as with noise-measurement instruments, there are two basic choices of the type of monitoring audiometers available — automatic and manual; the economics of the choice depend largely on the magnitude of the task.

The G-S 1703 Recording Audiometer is an automatic audiometer that has won the endorsement of most authorities. It performs the necessary measurements rapidly, produces highly repeatable results, and does not require constant attention by the operator — the employee tests himself after only a minimum of preliminary instructions. Because the instrument produces an audiogram automatically during the test, its validity is less likely to be challenged than that of an audiogram plotted manually after the test is completed, as is done with manual audiometers.

The audiometric examination room is another important aspect of employee-hearing measurements. Quiet is necessary because background noise can seriously influence the employee's response and, therefore, the test results. In very rare cases, a sufficiently quiet area of the plant or office can be found in which to perform the tests. In most cases, however, such areas are non-existent and a special acoustically treated room must be built or purchased.

Since the noise levels inside the room must be below the threshold of hearing, careful design and construction techniques are necessary to achieve the necessary noise-reduction efficiencies. Walls and roof should be two to four inches thick, constructed of material with a high degree of acoustic absorption and sheathed in sheet steel. Silencers must be employed on ventilator inlets and outlets, and it is advisable to have the entire structure mounted on elastomer vibration isolators. In addition, for acceptable test results, such enclosures should meet the various applicable standards including ASTM E90-61T and ANSI Z24.19-1957, S3.1-1960 and S1.1960. GR offers its 1939 Audiometric Examination Room and 1938 Sound Shelter, both of which meet these standards.

1938 and 1939 Quiet Rooms



New Since Catalog U

GR 1939

- high attenuation, for noisy areas
- roomy interior
- several options — vent fan, shelf



New Since Catalog U

GR 1938

- moderate attenuation
- fits through a 30-in. doorway
- economically priced, with vent fan

Essential silence For valid audiometric tests, it is essential that background noise be kept to an absolute minimum and the best way to achieve this is by means of an audiometric booth. Among the best available are those manufactured by the Industrial Acoustics Company for General Radio.

The booths described here meet applicable OSHA requirements. You will be pleased with the quality of construction. The large, smooth-operating doors are completely safe, even for children, and the generous-sized window helps keep the person inside at ease.

A shelf, available with the 1939 room, is ideal for instrumentation such as the 1703 Recording Audiometer, which otherwise requires a table or bench.

SPECIFICATIONS

GR 1939 Audiometric Examination Room

Frequency ¹	Attenuation ²	Level ³
500 Hz	46 dB	76 dB
1000	53	83
2000	58	95
4000	61	108
8000	63	120

Construction: 4-in.-thick non-combustible steel-faced panels, floor rests on rubber-in-shear vibration isolators, door opens out and leaves 30x75.7-in. clear opening. WINDOW: 24x30 in. of 0.25-in. safety glass with acoustic seal.

Ventilation: Optional 100-CFM roof-mounted forced-air system guaranteed to be below threshold of hearing (ISO-1964); non-protruding discharge silencer.

Mechanical: Modular construction, shipped disassembled. DIMENSIONS (wxhxd): Inside, 40x78x36 in. (102x198x910 cm); outside, 48x91x44 in. (122x31x112 cm). WEIGHT: 1700 lb (770 kg) net.

Description	Catalog Number
1939 Audiometric Examination Room	
With forced ventilation and shelf*	1939-9703
With forced ventilation, no shelf	1939-9701
With outside shelf for audiometer, no fan	1939-9702
Without forced ventilation, no shelf	1939-9700

Larger models also available (48 X 78 X 40 in. inside).

GR 1938 Sound Shelter

Frequency ¹	Attenuation ²	Level ³
500 Hz	38 dB	68 dB
1000	44	74
2000	51	88
4000	52	99
8000	50	107

Construction: 2.5-in.-thick non-combustible steel-faced panels, floor carpeted with 3-ply continuous-filament nylon bonded to 0.19-in. sponge rubber glued to floor, door opens out and leaves 24x66 in. clear opening. WINDOW: 24x30 in. of 0.25-in. safety glass with acoustic seal.

Ventilation: Forced ventilation system with intake and exhaust silencers.

Mechanical: Shipped assembled, fits thru 30-in. doorway. DIMENSIONS (wxhxd): Inside, 24x66x34 in. (61x168x86 cm); outside, 29x75x39 in. (74x191x99 cm). WEIGHT: 650 lb (300 kg) net.

¹ Octave-band center frequency.

² Attenuation (noise reduction) is specified as the difference between the sound-pressure level in a reverberant room outside the booth and that inside the booth; ± 3 dB for instrument accuracy. Measurements conform to ASTM E90-61T and ANSI Z24.19-1957, S3.1-1960, and S1.1-1960.

³ Maximum ambient levels re ANSI S3.1-1960; include a 10-dB safety factor for fluctuating ambient levels. Assistance in site selection for audiometric booths is part of GR's total package approach.

* Normally included in the Industrial Hearing-Conservation Package.

Description	Catalog Number
1938 Sound Shelter , includes forced ventilation	1938-9700

Dimensions exclusive of ventilation hardware.

GENERAL RADIO 1973 CATALOG

G-S 1703 Recording Audiometer

New Since
Catalog U

- rapid automatic audiometric testing
- reduces operator errors
- permanent documentation of test data
- economically priced

Precise records at the push of a button Push the Test button and the 1703 does the rest. It presents seven standard audiometric frequencies sequentially for 30 seconds each, varies the intensity of each until the hearing threshold is reached, and records the results of the entire test on a large, legible chart—all automatically and with no further control manipulation. The automatic approach frees the operator to perform other duties and effectively eliminates operator error since he is not involved in presenting test tones or in recording results.

All seven frequencies are presented first to the left ear and then to the right. After the sequence is complete, a 1-kHz tone is re-presented to the right ear to assess the reliability of the test. At the introduction of each test frequency, the signal intensity changes rapidly until the employee's first response, then more slowly as the threshold is approached. This technique devotes less time to reaching the threshold and more time to defining the threshold precisely, with a resultant increase in the retest reliability and a more meaningful audiogram. The inclusion of an 8-kHz test frequency greatly assists in the discrimination between hearing losses due to presbycusis and those caused by long-term noise exposure.

Fiber-tip pens are available in three colors for easy comparison of an employee's audiograms taken at different times on the same chart; any changes are then clearly visible. Use different colors on, for instance, a pre-employment audiogram and for retesting after one and two years' employment.

— See **GR Experimenter** for October/December, 1970.

The G-S 1703 is one of several audiometers manufactured by Grason-Stadler, a GR Company. For other audiometers, see page 102.

SPECIFICATIONS

Signal: PURE TONE: 7 frequencies automatically and sequentially presented to the left, then to the right, ear: 500 Hz, 1, 2, 3, 4, 6, and 8 kHz, followed by 1-kHz retest of the right ear. **FREQUENCY ACCURACY:** $\pm 3\%$. **TIMING AND CONTROL:** After Test button is pushed, each frequency is presented for 30 s.

Intensity: RANGE: Varies automatically and continuously from -10 to $+90$ dB Hearing Threshold Level (HTL) re ANSI S3.6-

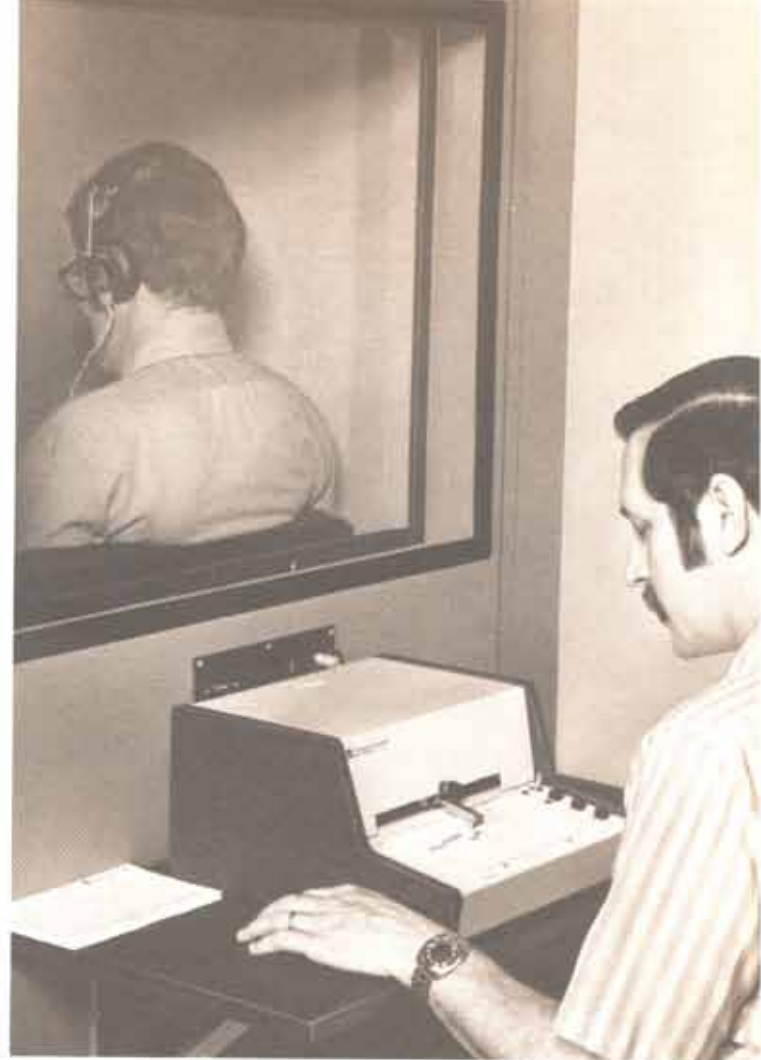
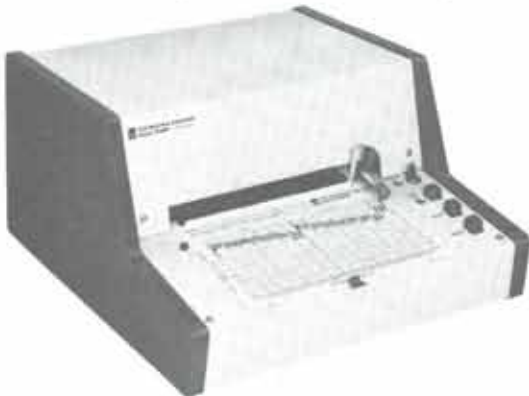

1969 and 1964 ISO Standards. **ACCURACY:** ± 3 dB from 500 Hz to 4 kHz; ± 4 dB above 4 kHz. **TIMING AND CONTROL:** Signal is automatically pulsed 200 ms on and 200 ms off or can be presented continuously. **RATES OF CHANGE:** Automatically programmed, $+10$ dB/s until first employee response, then alternately $+$ and $-$ for each response, as follows: 5 dB/s until 4th response, then 2.5 dB/s (but if employee fails to respond in 5 s, rate returns to 5 dB/s). **FINAL:** At end of test, intensity is reset to min HTL and employee control of intensity is terminated.

Control: Test button initiates test or continues test after stop. Stop button interrupts signals, resets intensity to min HTL. Hold button disables automatic frequency advance, leaving intensity and employee control normal (but permitting operator to change frequency and pen position manually).

Communications: Employee hand switch.

Display: 5x8 in. audiogram of HTL vs frequency, automatically and continuously plotted.

Supplied: Calibrated employee earphones, employee hand-switch, 1000 audiogram forms, 12 blue fiber-tip pens, power and patch cords.

Available: Fiber-tip pens in 3 colors, audiogram forms.

Power: 117 or 234 V, 50 to 60 Hz, 10 W max.

Mechanical: Table-top unit. **DIMENSIONS (wxhxd):** 13x7x14 in. (330x178x356 mm). **WEIGHT:** 12 lb (5.5 kg) net, 20 lb (9 kg) shipping.

Description	Catalog Number
1703 Recording Audiometer	1703-9700
Chart Paper — 500 sheets	1703-9102
Pens, Red — Pkg of 4	1703-9665
Pens, Green — Pkg of 4	1703-9666
Pens, Blue — Pkg of 4	1703-9667

Calibration

An important consideration No matter how well planned a hearing-conservation program may be or how carefully the equipment has been selected, the entire effort can be jeopardized by insufficient evidence that the instruments have been performing properly. Periodic performance checks are therefore advisable and should include all equipment involved in the hearing-conservation program.

Calibration equipment Comprehensive calibrations of the equipment are generally recommended every 6 to 12 months; calibrations can be done only at the manufacturer's service facility or at independent laboratories specializing in such certifications. A daily monitoring check on equipment performance, however, can be accomplished on-site quickly and easily, with a relatively minor investment.

The basic reference is a microphone calibrator that is a source of sound at a precisely known sound-pressure level. Such a calibrator provides a quick check on the accuracy of sound-level meters and noise-exposure monitors used for noise-hazard detection and on sound analyzers used for detailed analyses of the hazard. GR offers both multi-frequency and single-frequency sound-level calibrators in its Types 1562-A and 1567.

Once a sound-level meter has been calibrated, it is ready to check the sound levels in noisy areas and, in conjunction with an earphone coupler, to make checks on an audiometer.

An excellent instrumentation package for field calibrations is the GR 1562-Z Audiometer Calibration Set which includes a microphone calibrator, a sound-level meter (also useful for noise-hazard detection), and an earphone coupler, all neatly packaged in a compact case.



1562-Z Audiometer Calibration Set



The 1562-Z—faulty hearing or faulty audiometer? In 1963 a study¹ revealed that an audiometer only had a 50-50 chance of being accurate. Deficiencies included sound pressure at or beyond tolerance limits, faulty earphone performance, frequency outside limits, excessive harmonic distortion, and extraneous instrument noise.

With this fact in mind the 1562-Z Audiometer Calibration Sets were conceived—mini-systems with maximum benefits for tight budgets. Each contains a sound-level meter and earphone coupler to measure the output level and frequency response of the audiometer, a sound-level calibrator to ensure accurate readings from the sound-level meter, a calibration chart, a full set of instructions, and a convenient carrying case to keep everything together.

Earphone Couplers There are two versions of the calibration set. One includes a 1560-P82 Earphone Coupler and the other a 1560-P83 Earphone Coupler. Both

couplers fit 1-inch-diameter microphones such as GR 1560-P5, -P6, and -P7 microphones and Type L laboratory standard microphones such as the WE 640AA. The calibration set including the 1560-P82 Earphone Coupler is used for calibrating the Telephonics TDH-39 and TDH-49 earphones alone (without muff). The set including the 1560-P83 Earphone Coupler is used for calibrating the same earphones with the earphone cushions (MX-41/AR) left in place. A third coupler, the 1560-P81 Earphone Coupler (available separately), is for 1½-inch diameter microphones such as the older GR 1560-P3 and -P4 microphones, and is similar to the 1560-P82 in all other respects.

— See *GR Experimenter* for May-June 1967 (1562) and Oct. 1966 and April 1968 (1565-Z and earphone couplers).

¹E. L. Eagles, S. M. Wishik, L. G. Doefler, W. Meinick, H. S. Levine, *Hearing Sensitivity and Related Factors in Children*, University of Pittsburgh Graduate School of Public Health. Published by *Laryngoscope*, St. Louis, Missouri 1963.

SPECIFICATIONS

1562-Z AUDIOMETER CALIBRATION SET

Supplied: 1565-B Sound-Level Meter, 1562 Sound-Level Calibrator, earphone coupler, spare batteries, storage case.

Mechanical: DIMENSIONS (wxhxd): 11.25x4.25x10 in. (286x108x254 mm). WEIGHT: 5 lb (2.3 kg) net, 12 lb (6 kg) shipping.

EARPHONE COUPLERS

1560-P81 and -P82: ANSI Type 1.* VOLUME: 6 cm³ including equivalent volume of microphone. AXIAL HOLDING FORCE: 500 grams.



1560-P83: GR 9A (modified version of NBS type 9-A*). VOLUME: 5.642 cm³ including volume added by microphone. AXIAL HOLDING FORCE: 450 grams nominal.



* The 1560-P81, -P82, and -P83 include a microphone locating step for greater ease of use. A series of carefully controlled measurements with both NBS- and GR-type couplers indicates that this minor difference causes no discernible variation in coupler response.

Frequency: 125 Hz to 8 kHz audiometric frequencies; response is equal to that obtained with NBS 9-A coupler within 1 dB to 4 kHz and 1.5 dB to 8 kHz when it is used with TDH-39 or TDH-49 earphone in (for 1560-P83 only) MX-41/AR ear-cushion.

Mechanical: 1560-P81 and -P82: DIMENSIONS: Coupler, 2.25 in. dia x 1.06 in. high (57 x 27 mm); over-all (wxhxd), 2.25 x 3x3 in. (57x76x76 mm). WEIGHT: 0.5 lb (0.3 kg) net, 2 lb (1 kg) shipping. **1560-P83:** DIMENSIONS: Coupler, 2.94 in. dia x 1.25 in. high (75x32 mm); over-all (wxhxd), 2.94x3.5x 3.5 in. (75x90x90 mm). WEIGHT: 0.5 lb (0.3 kg) net, 2 lb (1 kg) shipping.

Description	Catalog Number
1562-Z Audiometer Calibration Set with 1560-P82 Earphone Coupler with 1560-P83 Earphone Coupler, can be used without removing earphone cushions.	1562-9900
1560-P81 Earphone Coupler , ANSI type 1, 1½ in.	1560-9681
1560-P82 Earphone Coupler , ANSI type 1, 1 in.	1560-9682
1560-P83 Earphone Coupler , GR type 9A	1560-9683
Battery , spare for 1565-B (2 required)	8410-3200

1562-A Sound-Level Calibrator

- 125 to 2000 Hz
- ± 0.3 -dB accuracy at 500 Hz
- fits many microphones
- approved by Bureau of Mines



A handful of precision The 1562-A is a self-contained unit for making accurate field calibrations on microphones and sound-measuring instruments. This calibrator fits in the palm of your hand, operates on its own battery power, features a single fumble-free control, and provides a precisely known sound-pressure level at five ANSI-preferred frequencies.

Adaptors supplied with the 1562-A permit calibration of any GR 1 1/4", 1", or 1/2" microphone. Optional adaptors are available to permit calibration of most other standard-size microphones.

An electrical signal output is provided for tests on instruments without microphones, and a built-in indicator lamp checks for adequate battery voltage.

Typical GR Instruments that can be calibrated with the 1562-A are sound-level meters, octave-band analyzers, and sound and vibration analyzers.

SPECIFICATIONS

Acoustic Output: FREQUENCIES: 125, 250, 500, 1000, and 2000 Hz; $\pm 3\%$. SOUND-PRESSURE LEVEL: 114 dB re 20 $\mu\text{N}/\text{m}^2$; accuracy at 23°C and 760 mm Hg is, for WE 640AA or equivalent microphone, ± 0.3 dB at 500 Hz and ± 0.5 dB at

other frequencies; and, for other microphones, ± 0.5 dB at 500 Hz and ± 0.7 dB at other frequencies.

Electrical Output: 1 V $\pm 20\%$ behind 6 k Ω ; flat $\pm 2\%$ with $< 0.5\%$ distortion; available at phone jack.

Environment: TEMPERATURE: 0 to 50°C operating. Temperature coefficient of sound-pressure level is 0 to -0.012 dB/°C; correction chart supplied. HUMIDITY: 0 to 100% RH.

Supplied: Carrying case, adaptors for 1/2- and 1-in. microphones (fits 1 1/4-in. microphones without adaptor), battery.

Available: 1560-9561 COUPLER ADAPTOR SET, for coupling 1562 to 1/8, 1/4, and 1/2-in. microphones. Set is supplied as standard with all GR microphone sets. 

Power: Battery operated (9 V, Burgess PM6 or equal); 120 h use.

Mechanical: DIMENSIONS: 5 in. (127 mm) long x 2.25 in. (57 mm) dia. WEIGHT: 1 lb (0.5 kg) net, 4 lb (1.9 kg) shipping.

Description	Catalog Number
1562-A Sound-Level Calibrator \oplus	1562-9701
Coupler Adaptor Set, adapts 1562-A to 1/8, 1/4, and 1/2-in. microphone	1560-9561
Battery, spare (1 required)	8410-3000

1567 Sound-Level Calibrator

New



Economical Calibration The 1567 Sound-Level Calibrator is specially designed for you who wish to check instrument sensitivity only (not frequency response). The 1567 has a single-level output and is well suited for calibrating the 1563 and 1565-B Sound-Level Meters at 1 kHz.

SPECIFICATIONS

Acoustic Output: FREQUENCY: 1000 Hz, $\pm 3\%$. SOUND-PRESSURE LEVEL: 114 dB re 20 $\mu\text{N}/\text{m}^2$; accuracy (at 23°C and 760 mm Hg) is ± 0.5 dB for 1565-B, ± 1 dB for 1563.

Environment: TEMPERATURE: 0 to 55°C operating. Temperature coefficient of sound-pressure level is zero ± 0.01 dB/°C,

0 to 23°C; -0.017 ± 0.008 dB/°C, 23 to 50°C. Pressure-correction chart supplied. HUMIDITY: 0 to 95% RH.

Supplied: Carrying case, adaptor for 1565-B, battery.

Power: Battery operated, using 9-V Burgess 2U6 or equivalent; 100 h of use.

Mechanical: Cylindrical housing, DIMENSIONS (dia x h): 2.38x 4.44 in. (61x113 mm), WEIGHT: 1 lb (0.5 kg) net, 4 lb (1.9 kg) shipping.

Description	Catalog Number
1567 Sound-Level Calibrator	1567-9701
Battery, spare (1 required)	8410-3200

\oplus Federal stock numbers are listed before the Index.

Product-Noise Reduction

Of the techniques available, control and reduction of noise at its source is the most desirable, if sometimes the most baffling. Fortunately, an ever-growing arsenal of tools is offered to the product designer who must cope with the product-noise reduction problem.

Fundamentally the noise generated by a product can be characterized by three properties or combinations thereof. These are the amplitude, frequency and time distributions. GR instruments are available for the measurement of any of these properties.

Amplitude By far the most frequently used instrument is the sound-level meter whose primary function is the measurement of amplitude. The American National Standards Institute has established three classes of sound-level meters and the International Electrotechnical Commission two classes. GR has instruments meeting the requirements of each class from either organization.

The 1563 is an inexpensive instrument which meets fully ANSI S1.4-1971 Type 3 requirements. The 1565-B and 1551-C meet the provisions of ANSI Type 2 and IEC 143. The new 1933 Precision Sound-Level Meter and Analyzer is a breakthrough in sound-level-meter design. It meets ANSI Type 1 and IEC 179 and includes many automatic features to simplify and speed measurements to precision standards, in the field as well as in the laboratory. A new companion cassette data recorder adds automatic memory to the features of this precision sound-level meter and analyzer.

Frequency Both human response to noise and vibration and the ability to locate its sources are functions of frequency distribution. Frequency-analysis instruments available from GR cover the complete range from those that sequentially examine the spectrum in octave bands to those that can divide the spectrum in as many as 2,000 segments and measure them all continuously.

The 1933 Precision Sound-Level Meter and Analyzer includes an octave-band analyzer covering the standard octave-band center frequencies from 31.5 Hz to 16 kHz. A unique automatic ranging system Opti-Range simplifies the operation of this analyzer.

Most product-noise problems require analysis in 1/3-octave bands. GR offers three systems for performing such analysis. The 1911 provides continuously timed 1/3- and 1/10-octave analysis to meet all provisions of MIL Std 740B. The 1523 with its -P3 plug-in provides fully automatic stepped 1/3-octave analysis while minimizing test time with an optional "constant confidence" mode of operation. The 1921 Real-Time Analyzer can provide a complete, new 1/3-octave spectrum analysis as often as every 1/8 of a second. Use of a digital detection scheme provides true rms measurement of band levels, wide dynamic range, and eliminates the spectrum smearing problems associated with conventional analog approaches.

Some noise and vibration problems require narrower bandwidth of spectral analysis. For such problems the 1910 and 1913 systems offer a choice of fixed (3-, 10-, or 50-Hz) bandwidths and a constant 1% of the center frequency, respectively.

The development of Fast Fourier Transform algorithms has led to a new generation of real-time analysis equipment of unparalleled speed and flexibility. The spectrum can be divided into as many as 8192 segments and updated as often as every 12.2 milliseconds (for 1024 lines). The arithmetic operations embodied in the design of such analyzers are applicable to amplitude and time analysis as well as to frequency analysis. The T/D 1923 Series has the capability of analyzing all three fundamental signal properties; take your choice among the several versions, offering several processing-speed/cost tradeoffs.





1551-C Sound-Level Meter

- general purpose (Type 2)
- 24- to 150-dB measurement range
- meets common standards:
ANSI Standard SI.4-1971
IEC Publication 123, 1961
- 20-Hz to 20-kHz amplifier response
- internal calibration system

The 1551-C is a convenient, highly accurate, general-purpose sound-level meter and is also the key instrument in a wide variety of sound-and-vibration measuring systems. In use as a sound-level meter alone, the 1551 is compact and easy to handle, rugged enough for severe environments, and simple to use.

This highly versatile Type-2 instrument will, for example, serve as a calibrated preamplifier in combination with other, related instruments such as spectrum analyzers, special-purpose microphones, calibrators, and vibration pickups. Many other accessories, such as scopes, headphones, graphic level recorders and tape recorders, can be operated from the sound-level-meter output.

This sound-level meter can also be used as a portable amplifier, attenuator, and voltmeter for laboratory measurements in the audio-frequency range.

Many of its applications are described in detail in the *Handbook of Noise Measurement*, a copy of which is available to each customer.

Description The 1551-C consists of an omnidirectional microphone, a calibrated attenuator, an amplifier, standard weighting networks, and an indicating meter. The complete instrument, including batteries, is mounted in an aluminum case. The microphone can be used in several positions and, when not in use, folds down into a storage position, automatically disconnecting the batteries. An ac power-supply unit is available.

Sound level is indicated by the sum of the meter and attenuator readings. The clearly marked, open-scale meter covers a span of 16 dB.

Absolute acoustic sensitivity is factory calibrated at 500 Hz. Microphone response and sensitivity are measured in a free field from 20 Hz to 15 kHz by comparison with a WE 640AA laboratory-standard microphone with calibration traceable to the National Bureau of Standards. Complete electrical frequency-response measurements are made on each instrument.

The SLM case is fitted with soft rubber feet and amplifier is resiliently mounted for vibration isolation.

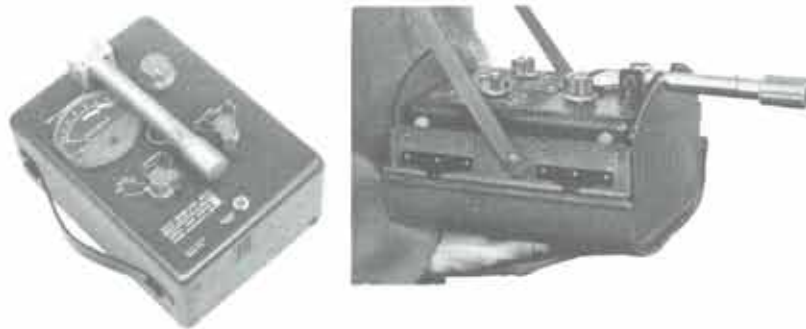

(Left) Microphone in the storage position (batteries automatically disconnected). (Right) The sound-level meter operated in its leather carrying case, microphone in the horizontal operating position.

SPECIFICATIONS

Sound-Level Range: From 24 to 150 dB (re $20 \mu\text{N}/\text{m}^2$).

Frequency Characteristics: Four response characteristics as selected by panel switch. The A-, B-, and C-weighting positions are in accordance with ANSI Standard S1.4-1971 and IEC Publication 123, 1961. Response for the 20-kHz position is flat from 20 Hz to 20 kHz, to complement very wide-band microphones.

Microphone: GR 1560-P5.

Sound-Level Indication: METER: Calibration from -6 to $+10$ dB. ATTENUATOR: Calibrated in 10-dB steps from 30 to 140 dB above $20 \mu\text{N}/\text{m}^2$.

Calibration Accuracy (absolute): ± 1 dB at 500 Hz, in accordance with ANSI standard at all frequencies, when amplifier sensitivity has been standardized (use front-panel adjustment). *Note: The 1562-A Sound-Level Calibrator can be used for making periodic over-all acoustic checks.*

Output: 1.4 V behind 7000 Ω (meter at full scale). HARMONIC DISTORTION (panel meter at full scale): $< 1\%$.

Input Impedance: 25 M Ω in parallel with 50 pF.

Meter: Rms response, fast and slow meter speeds in accordance with ANSI S1.4-1971 and IEC 123, 1961.

Environment: TEMPERATURE AND HUMIDITY: Operating, 0 to 60°C and 0 to 90% RH. (Specifications valid when SLM is standardized and meter indication > 0 dB). Storage, -30 to $+95$ °C and 0 to 100% RH. MAGNETIC FIELDS: Residual

indication ≤ 60 dB (C weighting) in a 60-Hz, 1 oersted (80 A/m) field. ELECTROSTATIC FIELDS: Negligible effect. VIBRATION: Residual indication or signal level < 45 , 60, or 40 dB (C weighting) for vibration vertical, lengthwise, or side-wise, (respectively); shaker amplitude, 0.10 in. pk-pk; any frequency from 10 Hz to 55 Hz; the SLM standing on its feet.

Supplied: Telephone plug.

Available: 1551-P2 LEATHER CASE (permits operation of instrument in case), 1562 SOUND-LEVEL CALIBRATOR, 1560-P95 ADAPTOR CABLE (connects output to 1521-B Level Recorder).

Power: Two $1\frac{1}{2}$ -V size D flashlight cells and one $67\frac{1}{2}$ -V battery (Burgess XX45 or equivalent), supplied.

Mechanical: Aluminum cabinet. DIMENSIONS (wxhxd): 7.25x9.25x6.13 in. (185x235x156 mm). WEIGHT: 7.75 lb (3.6 kg) net, 16 lb (8 kg) shipping, batteries included. Add 2 lb (1 kg) for leather case.

Description	Catalog Number
1551-C Sound-Level Meter	1551-9703
Set of Replacement Batteries	8410-9499
1551-P2 Leather Carrying Case	1551-9602
Windscreen, for 1-in. microphone, pack of 4	1560-9521
Patent Number 3,012,197.	

Ⓜ Federal stock numbers are listed before the Index.

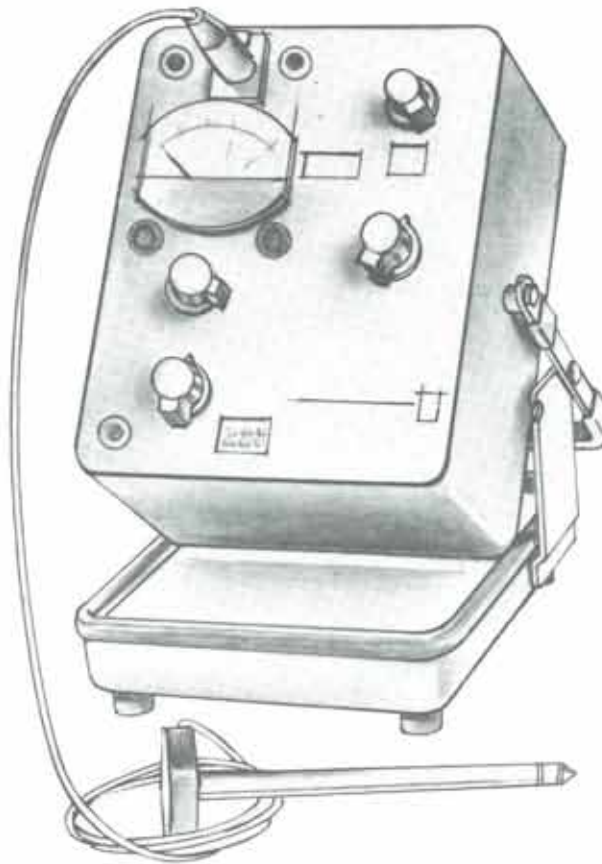

1553 Vibration Meter

- direct reading in acceleration, velocity, displacement, and jerk
- 2 to 2000 Hz (120 to 120,000 rpm) to 20,000 Hz with suitable pickup
- portable, battery operated, simple to use

Vibration in a machine can cause faulty production, premature wear, structural fatigue, and human discomfort and fatigue.

The 1553, portable and simple to use and to read, is well suited to making rapid, repetitive measurements against vibration criteria, such as required in quality control product testing and preventive maintenance programs. With the 1553, periodic measurements of over-all vibration in a machine will quickly show any deteriorating performance trends and lead to early preventive maintenance.

This instrument gives readings in quantities that are physically meaningful: displacement (for clearance problems), velocity (for a criterion in preventive maintenance of machines), acceleration (a measure of the possibility of mechanical failure), and jerk (related to vehicular riding comfort). The 1553-A indicates directly in inches, in./s, in./s², or in./s³.

Its excellent low-frequency response permits the study of the operation of belt drives and of the effectiveness of

mountings designed to reduce vibrations in adjacent structures.

Frequency analysis of vibrations aids in identifying their mechanical sources, diagnosing causes, and measuring the effect of remedies. The GR 1564-A Sound and Vibration Analyzer or the 1568-A or 1900-A Wave Analyzer is of great value in making such frequency analyses.

The 1553 Vibration Meter consists of an inertia-operated, lead-zirconate-titanate ceramic pickup, which delivers a voltage proportional to the acceleration of the vibratory motion; an adjustable attenuator; an amplifier; and an indicating meter. Networks can be switched to convert the output of the vibration pickup to a voltage proportional to displacement velocity, or jerk (time rate of change of acceleration).

Filter jacks on the panel allow the use of external high-pass filters where it is desired to eliminate the frequency components below 30 or 70 Hz.

The vibration meter is portable and is mounted in a Flip-Tilt cabinet, which serves as protective cover and case in transit, and as a base on which the instrument can be operated in almost any position from vertical to horizontal.

Accessories include various tips and a metal probe for the pickup to facilitate measurements in normally inaccessible places. Available at additional cost is the 1560-P35 Permanent-Magnet Clamp, which replaces the probe or tip when measurements are made under conditions where hand-held operation would not be satisfactory.

SPECIFICATIONS

Ranges of Measurement:

Quantity	Peak to Peak	Average	Units	Frequency Range (Hz)
Acceleration	0.3 to 300,000	0.03 to 30,000	in./s ²	2-2000
Velocity	0.03 to 30,000	0.003 to 3,000	in./s	2-2000
Displacement	3 to 300,000	0.3 to 30,000	mils	2-2000
Displacement	0.03 to 30,000	0.003 to 3,000	mils	20-2000
Jerk	30 to 300,000	3 to 30,000	in./s ³	2-20

Accuracy: ±10% of full scale.

Input Impedance: 25 MΩ.

Voltage at Output Jack: 5 V rms, behind 75 kΩ, full-scale.

Attenuators: A 10-step attenuator changes the meter-scale range by a factor of 100,000 to 1. Window readout indicates full-scale values and units (10 times full-scale for Average readings).

Calibration: Internal.

Allowable Pickup Sensitivity, Direct Reading: 30 to 150 mV/g.

Terminals: INPUT: 3-wire audio connector, for pickup cables. OUTPUT: Telephone jack for headphones, one of the many analyzing instruments, or a Strobotac® electronic stroboscope.

Supplied: 1560-P52 Vibration Pickup.

Available: 1560-P35 PERMANENT-MAGNET CLAMP; 1557-A VIBRATION CALIBRATOR, high-frequency pickup 1560-P53, and high-sensitivity pickup 1560-P54.

Power Supply: PORTABLE MODEL: 3 size-D cells and one 67½-V battery (Burgess Type XX45 or equivalent) supplied. Typical battery life, 7 days at 8 h per day. For ac operation, use Type 1262-C Power Supply (listed below). RACK MODEL: Type 1262-C Power Supply is included, no battery.

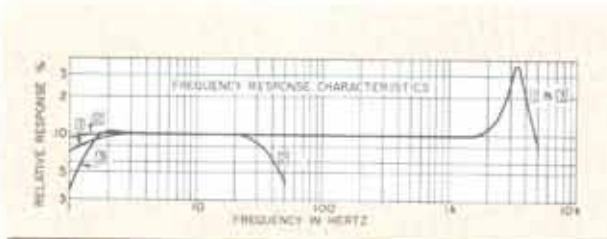

Response characteristics for constant applied (1) acceleration, (2) jerk, (3) velocity, (4) displacement, 2-Hz cutoff, and (5) displacement, 20-Hz cutoff.



Vibration meter with power supply.



Vibration pickup with permanent-magnet clamp

Mechanical: Flip-Tilt case or rack-mounting cabinet. DIMENSIONS (wxhxd): Portable model, 8x9.25x7.5 in. (203x235x190 mm); rack model, 19x10.5x5 in. (483x267x127 mm). WEIGHT: Portable, 10.5 lb (4.8 kg) net, 14 lb (7 kg) shipping; rack, 14 lb (7 kg) net, 31 lb (15 kg) shipping.

Description	Catalog Number
1553-A Vibration Meter	
Portable Model, with batteries *	1553-9701
Portable Model, with 115-V ac supply	1553-9710
Portable Model with 230-V ac supply	1553-9711
Rack Model with 115-V ac supply	1553-9550
Rack Model with 230-V ac supply	1553-9551
Set of Replacement Batteries	8410-9799
1560-P52 Replacement Vibration Pickup	1560-9652
1560-P35 Permanent-Magnet Clamp	1560-9635
Patent Number 3,012,197.	

1262-C Power Supply

The 1262-C Power Supply attaches to the Vibration Meter for ac power-line operation. This power supply is included with rack models or optionally with portable.

Power: 105 to 125 V, 50 to 400 Hz, 3 W, or 195 to 250 V, 50 Hz, 6 W.

Mechanical: Shaped for attachment to Flip-Tilt case. DIMENSIONS (wxhxd): 7.25x9.25x3.25 in. (184x235x83 mm). WEIGHT: 2.25 lb (1.1 kg) net, 8 lb (3.7 kg) shipping.

Description	Catalog Number
1262-C Power Supply	1262-9703

* Federal stock numbers are listed before the index.

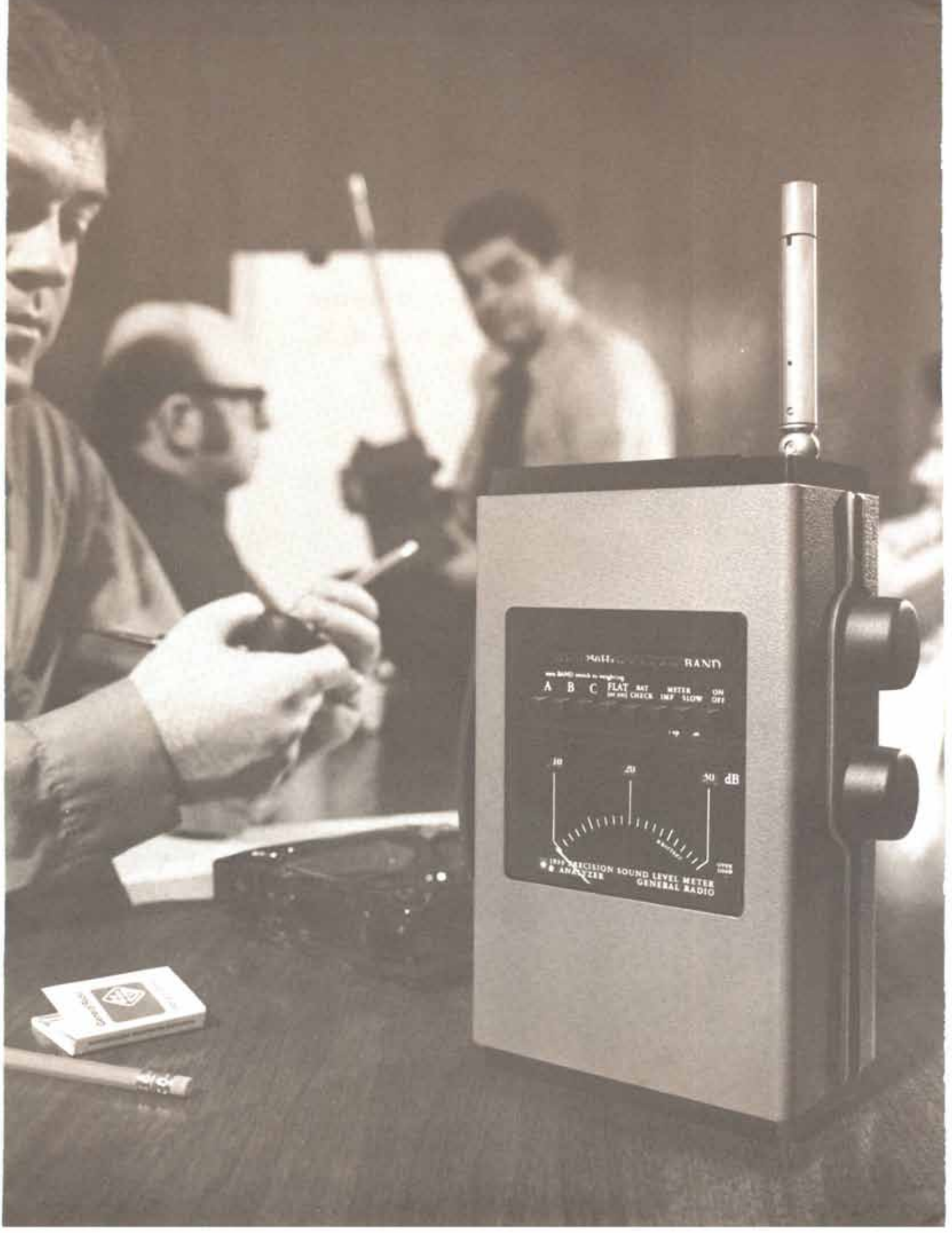

PRECISION SOUND LEVEL METER BAND

new 50dB scale to weighting

A B C FLAT SAT METER ON
100 AND CHECK IMP SLOW OFF

10 20 30 dB

1000

PRECISION SOUND LEVEL METER
ANALYZER
GENERAL RADIO

1933 Precision Sound-Level Meter and Analyzer

New

The 1933 reflects 50 years of GR expertise and leadership in acoustic measurements . . .
. . . it has no equal.

- three instruments in one
 - precision sound-level meter
 - precision impulse sound-level meter
 - octave-band analyzer
- compact, lightweight, and fully portable
- virtually mistake-proof operation with:
 - OPTI-RANGE
 - easy-to-read meter display
 - extendible microphone mast
- can be used with low-cost dc recorders
- compatible with companion cassette data recorder

A precision sound laboratory The 1933 is a precision measuring instrument that conforms to U. S. and international standards for a precision sound-level meter, octave-band analyzer, and impulse sound-level meter. An impact (true peak) measuring capability is also provided. The 1933 measures true rms values (there are no approximations) and automatically warns of invalid readings due to overloads. The complete instrument is in a package one-half the size and weight of conventional analyzers.

An easy-to-use instrument Set the upper knob to Weighting and the 1933 becomes a sound-level meter with a pushbutton choice of A, B, or C weighting or flat response from 5 Hz to 100 kHz. Fast and slow meter speeds are also pushbutton selected. Another button allows impulse testing, according to the proposed amendment to IEC 179, or impact (peak sound-pressure level) testing often used for the measurement of industrial impact noise.

Conversion to an octave-band analyzer is equally simple; turn the knob to the desired octave band — there are 10 to choose from, with center frequencies from 31.5 Hz to 16 kHz.

Virtually mistake-proof measurement A single control is sufficient to set the meter range, even when the instrument is used as an octave-band analyzer. In other analyzers, two are required: An input range control to set the "all-pass" level and an analyzing range control to provide an on-scale meter indication after the desired octave filter has been selected. (Both are necessary to obtain the maximum analyzing range and maximum dynamic range.) But in the 1933 a unique *automatic*

attenuator system is used (OPTI-RANGE). With this feature, you need only set a single range control for an on-scale indication. A second control is provided for situations where the automatic system may not be suitable, as with some measurements of transient signals.

The unusual meter scale also enhances the ease of operation. The meter spans a full 20-dB range, is graduated *linearly* over the entire range, and displays the attenuator setting on the meter face. These features reduce the number of range changes necessary and aid in rapid, error-free interpretation of the readings.

An expandable sound laboratory Often it is desirable to record field measurements for further analysis later in the laboratory. With the 1933 and its companion recorder, the 1935, it is easy to make accurate recordings of such measurements. In addition to an a-signal output to drive one channel of the recorder, the 1933 also provides a level-range-code signal that is stored on a second channel of the recorder. On playback, the level-range setting used for the sound-level meter is indicated by a digital display on the panel of the tape recorder. Thus, the tape stores both data and absolute level information.

A dc output, proportional to the meter deflection (linear in dB), is provided to drive a low-cost dc recorder for hard-copy records of the level vs time. This output has a dynamic range of 40 dB plus an additional 20-dB crest-factor allowance.

Other features The microphones fit atop a telescoping 12-inch extension to reduce the effects of the instrument and operator on the sound field. There is rarely a need for extension cables and tripod. If these are necessary, however, a 60-foot cable and tripod are available. A 10-foot cable is supplied as standard equipment. Measurements are unaffected by the cables because the preamplifier in the 1933 is detachable and connects to the cable at the microphone end, to prevent signal loss.

A complete line of electret-condenser and ceramic microphones can be used with the 1933. Most users will want at least two: The one-half-inch random-incidence microphone, supplied, for smooth high-frequency response and nearly ideal directional characteristics, and the one-inch random-incidence microphone for measurements of very low sound levels. To simplify changing from one microphone to the other, two sensi-



tivity presets are provided in the 1933. You can use two microphones alternately, in a series of measurements, without recalibration; merely turn the sensitivity switch to the position corresponding to the microphone being used.

For field or lab use The 1933 operates for up to 20 hours on self-contained batteries. A companion instrument, the 1940 Power Supply and Charger, allows the analyzer to be operated from the ac line and provides rechargeable batteries and a charging circuit.

Several versions to choose from Four versions of the basic instrument are offered, the difference among them being the number and types of microphones supplied. Versions with flat perpendicular-incidence response microphones are offered for the convenience of customers in those countries (particularly in Europe) where it has become customary to measure with this type of microphone. It should be noted that all versions offered comply with IEC 179.

SPECIFICATIONS

Standards: Specifications meet ANSI S1.4-1971 for Type 1 (precision) Sound-Level Meters; IEC 179-1965 for Precision Sound-Level Meters; IEC 123-1961 for Sound-Level Meters; ANSI S1.11-1966 for Octave, Half-Octave, and Third-Octave Band Type 0 Class II Filter Sets; IEC 225-1966 for Octave, Half-Octave, and Third-Octave Band Filters for the Analysis of Sound and Vibrations; and Proposed IEC 179 amendment for impulse measurement.

Sound Level: 10 to 130 dB re 20 $\mu\text{N}/\text{m}^2$ with 1-in. microphone, 30 to 140 dB with $\frac{1}{2}$ -in. microphone, direct reading.

Frequency: 5 Hz to 100 kHz, essentially flat response. **ANALYSIS:** 10 octave bands with center frequencies from 31.5 Hz to 16 kHz. **WEIGHTING:** A, B, and C.

Display: METER: 20-dB scale linearly marked in dB and lower, center, and upper values automatically indicated on scale. **RESPONSE:** Fast, slow, absolute peak, and impulse (per IEC 179 amendment), pushbutton selected. Precise rms detection for signals with ≤ 20 -dB crest factor at full scale, crest-factor capacity greater below full scale. **OVERLOAD:** Signal peaks monitored at 2 critical points to provide positive panel-lamp warning. **RANGING:** Automatic system (OPTIRANGE) maximizes analyzing range and signal-to-noise ratio for each level range-control setting; manual control provides override. Increment between ranges, 10 dB.

Filters: **WEIGHTING:** A, B, C, and flat; pushbutton selected. **OCTAVE BANDS:** 10, manually selected, with 3.5 ± 1 -dB attenuation at nominal cutoff, > 18 -dB attenuation at $\frac{1}{2}$ and 2X center frequency, > 70 -dB ultimate attenuation. **EXTERNAL FILTERS** can be substituted for internal weighting networks and octave-band filters; connect to 2 miniature phone jacks.

Input: $\frac{1}{2}$ -in. or 1-in. electret-condenser microphone with flat random-incidence response; mounted with detachable pre-amplifier on 12-in. extendible mast, or on 10-ft. extension cable supplied, or on 60-ft. cable available. Input can also be from tape recorder. **INPUT IMPEDANCE:** $1 \text{ G}\Omega \ll 3 \text{ pF}$.

Output: **SIGNAL OUTPUT:** 0.5 V rms behind 600 Ω corresponding to full-scale meter deflection, any load permissible. **RANGE CODE:** Contact closures provide sound-level-meter range information to 1935 Cassette Data Recorder. **DETECTED OUTPUT:** 4.5 V dc behind 4.5 k Ω corresponding to full-scale meter deflection, output is linear in dB at 0.1 V/dB over 60-dB range (40-dB normal range plus 20-dB crest-factor allowance), any load permissible.

Calibration: **FACTORY:** Fully tested and calibrated to all specifications; acoustical response and sensitivity are measured in a free field by comparison with a Western Electric 640AA laboratory standard microphone whose calibration is traceable to the U.S. National Bureau of Standards. **ON-SITE:** Built-in calibrator provides quick test of electrical circuits;



GR 1562 Sound-Level Calibrator is available for simple test of over-all calibration, including microphones.

Environment: **TEMPERATURE:** -10 to $+50^\circ\text{C}$ operating, -40 to $+60^\circ\text{C}$ storage with batteries removed. **HUMIDITY:** 0 to 90% RH. **VIBRATION AND MICROPHONICS:** Conform to applicable ANSI and IEC standards.

Supplied: Microphone attenuator, tool kit, 10-ft microphone extension cable, batteries.

Available: 1940 Power Supply and Charger, electret-condenser microphones, ceramic microphone cartridge and adaptor, earphone, tripod, cables, and windscreens.

Power: 4 alkaline energizer C cells supplied provide ≈ 20 -h operation; 1940 Power Supply and Charger allows line operation of 1933 and includes rechargeable batteries and charging source. Battery check provided on 1933.

Mechanical: Small, rugged, hand-held case with standard 0.25-20-in. threaded hole for tripod mounting. **DIMENSIONS** (wxhxd): 6.25x9x3 in. (159x229x76 mm). **WEIGHT:** 5.5 lb (2.5 kg) net, 10 lb (4.6 kg) shipping.

Description	Catalog Number
1933 Precision Sound-Level Meter and Analyzer (Conforms to IEC 179 and ANSI S1.4-1971, Type I.)	
With $\frac{1}{2}$ -in. and 1-in. flat random-incidence response Electret-Condenser Microphones	1933-9700
With $\frac{1}{2}$ -in. flat random-incidence response Electret-Condenser Microphone only	1933-9701
1933 Precision Sound-Level Meter and Analyzer (Conforms to IEC 179; recommended for Europe.)	
With $\frac{1}{2}$ -in. and 1-in. flat perpendicular-incidence response Electret-Condenser Microphones	1933-9702
With $\frac{1}{2}$ -in. flat perpendicular-incidence response Electret-Condenser Microphone only	1933-9703
Accessories Available	
Electret-Condenser Microphones	
Flat random-incidence response, 1-in.	1961-9601
Flat perpendicular-incidence response, 1-in.	1961-9602
Flat random-incidence response, $\frac{1}{2}$ -in.	1962-9601
Flat perpendicular-incidence response, $\frac{1}{2}$ -in.	1962-9602
Flat perpendicular-incidence response, $\frac{1}{4}$ -in.	1963-9602
Ceramic Microphone Cartridge and Adaptor, 1-in.	1560-9570
Earphone	1935-9601
Tripod	1560-9590
Cables	
Microphone extension cable, 60 ft.	1933-9601
Miniature phone plug to 1933 microphone mast	1933-9602
Miniature phone plug to double banana plug	1560-9677
Miniature phone plug to standard phone plug	1560-9678
Miniature phone plug to BNC	1560-9679
Windscreens, reduce wind noise, protect	
For 1-in. microphone, set of 4	1560-9521
For $\frac{1}{2}$ -in. microphone, set of 4	1560-9522
1562-A Sound-Level Calibrator	1562-9701
Battery, spare for 1933, uses 4	8410-1500
Cassette Data Recorder	1935-9700
Power Supply and Charger	1940-9701

1935 Cassette Data Recorder

New

One of the smallest and most capable data recorders available today.

- excellent companion instrument for the 1933 Precision Sound-Level Meter and Analyzer
- cassette convenience and operating simplicity
- virtually mistake-proof operation with peak monitor for each channel
- record of sound-level-meter attenuator setting

Cassette simplicity The 1935 is a two-channel, two-track magnetic tape recorder with a Philips Cassette format. In use with the 1933 Precision Sound-Level Meter and Analyzer, the 1935 normally records the signal on one channel while on the other it records the setting of the sound-level-meter range control. Thus the signal and range information given on play-back are identical to those available from the sound-level meter at the time of the original recording. Voice notes can also be recorded by interrupting the range code.

Although intended primarily for use with the 1933, the recorder can also be used with any instrument that provides an output of 0.5 to 2 V rms. In this case, the range information is entered manually. If desired, the second channel can record an entirely separate signal, such as the output from a second sound-level meter (in lieu of the range data). Each channel includes a panel monitor that displays the absolute peak level, regardless of polarity, so that recordings are virtually fool-proof.

Included with the 1935 are all necessary accessories — tape, microphone for voice notes, tape-head maintenance set, and interconnecting cables to the 1933.

SPECIFICATIONS

Recording Format: 0.150-in.-wide tape cassette (Coplanar Type CPII), two-channel, two-track.

Normal Recording Duration: 30 minutes using C60 tape. TAPE SPEEDS: 1½ in./s ±2%, electronically controlled; and ¾ in./s.

Inputs: Input impedance at signal input, each channel, 100 kΩ. Signal level corresponding to normal maximum record level is adjustable from 0.5 to 2 V rms. RANGE CODE AND VOICE NOTES: Second channel normally records range code or voice notes simultaneously with data from a sound-level meter. Range code is provided automatically by 1933 Pre-



cision Sound-Level Meter and Analyzer or manually by switch on recorder. Voice-note input has 100-kΩ input impedance and automatic level control.

Frequency Response: ±2 dB from 50 Hz to 12 kHz using GR-supplied cassettes. PLAYBACK EQUALIZATION: NAB (1½ in./s). FLUTTER AND WOW: 0.3% rms as tested in accordance with NAB Standard (April 1965). MAXIMUM SIGNAL TO NOISE RATIO: 50 dB as measured in accordance with NAB standard (range from 2% distortion to A-weighted noise level).

Output (each channel): 0.5 V behind 600 Ω corresponds to normal maximum record level (which allows 10-dB crest-factor capacity). Any load can be connected.

Peak Monitors: Both channels include peak detectors that monitor peaks of both polarities and display on panel meters.

Tape Position Counter: Built-in mechanical counter provides index number for relocating tape position.

Supplied: Head demagnetizer, head cleaning kit, interconnecting cables to 1933 Precision Sound-Level Meter and Analyzer, earphone, microphone for voice notes, cassettes, and batteries.

Power: 5 size-C energizers, supplied, provide about 10 hours' operation. 1940 Power Supply and Charger allows line operation of 1935 and recharges suitable batteries (included with power supply). The regular cells are Eveready E93 or equivalent; the rechargeable cells, Gould National Nicad Type 2.0 SCB, with insulating jacket.

Mechanical: DIMENSIONS (wxhxd): 6.5x10.87x3.56 in. (165x276x90 mm). WEIGHT: 7 lb (3.2 kg) net.

Description	Catalog Number
Cassette Data Recorder	1935-9700
Cassette, 30-minute	1935-9603
Power Supply and Charger	1940-9701
Replacement Batteries	
Regular (5 req'd)	8410-1500
Rechargeable, set of 5 cells	1940-9500

1940 Power Supply and Charger

New

Valuable companion The 1940 allows either the 1933 Precision Sound-Level Meter and Analyzer or the 1935 Cassette Data Recorder to be operated from an ac line, independent of their internal batteries. It is supplied with five rechargeable cells (to replace the ordinary C cells supplied in the analyzer or recorder) and a battery charger. There are no internal connections to make; the instruments simply plug into the 1940 and are supported at a convenient angle for bench-top operation.

SPECIFICATIONS

Power Source: 5 V for line operation of 1933, 6.5 V for line operation of 1935; 250 mA max.

Charging Source: 200 mA max for charging batteries in 1933 or 1935; automatically reduces to ≈ 30-mA trickle charge when batteries are charged. Charging time = 16 h.



Supplied: 5 rechargeable nickel-cadmium C cells to replace non-rechargeable batteries in 1933 or 1935.

Power: 100 to 125 or 200 to 250 V, 50 to 400 Hz, 11 W.

Mechanical: DIMENSIONS (wxhxd): 4.38x4.25x9.44 in. (111x108x240 mm). WEIGHT: 3.5 lb (1.5 kg) net, 5 lb (2.3 kg) shipping.

Description	Catalog Number
1940 Power Supply and Charger	1940-9701

Sound-Analysis Systems

New

The sound analysis systems shown here contain the 1933 Precision Sound-Level Meter and Analyzer and its most commonly used accessories. The carrying cases and accessories are also available separately for those who wish to tailor a set specifically suited to their needs.

1933-9712 Sound-Analysis System This system contains the following instruments and accessories:

- 1933-9700 Precision Sound-Level Meter and Analyzer with ½-inch and 1-inch flat random-incidence-response electret-condenser microphones. It conforms to ANSI S1.4-1971 Type 1 and IEC 179.
- 1935-9700 Cassette Data Recorder with interconnecting cables to the 1933, microphone for voice notes, cassette tapes, earphone, head maintenance and tool kits.
- 1560-9609 Dummy microphone, ½-inch
- 1560-9522 ½-inch windscreen (1 windscreen only)
- 1560-9521 1-inch windscreen (1 windscreen only)
- 1562-9701 Sound-Level Calibrator with adaptors and carrying case
- 1933-9604 Carrying Case (Large)
- 1933-9601 Microphone extension cable, 60 ft.
- 1560-9590 Tripod

Order by Catalog Number 1933-9712.

1933-9713 Sound-Analysis System This system contains the instruments and accessories noted in the 1933-9712 except for the following substitution of microphones: ½-inch and 1-inch flat perpendicular-incidence response electret-condenser microphones. It conforms to IEC 179 and is recommended for European countries. Catalog Number 1933-9713.

1933-9710 Sound Analysis System This system contains the same instruments and accessories as the 1933-9712 less the 1935-9700 Cassette Data Recorder. A 1935-9601 Earphone has been added. Storage space is provided to add the 1935 at a later date. Catalog Number 1933-9710.

1933-9711 Sound-Analysis System This system contains the instruments and accessories noted in the 1933-9710 except for the following substitution of microphones: ½-inch and 1-inch flat perpendicular-incidence response electret-condenser microphones. It conforms to IEC 179 and is recommended for European countries. Catalog Number 1933-9711.

Carrying Case (Large) The system carrying case for the 1933-9713, -9712, -9711 and -9710 systems is supplied with each system but can be ordered separately. Catalog Number 1933-9604.

1933-9714 Sound-Analysis System This system contains the following instruments and accessories:

- 1933-9700 Precision Sound-Level Meter and Analyzer with ½-inch and 1-inch flat random-incidence response electret-condenser microphones. It conforms to ANSI S1.4-1971 Type 1 and IEC 179.
- 1560-9609 Dummy microphone
- 1560-9522 ½-in. windscreen (1 windscreen only)
- 1560-9521 1-in. windscreen (1 windscreen only)
- 1935-9601 Earphone
- 1562-A Sound-Level Calibrator with adaptors (no carrying case)
- 1933-9603 Carrying Case (Small)

Order by Catalog Number 1933-9714.

1933-9715 Sound-Analysis System This system contains the instruments and accessories noted in the 1933-9714 except for the following substitution of microphones: ½-inch and 1-inch flat perpendicular-incidence response electret-condenser microphones. It conforms to IEC 179 and is recommended for European countries. Catalog Number 1933-9715.



1933-9712 Top compartment



1933-9712 Bottom compartment



1933-9714

ence response electret-condenser microphones. It conforms to IEC 179 and is recommended for European countries. Catalog Number 1933-9715.

Carrying Case (Small) The carrying case for the 1933-9714 and 9715 systems is supplied with each system but can be ordered separately. Catalog Number 1933-9603.

1521-B Graphic Level Recorder

- 7 Hz to 200 kHz
- 1-mV ac sensitivity — 0.8-mA dc
- linear dB plot of rms ac-voltage level
- 20-, 40-, or 80-dB range
- convenient, disposable pens

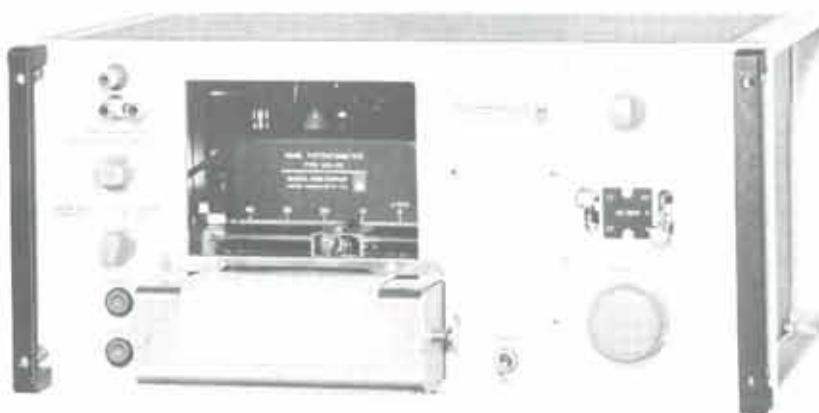

Stands alone This recorder produces a permanent, reproducible strip-chart record of ac-voltage level as a function of time or of some other quantity. Record, for example, the frequency response of a device or the frequency spectrum of noise or of a complex electrical signal.

The wide range of paper speed facilitates long-period studies (such as traffic-noise) as well as short-duration-transient measurements (such as auditorium-reverberation). Writing speeds and low-frequency cutoff are selected by a single switch. The frequency response can be extended downward to 4.5 Hz with the slower writing speeds, which filter out abrupt level variations. You get a smoothed plot without loss of accuracy.

The 1521 is a solid-state, single-channel, servo-type recorder with interchangeable logarithmic potentiometers, of 20-, 40-, and 80-dB ranges, and a linear poten-

tiometer for dc recording. The 1521 can be calibrated and relied upon for recording absolute levels as well as changes.

Or in combination This graphic level recorder can be mechanically or electrically coupled to various GR analyzers and oscillators to synchronize the frequency scale of the chart paper with the instrument's calibrated tuning-control dial. With a sound-level meter, the recorder can plot sound levels over a wide dynamic range as a function of time; the writing speed is sufficiently high for the measurement of reverberation time and other transient phenomena.

Combinations are available already assembled; some examples appear in this catalog; inquiries are invited. Of particular importance are recording instrument combinations that meet the requirements of MIL Standard 740B.

SPECIFICATIONS

AC Recording: RANGE: 40 dB full-scale with the potentiometer supplied, 20- and 80-dB potentiometers available for ac level recording. LINEARITY: $\pm 1\%$ of full-scale dB value plus a frequency error of 0.5 dB at 100 kHz and 1.5 dB at 200 kHz).

Frequency Response and Writing Speed, for AC Level Recording: High-frequency response ± 2 dB, up to 200 kHz. Low-frequency sine-wave response depends on writing speed, as shown in following table: (With the 80-dB pot, writing speed < 300 dB/s, i.e., 15 in./s.)

Writing Speed (approx), with 0.1-in. overshoot		Low-Frequency Cutoff (< 1 dB down)
20 in./s	508 mm/s	100 Hz
10	254	20 Hz
3	76	7 (3 dB down at 4.5 Hz)
1	25	7 (3 dB down at 4.5 Hz)

Dc Recording: RANGE: 0.8 to 1 V (0.8 to 1.0 mA) full-scale, with zero position adjustable over full scale. RESPONSE: 3 dB down at 8 Hz (pk-pk amplitude $< 25\%$ of full scale). LINEARITY: $\pm 1\%$ of full scale.

Resolution: $\pm 0.25\%$ of full scale.

Input: AC LEVEL RECORDING: Sensitivity is 1 mV (at 0 dB) into 10 k Ω , attenuator has 60-dB range in 10-dB steps, max limit is 100 V rms. DETECTOR RESPONSE: True rms, within 0.25 dB for multiple sine waves, square waves, or noise. Detector operating level is 1 V. DC RECORDING: Sensitivity is 0.8 or 1 V full scale, into 1 k Ω .

External Dc Reference: An external dc reference voltage of 0.5 to 1.5 V can be applied internally to correct for variations of up to 3 to 1 in the signal source of the system under test.

Paper Speeds

HIGH-SPEED MOTOR: Paper speeds of 2.5, 7.5, 25, 75 in./min. Used for high-speed-transient measurements.

MEDIUM-SPEED MOTOR: Paper speeds of 0.5, 1.5, 5, 15 in./min. Used with analyzers and in level-vs-time plots.

LOW-SPEED MOTOR: Paper speeds of 2.5, 7.5, 25, 75 in./h. Used for measurements from 1 hour to > 2 weeks.

Chart Paper: 4-in. recording width on 5-in. paper, 100 feet long. See separate listing of accessories.

Supplied: 40-dB potentiometer, 12 disposable pens with assorted ink colors, 1 roll of 1521-9428 chart paper, power cord, 1560-P95 Adaptor Cable (phone to double plug).

Available: Potentiometers, chart paper, pens, high-, medium-, and low-speed motors, drive and link units.

Power: 105 to 125 or 210 to 250 V, 50 or 60 Hz, 35 W.

Mechanical: Rack-bench cabinet. DIMENSIONS (wxhxd): Bench, 19x9x13.5 in. (483x229x343 mm); rack, 19x8.75x11.25 in. (483x222x286 mm). WEIGHT: 50 lb (23 kg) net, 62 lb (29 kg) shipping.

Description	Catalog Number
Graphic Level Recorder, 40-dB potentiometer, high-speed motor	
1521-B 60-Hz Bench Model	1521-9802
1521-B 60-Hz Rack Model	1521-9812
1521-BQ1 50-Hz Bench Model	1521-9506
1521-BQ1 50-Hz Rack Model	1521-9507
Graphic Level Recorder, 40-dB potentiometer, medium-speed motor	
1521-B 60-Hz Bench Model	1521-9833
1521-B 60-Hz Rack Model	1521-9834
Graphic Level Recorder, 40-dB potentiometer, low-speed motor*	
1521-B 60-Hz Bench Model	1521-9817
1521-B 60-Hz Rack Model	1521-9818

*Other potentiometers and combinations for both 60-Hz and 50-Hz models available; inquiries invited.

Drive and Link Units for Coupling to Generator and Analyzers

1521-P10B Drive Unit

Provides mechanical-drive output from 1521-B to operate any link unit.



1521-9467

1521-P15 Link Unit

For mechanical coupling to 1564 or 1568 analyzers. Fitted with 24-tooth sprocket. Includes chain.

1521-9615

1521-P16 Sprocket Kit, contains 5 sizes of interchangeable sprockets for 1521-P15: 40, 36, 32, 20, and 16 teeth. Provides choice of scale factor in proportion to that with normal 24-tooth sprocket. Includes chain.

Industry Scale Factors

Industry Standard	Scale Factor (dB/decade)	Decade Length (Inches) for 1304 Generator	Sprocket (teeth)	Pot (dB)
Institute of High Fidelity Manufacturers	20	2.0	16	40
Proposed International Standard	25	2.5	20	40
Electronic Industries Association	30	3.0*	24	40
Institute of High Fidelity Manufacturers	20	4.0	32	20
Hearing Aid Industry	45	4.5	36	40
Proposed International Standard	50	5.0	40	40
Proposed International Standard	50	5.0**	16	40

* Chart paper available for 1304-B Beat-Frequency Audio Generator.

** Decade length applies to 1564-A Sound and Vibration Analyzer; chart paper available.

1521-9616

1900-P1 Link Unit

For coupling to 1900-A Wave Analyzer. Use with chart paper 1521-9464 for scale of 10 kHz per 20 in. and with 1521-9465 for scale of 50 kHz per 10 in. Chain included.

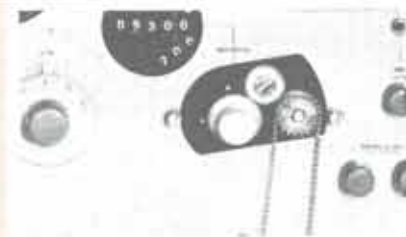

1900-9601

1900-P3 Link Unit

For coupling to 1900-A Wave Analyzer. Use with chart paper 1521-9464 for scale factors of 10 kHz per 20 in. or expanded 1 kHz per 20 in.

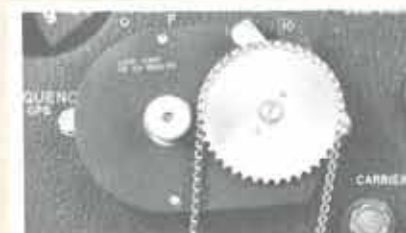

1900-9603

Graphic Level Recorder Accessories (cont'd)

Chart Papers

Dimensions: 5 in. wide x 100 ft long; recording width, 4 in. (127 mm x 30.5 m; 102 mm).

Associated Instrument	Calibration		Chart Length (in.)		Catalog Number
	Horizontal	Vertical (Div)	Cal.	Blank	
1304-B Generator	20 Hz to 20 kHz, log	80	8%	7½	1521-9470*
1350-A Generator-Recorder Assembly	20 Hz to 20 kHz, log	80	8%	7½	1521-9470*
1900-A Analyzer with 1900-P1 or 1900-P3 Link Units	0-1 or 0-10 kHz, linear	40	20	0	1521-9464
1900-A Analyzer with 1900-P1 Link Unit	0-30 kHz, linear	40	16	0	1521-9465
1564-A Analyzer with 1521-P15 Link Unit and 24-tooth sprocket	2.5-25 normalized, log	40	7½	1½	1521-9493
1564-A Analyzer with 1521-P15 Link Unit and 16-tooth sprocket (or with 1564-P1 Dial Drive continuous mode)	2.5-25 normalized, log	40	5	1	1521-9469
1564-A Analyzer with 1564-P1 Dial Drive (stepped mode)	Third-octave bands 3.15 Hz-25 kHz	40	10	0	1521-9460
1568-A Analyzer with 1521-P15 Link Unit	2-20 normalized, log	40	10	2	1521-9475
General use	Continuous ¼-in. div.	40	Continuous	⊕	1521-9428

* Use with 40-dB potentiometer; has 50-dB per decade scale factor required by many testing standards, particularly the ANSI S3.8-1967, "Method of Expressing Hearing Aid Performance."

Potentiometers



1521-P1 20-dB Potentiometer	⊕	1521-9601
1521-P2 40-dB Potentiometer**	⊕	1521-9602
1521-P3 80-dB Potentiometer	⊕	1521-9603
1521-P4 Linear Potentiometer (for dc)	⊕	1521-9604

** Normally supplied with the recorder.

Optional Motors †

		Chart Speeds	
High-Speed Motors Used for high-speed-transient measurements and with 1304 Beat-Frequency Audio Generator. Not for use with 1900-A, 1564-A, and 1568 analyzers.	1521-P19 (for 60-Hz supply) normally supplied in recorder†	2.5-75 in./min	1521-9619
	1521-P21B (for 50-Hz supply)	2.5-75 in./min	1521-9921
Medium-Speed Motors Used with analyzers and in level-vs-time plots; must be used with 1564-P1 Dial Drive.	1521-P23 (for 60-Hz supply)	0.5-15 in./min	1521-9623
	1521-P24 (for 50-Hz supply)	0.5-15 in./min	1521-9624
Low-Speed Motors Used for level-vs-time measurements 1-24 hours.	1521-P20B (for 60-Hz supply)	2.5-75 in./h	1521-9513
	1521-P22B (for 50-Hz supply)	2.5-75 in./h	1521-9514

† Recorder can be supplied with low- or medium-speed motor installed, at same price as with standard motor.

fastrak® Pen Sets and Conversion Kit

The pen used in the 1521-B recorder combines ink reservoir and writing point in a single disposable unit, eliminates refilling. Each cartridge has about twice the life of one old-style pen refill and can outlast three rolls of chart paper. The pen consists of a sealed plastic cartridge with a fiber plastic point that requires only about 2 grams of force to operate properly.

The pens are available with red, green, and blue ink and are supplied in sets of twelve pens. A set of assorted colors is included with the recorder and with the conversion kit.

For converting older 1521-A and 1521-B recorders to use the improved pen, a kit is available that contains a pen holder, set of 12 assorted-color pens, and conversion instructions.



fastrak® Marker Set, Red	⊕	1521-9446
fastrak® Marker Set, Green		1521-9447
fastrak® Marker Set, Blue		1521-9448
fastrak® Marker Set, Assorted Colors		1521-9449
fastrak® Recorder Marker Conversion Kit		1521-9439

⊕ Federal stock numbers are listed before the Index.

1523 Graphic Level Recorder

An excellent recorder PLUS self-contained sweep oscillator for response measurements and 1/3-octave-band analyzer for noise and vibration studies

- 0-Hz to 80-kHz frequency range
- 100- μ V sensitivity
- 20 to 100- μ B dynamic range
- 60 to 1-dB linearity
- 1 response in one with plug-in assembly
- remotely programmable — 2 systems featured

**New Since
Catalog U**



Automatic measurements— simply and graphically The 1523 is *not* just another recorder; it is a measurement center. It incorporates the latest refinements of the recorder field with those of the sweep-oscillator and sound-analyzer fields and does so in one instrument that eliminates the usual bother of trying to keep everything synchronized. Simply connect your signal or device, set up the desired measurement conditions, and push a button — the 1523 does the rest, automatically and without constant attention or control manipulation.

Precise 1/3-octave-band analysis for

- product-noise reduction
- plant- and field-noise studies
- materials testing

Insert the 1523-P3 Stepped 1/3-Octave-Band Analyzer plug-in and your recorder becomes a 1/3-octave-band analyzer with a frequency range of 1 Hz to 80 kHz (ANSI standard bands 0 through 49.) You can perform analysis on selected portions within the full range, and you can switch in an all-pass channel to display the over-all level

at the start of a record. You can also select any one of 11 automatic programs to provide recordings with constant averaging times or, as a unique feature, to provide analyses with statistical confidences of up to 90% to within ± 0.5 dB. You can record measurements singly on a new chart, successively on a single chart for comparison, or successively on new charts, simply by the turn of a single knob.

Simple response measurements for

- filter and network response testing
- loudspeaker, amplifier, and tape-recorder evaluation
- performance tests for microphones, hydrophones, and hearing aids
- general medical and educational applications

With the 1523-P2 Sweep Oscillator plug-in, which incorporates a sweep oscillator, your recorder produces frequency-response recordings at the push of a button. You can set the oscillator to sweep the full 1-Hz to 500-kHz range, or various portions of it, at output levels continuously adjustable from 500 μ V to 5 V behind 600 Ω . A unique and versatile constant-Q mode of operation can be selected to speed the recording in many applications by increasing the sweep rate automatically as the frequency increases. Under many conditions, recordings can be made in the constant-Q mode in $\frac{1}{2}$ to $\frac{1}{3}$ the time normally required.

The accuracy and stability of the generator, plus the resolution of the recorder and the variety of chart speeds and averaging-time programs, permit precise response measurements of almost any device—performed with the ease and economy of a single instrument rather than with the clutter and confusion of two.

Versatile level recording for

- reverberation-time measurements
- general level-recording applications

Select the 1523-P1 Preampifier plug-in for the best in general recorder performance. The 1523-P1 gives you a broad frequency coverage from 1 Hz to 500 kHz, a sensitivity of 100 μ V, and 18 chart speeds from as slow as 20 hours per inch to as fast as half a second per inch. Continuously adjustable attenuation from 0 to 70 dB provides the utmost in recording resolution, and a choice of nine averaging times from 10 ms to 5 s allows supreme flexibility.

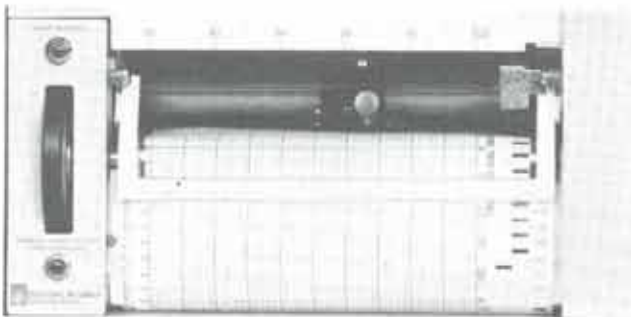

Conveniences standard All plug-ins feature remote programmability, a variety of inputs and outputs to synchronize recorder operation with that of other instruments, and a choice of several potentiometers with dynamic ranges from 10 dB to 100 dB to tailor the instrument to your specific requirement.

For convenience, a chart take-up reel is included but the paper also can be fed out directly for immediate in-

spection and use. For interpretation, an event marker can be recorded by the simple push of a button at the desired time. For reliability, a stepper motor drives the chart (there are no gears or clutches to wear out, slip, or jam), and clog-free disposable pens eliminate messy refilling and provide clear, easily read, and skip-free traces even at the fastest writing speeds. You have a choice of colors and a choice of marker types: the fastrak® Marker for general purposes and the Slow-Speed Marker for particularly slow-moving records or those with much retracing over a part of the chart. GO/NO-GO limit adjustments are included to provide LO, GO, and HI electrical outputs for external alarm or control applications.

SPECIFICATIONS

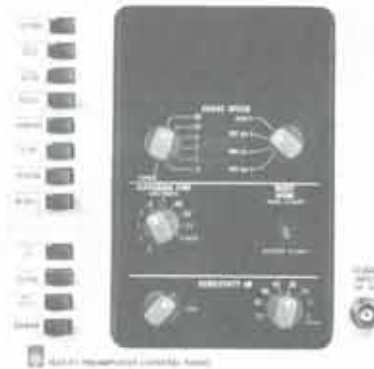

with 1523-P1 Preampifier Plug-in

for level-vs-time recordings

- frequencies to 500 kHz
- 100- μ V sensitivity
- up to 100-dB dynamic range
- 1-M Ω input impedance
- 18 chart speeds

Input: Chart 0-level can be 0 dB (100 μ V) to 70 dB; set in 10-dB steps plus a continuous vernier. See Maximum Input Sensitivity under 1523 Mainframe Specifications. **MAXIMUM INPUT:** ± 10 V pk ac to 250 kHz; ± 5 V pk ac to 500 kHz, re dc component of ± 350 V max. **IMPEDANCE:** 1 M Ω / \approx 30 pF at plug-in; 3.35 k Ω \pm 1% direct to potentiometer via internal switch. **CONNECTORS:** Front and rear BNC and rear 3-pin A3 mike connector that also provides power for 1560-P40 or -P42 Preampifier.

Input Frequency: 1 Hz to 500 kHz; flat within ± 0.1 dB to 100 kHz, within ± 2 dB to 500 kHz except 0-dB range down < 3 dB at 100 kHz. Low-frequency and crest-factor cutoffs depend on averaging times (see below).

Recording: **CHART SPEED:** 0.5 s/in. to 20 h/in., in 18 ranges of 0.5, 1, 2, 5, 10, and 20 h, min, or s/in., plus fast scan of 2 in./s and slow scan of 2 in./min.; all synchronized to line frequency. **AVERAGING TIMES:** 10 ms to 5 s in 9 ranges, all remotely programmable. Sinusoidal low-frequency cutoff (< 1 dB down) and fundamental cutoff for 20-dB crest factor depend on averaging times as follows:

Avg Time	Low-Frequency Cutoff		Avg Time	Low-Frequency Cutoff	
	Sinusoidal	Full Crest Factor		Sinusoidal	Full Crest Factor
10 ms	400 Hz	1 kHz	500 ms	2 Hz	8 Hz
20 ms	100 Hz	500 Hz	1 s	1 Hz	3.5 Hz
50 ms	20 Hz	120 Hz	2 s	< 1 Hz	1.6 Hz
100 ms	10 Hz	35 Hz	5 s	< 1 Hz	1 Hz
200 ms	5 Hz	16 Hz			



with 1523-P2 Sweep Oscillator Plug-in

contains sweep generator for level-vs-frequency recordings

- frequencies to 500 kHz
- 100- μ V sensitivity
- up to 100-dB dynamic range
- 1-M Ω input impedance

Input: Chart 0-level can be 0 dB (100 μ V) to 70 dB; set in 10-dB steps. See also Maximum Input Sensitivity under 1523 Mainframe Specifications. **MAXIMUM INPUT:** \pm 10 V pk ac to 100 kHz, re dc component of \pm 40 V max. **IMPEDANCE:** 1 M Ω /30 pF at plug-in; 3.35 k Ω \pm 1% direct to potentiometer via internal switch. **CONNECTORS:** Front and rear BNC and rear 3-pin A3 mike connector that also provides power for 1560-P40 or -P42 Preamplifier.

Input Frequency: 1 Hz to 500 kHz; flat within \pm 0.1 dB to 100 kHz, within \pm 2 dB to 500 kHz, except on 0-dB range, down $<$ 3 dB at 100 kHz. Averaging times programmed automatically to avoid low-frequency cutoff; program can be inhibited by external input.

Recording: **CHART SPEED:** Automatically set by sweep time (see below) and decade length. Decade length can be set for 2, 2.5, 3, 4, 5, or 10 in./decade.

Sweep Frequency: 1 Hz to 500 kHz; automatically from lower to upper frequency. Lower frequency can be set to 1, 2, 5, 10, 20, 50, 100, or 200 Hz, 1, 10, or 100 kHz; upper frequency can be set to 10 or 100 Hz, 1, 2, 5, 10, 50, 100, 200, or 500 kHz. **ACCURACY:** \pm 1% of indicated frequency. **STABILITY:** \pm 0.05% over 10 min, \pm 0.25% over 24 h; after 30-min warm-up. **SWEEP TIME:** 5 s to 200 ks/decade in 5, 10, 20 sequence; or manual sweep. Averaging time decreases with frequency as follows: 2 s from 1 to 10 Hz, 200 ms from 10 to 100 Hz, 50 ms from 100 Hz to 100 kHz, and 20 ms from 100 to 500 kHz. **SWEEP RESOLUTION:** 3000 discrete logarithmically scaled steps per decade (0.08% step). **SWEEP VOLTAGE:** Dc output proportional to log of swept frequency available at rear connector.

Sweep Amplitude: 500 μ V to 5 V rms into open circuit behind 600 Ω . $>$ 10 mW into 600 Ω , available at front BNC connector; set in four decade ranges of 5 mV to 5 V full-scale open-circuit plus continuous vernier; flat within \pm 0.1 dB to 100 kHz, within \pm 1 dB to 500 kHz. **DISTORTION:** $<$ 0.2% from 1 Hz to 100 kHz with any linear load. **HUM:** $<$ 0.03%. **SPURIOUS** (discrete non-harmonic): -55 dB. **NOISE:** $>$ 60 dB below carrier in 100-kHz bandwidth.



with 1523-P3 Stepped 1/3-Octave-Band Analyzer Plug-in

contains 1/3-octave-band filters for spectrum recording

- 1 Hz to 80 kHz
- Fifty 1/3-octave bands
- 100- μ V sensitivity
- 1-M Ω input impedance
- averaging times varied automatically for fast constant-confidence results

Input: Chart 0-level can be 0 dB (100 μ V) to 70 dB; set in 10-dB steps plus a continuous vernier. **MAXIMUM INPUT:** \pm 10 V pk ac to 100 kHz, re dc component of \pm 90 V max. **IMPEDANCE:** 1 M Ω /30 pF at plug-in, 3.35 k Ω \pm 1% direct to potentiometer via internal switch. **CONNECTORS:** Front and rear BNC and rear 3-pin A3 mike connector that also provides power for 1560-P40 or -P42 Preamplifier.

Input Frequency: 1 Hz to 80 kHz center frequencies; fifty 1/3-octave noise-bandwidth (bands 0 thru 49) 4-pole Butterworth filters with Class II (moderate attenuation) Type O characteristics that conform to ANSI S1.11-1966 for sound-level recordings, switch-selected flat-response (all pass) channel at start of chart displays over-all level. Also available, with filter characteristics conforming to IEC 225, as Type 1523-P3I. **CENTER-FREQUENCY ACCURACY:** \pm 3%. **LEVEL UNIFORMITY:** \pm 1 dB at center frequencies. **PASSBAND RIPPLE:** 1 dB pk-pk max. **NOISE:** Equivalent input noise below 0 dB (re 100 μ V) for all pass, and bands 0-39, increasing 1 dB/band to below 10 dB in band 49. **HARMONIC DISTORTION:** $<$ 0.1% for signals of 1 V rms at band centers. **STOP-BAND ATTENUATION:** $>$ 60 dB for frequencies of $>$ 8 and $<$ 1/8 times center frequency. **OUTPUT:** Filtered input signal available at rear connector. **PEAK MONITOR** included with panel lamp to indicate overload.

Input-Frequency Scan: Adjustable; automatically steps from lower frequency to (but not thru) upper frequency. Lower center frequency can be set to 1, 2, 10, 20, 100, or 1000 Hz; upper center frequency can be set to 0.1, 1, 2, 10, 20, or 100 kHz.

Analysis Programs: **NO. OF PROGRAMS:** 11, designated A, B, C . . . L. **VARIETY:** Program A provides constant averaging time per band; others, combinations of the same with a series of steps of constant confidence (averaging time \propto proportional to one over analysis bandwidth). **CONFIDENCE:** For random noise, for 90% confidence, averaging time is adequate for \pm 0.5-dB accuracy along the "staircase" labeled \pm 0.5 dB. See chart. Similarly, \pm 1.5 dB, for the staircase so labeled. Any part of a program above a staircase has greater confidence. No program operates below the "sine" staircase on the left; thus averaging time is always sufficient to keep the detector operating above its low-frequency cutoff. **AVERAGING TIME:** 5 s for 1-, 1.25-, and 1.6-Hz bands; 5, 2, 1 . . . 0.05 s for higher-freq bands, depending on selected program. **Examples:** (See chart). Program B uses 5-s avg'g time below 2 Hz, 2-s for 2 Hz and above. Program H uses 5-s avg'g time up to

8 Hz, constant confidence (± 1.5 dB) from 8 through 100 Hz, and 0.5-s avg'g time from 100 Hz through 100 kHz. Location of program letter on chart indicates shortest avg'g time for the program. (Imagine that each arrow, like K, extends to right.) SEQUENCE: Analyzer steps to a band, dwells for stabilization, then records the level, at 2 in./s chart speed. DWELL PERIOD: 6 x "averaging time," except at your selected Start Frequency band of each analysis (and "all-pass") 18 x avg'g time.

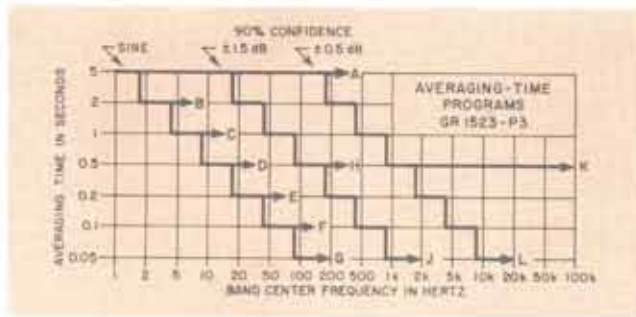

MAINFRAME SPECIFICATIONS

Dynamic Range: Up to 100 dB, depending on potentiometer. **POTENTIOMETERS:** 5 available, all easily interchanged and all with 5-in. scales except for 60 dB which has 12-cm scale, 10 dB (with ± 0.1 -dB linearity); 25 dB (± 0.15 dB), 50 dB (± 0.25 dB), recommended for general use; 60 dB (± 0.3 dB), for use with 1523-P3 only; and 100 dB (± 0.5 dB). **MAXIMUM INPUT SENSITIVITY:** 100 μ V rms for averaging times 0.1 s or greater, 1 mV rms for averaging times < 0.1 s; except for 10-dB pot, max sensitivity 1 mV; minimum averaging time 50 ms. **DEAD BAND:** $\pm 0.15\%$ of full scale; except $\pm 0.25\%$ with 0.01, 0.02 and 0.05 s averaging times. **DETECTION:** True rms, error ≤ 0.1 dB for 15-dB crest factor, < 0.5 dB for full 20-dB crest factor for frequencies above crest-factor cutoff frequency. **NOISE:** Equivalent input noise < 40 μ V rms. **RE-TRANSMITTING POTENTIOMETER:** Provides dc output voltage, proportional to ac input, of 0 to 10.4 V dc (2 V/in. of pen deflection).

Pen Control: Pushbutton switches or external DTL or TTL signals control pen position (up, down, or automatically positioned). Pen status is also indicated by DTL outputs.

Chart Control: Pushbutton switches or external DTL or TTL ground closures start or stop recording, reset paper to start of same chart or advance it to start of next chart, and provide fast forward or reverse. Switch settings are also indicated by DTL outputs. **CHART SPEED** (see Chart Speed under individual plug-in headings): Can be externally programmed except with 1523-P3. **MOTOR:** Stepper motor moves paper in 0.0067-in. increments (0.17 mm) at rates up to 300 increments per second (2 in./s). Pulses supplied by internal clock or by external DTL or TTL input at rates of ≤ 300 pps. Pulses also available as an output to synchronize other recorders. There is exactly one increment for each pulse. **PHOTOCELL:** DTL ground-closure output corresponds to black marks printed on paper.

Limits and Event Markers: LIMITS: 3 DTL outputs provide HI, GO, and LO continuous indications of the recording level vs 2 adjustable limits. **EVENT MARKERS:** 2 pens; pushbutton switch controls one pen to mark selected events on paper;



external DTL or TTL signal activates either or both pens. (These markers act more like "rubber stamps" than "pens.")

Interface: All plug-in pushbutton-control functions can be remotely indicated or controlled; other controls cannot be except for Chart Speed and Averaging Time controls on -P1 and -P2 and Sweep Time Per Decade on -P2. Levels are standard DTL or TTL, i.e., "low" is closure to ground or 0 to +0.5 V; "high" is +3.5 to +5.0 V. Logic-circuit input and output connections are available at 2 double 19-pin etched-board terminals, at rear of main frame, when plug-in is installed.

Supplied: 3-ft BNC-terminated patch cord, 3 rolls of chart paper, fastrak® Marker Set (4 red, 4 green, 4 blue pens), Event Marker Set of 4 red and 4 black pens, 3 potentiometer contacts, 2 paper cap assemblies, 50 chart-mounting sheets, power cord; double 19-pin etched-board connectors (1 or 2) for external programming (inputs and outputs) with each plug-in.

Power: 100 to 125 or 200 to 250 V, 50 to 60 Hz; 90 W typical, 160 W max.

Mechanical: Bench or rack models. **DIMENSIONS** (wxhxd): Bench 19.56x8.44x19.63 in. (496x214x498 mm); rack, 19x7x19.69 in. (483x178x500 mm). **WEIGHT:** Bench, including plug-in, 63 lb (29 kg) net, 98 lb (45 kg) shipping; rack, including plug-in, 57 lb (26 kg) net, 92 lb (42 kg) shipping; plug-in when shipped separately, 8 lb (3.7 kg) net, 16 lb (8 kg) shipping.

Description	Catalog Number
1523 Graphic Level Recorder, main frame without plug-in	
Bench Model	1523-9700
Rack Model	1523-9701
Select at least 1 of following plug-ins (which are easily interchanged, to suit various applications):	
Preamplifier Plug-in, 1523-P1	1523-9601
Sweep Oscillator Plug-in, 1523-P2	1523-9602
Stepped 1/3-Octave-Band Analyzer Plug-in, Conforms to ANSI S1.11-1966, 1523-P3	1523-9603
Stepped 1/3-Octave-Band Analyzer Plug-in, conforms to IEC 225, 1523-P3i	1523-9605
Select at least 1 of following potentiometers (which are easily interchanged, to suit various requirements):	
10-dB Potentiometer	1523-9620
25-dB Potentiometer	1523-9621
50-dB Potentiometer (normally supplied if no other is ordered)	1523-9622
60-dB Potentiometer, used only with 1523-P3	1523-9623
100-dB Potentiometer	1523-9624
Accessories available	
Event-Marker Sets, 4 black and 4 red pens	1522-9612
Mounting Sheets, 8½ x 11 in. sheets with adhesive strips to mount charts for filing in 3-ring notebooks, 50 sheets per pack	1522-9639
fastrak® Marker Sets (general purpose)	
Set of 4 RED pens	1522-9614
Set of 4 GREEN pens	1522-9615
Set of 4 BLUE pens	1522-9616
Slow-Speed Marker Sets	
Set of 4 RED pens	1522-9634
Set of 4 GREEN pens	1522-9635
Set of 4 BLUE pens	1522-9636
Extender-Board Kit, used for maintenance	1523-9630
Chart Paper, 140-ft rolls of 6.63-in. wide paper with 5-in. vertical chart area of 50 div (except 1523-9644* and -9646* which have 12-cm vertical chart area of 50 div); include timing marks for proper synchronization.	
FOR 1523-P1 PREAMPLIFIER: Linear, continuous scale of 0.2 in. per div.	1523-9641
FOR 1523-P2 SWEEP OSCILLATOR:	
2 10-in. decades, starts at 1, ends at 100	1523-9645
3 5-in. decades, starts at 1, ends at 1 k	1523-9649
3½ 2.5-in. decades, starts at 1, ends at 2 k	1523-9648
3½ 3-in. decades, starts at 10, ends at 20 k	1523-9650
5½ 2.5-in. decades, starts at 1, ends at 500 k	1523-9642
FOR 1523-P3 STEPPED 1/3-OCTAVE-BAND ANALYZER:	
3½ 2.5-in. decades, starts at 1, ends at 2 k	1523-9640
*3½ 5-cm decades, starts at 1, ends at 2 k	1523-9646
5 2.5-in. decades, starts at 1, ends at 100 k	1523-9647
*5 5-cm decades, starts at 1, ends at 100 k	1523-9644

* For use only with 60-dB potentiometer.

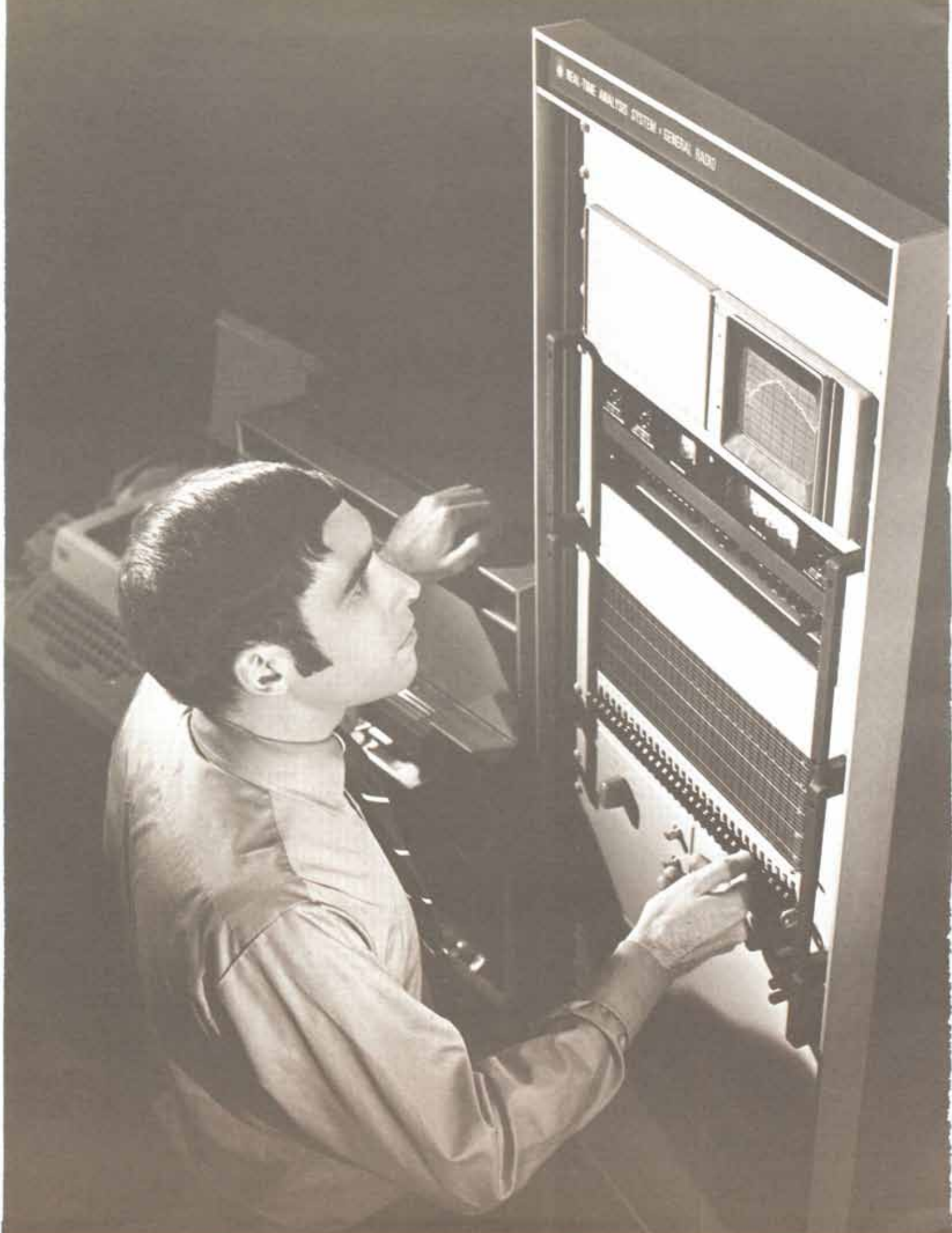

REAL-TIME ANALYSIS SYSTEM - GENERAL RADIO

1564-A Sound and Vibration Analyzer

- 2.5 Hz to 25 kHz
- 2 bandwidths: 1/3- and 1/10-octave
- use direct from microphone or vibration pickup
- ac or portable battery operation
- automatic spectrum plots with 1521 recorder

The 1564-A Sound and Vibration Analyzer is designed primarily for measuring the amplitude and frequency of the components of complex sound and vibration spectra. Its 1/3-octave (23%) and 1/10-octave (7%) noise bandwidths provide the flexibility needed for analysis of both the noise and its causes.

Input sources The high input impedance of the analyzer permits direct connection of piezoelectric transducers for measuring sound pressures from 44 to 150 dB re $20\mu\text{N}/\text{m}^2$ and acceleration from 0.0007 g to 100 g.

The 1560-P42 and 1560-P40 Preamplifiers are available to extend the full scale sensitivity of the analyzer by 20 dB (10:1) and to allow use of the transducer at the end of a long extension cable. Alternatively, for higher sensitivity, the analyzer can be driven from a sound-level meter or vibration meter.

Automatic analysis Automatic range switching is provided so that the 1521-B Graphic Level Recorder can record automatically the spectrum of a signal under analysis. The combination of analyzer and recorder is available as the 1911-A Recording Sound and Vibration Analyzer for continuous spectrum plots. This combination is particularly well suited to measurements in accordance with MIL Standard 740B.

Noise filter The analyzer can be used in conjunction with the 1390-B, 1381, or 1382 random-noise generators for transfer and reverberation measurements using 1/3- or 1/10-octave bands of random noise.

Description The 1564-A consists of a high impedance amplifier, a continuously tunable filter having a noise bandwidth of either 1/3 or 1/10 octave, an output amplifier, and a meter. The center frequency of the filter is continuously adjustable. An all-pass, or flat, characteristic permits measurement of the over-all signal amplitude.

SPECIFICATIONS

Frequency: RANGE: 2.5 Hz to 25 kHz in four decade ranges. **DIAL CALIBRATION:** Logarithmic. **ACCURACY OF CALIBRATION:** $\pm 2\%$ of frequency-dial setting.

Filter Characteristics: Noise bandwidth is either 1/3 octave or 1/10 octave. One-third-octave characteristic has at least



30-dB attenuation at one-half and twice the selected frequency. One-tenth-octave characteristic has at least 40-dB attenuation at one-half and twice the selected frequency. Ultimate attenuation is 70 dB or greater for both characteristics. For both bandwidths, peak response is uniform ± 1 dB from 5 Hz to 10 kHz and ± 1.5 dB from 2.5 Hz to 25 kHz. An all-pass, or flat, characteristic is also included.

Detector Characteristics: Rms with three averaging times. Faster two speeds conform with ANSI standard for sound-level meters.

Input: IMPEDANCE: 25 M Ω in parallel with 80 pF (independent of attenuator setting). **VOLTAGE RANGE:** 0.3 mV to 30 V full scale in 10-dB steps. **MICROPHONE:** 1560-P6 Microphone Assembly or the 1560-P42 or 1560-P40 Preamplifiers are recommended.

Output: **VOLTAGE:** At least 1.0 V open circuit, when meter reads full scale. **IMPEDANCE:** 6000 Ω . Any load can be connected. **METER:** Three scales, 0 to 3 V; 0 to 10 V; -6 to +10 dB.

Recording Analyzer: Automatic range switching at the end of each frequency decade allows convenient continuous recording of spectra with the 1521-B Graphic Level Recorder.

Calibration: Built-in, feedback-type calibration system permits amplitude calibration at any frequency.

Available: 1560-P6 MICROPHONE ASSEMBLY, 1560-P52, -P53, -P54 VIBRATION PICKUPS, 1560-P40 and -P42 PREAMPLIFIERS (power for preamp available at input connector).

Power: Operates from 105 to 125 or 210 to 230 V, 50-60 Hz, or from nickel-cadmium battery supplied. Battery provides 25 h of operation when fully charged and requires 14 h for charging.

Mechanical: Flip-Tilt case and rack mount. **DIMENSIONS (wxhxd):** Portable, 10.25x8.13x8 in. (260x206x203 mm); rack, 19x10.5x6 in. (482x267x152 mm). **WEIGHT:** Portable, 15 lb (7 kg) net, 17 lb (8 kg) shipping; rack, 16 lb (8 kg) net, 28 lb (13 kg) shipping.

Description	Catalog Number
1564-A Sound and Vibration Analyzer	
Portable Model, 115 V \pm	1564-9701
Rack Model, 115 V	1564-9820
Portable Model, 230 V	1564-9702
Rack Model, 230 V	1564-9821
Replacement Battery	8410-0410
Patent Number 3,012,197.	

Ⓢ Federal stock numbers are listed before the index.



1568-A Wave Analyzer

- 20 Hz to 20 kHz
- 1% constant-percentage bandwidth
- portable, battery-operated
- 85-dB rejection

The 1568-A is an important instrument for high-resolution frequency analyses, whether for measuring vibration and noise components or the spectrum of a complex electrical signal. Good design combines the excellent

filter shape of a wave analyzer with the convenient, simple operation of constant-percentage-bandwidth analyzers in a portable, low-cost instrument.

The voltage sensitivity and input impedance, adequate for most uses, can be improved to 10 microvolts full-scale and > 500 megohms, respectively, by the use of a 1560-P42 or 1560-P40 Preamplifier. Power for the preamplifier is supplied at the input connector.

High resolution Narrow bandwidth permits separation of closely spaced frequencies; wide dynamic range, high stop-band attenuation, and low distortion allow measure-

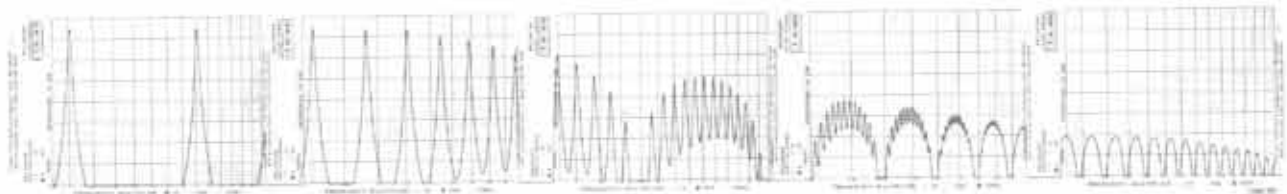

Frequency spectrum analysis of a 1.0-ms pulse at a 70-Hz repetition rate. The 1% bandwidth yields high resolution at low frequencies, shows the envelope at high frequencies.

ment of small components in the presence of components up to 80 dB larger. These capabilities are vital to the identification of unwanted vibration and noise components and to the measuring of discrete frequencies in complex electrical waveforms. At low frequencies, bandwidth is narrower, stability better, and calibration more accurate than those of fixed-bandwidth heterodyne wave analyzers.

The 1568 excels in such applications as

- harmonic distortion measurements at low frequencies
- harmonic analysis — 1% bw yields 50 components.

SPECIFICATIONS

Frequency: RANGE: 20 Hz to 20 kHz in six half-decade ranges. DIAL CALIBRATION: Logarithmic. ACCURACY OF FREQUENCY CALIBRATION: 1%.

Filter Characteristics: BANDWIDTH between 3-dB points on selectivity curve: 1% of selected frequency. ATTENUATION, at 20% above and at 20% below selected frequency: > 50 dB referred to the level at the selected frequency. Attenuation at twice and at one-half the selected frequency is ≥ 75 dB referred to the level at the selected frequency. Ultimate attenuation is > 85 dB. UNIFORMITY of filter peak response with tuning: ± 1 dB from 20 Hz to 6.3 kHz and ± 2 dB from 20 Hz to 20 kHz.

Input: IMPEDANCE: 100 k Ω . VOLTAGE RANGE: 100 μ V to 300 V, full scale, in 3-10 series steps. DISTORTION: Input-circuit distortion is lower than -80 dB relative to input-signal level. PREAMPLIFIER: Power is supplied at input socket for the accessory preamplifier, which extends the sensitivity to 10 μ V, full scale, and increases the input impedance to more than 500 M Ω .

Output: IMPEDANCE: 6000 Ω . Any load can be connected. VOLTAGE: At least one volt open circuit when meter reads full scale. CREST-FACTOR CAPACITY: Greater than 13 dB.

Output Meter: CALIBRATION: Voltage (see above) and dBm, with reference at 1 mW into 600 Ω (775 mV). DAMPING: 2 modes, Fast and Slow, for manual measurements of noise.

Analyzing Range: 80 dB. Components of an input signal that differ in amplitude by as much as 80 dB can be measured.

Automatic Recording: Automatic range switching is provided to allow convenient, continuous spectrum plotting when the 1521 Graphic Level Recorder is used. Medium-speed motor is recommended. Chart paper is Catalog No. 1521-9475. Frequency scale is logarithmic, 10 inches per decade; vertical scale is 4 inches for 20, 40, or 80 dB, depending on the potentiometer used in the recorder.

Calibrator: A built-in, feedback-type calibration system permits amplitude calibration at any frequency.

Supplied: Power cord; 1568-2090 Detented Knob and Dial Assembly, used to facilitate measuring the components of an input signal as a percentage or in decibels with an arbitrary voltage reference.

- detailed analysis of machinery noise and vibration
- separation of close, discrete, low frequencies

Automatic analysis In combination, the 1568-A and 1521-B Graphic Level Recorder produce spectrum plots with as much as a 70-dB recording range. Automatic range switching is included for ease and speed in making spectrum analyses. The analyzer and recorder are available mounted in a cabinet, interconnected, and mechanically coupled as a complete system, the 1913 Recording Wave Analyzer.

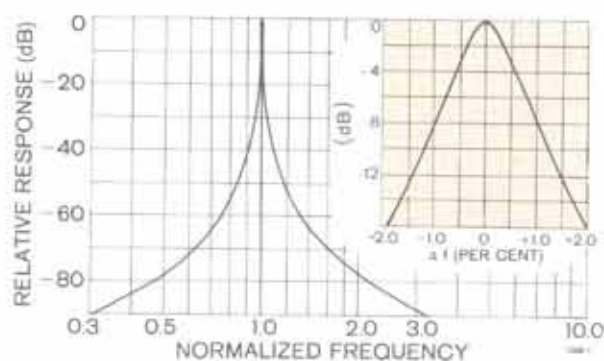

Attenuation characteristics of the filter.

Available: PREAMPLIFIER 1560-P42 or 1560-P40; Link Unit 1521-P15, with Sprocket Kit 1521-P16 for mechanical coupling to 1521-B Graphic Level Recorder equipped with Drive Unit 1521-P10B; Chart Paper 1521-9475.

Power: 100 to 125 or 200 to 250 V, 50 to 60 Hz. 2 W for normal operation, 3.5 W for battery charging. A rechargeable nickel-cadmium battery is supplied. Battery provides about 20 hours of operation when fully charged and requires 16 hours for charging. Internal charger operates from the power line.

Mechanical: Flip-Tilt case and rack mount. DIMENSIONS (wxhxd): Portable, 13.25x13x8.25 in. (337x330x210 mm); rack, 19x12.25x5 in. (483x312x127 mm). WEIGHT: 22 lb (10 kg) net, 27 lb (13 kg) shipping.

Description	Catalog Number
1568-A Wave Analyzer	
Portable Model, 115 V ac *	1568-9701
Portable Model, 230 V ac	1568-9702
Rack Model, 115 V ac	1568-9820
Rack Model, 230 V ac	1568-9821
1521-P15 Link Unit	1521-9615
1521-P16 Sprocket Kit	1521-9616
Chart Paper	1521-9475
Replacement Battery	8410-0410

* Federal stock numbers are listed before the index.

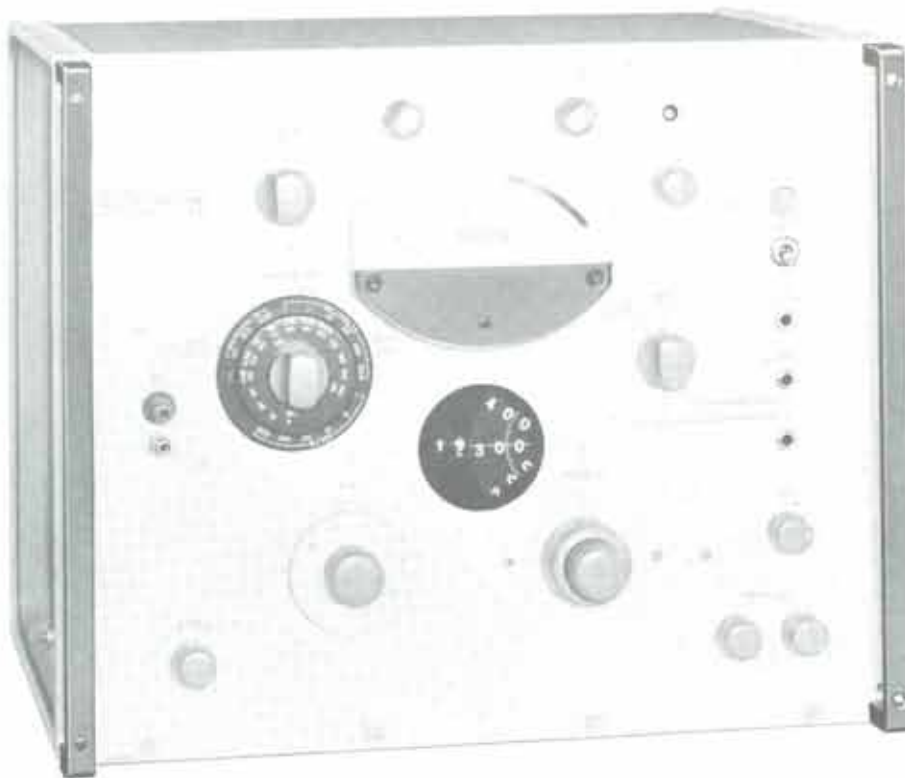

1900-A Wave Analyzer

- 20 to 54,000 Hz, linear frequency scale
- 3-, 10-, and 50-Hz bandwidths
- 30 μ V to 300 V, full scale — 3 μ V with preamp
- 80-dB recording analyzer with 1521 recorder
- outputs: filtered or BFO, 100 kHz and dc recorder
- 1-megohm input impedance on all ranges

The wave analyzer is used for measuring the components of, or analyzing the spectra of, complex electrical signals, acoustic noise, or mechanical vibrations:

Individual components of periodic complex waveforms such as harmonic or intermodulation distortion are readily separated and measured, owing to the excellent selectivity.

Automatic frequency control enables the 1900-A to remain tuned to a slowly varying component that might otherwise drift out of the 50-Hz bandwidth.

This analyzer is particularly suited for analyzing noise, because its bandwidth in hertz is independent of the center frequency. The required averaging time is, therefore, constant, and the calculation of spectrum level is simple. Furthermore, when the 50-Hz bandwidth is used, the required averaging time is reasonably short.

For automatic analysis, outputs are provided for driving the 1521 Graphic Level Recorder as well as dc recorders.

Tunable filter use The analyzer can also be used as a tunable filter, so that the individual components of a complex input signal can be used to drive other instruments, such as frequency counters, when a highly accurate measure of the component frequencies is desired, or to drive earphones. When a wide-band noise generator drives the analyzer, the output is a tunable narrow band of noise. Such a signal is useful in a number of psychological and architectural-acoustics tests.

As a tracking generator In the "tracking generator" mode of operation, a measurement signal is made available that is a sine wave tunable over the 54-kHz range and always in tune with the analyzer. When this signal is used to drive a bridge or other network, an output from that network can be measured by the analyzer, whose selectivity reduces the interference from extraneous noise, hum, and distortion.

Description The 1900-A is a heterodyne type of voltmeter. The intermediate-frequency amplifier at 100 kHz includes a highly selective quartz-crystal filter whose bandwidth can be switched to 3, 10, and 50 Hz. The use of a heterodyne system makes it possible to vary the response frequency although the filter frequency is fixed. The 100-kHz output of the filter is indicated on a meter and is also available at the panel. In one mode of operation the output is also heterodyned back to the original frequency. In another mode, the local oscillator beats with a 100-kHz quartz-crystal oscillator to function as a beat-frequency oscillator. These two outputs are also available at panel terminals as *filtered input component* and *indicated frequency*, respectively.

SPECIFICATIONS

Frequency: RANGE: 20 to 54,000 Hz. The frequency is indicated on a counter and a dial with a linear graduation, 10 Hz per division. ACCURACY OF CALIBRATION: $\pm(1/2\% + 5 \text{ Hz})$ up to 50 kHz; $\pm 1\%$ beyond 50 kHz. INCREMENTAL-FREQUENCY DIAL (ΔF): $\pm 100 \text{ Hz}$. Accuracy is $\pm 2 \text{ Hz}$ below 2 kHz, $\pm 5 \text{ Hz}$ up to 54 kHz. AUTOMATIC FREQUENCY CONTROL: At frequencies below 10 kHz, total range of frequency lock is 400 Hz for the 50-Hz band and 150 Hz for the 10-Hz band, as defined by 3-dB drop in response from full-scale deflection. At 50 kHz, the lock ranges decrease to one-half of these values.

Selectivity: Three bandwidths (3, 10, and 50 Hz). Effective bandwidth for noise is equal to nominal bandwidth within $\pm 10\%$ for 10- and 50-Hz bands and $\pm 20\%$ for 3-Hz band. 3-HERTZ BAND: At least 30 dB down at $\pm 6 \text{ Hz}$ from center frequency, at least 60 dB down at $\pm 15 \text{ Hz}$, at least 80 dB down at $\pm 25 \text{ Hz}$ and beyond. 10-HERTZ BAND: At least 30 dB down at $\pm 20 \text{ Hz}$, at least 60 dB down at $\pm 45 \text{ Hz}$, at least 80 dB down at $\pm 80 \text{ Hz}$ and beyond. 50-HERTZ BAND: At least 30 dB down at $\pm 100 \text{ Hz}$, at least 60 dB down at $\pm 250 \text{ Hz}$, at least 80 dB down at $\pm 500 \text{ Hz}$ and beyond.

Input: IMPEDANCE: 1 M Ω shunted by 30 pF on all ranges. VOLTAGE RANGE: 30 μV to 300 V, full scale, to 3 μV with preamp, in 3, 10 series. A decibel scale is also provided. VOLTAGE ACCURACY: After calibration by internal source, the accuracy up to 50 kHz is $\pm(3\%$ of indicated value + 2% of full scale) except for the effects of internal noise when the attenuator knob is in the maximum-sensitivity position. From 50 to 54 kHz, the above 3% error becomes 6%. RESIDUAL MODULATION PRODUCTS AND HUM: At least 75 dB down.

Outputs: 100-kHz OUTPUT: Amplitude is proportional to amplitude of selected component in analyzer input signal. With the 1521 Graphic Level Recorder connected, full-scale output is at least 3 V. Dynamic range from overload point to internal noise is $>80 \text{ dB}$ with attenuator knob fully clockwise. RECORDING ANALYZER: See the 1910-A Recording Analyzer and 1521-B Graphic Level Recorder. DC OUTPUT: 1 mA in 1500 Ω , full scale, one side grounded. FILTERED INPUT COMPONENT: Output at least 1 V across 600- Ω load for full-scale meter deflection with output control at max. TRACKING ANALYZER (INDICATED FREQUENCY): 20 Hz to 54 kHz; output is at least 2 V across 600- Ω load with output control at max. **Terminals:** Input, binding posts; output, telephone jacks.

Supplied: 1560-P95 Adaptor Cable, phone plug, power cord.

Available: 1900-P1 and 1900-P3 LINK UNITS for coupling to 1521 Graphic Level Recorder, 1560-P40 and 1560-P42 PRE-AMPLIFIERS (use 1560-P62 Power Supply).

Power: 105 to 125 or 210 to 250 V, 50 to 400 Hz, 40 W.

Mechanical: Rack-bench cabinet. DIMENSIONS (wxhxd): Bench, 19x16.25x15.25 in. (483x413x387 mm); rack, 19x15.75x13.25 in. (483x400x337 mm). WEIGHT: 56 lb (26 kg) net, 140 lb (64 kg) shipping.

Description	Catalog Number
1900-A Wave Analyzer	
Bench Model, 115 V	1900-9801
Rack Model, 115 V	1900-9811
Bench Model, 230 V	1900-9802
Rack Model, 230 V	1900-9812

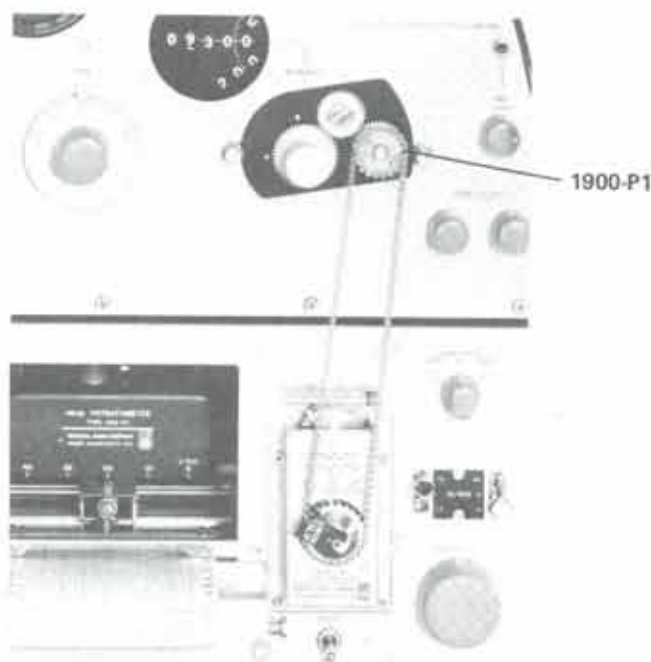

Automatic Wave Analysis

The Analyzer-Recorder Link The 1900-A Wave Analyzer can be used in conjunction with the GR 1521 Graphic Level Recorder to produce, automatically, permanent graphic records of high-resolution spectrum analyses. The necessary coupling mechanisms and chart papers are available for frequency scales of 50, 500, or 5000 Hz per inch. A choice of 3 recorder potentiometers permits selection of 20, 10, or 5 dB per inch, so that virtually any combination of horizontal and vertical scale resolution is possible.

The 1900-P1 or 1900-P3 Link Unit mounts on the wave analyzer in place of the manual frequency-tuning knob and provides mechanical coupling to the recorder. The 1900-P3 permits selection of 500- or 50-Hz/in. scale factors with a lever; the 1900-P1 provides 5000 or 500 Hz/in. by the interchanging of sprocket wheels.

An assembly of the 1900-A Wave Analyzer, 1900-P1, and 1521-B Graphic Level Recorder is available as the 1910-A Recording Wave Analyzer.

Description	Catalog Number
1900-P1 Link Unit	1900-9601
For chart paper, use 1521-9464 (500 Hz/in.) or 1521-9465 (5 kHz/in.)	
1900-P3 Link Unit	1900-9603
For chart paper, use 1521-9464	

Frequency-Response and Spectrum Recorder Assemblies

Several GR instruments can be used with the 1521-B Graphic Level Recorder for automatic plotting of the frequency response of a device or the frequency spectrum of (for example) acoustic noise or of a complex electrical waveform. Automatic plotting with these instruments replaces tedious point-by-point manual methods and provides much more information in the form of finer-resolution curves. Listed below are several such assemblies

that can be ordered under single catalog numbers and include all accessories normally needed. Or the component items can be ordered individually to convert existing equipment into fully automatic recording assemblies.

Custom assemblies of GR analysis equipment and sound and vibration instruments can be built to order to meet a variety of special requirements.

1910-A Recording Wave Analyzer

The 1910-A is particularly useful in analyzing and recording the frequency components present in mechanical vibrations, acoustic signals, and in complex electrical signals including random noise. Its linear frequency scale, 20-Hz to 54-kHz range, three bandwidths (3, 10, and 50 Hz), and 80-dB dynamic range permit higher-order, closely spaced and weak components to be found with ease.

SPECIFICATIONS

The 1910-A assembly includes the following:

1900-A Wave Analyzer, including **1560-P95 Adaptor cable** and other accessories

1521-B (or -BQ1 for 50-Hz supply) **Graphic Level Recorder** with **40-dB Potentiometer** (1521-9602) and medium-speed motor

1521-P3 80-dB Potentiometer (1521-9603)

1521-P10B Drive Unit (1521-9467) (installed)

1900-P1 Link Unit (1900-9601) (installed)

1900-P3 Link Unit (1900-9603)

Chart Paper, 10 rolls (1521-9464), scale 0-10 kHz

Chart Paper, 10 rolls (1521-9465), scale 0-50 kHz

Adaptor Cable, double banana to right-angle phone plug.

Available: 1560-P40 and 1560-P42 Preamplifiers; choice of vibration pickups or microphones.



Mechanical: Assembled in cabinet. **DIMENSIONS** (wxhxd): 19x25.25x15.25 in. (483x642x388 mm). **WEIGHT:** 116 lb (53 kg) net, 227 lb (104 kg) shipping.

Description	Catalog Number
1910-A Recording Wave Analyzer	
60-Hz 115-V Model	1910-9701
60-Hz 230-V Model	1910-9711
50-Hz 115-V Model	1910-9493
50-Hz 230-V Model	1910-9494

1911-A Recording Sound and Vibration Analyzer

This assembly will generate continuous frequency plots of the 1/3- or 1/10-octave spectrum of sound and vibration signals over the range of 4.5 Hz to 25 kHz. Thus 1/3-octave measurements can be made in accordance with several common military and industrial noise-control specifications. While the third-octave bandwidth is convenient for testing compliance to a specification for maxi-

mum allowable noise or vibration level, the 1/10-octave bandwidth permits precise identification of individual frequency components, leading to their reduction or elimination. The analyzer will accept signals from a sound-level meter, vibration meter, or other stable amplifier, or directly from a microphone or vibration pickup. It includes a storage drawer and system power control.

SPECIFICATIONS

The 1911-A consists of the following:

1564-A Sound and Vibration Analyzer, rack model

1521-B (or -BQ1 for 50-Hz supply) **Graphic Level Recorder** with **40-dB Potentiometer** (1521-9602) and medium-speed motor

1521-P10B Drive Unit (1521-9467)

1521-P15 Link Unit (1521-9615), with 16-tooth sprocket installed (standard 24-tooth sprocket also included)

Chart Paper, 10 rolls (1521-9469), calibrated 2.5-25 normalized, logarithmic.

Adaptor Cable, double banana to right-angle phone plug.

Available: 1560-P40K Preamplifier and Microphone Set; 80-dB potentiometer; choice of vibration pickups.

Mechanical: Assembled in cabinet. DIMENSIONS (wxhxd): 19.75x31.25x15.75 in. (502x794x400 mm). WEIGHT: 101 lb (46 kg) net, 158 lb (72 kg) shipping.



Description	Catalog Number
1911-A Recording Sound and Vibration Analyzer	
60-Hz 115-V Model	1911-9701
60-Hz 230-V Model	1911-9711
50-Hz 115-V Model	1911-9493
50-Hz 230-V Model	1911-9494

1913 Recording Wave Analyzer — 1% Bandwidth

This constant-percentage-bandwidth recording analyzer will make high-resolution spectrum plots from 20 Hz to 20 kHz. It is easy to use, having automatic range switching and few controls. Wide dynamic range and the 80-dB potentiometer reduce the need to change sensitivity manually to accommodate widely varying amplitudes. Narrow bandwidth permits separation of closely spaced low frequencies without forfeiting high-frequency resolution; typically, the fiftieth harmonic can be identified. See description of 1568-A Wave Analyzer for more details.

The 1913 is supplied assembled and includes a storage drawer and system power control, which switches the analyzer battery supply as well as the ac line.

SPECIFICATIONS

The 1913 includes the following:

1568-A Wave Analyzer, rack model, and accessories

1521-B (or -BQ1 for 50-Hz supply) **Graphic Level Recorder** with **40-dB Potentiometer** (1521-9602) and medium-speed motor

1521-P3 80-dB Potentiometer (1521-9603)

1521-P10B Drive Unit (1521-9467)

1521-P15 Link Unit (1521-9615), with 16-tooth sprocket installed (standard 24-tooth sprocket also included)

Chart Paper, 10 rolls (1521-9475), scale 2-20 log, normalized

Adaptor Cable, double banana to right-angle phone plug.

Available: 1560-P40 and 1560-P42 Preamplifiers.



Mechanical: Assembled in cabinet. DIMENSIONS (wxhxd): 19.75x31.25x15.75 in. (502x794x400 mm). WEIGHT: 110 lb (50 kg) net, 165 lb (75 kg) shipping.

Description	Catalog Number
1913 Recording Wave Analyzer	
60-Hz 115-V Model	1913-9700
60-Hz 230-V Model	1913-9702
50-Hz 115-V Model	1913-9703
50-Hz 230-V Model	1913-9701

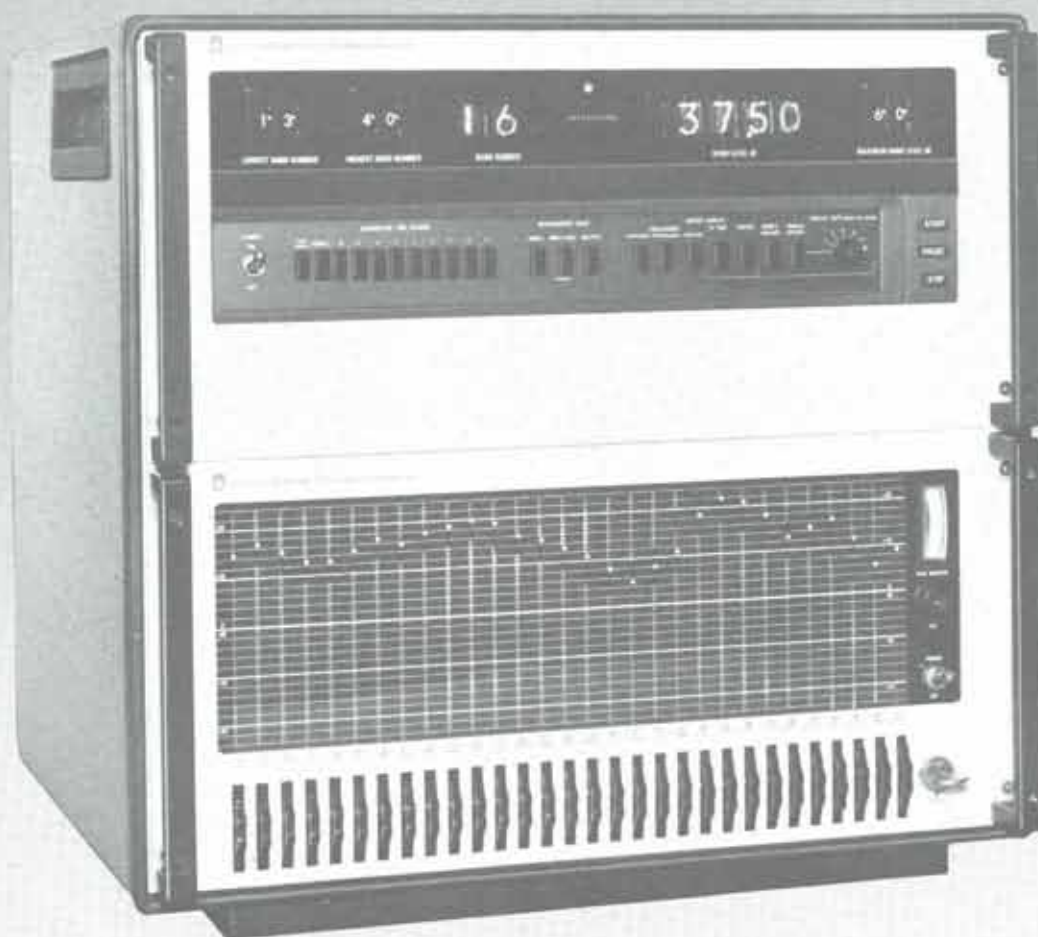

1921 Real-Time Analyzer

- 3.15 Hz to 80 kHz
- 30 to 45 one-, 1/3-, or 1/10-octave bands
- 70-dB dynamic range, 60 dB displayed
- 100-mV sensitivity
- calibrated attenuators
- digital detection → true rms answers
- 9 known integration periods
- corrected spectrum displayed directly

Realization of a long-standing need Since the inception of the first sound and vibration instruments, the need for rapid, on-line measurements was apparent. But it took some thirty years to fulfill the need, adequately and

economically, and the fulfillment came with the introduction of real-time analysis embodied in the 1921.

The 1921 is at least 30 times faster than contemporary serial analyzers, which means it can analyze more data faster and can measure non-stationary signals without tape loops. Its 70-dB dynamic range readily accepts the random or totally unspecified signals routinely encountered in acoustic work. The answers come fast; they are repeatable and statistically reliable because of the analyzer's ± 0.5 -dB accuracy and known integration times.

Optional attenuators provide ± 0.25 -dB accuracy for dynamic-range extension, transducer flattening, subjective correlation, etc., and the filters incorporate A-, B-, or C-weighting networks. The entire capability has been specifically designed to permit simple, rapid, and precise control and interpretation of the measurements with a

minimum of operator attention. Even less work and faster results are possible when auxiliary instrumentation is wedded to the 1921, instrumentation such as computer control, scanner input, dc recorders, or data printers — all of which interface with ease.

A unique solution The input signal is applied to a set of analog filters (from 30 to 45 depending on your requirements) that cover a frequency range from 3.15 Hz to 80 kHz. These filters include, as an option, individual attenuators to permit pre-whitening or other signal conditioning. They are housed in a unit that can be purchased separately if desired.

The outputs of the filters are processed in another unit, the rms detector. It is unique in that it processes the signals from the filters digitally. Each channel is sampled, the sampled data are converted to digital binary form, and the binary numbers are fed to a digital processor that computes root-mean-square levels.

The averaging method is true (linear) integration with a choice of nine accurate integration times from 1/2 second to 32 seconds. This scheme not only produces answers faster than the running-average circuits found in analog devices (which "waste" time and aren't very useful for transient signals) but also make it possible to determine exactly what events in time have affected the answer. The computed band levels are stored in digital memory to be retrieved at a rate limited only by the output recording or storage device. The analyzer simultaneously provides both digital and analog outputs.

Versatility The 1921 is available in bench or rack models, in four standard frequency ranges, and with or without attenuators. Custom versions with up to 45 bands, either 1/10, 1/3, 1 octave wide, or a mixture of the three, are available on special order, as are models with special bandwidths.

Complete systems, tailored to your needs from transducer to final data storage, can also be supplied. Such a system could include a computer, display scope, dc recorder, and magnetic tape recorder to provide on-line calculations and comparisons such as:

- Spectrum comparisons from 3.15 Hz to 80 kHz
- Stevens loudness calculations per ANSI S3.4-1968
- ARF loudness calculations
- Perceived-noise-level (PNL) computations recommended by the FAA
- Speech-interference-level (SIL) computations
- Noise criterion levels per L. L. Beranek
- ARI, AMCA, ASHRAE, and STC ratings

— See **GR Experimenter** for May-June 1969 and reprint E122.

SPECIFICATIONS

Frequency: 3.15 Hz to 80 kHz.

Bandwidth: 1/3 octave standard; 1/10 and 1 octave available.

Amplitude: 70-dB dynamic range, 60 dB displayed; 100-mV rms nominal full-scale sensitivity.

Linearity: ± 0.5 -dB deviation from best straight-line fit over top 50 dB of display range, ± 1 dB over entire 60-dB range.

Digital Presentation: Band information is displayed on high-intensity neon-readout tubes. BAND NUMBER per ANSI S1.6 and S1.11 is displayed on 2 tubes and available as 2 BCD digits on rear panel. BAND LEVEL from 0 to 159 dB in 0.25-dB steps is displayed on 5 tubes and available as 5 BCD digits on rear panel with overload indicated as 8 or 9 in left digit. REAR-PANEL data are 1-2-4-8 weighted at standard 5-V TTL levels ($\leq +0.5$ and $\geq +3.5$ V) and available from all bands sequentially at a 50-pin type 57 connector.

Analog Presentation: BAND NUMBER is available as 0 to +1 V linear ramp at rear BNC connector. BAND LEVEL from 0 to 60 dB is available as 0 to +1 V $\pm 10\%$ signal at rear BNC connector with overload indicated by superimposed jitter. PEAK MONITOR: A peak detector senses levels at two circuit points and drives a panel meter calibrated in dB referred to overload level. A signal proportional to meter indication is available at a rear connector to drive a dc recorder; 1 mA for full-scale reading.

Input: Connects to rear BNC or mike connector. SENSITIVITY: 100 mV rms nominal for full scale. Can be increased to 5 mV with 1560-P40 or -P42 Preamplifier. DYNAMIC RANGE: 60 dB displayed plus 10-dB crest-factor margin at full scale. MAXIMUM INPUT: 35 Vdc, 17 V peak ac. IMPEDANCE: 100 Ω . CALIBRATION: Full-scale and zero-level self calibration provided in two auxiliary channels; panel control allows a calibration factor to be added to digital output; full-scale indication is adjustable from 60 to 159 dB in 1-dB steps.

Attenuation: 18-dB continuous gain adjustment common to all channels plus, optionally, 50-dB attenuation in 1-dB steps with ± 0.25 -dB accuracy (re +25-dB setting) by means of a panel thumbwheel switch for each band. Attenuation of each band is indicated by a dot on panel display and represents the transmission between input and summed output of multifilter. Display has standard 50-dB-per-decade scale factor, 10 dB per in. vertical, 5 in. per decade horizontal. 1925-9670 Transmission Record Sheets available: thin Mylar* sheets, of same size and scale factor as attenuator display, attach to window with self-contained adhesive and can be used to record position of dots in window with china- or glass-marking pencil or crayon.

Response: 30 6-pole Butterworth filters with 1/3-octave effective (noise) bandwidths that conform to ANSI S1.11-1966 Class III (high attenuation) and IEC 225-1966 standards or with 1-octave bandwidths that conform to ANSI S1.11-1966 Class II (moderate rate but highest for octave-band filters) and IEC 225-1966 standards. ACCURACY of center frequency, $\pm 2\%$. LEVEL UNIFORMITY: Within ± 0.50 dB at 25°C, ± 0.75 dB from 0 to 50°C, at center frequency with attenuator at +25 dB. PASSBAND RIPPLE: 0.5 dB max pk-pk. NOISE: $< 15 \mu\text{V}$ equivalent input noise. HARMONIC DISTORTION: $< 0.25\%$ at 1-V output for bands centered below 25 Hz, $< 0.1\%$ at 1-V output for 25 Hz and above. WEIGHTING: A, B, C, conforming to ANSI S1.4, IEC R123, and IEC R179.

Detection: RMS with true (linear) integration. INTEGRATION TIMES: 1/8, 1/4, 1/2, 1, 2, 4, 8, 16, or 32 s; pushbutton controlled. SAMPLING: Sampling rate is changed during integration time to eliminate coherence effects; 1024 samples taken during integration times from 1 to 32 s; below 1 s number of samples reduced in proportion to integration time to a minimum of 128. REPEATABILITY: Better than 1 dB (1 σ limit) for tone burst with duty factor of 1/100 (equivalent to crest factor of 23 dB) when rms levels are < 13 dB below full scale.

Programmability: All panel controls, except output display rate, attenuators, and gain control, are programmable by closures to ground applied to a rear 50-pin type 57 connector.

* Registered trademark of E. I. du Pont de Nemours and Co. Inc.

Supplied: Power cord; 24-pin, 36-pin, and 50-pin type 57 plugs to mate with rear connectors; 5 Transmission Record Sheets,

Available: 1560-P40 and P-42 PREAMPLIFIERS, 1566 MULTICHANNEL AMPLIFIER (input scanner), 1522 DC RECORDER, 1921-P2 STORAGE DISPLAY UNIT, Houston Instruments 6400-024 series plotters, Mohawk Data Sciences model 800 High-Speed Printer. **NOTE:** The 1522 DC Recorder is ideally suited for use with the 1921. A rack model 1522 with a 1522-P1 Pre-amplifier and 1522-9670 Cable Set is available.

Power: 100 to 125 and 200 to 250 V, 50-60 Hz, 152 W.

Mechanical: Bench or rack models. **DIMENSIONS** (wxhxd): Bench, 19.5x19x20 in. (495x483x508 mm); rack, 19x17.5x16 in. (483x445x406 mm). **WEIGHT:** Bench, 95 lb (44 kg) net, 190 lb (87 kg) shipping; rack, 80 lb (37 kg) net, 120 lb (55 kg) shipping.

Description	Catalog Number	
	With Attenuator	
1921 Real-Time Analyzer	Bench	Rack
	Consists of 1926 Multichannel RMS Detector and 1925 Multifilter with one-third-octave bands*	
25 Hz to 20 kHz	1921-9700	1921-9701
12.5 Hz to 10 kHz	1921-9702	1921-9703
3.15 Hz to 2.5 kHz	1921-9704	1921-9705
100 Hz to 80 kHz	1921-9706	1921-9707
		Without Attenuator
25 Hz to 20 kHz	1921-9708	1921-9709
12.5 Hz to 10 kHz	1921-9710	1921-9711
3.15 Hz to 2.5 kHz	1921-9712	1921-9713
100 Hz to 80 kHz	1921-9714	1921-1915
Transmission Record Sheets, pack of ten	1925-9670	

* Other bandwidths available; inquiries are invited.

1921-P2 Storage Display Unit

- especially useful with real-time analyzers
- clear, bright spectrum display
- large 4-by-5-in. viewing area
- bench or rack models

New



Spectrum at a glance As an accessory for the 1921 Real-time Analyzer, the 1921-P2 displays the results of the spectrum analysis — amplitude vs frequency — in a single, easily interpreted format. The display functions of the unit are programmable, and necessary control and deflection voltages are provided by the analyzer.

The 1921-P2 is a slightly modified Tektronix* Type 603 Storage Display Unit. It has all-solid-state circuits, a 6½-inch bistable storage CRT, built-in vertical and horizontal deflection amplifiers, and Z-axis modulation capability. It is supplied with inter-connecting cable for the 1921 analyzer and graticules marked with 1/3-octave standard band numbers, center frequencies, and a decibel scale.

SPECIFICATIONS

Frequency: Dc to 2 MHz for waveform display, in which the X axis represents time. **PHASE SHIFT:** <1° difference between X and Y channels, up to 500 kHz.

Display: 4 in. vertical (Y), 5 in. horizontal (X) display (approx 10x12.5 cm) on 6½-in. flat-faced bistable storage tube. Phosphor similar to P1. **LINEARITY:** <5% difference in voltage

between any 2 deflection increments of 1-in. length vertically, anywhere in display area. **SPREAD:** Early, <5%, horizontally. **SPEED:** >10 in./ms (25 cm/ms), stored line-writing speed. **STORAGE:** Z-axis on-time should be $\geq 4 \mu\text{s}$ to ensure good storage. Viewing time up to 1 h recommended; erasure becomes more difficult if information is stored longer. **ERASURE,** normal erase time: 250 ms.

Supplied: Five graticule grids graduated vertically every 5 dB from 0 to 60 dB and horizontally in 30 bands: 1 each for bands 5 to 34, 11 to 40, 14 to 43, and 20 to 49, and one with bands unmarked.

Power: 90 to 132 and 180 to 264 V, 48 to 440 Hz, 57 W.

Mechanical: Bench or rack models. **DIMENSIONS** (wxhxd): Bench, 8.5x6.5x19.5 in. (216x165x495 mm); rack, 19x5.25x19.5 in. (483x133x495 mm). **WEIGHT:** 18 lb (9 kg) net, 26 lb (12 kg) shipping.

* Registered trademark of Tektronix Inc.

Description	Catalog Number
1921-P2 Storage Display Unit	
Bench Model	1921-9716
Rack Model	1921-9717

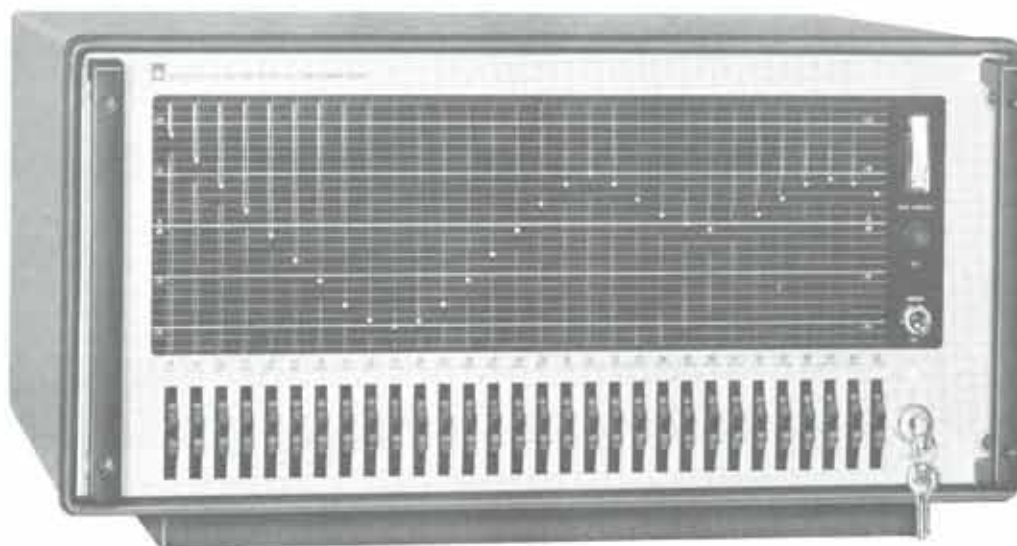

1925 Multifilter

- 3.15 Hz to 80 kHz
- 1/3-octave or octave bands
- calibrated channel attenuators
- display with standard scale factor
- scanned, parallel, and summed outputs

Spectrum shaper or analyzer building block The 1925 Multifilter contains up to 30 parallel octave-band or one-third-octave-band filters from 3.15 Hz to 80 kHz and can be supplied with or without attenuators that permit independent control of the gain in each band. With the attenuators, you can use the multifilter as an equalizer or spectrum shaper to simulate or to compensate for irregularities in the frequency response of electrical or acoustical transmission systems or transducers. With or without attenuators, you can use it as the basis for a serial or parallel frequency analysis system.

A variety of outputs The outputs from the individual filters are presented simultaneously in parallel, summed in a single output, and selected individually by manual switching, by external switch closure, or by a remote scanner control unit. Additional outputs provide the unfiltered input signal and the signal with A, B, or C weighting imposed. Peak detectors located before and after the filters drive a metering circuit that selects the highest peak and gives you an indication in decibels referred to the overload level.

Attenuator for each band Optional attenuators, one for each filter, broaden the usefulness of the multifilter. Each attenuator provides 50 dB of gain control in 1-dB steps, accurate to 0.25 dB. Thumbwheel switches control the attenuation and a panel display indicates the "transmission" of the instrument. This display has the same scale as the 1521-9463 chart paper used with the 1564-A Sound and Vibration Analyzer (5 in./decade horizontal, 10 dB/in. vertical). A key-operated lock guards against unintended changes in the attenuator control settings.

Filters meet American and international standards The filters, built on plug-in etched boards (three per board) for easy interchange, are available with either octave or one-third-octave bandwidths that conform to both American and international standards. The A-, B-, and C-weighting characteristics also conform to the requirements of the various standards for sound-level meters.

— See *GR Experimenter* for May-June 1969 and reprint E122.

SPECIFICATIONS

Frequency: 3.15 Hz to 80 kHz.

Bandwidth: 1/3 or 1 octave standard; 1/10 octave available.

Peak Monitor: A peak detector senses levels at two circuit points and drives a panel meter calibrated in dB referred to overload level. A signal proportional to meter indication is available at a rear connector to drive a dc recorder; 1 mA for full-scale reading.

Input: Connects to rear BNC or microphone connector. **GAIN:** 0 dB nominal. **MAXIMUM INPUT:** 35 V dc, 17 V peak ac. **IMPEDANCE:** 100 k Ω .

Attenuation: +6 to -12-dB continuous gain adjustment common to all channels plus, optionally, +25 to -25-dB attenuation in 1-dB steps with ± 0.25 -dB accuracy (re +25-dB setting) by means of a panel thumbwheel switch for each band. Attenuation of each band is indicated by a dot on panel display and represents the transmission between input and summed output. Display has standard 50-dB per decade scale factor; 10-dB per in. vertical, 5 in. per decade horizontal. Lock on panel prevents accidental changes in attenuator settings.

Response: 30 6-pole Butterworth filters with 1/3-octave effective (noise) bandwidths that conform to ANSI S1.11-1966 Class III (high attenuation) and IEC 225-1966 standards or with 1-octave bandwidths that conform to ANSI S1.11-1966 Class II (moderate rate but highest for octave-band filters) and IEC 225-1966 standards. **ACCURACY** of center frequency: $\pm 2\%$. **LEVEL UNIFORMITY:** Within ± 0.50 dB at 25°C, ± 0.75 dB from 0 to 50°C, at center frequency with attenuator at +25 dB. **PASSBAND RIPPLE:** 0.5 dB max pk-pk. **NOISE:** $< 15 \mu\text{V}$ equivalent input noise. **HARMONIC DISTORTION:** $< 0.25\%$ at 1-V output for bands centered below 25 Hz, $< 0.1\%$ at 1-V output for 25 Hz and above. **WEIGHTING:** A, B, C, conforming to ANSI S1.4, IEC R123, and IEC R179.

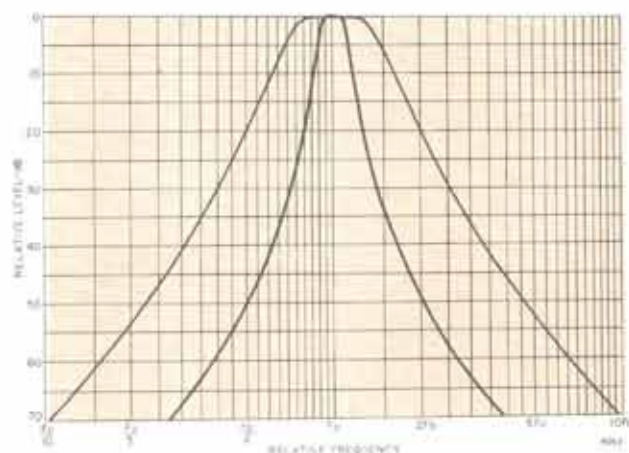

Outputs: **PARALLEL BAND OUTPUTS:** ± 4.2 V max (3 V rms) behind 20 Ω nominal; 3 k Ω min load for max output voltage. **SCANNED BAND OUTPUT:** ± 4.2 V max (3 V rms) behind 20 Ω ; 3-k Ω min load for max output voltage. Two chassis can be wired in parallel for up to 60 scanned outputs. **SUMMED OUTPUT** (for equalizing and shaping applications): ± 4.2 V max open circuit behind 600 Ω ; impedance of load does not affect output linearity. **WEIGHTED AND UNFILTERED OUTPUTS:** 0-dB nominal gain at 1 kHz, behind 20 Ω nominal; 30 k Ω min load for max output voltage.

Supplied: Power cord, two 36-pin type 57 plugs to mate with rear connectors.

1925-9670 Transmission Record Sheets available: thin Mylar* sheets, of same size and scale factor as attenuator display, attach to window with self-contained adhesive and can be used to record position of dots in window with china- or glass-marking pencil or crayon.

Available: 1560-P40 and -P42 PREAMPLIFIERS, 1566 MULTICHANNEL AMPLIFIER (input scanner).

Power: 100 to 125 and 200 to 250 V, 50-60 Hz, 17 W.

Mechanical: Bench or rack models. **DIMENSIONS** (w \times h \times d): Bench, 19.75 \times 9.13 \times 12.25 in. (502 \times 232 \times 311 mm); rack, 19 \times 8.75 \times 12.25 in. (483 \times 222 \times 311 mm). **WEIGHT:** Bench, 49 lb (23 kg) net, 58 lb (27 kg) shipping; rack, 39 lb (18 kg) net, 47 lb (22 kg) shipping.

* Registered trademark of E. I. du Pont de Nemours and Co. Inc.

Description	Catalog Number	
	With Attenuator	
	Bench	Rack
1925 Multifilter **		
One-Third-Octave Bands		
25 Hz to 20 kHz	1925-9700	1925-9701
12.5 Hz to 10 kHz	1925-9702	1925-9703
3.15 Hz to 2.5 kHz	1925-9704	1925-9705
100 Hz to 80 kHz	1925-9706	1925-9707
Octave Bands		
31.5 Hz to 16 kHz	1925-9708	1925-9709
4 Hz to 2 kHz	1925-9710	1925-9711
	Without Attenuator	
One-Third-Octave Bands		
25 Hz to 20 kHz	1925-9712	1925-9713
12.5 Hz to 10 kHz	1925-9714	1925-9715
3.15 Hz to 2.5 kHz	1925-9716	1925-9717
100 Hz to 80 kHz	1925-9718	1925-9719
Octave Bands		
31.5 Hz to 16 kHz	1925-9720	1925-9721
4 Hz to 2 kHz	1925-9722	1925-9723

** 45-band models, 1/10-octave-band models, mixed 1/10, 1/3, and 1-octave-band models, or special bandwidths available on special order.



1926 Multichannel RMS Detector

- 1 Hz to 100 kHz
- 70-dB dynamic range, 60 dB displayed
- digital detection → true rms answers
- fully programmable

Digital detection The 1926 is the digital detector section of the 1921 Real-Time Analyzer and is available separately for use with the 1925 Multifilter or other multichannel filters where real-time analysis is required. It is also useful as a multichannel true-rms detector in other applications such as monitoring the sound pressure at a number of points or measuring the electrical noise of multichannel systems.

—See **GR Experimenter** for May-June 1969 and reprint E122.

SPECIFICATIONS

Frequency: 1 Hz to 100 kHz (3 db down at <1 Hz for bands 1 to 10, at <6 Hz for all other bands; <1-dB frequency-response error at 100 kHz).

Amplitude: 70-dB dynamic range, 60 dB displayed, 1 V rms \pm 10% full-scale sensitivity.

Linearity: \pm 0.5-dB deviation from best straight-line fit over top 50 dB of display range, \pm 1 dB over entire 60-dB range.

Digital Presentation: Band information is displayed on high-intensity neon readout tubes. BAND NUMBER per ANSI S1.6 and S1.11 is displayed on 2 tubes and available as 2 BCD digits on rear panel. BAND LEVEL from 0 to 159 dB in 0.25-dB steps is displayed on 5 tubes and available as 5 BCD digits on rear panel with overload indicated as 8 or 9 in left digit. REAR-PANEL DATA are 1-2-4-8 weighted at standard 5-V TTL levels (\leq +0.5 and \geq 3.5 V; 15-V DTL available on special request) and available from all bands sequentially and automatically in 720 μ s to 45 s for 45 bands or manually by pushbutton or external command, at a rear 50-pin type 57 connector.

Analog Presentation: BAND NUMBER is available as 0 to +1-V

linear ramp at rear BNC connector. BAND LEVEL from 0 to 60 dB is available as 0 to +1 V \pm 10% signal at rear BNC connector with overload indicated by superimposed jitter.

Input: 30 or 45 channels. SENSITIVITY: 1 V rms \pm 10% full-scale. DYNAMIC RANGE: 60 dB displayed plus 10-dB crest-factor margin at full scale. MAXIMUM INPUT: 100 mVdc, 3 V peak ac for linear operation. IMPEDANCE: \approx 5 k Ω ; 0 to 30 Ω allowable source impedance. CALIBRATION: Full-scale and zero-level self-calibration provided in two auxiliary channels; panel control allows a calibration factor to be added to digital output; full-scale indication is adjustable from 60 to 159 dB in 1-dB steps.

Detection: RMS with true (linear) integration. INTEGRATION TIMES: $\frac{1}{8}$, $\frac{1}{4}$, $\frac{1}{2}$, 1, 2, 4, 8, 16, or 32 s; pushbutton controlled. SAMPLING: Sampling rate is changed during integration time to minimize coherence effects; 1024 samples taken during integration times from 1 to 32 s; below 1 s number of samples reduced in proportion to integration time to a minimum of 128. REPEATABILITY: Better than 1 dB (1 σ limit) for tone burst with duty factor of 1/100 (equivalent to crest factor of 23 dB) when rms levels are <13 dB below full scale.

Programmability: All panel control functions, except output display rate, are programmable by closures to ground applied to a rear 50-pin type 57 connector.

Supplied: Power cord, 24, 36, and 50-pin type 57 plugs to mate with rear connectors.

Available: 1522 DC RECORDER, 1921-P1 STORAGE DISPLAY UNIT, Houston Instruments 6400-024 series plotters, Mohawk Data Sciences model 800 High-Speed Printer.

Power: 100 to 125 and 200 to 250 V, 50-60 Hz, 135 W.

Mechanical: Rack model only. DIMENSIONS (wxhxd): 19x 8.75x17.44 in. (483x222x443 mm). WEIGHT: 47 lb (22 kg) net, 55 lb (25 kg) shipping.

Description	Catalog Number
1926 Multichannel RMS Detector	
Rack Model, 30 Channels	1926-9701
Rack Model, 45 Channels	1926-9703



This analyzer represents the most capable, sophisticated signal-processing equipment available anywhere.

T/D Time-Series Analyzers

New Since
Catalog U

- 0-to-50 kHz frequency range
- dynamic range > 70 dB
- frequency resolution to 0.025%
- automatic analysis
- fully calibrated displays
- continuous, on-line real-time acquisition mode
- panel-controlled or keyboard programmed

Tailored analysis The Time/Data 1923 analyzers provide a broad range of time series analysis techniques. Pushbutton selection of such operations as direct or inverse FFT, correlation, Auto Spectrum (PSD), transfer function, etc allow fast, error free and continuous measurements of your input signals. The analyzers are offered in four basic models to suit widely divergent needs. Each model can be tailored to your specific application by either a variety of off-the-shelf options, or special hardware or software unique to your installation — all fully integrated into a unified system.

Two models combine the speed of a microprogrammed Fast Fourier-Transform processor with the flexibility of a digital controller. Another owes its increased speed to the new FTE-10 Fourier Transform Extended Performance Element developed by Time/Data. With this wide choice you need only purchase the performance and speed you really require. If in the future your needs change you can, by adding the FTE-10 or the 90 C or 90 A processor, increase the performance to meet the needs. All models include a full software package and, in addition, custom programming is available for specialized needs.

High-speed analysis These analyzers permit real-time continuous processing without any loss of your data. Processing bandwidths are available up to 38 kHz (auto spectrum) directly from the panel. In addition, the full scale frequency range selection is in sequence steps of 1, 2, 2.5, 4, and 5 from 0.1 Hz to 50 kHz to allow maximum utilization of the bandwidth capability. Widest useful dynamic range is preserved by means of 16-bit words, double-precision calculations, and operator selected dynamic scaling.

Easy analysis A task-oriented control console, meaningful displays, and a complete software package provide true "one-button" operation — there is no need to know or to learn computer programming and no need for constant cable patching or control manipulation.

Complete analysis The system design allows you to construct any desired compound processing and input/output operations for automatic or repetitive data-reduction routines. Parallel processing in both the processor and controller permits wide-band performance. Complex, repetitive sequences can be initiated automatically or at the push of a button, obviating the need for a trained operator to set up and supervise each measurement.

Pre-programmed pushbutton functions:

- DIRECT/INVERSE FFT
- AUTO-/CROSS-SPECTRUM
- TRANSFER/COHERENCE FUNCTION
- AUTO-/CROSS-CORRELATION
- AMPLITUDE HISTOGRAM
- WAVEFORM AVERAGING

Preselected time-domain HANNING available for any function.

— See **GR Experimenter** for July/September 1970.

SPECIFICATIONS

Model	Processing Time					Real-Time Max Bandwidth		Frame-Size (words)	
	FFT Dir or Inverse	Auto Spectrum (PSD)	Cross Spectrum	Auto Spectrum	Cross Spectrum	Single Channel (optional to 8192)	Dual Channel (optional to 4096)		
1923/30	85 ms	950 ms	85 ms	950 ms	1800 ms	0.5 kHz	0.2 kHz	2048	1024
1923/50	13	146	19	215	360	2.3	1.4	2048	1024
1923/70	1.7	17	2.1	22	48	20	10	4096	2048
1923/90	1.2	12.2	1.2	12.6	27	38	18	4096	2048

Dynamic Range: >70 dB, voltage or power.

Frequency Resolution:

Size in Words	Number of Frequency Lines	Analysis Frequency Range in Hz**				
		10,000	20,000	25,000	40,000	50,000
8192*	4096*	2.5*	5*	6.25*	10*	12.5*
4096*	2048*	5*	10*	12.5*	20*	25*
2048	1024	10	20	25	40	50
1024	512	20	40	50	80	100
512	256	40	80	100	160	200
256	128	80	160	200	320	400
128	64	160	320	400	640	800
64	32	320	640	800	1280	1600

* May be optional. ** For lower analysis frequencies, divide Resolution per Line by appropriate power of 10.

On-Line Input: Automatically set up and controlled by selected operations. Buffered mode for continuous acquisition assumed unless inhibited. **CONVERTERS:** Parallel, two-channel 10-bit A-D converters with input impedance of 1 MΩ shunted by <45 pF. **SAMPLING:** Simultaneous two-channel sampling up to 102.4 kHz (50 kHz bandwidth per channel). **ATTENUATORS:** Calibrated in 1, 2, 4 steps for ranges from ±0.1 V to ±2 V. **FEATURES:** Ac/dc coupling. Over-range indication. Programmable AntiAlias Filters (optional) automatically set by selected bandwidth.

Control Modes: **PANEL:** A simple operation with pushbutton preselection of process parameters and complete operation from input start to result display on a single execution command. **KEYBOARD (optional):** Operation for individual process steps and data manipulations. **LEARNED PROGRAM:** For single-command execution of complex operational sequences entered from the keyboard. Additional Keyboard Functions: **BLOCK (ARRAY) ARITHMETIC:** Add, Subtract, Multiply, Divide, Binary Scaling, Exponential Averaging all in Real or Complex mode, single or double precision. **INTEGRATE/DIFFERENTIATE. DECIMATE/EXPAND. CONVERSIONS:** Linear/Log, Polar/Rectilinear. **TRIG:** Sine/cosine tables available for manipulations. **DIRECT CONVOLUTION, Spectral Smoothing** or time domain filtering with complex or real modes

System Controller: DEC PDP-11, 16-bit general-purpose computer with hardware multiply/divide.

Controller Memory: 16-bit x 8k-word, standard (data area = 2k). Up to 28k-word, optional.

Hardware Processors:

1923/30	1923/50	1923/70	1923/90
PDP-11	T/D FTE-10	T/D 90C	T/D 90A

FFT Processor Memory: None needed in the 1923/30 or 1923/50 systems. 4k standard with up to 16k optional in the 1923/70 or 1923/90.

Arithmetic: 16-bit, fixed-point for Fourier Transform; 32-bit for Auto (power) Spectrum; double-precision selectable for many operations.

Display: CRT, 8 x 10 cm, with optional storage capability, completely and accurately calibrated by digital process with panel indication of scales and units. **ANALOG MODE:** For monitoring inputs and trigger conditions. **SAMPLED INPUT OR RESULT** displays. **LINEAR** or **LOG** scales, either axis; vertical presents full 96-dB computational range or choice of two expanded ranges. **COMPLEX DATA** in choice of: Cartesian Real and Imaginary, Polar Magnitude and Phase, Phase Plane (real vs imaginary). **VERTICAL EXPANSION:** Linear scaling or log range shift in 6-dB steps over full double-precision range. **HORIZONTAL EXPANSION:** Any portion of full scale range.

Multiple Frame Averaging, 1 to 16k frames or Continuous, with pushbutton selection of: Uniform Weight Accumulation, Exponential Decay of older results (with adjustable discount factor), Normalizing if desired, Over-flow Protection and Warning.

Options: There are over 60 standard options including teletype, rack cabinet, keyboard, anti-alias filter, high-speed paper tape reader, additional memory segments (for processor or controller), special software, output devices, (such as X-Y plotters, recorders, storage scope), magnetic tape or disk units, etc.

Power: 110 to 125 or 220 to 250 V, 50 or 60 Hz.

Mechanical: **WEIGHT:** 1923/70/90, 1200 lb (544 kg) net; 1923/30/50, 675 lb (306 kg) net.

Warranty: Time/Data products are warranted for parts, labor and transportation during the first three months after customer acceptance.

Description	Catalog Number
Time-Series Analyzer	
T/D 1923/30	(Describe exactly as shown at the left.)
T/D 1923/50	
T/D 1923/70	
T/D 1923/90	
Select following options, if desired:	
OP7 Teletype, ASR-33	
OP20 Rack Cabinet, 70 in.	
OP50 Keyboard and its control software	
OP56 Program-controlled AntiAlias Filter	
OP57 High-speed Paper-Tape Reader (300 cps)	
OTHER: See "Options," in Specifications	

New Since
Catalog U

T/D 1923V Digital Vibration Control System

- random, sine, and transient control
- computer-controlled tests
- automatic failure protection
- selectable frequency resolution and bandwidth
- control dynamic range >60 dB
- automatic hard-copy documentation

Fast, accurate, versatile This system, by Time/Data, represents the first major innovation in vibration testing in over a decade. Until its introduction, a similar function was performed by analog equipment consisting of a noise generator, 80 parallel variable gain band pass filters for shaping of the spectrum, and 80 identical filters for obtaining an approximation to the spectrum of the observed vibrations.

A new generation The T/D 1923V is a digital vibration control system capable of random, sine, and transient control. Its new digital control philosophy, combined with a Fast Fourier Processor and selectable control strategies, assure no-compromise performance and utility.

Inherent in digital techniques is predictable, drift-free performance. The computer controls the test automatically, eliminating human error. It monitors test results, compares these to preset alarm and abort limits, and executes a programmed test shutdown when necessary. Immediately following the test, hard-copy documentation is available automatically.

A new standard of performance Features such as:

- a 96-dB computational dynamic range
- fine resolution spectrum
- high-speed signal processing
- unique signal generating and control algorithms

Control accuracy of $\pm\frac{1}{2}$ dB over greater-than-60-dB control dynamic range is now possible, with control loop response time less than 1 second. This is made possible by the T/D 90A Fast Fourier Processor. It calculates a 512-line spectrum from a 1024-sample data frame in only 12 milliseconds, yielding a real-time bandwidth of 40 KHz. This assures the maximum statistical accuracy in the analysis and generation of the highest Q resonances that are normally encountered in mechanical systems.

Unlike other compromise systems, the high speed of the T/D 90A allows the generation and control of natural random noise, with continuous spectrums, without the undesirable periodicities that result in discrete spectral lines.



Versatility With the T/D 1923V:

- Frequency resolution and spectrum shape can be specified over a wide range.
- Control strategy may be easily changed to suit changing test requirements.
- Convertible within minutes to a T/D 1923 Time-Series Analyzer which accommodates all types of signal analysis.
- The T/D 90A can be interfaced to your central computer, to act as a peripheral processor when not in use for vibration control or analysis.
- The DEC PDP-11 can be used as an independent general-purpose computer, when not in use for vibration control or analysis.

Easy operation Control of the system is through a user-oriented control panel. A Teletype and conversational language are used for test setup. All necessary software is provided, and no computer or programming knowledge is necessary to operate the system. Manual override of computer control is provided.

The 1923V Digital Vibration Control System synthesizes and controls the excitation for vibration testing. The all digital system generates a random (Gaussian) sequence of numbers that are converted to an analog signal. The analog signal provides the excitation to a power amplifier that in turn drives either an electromagnetic or electrohydraulic shaker system. Additionally, the 1923V controls the vibrations experienced by the test specimen by comparing the spectrum of the observed vibrations with a stored reference. The Gaussian signal is controlled and synthesized in the frequency domain. The driving signal is obtained through a discrete Fourier transform performed by a high-speed special purpose Fast Fourier Transform Processor. This also performs the spectral analysis of observed vibrations.

Description The standard T/D 1923 Time-Series Analyzer comprises better than 95% of the hardware of the

1923V system, excluding the shaker. A plug-in control-panel overlay is tailored to each version of the 1923. Software represents the greatest difference between the two systems. The RC-1 software package is designed for random control; SC-1 and TC-1 for sine and transient control, respectively. The TSA-1 analysis software package is available as an option. Within minutes, the system can be converted from a Vibration Control System to a complete Time-Series Analyzer.

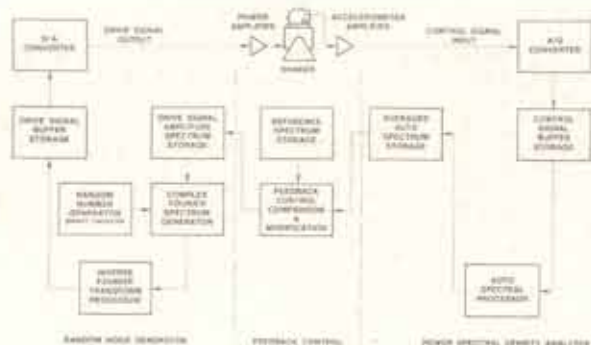

Functional block diagram of vibration control system.

The Time Data 1923V is a complete digital vibration control system for sine, transient, and random tests. Vibration transducers mounted on the test specimen provide input signals through signal conditioning amplifiers, computer-programmed attenuators, and a multiplexer if necessary. The average level or the highest level from each channel may be selected for control. Prior to analog-to-digital conversion, the signals are passed through low-pass anti-aliasing filters, also computer controlled.

The Power Spectral Density is calculated in the Fourier Transform Processor with a choice of 64 to 512 filters

SPECIFICATIONS

Analog Data Input: VOLTAGE LEVEL: Selectable for full-scale range of $\pm 0.1, 0.2, 0.4, 1,$ or 2 V . RANGE: Remotely programmable attenuator covering 60-dB range (1000:1) with 0.1% (10-bit) resolution. RESOLUTION (Filter Bandwidth in Hz):

Frequency Range	Number of Frequency Lines					
	Standard			Optional		
	64	128	256	512	1024	2048
	Resolution (Hz)					
Dc to 500 Hz	8	4	2	1	0.5	0.25
Dc to 1000 Hz	16	8	4	2	1	0.5
Dc to 2000 Hz	32	16	8	4	2	1.0
Dc to 5000 Hz	80	40	20	10	5	2.5

A/D CONVERTER: 10-bit accuracy (including sign), up to 100,000 samples/s rate.

Digital Processor: Digital Equipment Corporation PDP-11. PROCESSING WORD SIZE: 16 bits. READ/WRITE MEMORY: 8,192 words standard, expandable to 28,672 words, or optionally to 124k words. MEMORY SPEED: Full cycle in $1.2\ \mu\text{s}$. Advanced hardware architecture.

Fourier Processor: Time/Data 90A. PROCESSING WORD SIZE: 16 bits. DATA MEMORY SIZE: 4,096 words, expandable to 8,192 words; 900-ns cycle time. SINE/COSINE MEMORY: self-contained in read-only memory with 50 ns access time. PROCESSING TIME: 12 ms for a 1024-real-word Fourier Transform or Auto Spectrum. CALCULATION DYNAMIC RANGE: For Fourier Transform, 16 bits or 96 dB. For Auto Spectrum, 32 bits or 96 dB.

Random Control Performance: CONTROL ACCURACY and CORRECTION SPEED: $\pm 0.5\text{ dB}$ in less than 1.0 s over a 60-dB dynamic range. OPTIONS: (1) Concurrent second-channel

(optional to 2048) based on the required control resolution. System control bandwidth is selectable up to a 5 kHz frequency range. The Fourier spectra produced are similar to the output of a conventional parallel filter set in an analog control system, except that the digital system yields accuracy and stability heretofore unobtainable: for example, a ripple factor of $\pm 0.01\text{ dB}$!

Continuous PSD calculations are made. The reference PSD is compared to the actual PSD in the computer, and a correction is made of the spectral content of the new input excitation. The statistical characteristics of the random test signal are selectable — either to duplicate the natural Gaussian-distributed noise of conventional analog control systems or to produce a zero-variance random test signal, allowing a much faster loop response time. The test engineer also has the choice of combining both types of noise during a test to give a "coarse" and "fine" control range. The use of zero-variance noise permits, for the first time:

- Valid short-term testing, enabled by rapid stabilization of test conditions.
- Simulation of rapidly changing environments, such as might be experienced in a missile being launched.

The Shaker drive signal from the shaped-spectrum noise generator is provided to the power amplifier through a digital-to-analog converter and programmable attenuators. For all tests, a greater-than-60-dB control dynamic range is available. Concurrent with the generation of the shaker input signal, the system calculates the PSD of the control signal and stores it in the computer — both as a time-weighted average PSD for control purposes and as a total accumulated PSD for the final test record. During the test, a real-time CRT display allows monitoring the degree of compliance of the control PSD to the reference PSD.

Auto Spectrum Analysis. (2) Concurrent second-channel Cross Spectrum and Transfer Function Analyses.

Sine Control Performance: FREQUENCY: Range, 0.5 Hz to 5 kHz; accuracy, within 0.2%; resolution, 0.1% over the frequency range. HARMONIC DISTORTION: Less than 1%. SWEEP (Logarithmic): Rate, 0.01 to 10.0 octaves/minute; resolution, 0.1%. CONTROL: Dynamic Range, $> 60\text{ dB}$. Modes: Acceleration, Velocity, or Displacement. OPTIONS: Resonant Dwell; Concurrent Co-Quad Analysis.

Transient Control Performance: The measured transfer function of the system under test is used to synthesize a shaker excitation pulse that will produce the desired shock waveform at the test specimen.

Control: Provided by user-oriented control panel. Functions include full array of test controls, display controls, back-lighted system status messages, manual override, and selection of input and output voltage levels.

System Setup: Through Teletype, with conversational language for all test parameters, alarm limits, and abort limits. Test parameters are displayed on Teletype or on CRT in alpha-numerics.

Data Output: The system includes CRT display and X-Y-plotter outputs.

Optional Analysis Mode: The system can provide you with the complete T/D 1923 analysis capability after a change of the control console overlay panel and loading a suitable program from appropriate software. (See T/D 1923 for performance capabilities and specifications.)

Warranty: Time/Data products are warranted for parts, labor and transportation during the first three months after customer acceptance.

Test-System Building Blocks

Low-Frequency Oscillators 2 Hz – 2 MHz

General Radio's low-frequency oscillators are of the RC Wien-bridge type, which, when designed using modern solid-state devices, can provide a combination of wide frequency range, low noise distortion, and stable output in a reliable and inexpensive instrument.

In the Wien-bridge oscillator the frequency is determined by passive resistors and capacitors; both can be made very stable with time and temperature. Tuning is accomplished with a variable air capacitor, which provides continuous adjustment without jumps, or with switched resistances that vary frequency in discrete steps. Both offer advantages, depending upon the application: infinite resolution or fast, repeatable frequency selection.

For greater frequency stability, the oscillator can have its frequency locked to an external signal by means of a synchronization input. All the oscillator's output characteristics are maintained and the long-term frequency stability is the same as the external signal.¹ By this means, also, the oscillator can filter out noise and distortion in an applied signal, while providing the output amplitude and shortability of the normal oscillator. Short-term frequency instability or jitter can be reduced also.

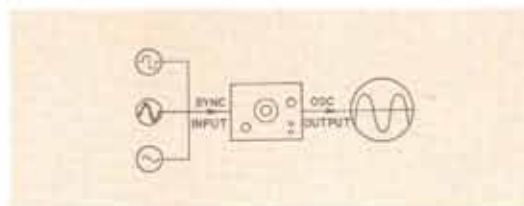

Oscillator filters, amplifies, isolates, multiplies frequency

With a unique type of amplitude regulator circuit,² the output of an RC oscillator is held very constant, regardless of changes in the output frequency. This regulator circuit operates without increasing distortion, and the output is so constant that an analog voltmeter will not move as the frequency is changed, providing that the oscillator is properly terminated so reactive loading effects are insignificant.

¹ See GR Instrument Note IN-109, "Principles and Applications of RC Oscillator Synchronization," 1966.

² R. E. Owen, "Solid State RC Oscillator Design for Audio Use," Journal of the Audio Engineering Society, January 1966, available from GR as reprint A-125.

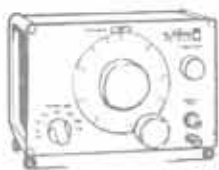

GR 1310

- 2 Hz to 2 MHz
- 20 V ■ 0.25% distortion

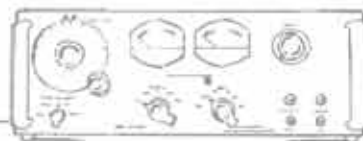

GR 1308-A

- 200 VA ■ 400 V or 5 A
- 20 Hz to 20 kHz ■ transformer output



GR 1309-A

- 0.05% distortion ■ sine and square waves
- 10 Hz to 100 kHz ■ 5 V
- 60-dB step attenuator



GR 1311-A

- 1 watt ■ 100 V or 4 A
- transformer output
- 50 Hz to 10 kHz ■ discrete frequencies

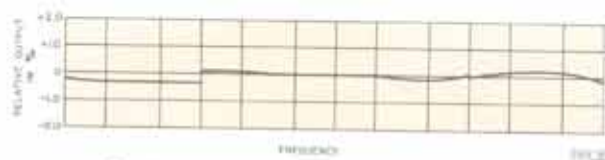

Constant output voltage vs frequency change

The oscillator output may be made available through a constant-impedance attenuator, a tapped transformer, or a combination. The constant-impedance attenuator is most commonly used because of its convenience in the control of loading effects — cable-capacitance shunting or low-impedance loads, for example.

Also convenient is an attenuator position that removes the oscillator voltage yet maintains the output impedance. Thus you can set the output to zero without changing the variable control or shorting shielded connections. Since the impedances all remain the same, effects of ground loops and other noise sources are unchanged, while you verify that they are negligible (or analyze them for corrective action) with the oscillator output removed.



Zero-output position on attenuator

Transformer-output circuitry offers a selection of output impedances for maximizing power into a load or for maintaining a sinusoidal current or voltage with nonlinear loads. Further, transformers provide isolation of the output for ungrounded or balanced operation and a low-impedance dc path through the source.

The synchronization jack (when not used as an input) also provides an output of the order of one volt, a convenience for triggering a counter or an oscilloscope. This auxiliary output is independent of the main-output level setting.

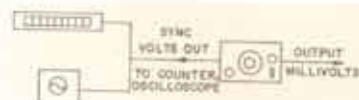

Using sync output

The distortion in the output of a solid-state RC oscillator can be quite low with a properly designed amplitude regulator. It will be lowest in the middle of its frequency range and increase at the extremes in a manner similar to many devices apt to be tested.

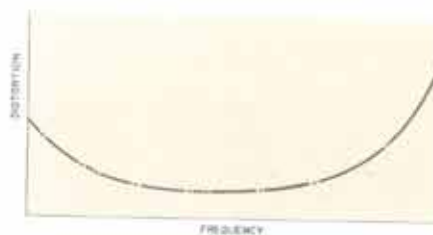

Distortion is lowest at frequencies that matter most

Maintaining low distortion under all load conditions is desirable and is made practical with solid-state design. Output waveform will not be clipped even when short-circuited at maximum output.



No clipping of output current, even into a short circuit

These many features have been combined in the oscillators described in the following pages. The combination in each case attempts to satisfy the requirements of broad application areas. As the chart below reveals, frequency range alone is not the greatest distinction between them.

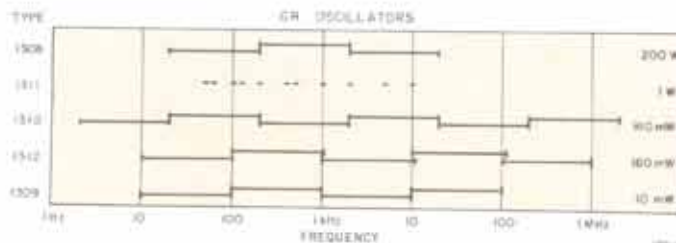



1308-A Audio Oscillator and Power Amplifier

- 200-VA output, up to 400 V or 5 A
- 20 Hz to 20 kHz
- output transformer

The 1308-A Audio Oscillator and Power Amplifier is an ac power source covering the audio range. It is an excellent power source for the 1633-A Incremental-Inductance Bridge. Its low dynamic output impedance enhances its usefulness as a power source for general testing over a wide range of supply frequencies. This instrument will provide a low-distortion signal for nonlinear loads, such

as capacitor-input rectifier systems, without clipping. It can also be used to drive small shake tables and to isolate sensitive equipment from power-line transients.

The 1308 also finds many uses as an audio-frequency power amplifier. When it is used with the 1396 Tone-Burst Generator, high-power tone bursts are provided for testing sonar projectors, amplifiers, etc.

This instrument combines a capacitor-tuned, Wien-bridge oscillator, a low-distortion power amplifier, and a tapped output transformer. The output is monitored by an overload circuit, which turns off the output when it starts to exceed safe limits.

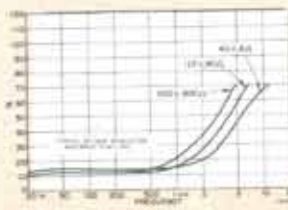
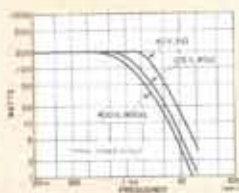
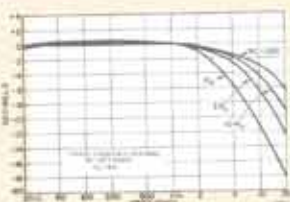

SPECIFICATIONS

Frequency Range: 20 Hz to 20 kHz in 3 ranges. **CONTROLS:** Continuously adjustable main dial covers decade range in 157.5°, vernier in 2 turns.

Accuracy: ±3% of setting or ±1 Hz, whichever is greater.

Frequency Stability (typical at 1 kHz): Warmup drift at full load, 0.3%. After warmup: 0.003% short term (10 min), 0.03% long term (12 h), 0.04% from no load to full load.

Output Voltage Ranges: Max of 4, 12.5, 40, 125, and 400 V open circuit, continuously adjustable from 0 to max.

Output Power: 200 VA max, 50 Hz to 1 kHz. **CURRENT RANGES:** Max of 0.016, 0.05, 0.16, 0.5, 1.6, and 5.0 A.

Regulation: <20%, no load to full load, 20 Hz to 1 kHz. Output impedance is typically 0.3, 0.8, 1.6, 19, and 220 Ω, depending on voltage range, 20 Hz to 1 kHz. Output transformer can pass dc current equal to max of ac current range. Output isolated from ground.

Load Impedances: Short circuit or non-linear loads can be driven. Load impedances of 0.8, 2.5, 8, 80, or 800 Ω, depending on voltage range, are optimum for max available power. **LOAD POWER FACTOR:** Continuous operation at max VA for any power factor 0 to 1 with ambient up to 25°C. Power factor of 0.7 to 1.0 for continuous operation to 40°C ambient. Intermittent operation to 50°C.

Distortion (linear load): <1%, 100 Hz to 10 kHz; <2%, 50 Hz to 100 Hz at max power and 115-V supply.

Hum: <0.3% of max output.

Meters: Indicate output terminal voltage and current.

Voltmeter: 5, 15, 50, 150, and 500 V ±3% full scale.

Ammeter: 0.016, 0.05, 0.16, 0.5, 1.6, and 5 A ±3% f.s.

Overload Protection: Electronic overload trips at approx 1.5 × max of current range (manual reset), thermal cut-out on transistor heat sink (automatic reset).

Amplifier Sensitivity: <2.0 V for full output.

Input Impedance: 10 kΩ.

Terminals: Output, GR 938 Binding Posts and four-terminal socket on rear panel; input, GR 938 Binding Posts on rear panel.

Supplied: Four-terminal plug, power cord.

Power: 105 to 125 or 210 to 250 V, 50 to 60 Hz, 70 to 500 W, depending on load.

Mechanical: Rack-bench cabinet. **DIMENSIONS** (wxhxd): Bench, 19x7x16.25 in. (483x178x413 mm); rack, 19x7x15 in. (483x178x381 mm). **WEIGHT:** 91 lb (42 kg) net, 145 lb (66 kg) shipping.

Description

1308-A Audio Oscillator and Power Amplifier

115-V Bench Model	1308-9801
115-V Rack Model	1308-9811
230-V Bench Model	1308-9802
230-V Rack Model	1308-9812

Catalog
Number

1308-9801
1308-9811
1308-9802
1308-9812



1309-A Oscillator

- 10 Hz to 100 kHz
- 0.05% distortion
- 5-V sine- or square-wave output
- 60-dB step attenuator

The 1309-A is particularly well suited for distortion measurements, in addition to its obvious value as a general-purpose laboratory oscillator. Distortion, noise, and hum are exceptionally low, and output is flat over the entire frequency range.

The output attenuator can be set for zero volts behind 600 ohms, a useful condition for measuring low-level noise and extraneous signals.

A square wave with 40-ns rise time is also available for transient-response tests. The waveform has good symmetry at all frequencies and no low-frequency tilt.

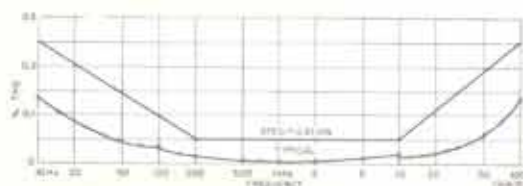

Third-harmonic distortion

SPECIFICATIONS

Frequency Range: 10 Hz to 100 kHz in 4 decade ranges. Overlap between ranges, 5%.

Accuracy: $\pm 2\%$ of setting.

Stability (typical at 1 kHz): Warmup drift, 0.3%. After warm-up: 0.001% short term (10 min), 0.01% long term (12 h).

Controls: Continuously adjustable main dial covers decade range in 305°, vernier in 4 turns.

Synchronization: Frequency can be locked to external signal. Lock range $\pm 3\%$ per volt rms input up to 10 V. Frequency dial functions as a phase adjustment.

Sine-Wave Output Voltage: 5.0 V $\pm 5\%$ open circuit. POWER: >10 mW into 600 Ω , IMPEDANCE: 600 Ω . One terminal grounded.

Attenuation: Continuously adjustable attenuator with >20 -dB range, and 60-dB step attenuator with 20 ± 0.2 dB per step and a zero-volt position with 600- Ω output impedance maintained.

Distortion: $<0.05\%$, 200 Hz to 10 kHz, increasing to $<0.25\%$ at 10 Hz and 100 kHz, into open circuit or 600- Ω load. (See curve.)

Hum: <50 μ V independent of attenuator setting ($<0.001\%$ of full output).

Sine Amplitude vs Frequency: $\pm 2\%$ for loads of ≥ 600 Ω .

Synchronization: Constant-amplitude (1.5-V), high-impedance (12-k Ω) output to drive counter or oscilloscope.

Square-Wave Output: VOLTAGE: $>+5.0$ V pk-pk open circuit. Dc-coupled output. IMPEDANCE: 600 Ω . One terminal grounded. RISE TIME: <100 ns into 50- Ω load. Typically 40 ns at full output. SYMMETRY: $\pm 2\%$ (48 to 52% duty ratio). ATTENUATION: Continuously adjustable attenuator with >20 -dB range.

Terminals: Output, GR 938 Binding Posts; sync, side-panel telephone jack.

Available: ADAPTOR CABLE 1560-P95 (telephone plug to double plug), 0480-9838 SET to rackmount 1309 alone, 0480-9880 SET to rackmount 1309 side-by-side with same-size instrument such as the 1310 Oscillator, 1369 Tone-Burst Generator, or 1232 Amplifier-Detector.

Power: 100 to 125 or 200 to 250 V, 50 to 400 Hz, 6 W.

Mechanical: Convertible-bench cabinet. DIMENSIONS (wx hxd): 8x6x8.13 in. (204x153x207 mm). WEIGHT: 7 lb (3.1 kg) net, 9 lb (4.1 kg) shipping.

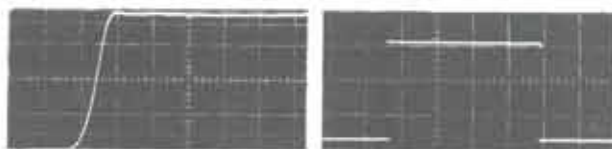

(Left) 10 kHz square-wave into 50 ohms, 50 ns/div, horiz. (Right) Direct-coupled 10-Hz, square-wave. Note flat top. 10 ms/div, horiz.

Description	Catalog Number
1309-A Oscillator	1309-9701
1560-P95 Adaptor Cable	1560-9695
480-P308 Rack-Adaptor Set	0480-9838
480 Rack-Adaptor Set	0480-9880

Ⓜ Federal stock numbers are listed before the index.



1310-B Oscillator

- 2 Hz to 2 MHz
- 20-V, constant output, $\pm 2\%$
- 0.25% distortion

The superior characteristics of this oscillator make it an exceptionally useful laboratory signal source.

Constant output over a very wide frequency range facilitates frequency-response measurements.

High-resolution dial and exceptional amplitude and frequency stability are important for measurements of filters and narrow-band devices.

Equally useful in 600-ohm and 50-ohm circuits, since distortion is independent of load, even a short circuit.

When phase-locked to a frequency standard, the oscillator can deliver a high-level standard-frequency output with adjustable amplitude and low distortion.

Description A capacitance-tuned, RC Wien-bridge oscillator drives a low-distortion output amplifier, which isolates the oscillator from the load and delivers a constant voltage behind 600 ohms. All solid-state circuits ensure long, trouble-free life.

A jack is provided for introduction of a synchronizing signal for phase locking or to furnish a signal, independent of the output attenuator setting, to operate a counter, or to synchronize an oscilloscope or another oscillator.

Note: This product is manufactured also in Europe.

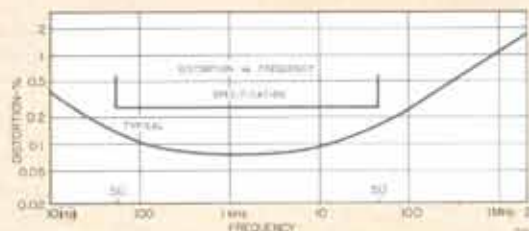

SPECIFICATIONS

Frequency Range: 2 Hz to 2 MHz in 6 decade ranges. Overlap between ranges, 5%.

Accuracy: $\pm 3\%$ of setting.

Stability (typical at 1 kHz): Warmup drift, 0.1%. After warm-up: 0.003% short term (10 min), 0.03% long term (12 h).

Controls: Continuously adjustable main dial covers decade range in 305°, vernier in 4 turns.

Synchronization: Frequency can be locked to external signal. Lock range $\pm 3\%$ per volt rms input up to 10 V. Frequency dial functions as phase adjustment.

Output Voltage: 20 V open circuit, nominal.

Power: ≥ 160 mW into 600 Ω .

Output Impedance: 600 Ω . One terminal grounded.

Attenuation: Continuously adjustable attenuator with >46 -dB range.

Distortion: $<0.25\%$, 50 Hz to 50 kHz with any linear load. Oscillator will drive a short circuit without clipping.

Hum: $<0.02\%$, independent of attenuator setting.

Amplitude vs Frequency: $\pm 2\%$, 20 Hz to 200 kHz, into open circuit or 600- Ω load.

Synchronization: Constant-amplitude (0.8-V), high-impedance (27-k Ω) output to drive counter or oscilloscope.

Terminals: Output, GR 938 Binding Posts; sync, side-panel telephone jack.

Available: ADAPTOR CABLE 1560-P95 (telephone plug to double plug); 0480-9838 SET to rackmount 1310 alone; 0480-9880 SET to rackmount 1310 side-by-side with same-size instrument such as the 1309 Oscillator, 1369 Tone-Burst Generator, or 1232 Amplifier-Detector.

Power: 105 to 125, 195 to 235, or 210 to 250 V, 50 to 400 Hz, 12 W.

Mechanical: Convertible-bench cabinet. DIMENSIONS (wx hxd): 8x6x8.13 in. (204x153x207 mm). WEIGHT: 7.75 lb (3.6 kg) net, 10 lb (4.6 kg) shipping.

Description	Catalog Number
1310-B Oscillator	
115-V Model	1310-9702
220-V Model	1310-9703
230-V Model	1310-9704
1560-P95 Adaptor Cable	1560-9695
0480-P308 Rack-Adaptor Set	0480-9838
480 Rack-Adaptor Set	0480-9880



1311-A Audio Oscillator

- 50 Hz to 10 kHz, discrete frequencies
- 1 W, 100-V or 4-A output
- transformer output

The 1311 oscillator offers high-power output and load-matching through a multitap output transformer that ensures at least $\frac{1}{2}$ watt into any load from 0.08 to 8000 ohms. Thus, it is ideal for driving impedance bridges where high sensitivity is required at extreme measurement limits and for driving directly such low-impedance devices as acoustic transducers. For bridge measurements, the shielded output-transformer secondary minimizes circulating ground currents. The 1311 is supplied in an assembly with the 1232 Tuned Amplifier and Null Detector as the 1240 Bridge Oscillator-Detector. The 1311 is also included in several GR impedance-measuring systems.

Typical output characteristics

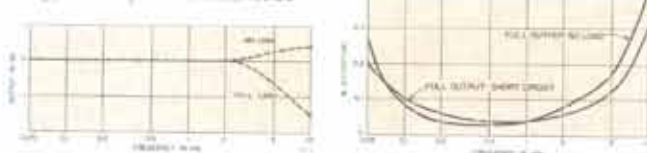

SPECIFICATIONS

Frequency Range: 50 Hz to 10 kHz. Eleven fixed frequencies; 50, 60, 100, 120, 200, 400, and 500 Hz, 1, 2, 5, and 10 kHz. One other frequency can be added at an unused switch position. A Δf control provides $\pm 2\%$ continuous adjustment.

Accuracy: $\pm 1\%$ of setting with Δf control at zero.

Stability (typical at 1 kHz): Warmup drift, 0.3%. After warm-up: 0.008% short term (10 min), 0.02% long term (12 h).

Synchronization: INPUT: Frequency can be locked to external signal. Lock range, $\pm 3\%$ per volt rms up to 10 V. The Δf control functions as a phase adjustment. OUTPUT: Constant amplitude (1 V) to drive counter or oscilloscope. Source impedance 4.7 k Ω .

Output Level: VOLTAGE: Continuously adjustable from 0 to 1, 3, 10, 30, or 100 V open circuit (E_{oc}), dependent on setting of 5-position output switch. CURRENT: Continuously adjustable from 0 to 40, 130, 400, 1300, or 4000 mA, into approx short circuit (I_{sc}). POWER: >1.0 W into matched load, >0.5 W into any resistive load between 80 m Ω and 8 k Ω .

Output Impedance: One to three times $\frac{E_{oc}}{I_{sc}}$, depending on output amplitude. Output ungrounded.

Distortion: $<0.5\%$ with any linear load. Oscillator will drive a short circuit without clipping.

Hum: $<0.01\%$, independent of output setting.

Terminals: Output, GR 938 Binding Posts and ground terminal with shorting link; sync, telephone jack on side panel.

Available: ADAPTOR CABLE 1560-P95 (telephone plug to double plug), 0480-9838 SET to rackmount 1311-A alone, 0480-9880 SET to rackmount 1311-A side-by-side with same-size instrument such as 1310 Oscillator, 1369 Tone-Burst Generator, or 1232 Amplifier-Detector.

Power: 105 to 125 or 210 to 250 V, 50 to 400 Hz, 22 W.

Mechanical: Convertible-bench cabinet. DIMENSIONS (wx hxd): 8x6x7.75 in. (204x153x197 mm). WEIGHT: 6 lb (2.8 kg) net, 9 lb (4.1 kg) shipping.

Description

Description	Catalog Number
1311-A Audio Oscillator	
115-V Model Φ	1311-9701
230-V Model	1311-9702
1560-P95 Adaptor Cable	1560-9695
480-P308 Rack-Adaptor Set	0480-9838
480 Rack-Adaptor Set	0480-9880

Φ Federal stock numbers are listed before the index.

Random-Noise Generators

Electrical noise is, by definition, any unwanted disturbance and its reduction in communications circuits is a constant aim of the engineer. Noise from a controlled source, however, is useful in studying the effectiveness of systems for detecting and recovering signals in noise. Well defined random noise is, moreover, a remarkably useful test signal that has, for many measurements, properties that are more useful than those of a single-frequency signal. Its wide spectrum sometimes permits one test with random noise to replace a series of single-frequency tests. Noise is also useful in simulating speech, music, or communications circuit traffic.

Noise is called random if its instantaneous amplitude at any future instant is unpredictable. Random noise is specified by its amplitude distribution and by its spectrum. Many types of naturally occurring electrical noise have the same distribution of amplitudes as do errors that

normally occur in experimental measurements — the normal or Gaussian distribution. In general-purpose noise generators the design objective is random noise that is Gaussian and has a uniform spectrum level over the specified frequency range.

The General Radio random-noise generators produce electrical noise at high output levels, each model having been designed for specific uses. The 1381 is useful for many audio-frequency applications, and also in vibration testing as its spectrum extends well into the subaudio range. The 1382 is intended for audio-frequency electrical, acoustical, and psychoacoustical applications. The 1390-B is useful at higher frequencies because its spectrum extends to 5 MHz. The 1383 generates wide-band noise of uniform spectrum level and is particularly useful for tests in video- and radio-frequency systems.

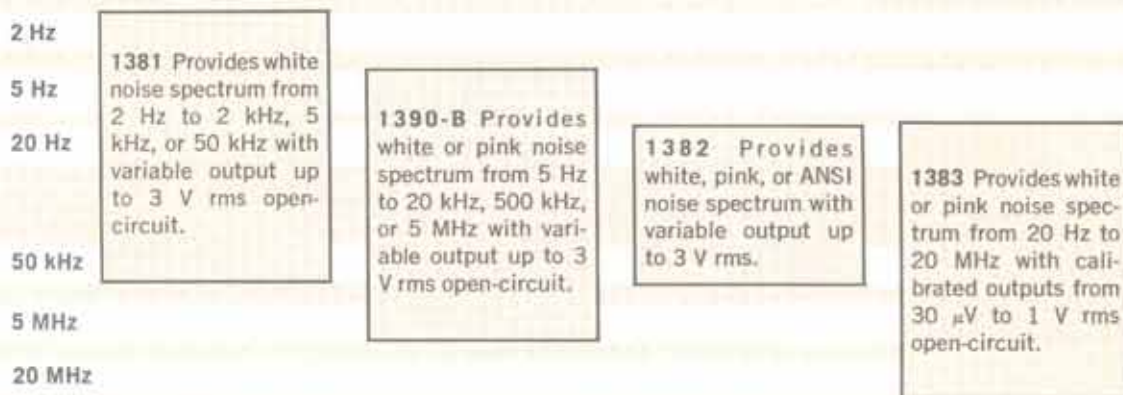

1381 and 1382 Random-Noise Generators

GR 1381

- 2 Hz to 2, 5, or 50 kHz, Gaussian distribution
- adjustable clipping
- 3-V rms output

GR 1382

- 20 Hz to 50 kHz, Gaussian distribution
- white, pink, or ANSI spectra
- 3-V rms output, balanced, unbalanced, or floating

Predictably random The 1381 and 1382 are companion instruments that generate truly random noise from a semiconductor source. Special precautions are taken to ensure a symmetrical, Gaussian amplitude distribution. Output level is adjustable from below 3 millivolts to 3 volts rms behind a 600-ohm source impedance. Each model is constructed in a 3½-inch-high, half-rack-

width cabinet, convenient for bench use and two can be mounted side-by-side in a relay rack.

Either of these noise generators can be used for simulation of noise in signal paths, as test-signal sources, or for demonstrations of statistical and correlation principles. The different features of the two offer a choice to match your needs.

Lowest frequency The 1381 generates noise that is flat down to 2 Hz and is intended for random-vibration tests and for general-purpose use in the audio and sub-audio range. The upper-frequency limit (at -3 dB) can be switched to 2, 5, or 50 kHz. The output signal can be clipped symmetrically at 2, 3, 4, or 5 times the rms amplitude.

Pink or white The 1382 generates noise in the 20-Hz to 50-kHz band and is intended for electrical, acoustical, and psycho-acoustical tests. It offers three spectra, white (flat), pink (-3 dB per octave), and ANSI (see specifications). The output can be taken balanced or unbalanced, floating or grounded.

— See *GR Experimenter* for January 1968 and March-April 1969.

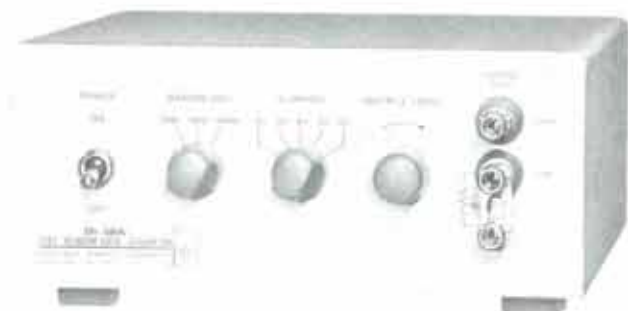

GR 1381

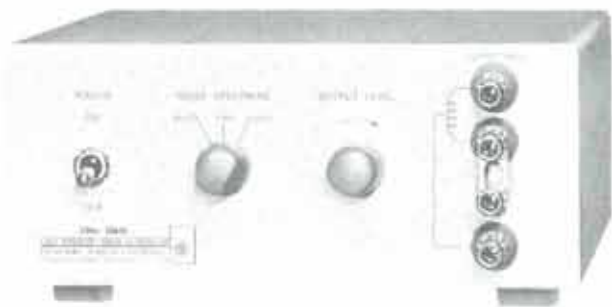

GR 1382

1381 and 1382 Random-Noise Generators (Cont.)

SPECIFICATIONS

Spectrum of 1381: SHAPES: Flat (constant energy per hertz of bandwidth) ± 1 dB from 2 Hz to half of cutoff. CUTOFF FREQUENCY (down 3 dB): 2, 5, or 50 kHz, selected by switch. SPECTRAL DENSITY, at 3-V output level and for 1-Hz bandwidth: 64, 40, and 13 mV, approx, respectively for upper cutoff frequencies of 2, 5, and 50 kHz. SLOPE of amplitude vs frequency above upper cutoff: 12 dB/octave. See graph.

Spectrum of 1382: Choice of 3 shapes. WHITE NOISE (flat spectrum, constant energy per hertz bandwidth): ± 1 dB, 20 Hz to 25 kHz, with 3-dB points at approx 10 Hz and 50 kHz; PINK NOISE (constant energy per octave bandwidth): ± 1 dB, 20 Hz to 20 kHz; or ANSI NOISE, as specified in ANSI Standard S1.4-1961. See graph.

Waveform:

Voltage	Gaussian Probability-Density Function	Amplitude-Density Distribution of 1381/1382
0	0.0796	0.0796 ± 0.005
$\pm 1\sigma$	0.0484	0.0484 ± 0.005
$\pm 2\sigma$	0.0108	0.0108 ± 0.003
$\pm 3\sigma$	0.000898	0.000898 ± 0.0002
$\pm 4\sigma$	0.0000274	0.0000274 ± 0.00002

These data measured in "windows" of 0.2σ , centered on the indicated values of voltage; σ is the standard deviation or rms value of the noise voltage.

Clipping: The output of the 1381 can be clipped internally to remove the occasional wide extremes of amplitude. Clipping, if desired, is adjustable to approx 2, 3, 4, or 5σ . Such clipping has negligible effect on the spectrum or the rms amplitude.

Output: VOLTAGE: >3 V rms max, open-circuit, for any bandwidth. CONTROL: Continuous adjustment from that level down approx 60 dB. IMPEDANCE: 600 Ω . Can be shorted without causing distortion. 1381 output is unbalanced; 1382 output is floating, can be connected balanced or unbalanced. TERMINALS: 1381 output at front-panel binding posts and rear-panel BNC connector; 1382 output at front-panel binding posts and rear-panel jacks for double plugs.

Supplied: Power cord, rack-mounting hardware with rack models.

Power: 100 to 125 or 200 to 250 V, 50 to 400 Hz, 6 W.

Mechanical: Convertible bench cabinet. DIMENSIONS (wx hxd): Bench, 8.5x3.87x9.87 in. (216x98x250 mm); rack, 19x3.5x9 in. (483x89x229 mm). WEIGHT: 7 lb (3.2 kg) net, 10 lb (4.6 kg) shipping.

Description

Random-Noise Generator

Description	Catalog Number
1381 (2 Hz to 50 kHz), Bench	1381-9700
1381 (2 Hz to 50 kHz), Rack	1381-9701
1382 (20 Hz to 50 kHz), Bench	1382-9700
1382 (20 Hz to 50 kHz), Rack	1382-9701

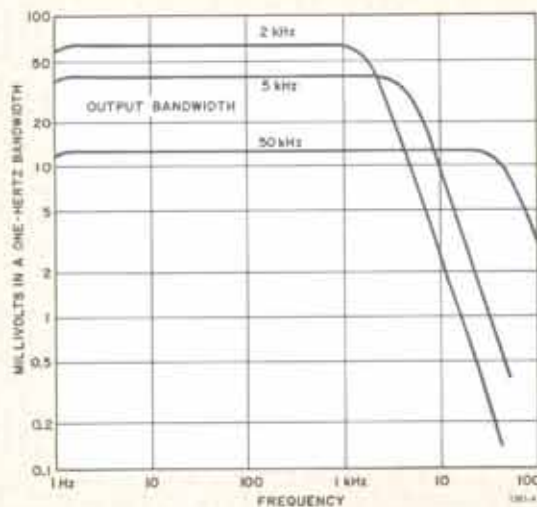

Type 1381

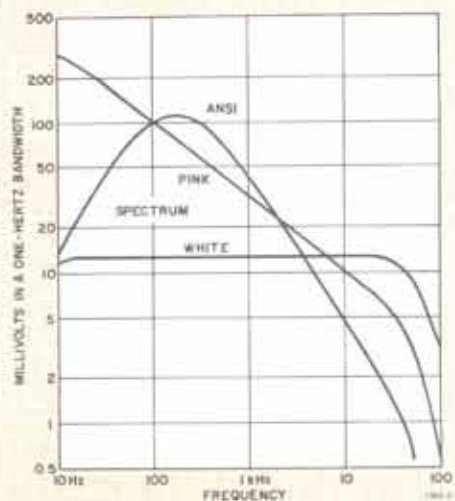

Type 1382



1383 Random-Noise Generator

- 20 Hz to 20 MHz, ± 1.5 dB
- 30- μ V to 1-V output, open-circuit
- 50-ohm output impedance
- meter and 10-dB-per-step attenuator

This instrument generates wide-band noise of uniform spectrum level, particularly useful for tests in video- and radio-frequency systems.

The maximum output is one volt open circuit from a 50-ohm source. An 8-step attenuator of 10 dB per step permits reduction of the output level to 30 μ V.

Use the 1383 as a broad-band noise source for

- intermodulation and cross-talk tests
- simulation of noise in carrier systems
- noise-interference tests in radar and telemetry
- determining noise bandwidth
- measuring noise figure
- setting transmission levels in communication circuits
- statistical demonstrations in classroom and lab
- determining meter response characteristics
- measuring noise temperature

— See **GR Experimenter** for March-April 1969.

SPECIFICATIONS

Spectrum: Flat (constant energy per hertz of bandwidth) ± 1 dB from 20 Hz to 10 MHz, ± 1.5 dB from 10 MHz to 20 MHz.

Waveform: Table shows amplitude-density-distribution specifications of generator compared with the Gaussian probability-density function, as measured in "windows" of 0.2σ , centered on the indicated values of voltage:

Voltage	Gaussian Prob. Dens. Function	Amplitude-Density Dist. of 1383 Random-Noise Gen.
0	0.0796	0.0796 \pm 0.005
$\pm\sigma$	0.0484	0.0484 \pm 0.005
$\pm 2\sigma$	0.0108	0.0108 \pm 0.003
$\pm 3\sigma$	0.000898	0.000898 \pm 0.0003

(σ is the standard deviation or rms value of the noise voltage.)

Output: VOLTAGE ≥ 1 V rms open circuit, at full output. **CONTROL:** Continuous control and 8-step attenuator of 10 dB/

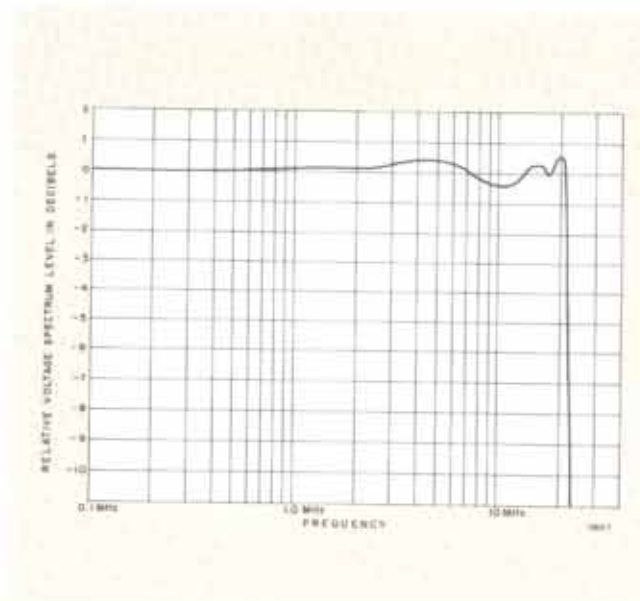

Typical spectrum of 1383 Random-Noise Generator output; energy-per-Hz bandwidth vs frequency.

step. **METER:** Indicates open-circuit output voltage ahead of 50 Ω . **IMPEDANCE:** 50 Ω . Can be shorted without causing distortion. **TERMINALS:** GR874[®] coaxial connector that can be mounted on either front or rear panel.

Power: 100 to 125 or 200 to 250 V, 50 to 400 Hz, 40 W.

Mechanical: Convertible bench cabinet. **DIMENSIONS** (w x h x d): Bench, 17x3.87x12.75 in. (432x98x324 mm); rack, 19x3.5x10.75 in. (483x90x273 mm). **WEIGHT:** 14 lb (6.5 kg) net, 21 lb (10 kg) shipping.

Description

1383 Random-Noise Generator
Bench Model
Rack Model

Catalog
Number

1383-9700
1383-9701



Random-Noise Generator with Pink-Noise Filter plugged in.

1390-B Random-Noise Generator

- 5 Hz to 5 MHz
- 30 μV to 3 V
- $\pm 1\text{-dB}$ audio-spectrum-level uniformity

This instrument generates wide-band noise of uniform spectrum level, particularly useful for noise and vibration testing in electrical and mechanical systems. The noise output of a gas-discharge tube is amplified and shaped with low-pass filters to provide wide spectral ranges with upper cutoff frequencies of 20 kHz, 500 kHz, and 5 MHz.

The output level is controlled by a continuous attenuator followed by a 4-step attenuator of 20 dB per step and is metered from over 3 volts to below 30 microvolts. When the attenuator is used, the output impedance remains essentially constant as you change the output level.

Frequency response Drive your device under test with the 1390-B and analyze output with any of several GR analyzers, manually or with a graphic level recorder. In contrast with the usual swept-single-frequency methods, this one makes your DUT handle a wide spectrum simultaneously. The distinction may be significant if the DUT is nonlinear.

Use the 1390-B as a broad-band signal source for:

- frequency response
- intermodulation and cross-talk tests
- simulation of telephone-line noise
- measurements on servo amplifiers
- noise interference tests on radar
- determining meter response characteristics
- setting transmission levels in communication circuits
- statistical demonstrations in classroom and lab

Make acoustic measurements:

- frequency response
- reverberation — use 1390-B with a GR analyzer as source of narrow-band noise
- sound attenuation of ducts, walls, panels, or floors
- acoustical properties of materials
- room acoustics

Use it with an amplifier to drive:

- a loudspeaker for structural fatigue tests in high-level acoustic fields
- a vibration shake-table

— For more information, request GR Reprint E-110.

SPECIFICATIONS

Frequency Range: 5 Hz to 5 MHz.

Output: VOLTAGE: Max open-circuit output is at least 3 V for 20-kHz range, 2 V for 500-kHz range, and 1 V for 5-MHz range.

IMPEDANCE: Source impedance for max output is approx 900 Ω . Output is taken from a 2500- Ω potentiometer. Source impedance for attenuated output is 200 Ω . One output terminal is grounded.

Spectrum: See spectrum-level curves and following table. Note: Spectrum level is shown with constant-Hz-bandwidth analysis, "white" noise being ideally flat. (Pink noise would slope down at 10 dB per decade.)

Range	Typical Spectrum Level (with 1-V rms output)	Spectrum Level Uniformity*
20 kHz	5 mV for 1-Hz band	within ± 1 dB, 20 Hz to 20 kHz
500 kHz	1.2 mV for 1-Hz band	within ± 3 dB, 20 Hz to 500 kHz
5 MHz	0.6 mV for 1 Hz band	within ± 3 dB, 20 Hz to 500 kHz within ± 8 dB, 500 kHz to 5 MHz

* Noise energy also beyond these limits. Level is down 3 dB at 5 Hz.



Typical spectrum-level characteristics.

Waveform: Noise source has good normal, or Gaussian, distribution of amplitudes for ranges of the frequency spectrum that are narrow compared with the band selected. Over wide ranges the distribution is less symmetrical because of dissymmetry introduced by the gas tube. Some clipping occurs on the 500-kHz and 5-MHz ranges.

Voltmeter: Rectifier-type averaging meter measures output. It is calibrated to read rms value of noise.

Attenuator: Multiplying factors of 1.0, 0.1, 0.01, 0.001, and 0.0001. Accurate to $\pm 3\%$ to 100 kHz, within $\pm 10\%$ to 5 MHz.

Available: Rack-adaptor set (19x7 in.); 1390-P2 PINK-NOISE FILTER.

Power: 105 to 125 or 210 to 250 V, 50 to 400 Hz, 50 W.

Mechanical: Convertible bench cabinet. DIMENSIONS (wx hxd): Bench, 12.75x7.5x9.75 in. (324x191x248 mm). WEIGHT: 12 lb (5.5 kg) net, 16 lb (7.5 kg) shipping.

Description	Catalog Number
1390-B Random-Noise Generator	
115-V Model	1390-9702
230-V Model	1390-9703
Rack Adaptor Set (7 in.)	0480-9842

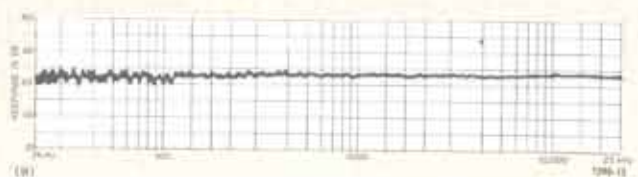
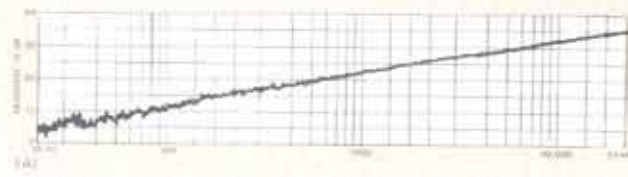

(A) Output (white noise) of the 1390-B Random-Noise Generator and (B) output (pink noise) after filtering by the 1390-P2 Pink-Noise Filter, as measured by a one-third-octave band analyzer.

1390-P2 Pink-Noise Filter

When white noise is used for frequency-response measurements in conjunction with a constant-percentage bandwidth analyzer (such as the GR 1564-A Sound and Vibration Analyzer or 1568-A Wave Analyzer), the amplitude-frequency characteristic of a flat system appears to slope upward with increasing frequency at a rate of 3 dB

per octave, owing to the constantly increasing bandwidth (in hertz) of the analyzer. The 1390-P2 converts the audio-frequency output of the 1390-B from white noise to pink noise, which has constant energy per octave. Thus it flattens the response curves made with a constant-percentage-bandwidth analyzer.

SPECIFICATIONS

Frequency Response: Sloping -3 dB per octave from 20 Hz to 20 kHz, -6 dB per octave above 20 kHz. Output voltage is approx -5 dB with respect to the input voltage at 20 Hz and -35 dB at 20 kHz. It lies within 1 dB of the straight line connecting these two points on a graph of output in decibels vs log frequency.

Over-all Output Level: When the filter is used with the random-noise generator set for the 20-kHz range, the output voltage of the filter is approx 30 dB below its input, and the voltage level in each one-third-octave band is approx 17 dB below that. Thus, when the output meter of the generator indicates 3 V, the output of the filter is approx 0.1 V, and the level in each one-third-octave band is approx 15 mV.

Input Impedance: The filter should be driven from a source whose impedance is 1 k Ω or less. Input impedance is variable

from 6.5 k Ω + load resistance at zero frequency to 6.7 k Ω at high frequencies.

Output Impedance: The filter should not be operated into a load of less than 20 k Ω . Internal output impedance is variable from 6.5 k Ω + source resistance at low frequencies to approx 200 Ω at high frequencies.

Max Input Voltage: 15 V rms.

Terminals: Input terminals are recessed banana pins on $\frac{3}{4}$ -in. spacing at rear of unit. Output terminals are jack-top binding posts with $\frac{3}{8}$ -in. spacing.

Mechanical: Plug-in unit housing. DIMENSIONS (wxhxd): 1.38x 5x2.87 in. (35x127x73 mm). WEIGHT: 6 oz (0.2 kg) net, 4 lb (1.9 kg) shipping.

Description	Catalog Number
1390-P2 Pink-Noise Filter	1390-9602

Ⓢ Federal stock numbers are listed before the index.



Bench model shown with 1522-P1 Preamp.

1522 DC Recorder

- 2-mV/inch and 0.2- μ A/inch sensitivity
- 50-inch/second writing speed
- 0.25% linearity, 0.5% accuracy
- programmable writing functions
- plug-in versatility: grounded or differential input

In the director's seat Imagine an automatic testing system that is programmed by its own analog recorder. As the output data are plotted, the recorder programs test conditions and measurement ranges, activates and synchronizes other recording devices, and controls its own writing functions. Triggered by timing marks printed on the chart paper, the GR 1522 DC Recorder will control companion instruments and itself, changing chart speed, rewinding the chart for overplotting, quickly advancing to a fresh graph, all the while remembering to lift the pen when not plotting. With optional limit switches, the 1522 can operate sort/select mechanisms, activate additional recorders, or alert an operator if the plotted data exceed preset high or low limits.

As an accessory to the GR 1921 Real-Time Analyzer, for example, the 1522 Recorder will plot the band levels against frequency much faster than conventional X-Y plotters. Operating synchronously with the 1921, the recorder pauses briefly as each band level is selected to allow the pen to settle, producing a neat bar graph with a standard scale factor.

The 1522 is a fine program director; it is first a superb dc recorder, combining accuracy, high sensitivity, and fast writing speed. It will plot a full-scale (5-inch) transient in < 100 ms, respond to a 200- μ V or 20-nA change with a 1-division deflection, and maintain linearity to within $\frac{1}{2}$ of a division (0.25%).

The recorder accepts one of two plug-in preamplifiers. The 1522-P1 Preamp provides a wide range of voltage and current measurements at an economical price. The 1522-P2 Differential Preamp provides the same versatility with the added feature of a differential input so that measurements from ungrounded sources can be made. This plug-in offers up to 180-dB of common-mode rejection at input levels up to ± 500 volts.

For your convenience A chart take-up reel is included, but the chart paper can feed directly out for immediate inspection and use. Controls are few and obvious; the pen, for instance, is lifted electrically by a manual switch and automatically when the chart is being positioned in either its fast-scan or slow-scan mode. For reliability, there are no gears or clutches; speed changes and con-

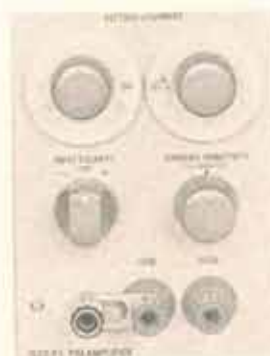

1522-P1 Preamp



1522-P2 Differential Preamp

trol of the stepping drive motor are all done with integrated circuits.

The pen in the 1522 is a fibre-plastic tipped, clog free, disposable marker. It never needs refilling and provides neat, highly readable, skip-free traces even at the fastest writing speeds. You have a choice of colors and a choice of marker types: the fastrak[®] Marker for general purposes and the Slow-Speed Marker for particularly slow-moving records or those with much retracing over a part of the chart.

— See **GR Experimenter** for May-June 1969 and January-February 1970.

SPECIFICATIONS

INPUT WITH 1522-P1 PREAMPLIFIER

Ranges: Controlled by range switches, polarity switch, and continuous control with calibrated position that operates on all ranges. DC VOLTAGE: 2 mV/in. to 100 V/in.; 15 ranges, 1-2-5 sequence. DC CURRENT: 0.2 μ A/in. to 100 mA/in.; 18 ranges, 1-2-5 sequence.

Accuracy: $\pm 0.5\%$ of full scale.

Linearity: $\pm 0.25\%$ of full scale, including recorder linearity.

Stability: $< 0.01\%$ /day drift typical in 0.2 V/in. range after warmup.

Input Isolation: > 1000 M Ω dc from LOW to GROUND terminal at 200 V max dc; 0.22 μ F ac. VOLTAGE: 200 V max dc or peak ac.

Common-Mode Rejection: 70 dB dc with 1-k Ω source impedance; 40 dB ac at 60 Hz.

Input Resistance: VOLTAGE: 1 M Ω . CURRENT: 1 Ω to 10 k Ω depending on scale as follows: (0.2 to 2 μ A/in.) 10 k Ω , (5 μ A/in.) 4 k Ω , (10 μ A/in.) 2 k Ω , (20 μ A/in.) 1 k Ω , (50 μ A/in.) 400 Ω , (100 μ A/in.) 200 Ω , (0.2 mA/in.) 100 Ω , (0.5 mA/in.) 40 Ω , (1 mA/in.) 20 Ω , (2 mA/in.) 10 Ω , (5 mA/in.) 4 Ω , (10 mA/in.) 2 Ω , (20 to 100 mA/in.) 1 Ω .

Offset and Drift: VOLTAGE: Adjustable to zero. DRIFT: ± 25 μ V/ $^{\circ}$ C from 0 to 50 $^{\circ}$ C after warmup; warmup drift < 0.5 mV. CURRENT (bias): 0.1 nA at 25 $^{\circ}$ C; doubles each rise of 11 $^{\circ}$ C.

INPUT WITH 1522-P2 DIFFERENTIAL PREAMPLIFIER

Frequency: -3 dB at 50 Hz (3rd order Butterworth response).

Ranges: Controlled by range switches, polarity switch, and continuous control with calibrated position that operates on all ranges. VOLTAGE: 2 mV/in. to 100 V/in.; 15 ranges, 1-2-5 sequence. CURRENT: 0.2 μ A/in. to 100 mA/in.; 18 ranges, 1-2-5 sequence.

Accuracy: $\pm 0.5\%$ of full scale when in calibrated position.

Linearity: $\pm 0.25\%$ of full scale, including recorder linearity.

Input Isolation: $\geq 10^9$ Ω from GUARD terminal to ground, in parallel with < 500 pF. VOLTAGE: 500 V dc or peak ac.

Common-Mode Rejection: 160 dB dc, 80 dB 60 Hz, undriven guard, typical; 180 dB ac up to 20 kHz, driven guard, typical.

Offset and Drift: VOLTAGE: Adjustable to zero. DRIFT: $\pm (25$ μ V/ $^{\circ}$ C + 0.005% of full scale/ $^{\circ}$ C) from 0 to 55 $^{\circ}$ C. CURRENT (bias): 0.1 nA at 25 $^{\circ}$ C; doubles each rise of 11 $^{\circ}$ C.

Input Resistance between HIGH and LOW terminals: VOLTAGE: 1 M Ω . CURRENT: 0.11 to 50 Ω depending on scale as follows: (0.2 μ A/in.) 50 Ω , (0.5 μ A/in.) 20 Ω , (1 μ A/in.) 10.1 Ω , (2 μ A/in.) 5.06 Ω , (5 μ A/in.) 2.06 Ω , (10 μ A/in.) 1.06 Ω , (20 μ A/in.) 0.56 Ω , (50 μ A/in.) 0.26 Ω , (100 μ A/in.) 0.16 Ω , (200 μ A/in.) 0.11 Ω , (0.5 mA/in.) 40 Ω , (1 mA/in.) 20 Ω , (2 mA/in.) 10 Ω , (5 mA/in.) 4 Ω , (10 mA/in.) 2 Ω , (20 to 100 mA/in.) 1 Ω .

RECORDER RESPONSE (with 2-in. excursion)

Fast Writing Speed: 50 in./s with $< 3\%$ overshoot.

Slow Writing Speeds: (See table)

Servo Bandwidth (3 dB, for $\frac{1}{4}$ -in. excursions): (See table)

Writing Speed:	50	30	20	10	5	2	1	0.5 in./s
Servo Bandwidth:	30	20	15	7.5	4	1.5	0.75	0.4 Hz

Linearity: $\pm 0.25\%$ of full scale.

Deadband: $\pm 0.15\%$ of full scale.

Zero Adjustment: 10-turn pot, can be set over full range.

Chart Speeds: 0.5, 1, 2, 5, 10, 20 seconds, minutes, hours per inch; 18 speeds. Chart moves in 0.0067-in. increments (0.26 mm) and can be started or stopped in one step.

Synchronization: Sync outputs permit other 1522 recorders to run at identical speed or at other standard speeds in synchronization with master recorder.

Programmability: All chart control functions fully programmable and outputs provided for full system integration. REMOTE-CONTROL FUNCTIONS: Require switch or solid-state closure to ground. Controls: pen lift and pen down; two event markers, all chart speeds; chart start, stop, forward, reverse; fast scan (2 in./s) with pen-lift; slow scan (2 in./min) with pen-lift; record command (drops pen, starts chart at selected

speed); servo blanking (pen motion stopped in any position). REMOTE-CONTROL OUTPUTS: Start, stop, forward, reverse, servo-position error (0 state for position error of $< 0.5\%$), retransmitting potentiometer, three independent solid-state closures corresponding to lines printed on paper; pen down; 300 pps sync and motor-speed sync selected by chart-speed controls.

Other Outputs: Power for two additional stepper motors, power for externally controlled dc reference voltage.

Supplied: 274-NQ 3-ft double-plug patch cord, fastrak[®] Marker Set of 12 assorted-color pens, Event-Marker Set of 4 red and 4 black pens, 2 chart-paper rolls type 1522-9640, 2 potentiometer contacts, 2 paper cap assemblies, power cord, 50 chart-mounting sheets.

Available: 1522-P11 Limit-Switch Set provides two adjustable limit stops; pen at limit closes reed-relay contacts with 50-V, 500-mA dc rating, 150-V breakdown rating.

Power: 100 to 125 or 200 to 250 V, 50-60 Hz, 90 W.

Mechanical: Bench or rack models. DIMENSIONS (wxhxd): Bench, 19.5x7x17 in. (496x178x432 mm); rack, 19x5.25x15.25 in. (483x133x387 mm). WEIGHT: Bench, 43 lb (20 kg) net, 58 lb (27 kg) shipping; rack, 39 lb (18 kg) net, 54 lb (25 kg) shipping; 1522-P1, 1.5 lb (0.7 kg) net, 8 lb (3.7 kg) shipping; 1522-P2, 3.25 lb (1.5 kg) net, 10 lb (4.6 kg) shipping.

Description	Catalog Number
1522 DC Recorder, less preamplifier	
Bench Model	1522-9700
Rack Model	1522-9701
Select one or both of following essentials	
1522-P1 Preamplifier	1522-9601
1522-P2 Differential Preamplifier	1522-9602
Accessories available	
1522-P11 Limit-Switch Set, for 2 adjustable limit stops	1522-9611
Extender Board Kit, for servicing ease	1522-9613
Cable Set, for connection to 1921	1522-9670
Event-Marker Set, 4 black, 4 red pens	1522-9612
Mounting Sheets, 8 $\frac{1}{2}$ x 11 in. sheets with adhesive strips to mount charts for filing in 3-ring notebooks; 50 charts per pack	1522-9639
fastrak[®] Marker Sets (general purpose)	
Set of 4 RED pens	1522-9614
Set of 4 GREEN pens	1522-9615
Set of 4 BLUE pens	1522-9616
Slow-Speed Marker Sets	
Set of 4 RED pens	1522-9634
Set of 4 GREEN pens	1522-9635
Set of 4 BLUE pens	1522-9636
Chart Paper, 140-ft rolls (43 m)	

FOR GENERAL PURPOSES and 1921

Ideal for use with 1921 Real-Time Analyzer, 25-dB/decade scale factors, inch-ruled charts have 2.08-in/decade abscissas, centimeter-ruled charts have 5-cm/decade abscissas. Bands are ANSI preferred 1 $\frac{1}{2}$ -octave.

* Ordinate Scale	Bands	Abscissa Frequencies	Catalog Number
*Linear	Linear, 5 div/in.		1522-9640
*Linear	Linear, 4 div/in., right control marks $\frac{1}{4}$ in. apart, left marks 10 in. apart.		1522-9650
*Linear	Linear, 2 div/in., right control marks, $\frac{1}{2}$ in. apart, left marks 10 in. apart.		1522-9651
*10dB/in.	30 bands — not marked		1522-9647
12dB/in.	30 bands — not marked		1522-9646
12dB/in.	5-34	3.15 Hz-2.5 kHz	1522-9652
12dB/in.	5-49	3.15 Hz-80 kHz	1522-9648
12dB/in.	11-40	12.59 Hz-10 kHz	1522-9645
12dB/in.	14-43	25 Hz-20 kHz	1522-9644
5dB/cm	30 bands — not marked		1522-9658
5dB/cm	5-34	3.15 Hz-2.5 kHz	1522-9656
5dB/cm	5-49	3.15 Hz-80 kHz	1522-9654
5dB/cm	11-40	12.59 Hz-10 kHz	1522-9657
5dB/cm	14-43	25 Hz-20 kHz	1522-9655

FOR T/D 1923 ANALYZER SYSTEMS
Has 5.67x5.0-in. areas linearly divided, repeated every 11 in. Ordinate and abscissa graduations every 0.125 in. (3.18 mm); 5th lines accented.

1522-9680

* Total ordinate range is 60 dB, except for -9647 which is 50 dB and for linear charts which are 50 div. Charts with control marks take advantage of the automatic programming feature of the 1522.



1566 Multichannel Amplifier

- 16 channels
- manual or remote channel selection
- 2-Hz to 100-kHz response
- 55-dB gain, manually or remotely adjusted
- calibration noise source built in

Many inputs — one output Many sound and vibration measurements can be simplified by use of a scanner that connects, in sequence or in any arbitrary order, the outputs from a number of transducers to a single analyzer. A scanner system can be set up to measure signals individually or to average all signals.

The 1566 scans up to 16 channels (up to 99 with a special additional unit), amplifies each by up to 55 dB, and provides a built-in pink-noise calibration source that speeds not only the check out of the scanner but also that of any analyzer connected to it. The 1566 is particularly useful with the 1921 Real-Time Analyzer. This combination can automatically analyze the spectrum from each transducer scanned or it can measure the space-averaged spectrum using 2, 4, 8, 10, 12, or 16 microphones. This feature makes possible automatic real-time sound-power measurements.

SPECIFICATIONS

Channels: 16 plus 1 for calibration, expandable to 99 (additional channels housed in a special unit). **CONTROL:** Active channel is selected manually or by external 1-2-4-8 BCD signal, or automatically scanned in sequence with range of channels to be scanned selected by thumbwheel switches; dwell time adjustable from 100 ms to 10 s or infinity (channel advance initiated by external signals); scan set to occur once or repetitively and started, stopped on active channel, or reset to lowest channel by pushbuttons or external closures to ground.

DISPLAY: Two high-intensity neon readout tubes display active channel number.

Frequency: 2 Hz to 100 kHz, flat within ± 0.5 dB.

Sensitivity: 1.8 mV to 1.6 V for 1-V output; gain set in 1-dB increments by panel control or 1-2-4-8 BCD signal at standard DTL levels (logic 0 = ground, logic 1 $\geq +3.5$ V). Rear-panel adjustment provides 10-dB continuous control of gain for all channels for calibration. Each channel includes a 6-dB gain adjustment for transducer sensitivity equalization.

Maximum Input: 5 V rms, 7 V pk.

Impedance: INPUT, 100 Ω . OUTPUT, 600 Ω .

Noise: <10 μ V equivalent input noise (C weighted) in each channel when gain is maximum and source impedance is ≤ 100 Ω .

Cross-Talk: Interchannel isolation >90 dB.

Calibration: Built-in pink-noise (± 1 dB) source with symmetrical Gaussian distribution from 2 Hz to 100 kHz. Spectrum-level slope is -3 dB per octave. Noise signal applied to internal calibration channel is adjustable from 30 to 100 mV rms. Rear-panel noise output is fixed at 100 mV rms and can be loaded by 0.05 μ F without affecting spectrum up to 100 kHz.

Supplied: Power cord, two 24-pin data plugs.

Available: 1566-P40 and -P42 PREAMPLIFIERS (1566 provides power for up to 99 of either), 1566-9500 CABLE SET for connection to 1921 Real-Time Analyzer, microphones, vibration pickups.

Power: 100 to 125 or 200 to 250 V, 50 to 60 Hz, 30 W.

Mechanical: Bench or rack models. **DIMENSIONS (wxhxd):** Bench, 19.5x5x20 in. (495x127x508 mm); rack, 19x3.5x18.5 in. (483x89x470 mm). **WEIGHT:** Bench, 32 lb (15 kg) net, 47 lb (22 kg) shipping; rack, 26 lb (12 kg) net, 41 lb (19 kg) shipping.

Description	Catalog Number
1566 Multichannel Amplifier	
Bench Model	1566-9700
Rack Model	1566-9701
Cable Set	1566-9500



1569 Automatic Level Regulator

- 2 Hz to 100 kHz
- 50-dB control range
- acoustic-system component

Constant level Use this regulator to hold a monitored signal amplitude steady (such as the sound level in a test chamber) while you sweep the frequency or some other parameter. The primary use is to control the excitation level in swept-frequency sound and vibration testing. The 1569 functions as an automatically controlled amplifier/attenuator between the oscillator and the power-amplifier-transducer chain.

The regulator senses a control voltage from a microphone, accelerometer, or other pickup monitoring the quantity to be controlled and adjusts its own attenuation to maintain that control voltage at constant level. Output from the 1569 is indicated on a panel meter with a scale that is linear in dB, showing you where the regulator is operating in its 50-dB control range. You can easily adjust the control rate to suit operating frequency and magnitude-phase relationships in your control loop.

In an entirely different mode of operation, the 1569 can be used to provide a leveled output, when driven by a poorly leveled signal source. In this mode, the control range is limited to the acceptable range for signal-input levels in the regulator, about 15 dB, whereas the range of outputs is much larger.

— See *GR Experimenter* for April, 1968.

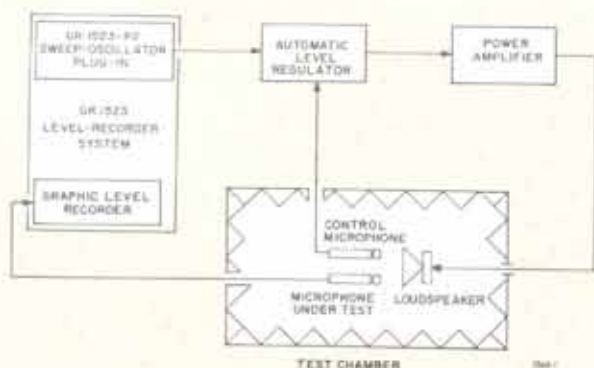

Typical measurement system using 1569.

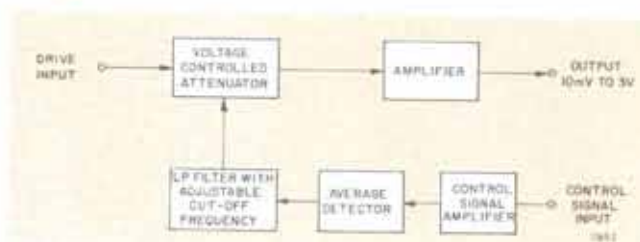

Diagram of 1569 Automatic Level Regulator.

SPECIFICATIONS

Operating Ranges: FREQUENCY: 2 Hz to 100 kHz. CONTROL RANGE: 50 dB. COMPRESSION RATIO: 25, i.e., 0.04 dB per dB.

Main Input: DRIVE VOLTAGE REQUIRED: For normal operation, 1 V; in voltage-leveler mode, 0.2 to 1 V. IMPEDANCE: 100 k Ω .

Output: VOLTAGE: 10 mV to 3 V. IMPEDANCE: 600 Ω . LOAD: Any impedance can be connected without affecting linear operation of output circuit.

Quality: NOISE LEVEL: Typically better than 65 dB below 3-V output in 100-kHz bandwidth. HARMONIC DISTORTION: <1% total for output levels <1 V.

Automatic Shut-Down Function: If drive input level drops below a critical voltage, output automatically drops to zero, to protect equipment connected to it.

Control-Signal Input: VOLTAGE: 5 mV to 4 V, required. IMPEDANCE: 25 M Ω .

Control Rates and Corresponding Min Operating Frequencies:

1000 dB/s	300 dB/s	100 dB/s	30 dB/s	10 dB/s	3 dB/s
600 Hz	200 Hz	60 Hz	20 Hz	6 Hz	2 Hz

Power: 100 to 125 or 200 to 250 V (switch selected), 50 to 60 Hz, 4 W.

Supplied: Power cord, mounting hardware with rack or bench models.

Available: 1560-P42 PREAMPLIFIER. Note: Power for preamp is available at rear-panel input connector. 1523 GRAPHIC LEVEL RECORDER with 1523-P2 Sweep Oscillator Plug-in. Microphones and vibration pickups.

Mechanical: Rack-bench cabinet. DIMENSIONS (wxhxd): Bench, 19x5x12.87 in. (483x127x327 mm); rack, 19x3.5x12.75 in. (483x89x324 mm). WEIGHT: 13 lb (6 kg) net, 30 lb (14 kg) shipping.

Description	Catalog Number
1569 Automatic Level Regulator	
Bench Model	1569-9700
Rack Model	1569-9701



1840-A Output Power Meter

- 20 Hz to 20 kHz
- 0.1 mW to 20 W
- 0.6- Ω to 32-k Ω input impedance
- true rms reading

The 1840-A measures audio-frequency power into any desired magnitude of load impedance. Its important uses include the measurement of:

- Power output of oscillators, amplifiers, preamplifiers, transformers, transducers, and low-frequency lines.
- Output impedance, by adjustment of this load to yield maximum power indication.
- Frequency-response characteristics of amplifiers, transformers, and other audio-frequency devices.

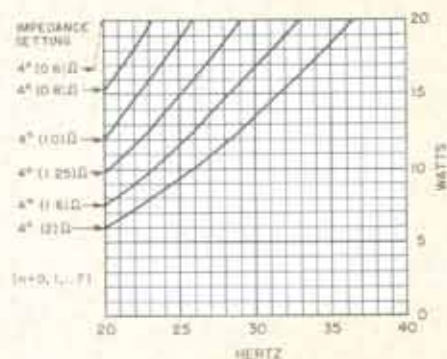

Power derating vs impedance setting and frequency. All 48 impedance settings are represented, as $n = 0, 1, 2, \dots, 7$.

This instrument is basically a multi-tapped audio-frequency transformer with a fixed secondary load. Its two front-panel switches connect eight identical primary windings and six secondary taps in various combinations to provide a total of 48 different primary impedances.

The maximum power rating can be extended for any given impedance with the use of a simple T-network attenuator, design data for which are supplied with the instrument.

SPECIFICATIONS

Power: 0.1 mW to 20 W, 40 Hz to 20 kHz. Below 40 Hz, max rating is reduced by up to 50% (at 25 Hz), depending on impedance selected. See curve. Auxiliary dB scale reads from -15 to +43 dB re 1 mW.

Impedance: 0.6 Ω to 32 k Ω in two ranges; yielding 48 individual impedances spaced approximately $\sqrt[2]{2}$ apart.

Power Accuracy:

- At 1 kHz, ± 0.3 dB;
- 50 Hz to 6 kHz, ± 0.5 dB;
- 30 Hz to 10 kHz, ± 1 dB;
- at 20 Hz, -1.5 dB max, -1 dB avg;
- at 20 kHz, -5 dB max, ± 1.5 dB avg.

Impedance Accuracy (at full-scale voltage):

- At 1 kHz, $\pm 6\%$ max, -0.5% avg;
- 70 Hz to 2.5 kHz, $\pm 7\%$;
- 2.5 kHz to 5 kHz, for $Z < 10$ k Ω , $\pm 7\%$;
- at 20 Hz, -15% max, -8% avg;
- at 20 kHz, $\pm 50\%$ max, $\pm 12\%$ avg.

Waveform Error: Meter will indicate true rms with as much as 20% second and third harmonics present in the input signal.

Mechanical: Convertible bench cabinet. DIMENSIONS (wx hxd): 12x4x8 in. (305x102x203 mm). WEIGHT: 11 lb (5 kg) net, 17 lb (8 kg) shipping. Rack-adaptor panel height, 3.5 in. (89 mm).

Description	Catalog Number
1840-A Output Power Meter *	1840-9701
480-P212 Relay-Rack Adaptor Set	0480-9822

* Federal stock numbers are listed before the Index.

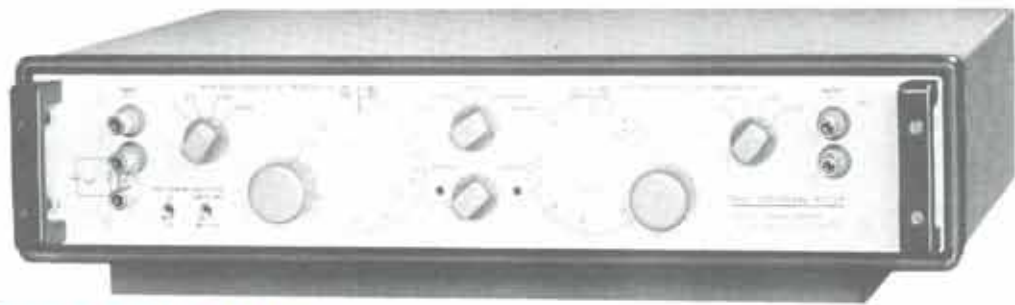

1952 Universal Filter

- 4-Hz to 60-kHz tuning
- low-pass or high-pass, band-pass or band-reject, ganged for easy tuning
- high attenuation rate—30 dB/octave
- line or battery operation

The 1952 Universal Filter will perform as a low-pass, high-pass, band-pass, or band-reject filter at the turn of a panel switch. It consists of low-pass and high-pass filters that can be employed singly, in cascade, or in parallel, to provide the assortment of over-all characteristics. The cut-off frequencies of the two filters can be controlled independently or ganged together to provide constant-percentage bandwidth for band-pass or band-reject tuning.

This filter is of value in many signal-conditioning applications. For example, it can be used to control system bandwidth for reduction of extraneous signals or to evaluate the effect of limited bandwidth upon signal intelligibility and data-transmission accuracy. As a high-pass filter it can reduce power-line-related components, as a low-pass filter control high-frequency noise, or as a notch filter eliminate single-frequency components. The 1952 can also act as part of a spectrum analyzer or distortion meter and, with a random-noise generator, produce controlled bands of noise as test signals.

— See *GR Experimenter* for April 1968.

SPECIFICATIONS

Frequency Range: CUT-OFF FREQUENCIES: Adjustable 4 Hz to 60 kHz in four ranges. **PASS-BAND LIMITS:** Low-frequency response to dc (approx 0.7 Hz with ac input coupling) in Low Pass and Band Reject modes. High-frequency response uniform ± 0.2 dB to 300 kHz in High Pass and Band Reject modes. **CONTROLS:** Log frequency-dial calibration; accuracy $\pm 2\%$ of cut-off frequency (at 3-dB points).

Filters: **FILTER CHARACTERISTICS:** Filters are fourth-order (four-pole) Chebyshev approximations to ideal magnitude response. The nominal pass-band ripple is ± 0.1 dB (± 0.2 dB max); nominal attenuation at the calibrated cut-off frequency is 3 dB; initial attenuation rate is 30 dB per octave. Attenuation at twice or at one-half the selected frequency, as applicable, is at least 30 dB. **TUNING MODES:** Switch selected, Low Pass, High Pass, Band Pass, and Band Reject. **GANGED TUNING:** The two frequency controls can be ganged in Band Pass and Band Reject modes so the ratio of upper to lower cut-off frequencies remains constant as controls are adjusted. Range overlap is sufficient to permit tuning through successive ranges without the need to reset frequency controls if ratio of upper to lower cut-off frequencies is 1.5 or less. **MINIMUM BANDWIDTH:** 26% (approx $\frac{1}{2}$ octave) in Band Pass mode. **NULL TUNING:** In Band Reject mode, setting the frequency controls for a critical ratio of upper to lower cut-off frequency (indicated on dials) gives a null characteristic

(point of infinite attenuation) that can be tuned from 5 Hz to 50 kHz.

Input: **GAIN:** 0 or -20 dB, switch selected. **IMPEDANCE:** 100 k Ω . **COUPLING:** Ac or dc, switch selected. Lower cut-off frequency (3 dB down) for ac coupling is about 0.7 Hz. An LC filter at input limits bandwidth to 300 kHz, thus reducing danger of overloading active circuits at frequencies above normal operating range.

Max Input Voltage: **SINE WAVE:** 3 V rms (8.5 V pk-pk); except with input attenuator at 20 dB, 30 V rms. **DC COUPLED:** ± 4.2 V pk. **AC COUPLED:** Max peak level of ac component must not exceed ± 4.2 V for specified performance; dc level, ± 100 V. Peaks up to ± 100 V are tolerated without damage.

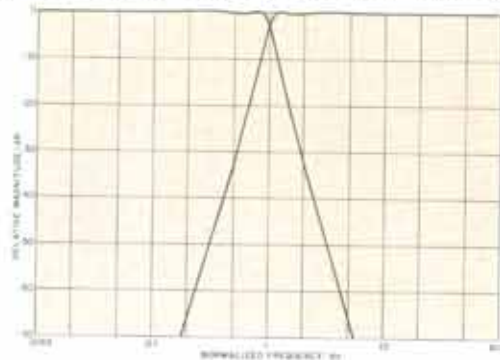

Low-pass and high-pass filter characteristics.

Output: **IMPEDANCE:** 600 Ω . **LOAD:** Any load can be connected without affecting linear operation of output circuit. **TEMPERATURE COEFFICIENT** of output offset voltage: Between 0 and $+4$ mV/ $^{\circ}$ C.

Noise: <100 μ V in an effective bandwidth of 50 kHz.

Distortion: Max harmonic distortion, with all components in the pass band, for a linear load, is less than 0.25% for open-circuit voltages up to 3 V and frequencies up to 50 kHz.

Available: Rechargeable batteries (two required) and 1560-P60 Battery Charger. Replacement battery: Gould 9.6V/225B with snaps, or equivalent.

Power: 100 to 125 or 200 to 250 V (switch selected), 50 to 60 Hz, 2.5 W. Or 19.2 V, approx 20 mA from rechargeable nickel-cadmium batteries (not supplied), about 10-h operation. Connections for external battery.

Mechanical: Bench or rack models. **DIMENSIONS (wxhxd):** Bench, 19x3.87x14.8 in. (483x98x376 mm); rack, 19x3.5x13.63 in. (483x89x346 mm); charger, 4.25x3.75x8 in. (108x95x203 mm). **WEIGHT:** 21 lb (10 kg) net, 25 lb (12 kg) shipping.

Description	Catalog Number
1952 Universal Filter	
Bench Model	1952-9801
Rack Model	1952-9811
Rechargeable Battery (2 req'd)	8410-1040
1560-P60 Battery Charger	
115 volts	1560-9660
230 volts	1560-9661

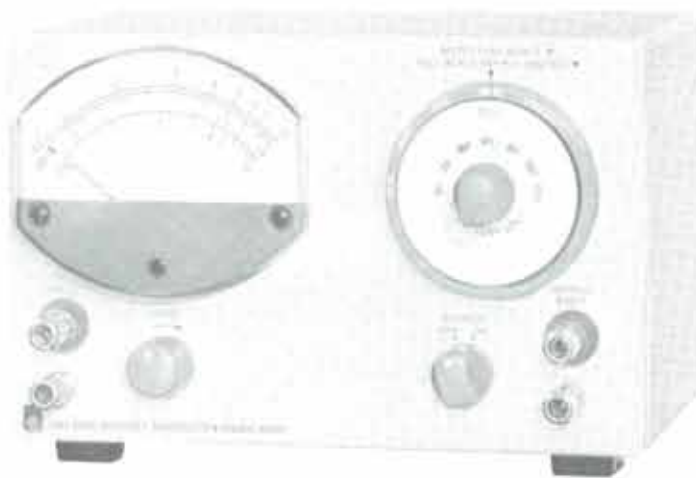

1346 Audio-Frequency Microvolter*

- self-contained dc source
1 μ V to 10 V
- calibrated ac attenuator to 100 kHz
0.1 μ V to 10 V
- use with any waveform

The GR 1346 Audio-Frequency Microvolter is a metered, calibrated attenuator that can be used as a self-contained low-level dc source and, in conjunction with an appropriate oscillator, as a source of from 0.1 μ V to 10 V of any ac waveform with a spectrum up to 100 kHz.

The input to the 1346 can be a dc voltage from the instrument's internal battery or from an external dc or ac source. An input attenuator, called the level control, provides continuous control of the voltage, which is applied to a 20-dB-per-step output attenuator. A total of 140-dB attenuation is provided by the two controls. The meter, in ac operation, is average responding, calibrated in rms volts and in dBm.

An on-off switch reduces the output to zero without disturbing other controls or shorting the output; the source impedance remains 600 Ω . This is convenient,

especially at very low levels, where shielding must be maintained. The zero-volt condition is useful in incremental dc-gain measurements and in locating noise sources and ground loops in critical low-level measurements.

The 1346 is entirely free from the power line and need not be grounded. The Microvolter* is therefore permitted to "float" in a test setup, so you can add the calibrated output to another signal. Front-panel terminals are gold-plated-copper binding posts for low thermal emf.

—See **GR Experimenter** for August-September 1968.

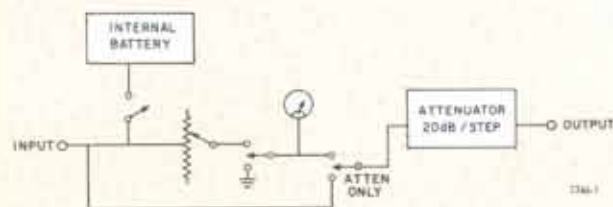

Microvolter controls permit continuous and step output control, zero-volt 600- Ω output, and bypassing of meter and continuous level control for operation as step attenuator only.

SPECIFICATIONS

Function	10 V ac	1 V ac	+10 V dc	-10 V dc	Atten Only
Open-Circuit Output Voltage Range	1.0 μ V to 10 V ac	0.1 μ V to 1.0 V ac	1.0 μ V to 10 V dc		0 to -120 dB, 20 dB/step
Accuracy at 23°C (above 10% of dc full scale)	$\pm(4\% + 0.2 \mu$ V)	$\pm(4\% + 0.02 \mu$ V)	$\pm(3\% + 0.2 \mu$ V)		$\pm(0.04$ dB/step +154 dB below input level) dc to 100 kHz
Source	External ac required 10.0 V into 595 Ω 1.0 V into 550 Ω		Internal battery or ext dc source 10 V max		Ext ac or dc source: 10 V max input
Input Impedance (approx) †	595 Ω to 25 k Ω	550 Ω to 25 k Ω	610 Ω to 25 k Ω , int battery removed		550 Ω to 5 k Ω

† Varies with setting of input level control, step attenuator, and load. Can be adjusted to remain constant with step-attenuator changes for load impedance of ≥ 50 ohms.

Distortion (at 1 kHz): <0.01% in 1-V-ac mode, <0.05% in 10-V-ac mode, with level control at max setting.

Output Impedance: 600 Ω \pm 0.5%.

Supplied: Battery, mounting hardware with rack model.

Available: GR 1309 and 1310 Oscillators, 1396 Tone-Burst Generator, 1381, 1382, and 1383 Random-Noise Generators.

Power: None required for 10-V-ac range. In other modes, 12-V dry battery: Eveready 228, RCA VS329, or Burgess PM8. Approx life, 33 hours at 2h/day in either dc mode, 316 hours at 2h/day in 1-V-ac mode.

Mechanical: Convertible-bench cabinet. DIMENSIONS (wxhx d): Bench, 8.5x5.41x7.44 in. (216x137x189 mm); rack, 19x 5.22x7.56 in. (483x133x192 mm). WEIGHT: Bench, 5 lb (2.3 kg) net, 7 lb (3.2 kg) shipping; rack, 8 lb (3.7 kg) net, 10 lb (4.6 kg) shipping.

Description	Catalog Number
1346 Audio-Frequency Microvolter*	
Bench Model	1346-9700
Rack Model	1346-9701
Replacement Battery	8410-1380

* Trademark registered in USA.

Sound-and-Vibration Measuring Accessories

Microphones

The microphones and microphone sets described on these pages will fulfill virtually any acoustic application. The microphones, when combined with the appropriate preamplifiers, adaptors, cables and other accessories, make complete microphone systems that may be used directly with GR equipment or with instrumentation from other manufacturers. Three basic types of microphones are offered.

Electret-Condenser These microphones represent the very latest in microphone technology. They feature very uniform high-frequency performance in both flat random- and flat perpendicular-incidence versions, are available in a variety of sizes, and are economically priced. Since polarization voltage is not required, they can be used with inexpensive preampli-

fiers such as the 1972-9600 described in the Preamplifier part of this section.

Ceramic Ceramic microphones are noted for their ruggedness, stability and reliability. Their low impedance and stable output contribute to their good performance under adverse environmental conditions.

Condenser Air-condenser microphones feature uniform high-frequency response and are suitable for operation at temperature extremes. They are available in various sizes. Because a polarization voltage is required for these microphones, they are sold only in microphone/preamplifier sets.

For information on how to select a microphone system to meet your specific needs, refer to **Guide to Microphone System Selection**, at the end of this section.

Electret-Condenser Microphones

1961 1-inch Electret-Condenser Microphones



New Since
Catalog U

Frequency: Curves show typical response and guaranteed limits; individual response curve supplied with each microphone. Below 20 Hz, the microphone is typically flat ± 1 dB down to 5 Hz. Microphone is essentially omnidirectional.

Sensitivity Level: NOMINAL: -36 dB re 1 V/N/m^2 (-56 dB re $1 \text{ V}/\mu\text{bar}$). TEMPERATURE COEFFICIENT: $+0.03$ dB/ $^{\circ}\text{C}$ from 0 to $+55^{\circ}\text{C}$. MAXIMUM SOUND-PRESSURE LEVEL: 160 dB absolute max.

Impedance: 100 ± 10 pF at 25°C and 1 kHz, temperature coefficient $< +0.1$ pF/ $^{\circ}\text{C}$ at 1 kHz.

Environment: -20 to $+55^{\circ}\text{C}$ and 90% RH operating; 1-year exposure in an environment of $+55^{\circ}\text{C}$ and 90% RH causes negligible sensitivity change.

Vibration Sensitivity: 83 dB equivalent SPL from 1 g (perpendicular to diaphragm) at 20 and 100 Hz.

Mechanical: TERMINALS: Coaxial, with 0.907-60 thread, adapted to 0.460-60 (threads per in.). DIMENSIONS: 0.936 ± 0.001 in. dia x 1.045 ± 0.001 in. long (1.435 ± 0.007 in. long with adaptor) (23.77 ± 0.025 x 26.55 ± 0.025 mm). WEIGHT: 1 oz (28 g) net, 1 lb (0.5 kg) shipping.

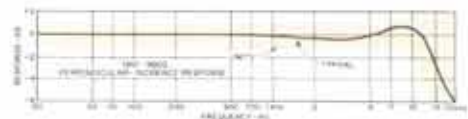
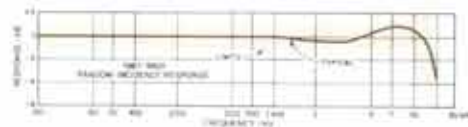

Typical Performance
with 1560-P42 and 1972-9600 Preamplifiers (Unity Gain)

Microphone	Frequency Range	"System" Sensitivity re 1 V/N/m^2	Dynamic Range* re $20 \mu\text{N/m}^2$
1961-9601	5 Hz to 12 kHz	-36 dB	18 to 140 dB
1961-9602	5 Hz to 15 kHz	-36 dB	18 to 140 dB

* A-weighted noise level to maximum rms sinewave signal without clipping.

Description	Catalog Number
1961 Electret-Condenser Microphones	
Flat random-incidence response, 1-inch	1961-9601
Flat perpendicular-incidence response, 1-inch	1961-9602

1962 1/2-inch Electret-Condenser Microphones



New Since
Catalog U

Frequency: Curves show typical response and guaranteed limits; individual response curve supplied with each microphone. Below 20 Hz, the microphone is typically flat ± 1 dB down to 5 Hz. Microphone is essentially omnidirectional.

Sensitivity Level: NOMINAL: -42 dB re 1 V/N/m² (-62 dB re 1 V/ μ bar). TEMPERATURE COEFFICIENT: $\sim +0.03$ dB/ $^{\circ}$ C from 0 to $+55^{\circ}$ C. MAXIMUM SOUND-PRESSURE LEVEL: 170 dB absolute max.

Impedance: 35 ± 5 pF, at 25° C and 1 kHz; temperature coefficient $< +0.04$ pF/ $^{\circ}$ C at 1 kHz.

Environment: -20 to $+55^{\circ}$ C and 90% RH operating; 1-year exposure in an environment of $+55^{\circ}$ C and 90% RH causes negligible sensitivity change.

Vibration Sensitivity: 83 dB equivalent SPL from 1 g (perpendicular to diaphragm) at 20 and 100 Hz.

Mechanical: TERMINALS: Coaxial, with 0.460-60 thread. DIMENSIONS: 0.500 ± 0.0005 in. dia x 0.815 ± 0.001 in. long (12.70 ± 0.0127 x 20.70 ± 0.025 mm). WEIGHT: 0.5 oz (14 g) net, 1 lb (0.5 kg) shipping.

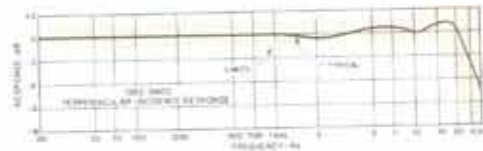
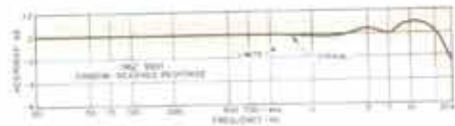

Typical performance

with 1560-P42 and 1972-9600 Preamplifiers (Unity Gain)

Microphone	Frequency Range	"System" Sensitivity re 1 V/N/m ²	Dynamic Range* re 20 μ N/m ²
1962-9601	5 Hz to 19 kHz	-43 dB	29 to 145 dB
1962-9602	5 Hz to 24 kHz	-43 dB	29 to 145 dB

* A-weighted noise level to maximum rms sinewave signal without clipping.

Description	Catalog Number
1962 Electret Condenser Microphones	
Flat random-incidence response, 1/2-inch	1962-9601
Flat perpendicular-incidence response, 1/2-inch	1962-9602

1963 1/4-inch Electret-Condenser Microphone



New Since
Catalog U

Frequency: Curve shows typical response and guaranteed limits; individual response curve supplied with each microphone. Below 20 Hz, the microphone is typically flat ± 1 dB down to 5 Hz. Response is essentially omnidirectional.

Sensitivity Level: NOMINAL: -55 dB re 1 V/N/m² (-76 dB re 1 V/ μ bar). TEMPERATURE COEFFICIENT: $\sim +0.03$ dB/ $^{\circ}$ C from 0 to $+55^{\circ}$ C. MAXIMUM SOUND-PRESSURE LEVEL: 170 dB absolute max.

Impedance: 12 ± 1 pF, at 25° C and 1 kHz; temperature coefficient $< +0.02$ pF/ $^{\circ}$ C at 1 kHz.

Environment: -20 to $+55^{\circ}$ C and 90% RH operating; 1-year exposure in an environment of $+55^{\circ}$ C and 90% RH causes negligible sensitivity change.

Vibration Sensitivity: 83 dB equivalent SPL from 1 g (perpendicular to diaphragm) at 20 and 100 Hz.

Mechanical: TERMINALS: Coaxial, with 0.224-60 thread, adapted to 0.460-60 (threads per in.). DIMENSIONS: 0.250 ± 0.0005 in. dia (6.35 ± 0.0127 mm). WEIGHT: 0.25 oz (7 g) net, 1 lb (0.5 kg) shipping.

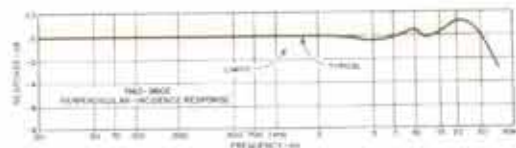

Typical performance

with 1560-P42 and 1972-9600 Preamplifiers (Unity Gain)

Microphone	Frequency Range	"System" Sensitivity re 1 V/N/m ²	Dynamic Range* re 20 μ N/m ²
1963-9602	20 Hz to 35 kHz	-58 dB	49 to 150 dB

* A-weighted noise level to maximum rms sinewave signal without clipping.

1963 Electret-Condenser Microphone		1963-9602
Flat perpendicular-incidence response, 1/4-inch		

Ceramic Microphones

1-inch Ceramic Microphones



Three versions of the 1-inch ceramic microphone are offered; the differences are described below. All versions use the same microphone cartridge.

The 1560-P5 microphone comes with an adaptor base that plugs into a female three-terminal microphone connector. It mates directly with 1560-P73 and 1560-P73B cables and can be mounted on a tripod in applications where the microphone will be remote from the instrument and no preamplifier is used.

The 1560-9570 comes with an adaptor that permits it to be mounted directly on the 1560-P42 or 1972-9600 preamplifiers.

The 1560-P6 microphone comes mounted on a flexible conduit that terminates in a three-terminal microphone connector. It is normally used with instruments such as the 1564 and 1934 to position the microphone away from the instrument case.

Frequency: Curve shows typical response and guaranteed limits; individual response curve supplied with each microphone. Below 20 Hz, the microphone is typically flat ± 1 dB down to 5 Hz. Time constant of pressure-equalizing leak is typically 0.08 s.

Sensitivity Level: NOMINAL: -40 dB re 1 V/N/m² (-60 dB re 1 V/ μ bar); MINIMUM: -42 dB re 1 V/N/m² (-62 dB re 1 V/ μ bar). TEMPERATURE COEFFICIENT: -0.01 dB/ $^{\circ}$ C. KEY SOUND-PRESSURE LEVELS: $<1\%$ distortion at 150 dB; at -184 and $+174$ dB peak, microphone may fail.

Impedance: For 1560-9605 and -9570 , 385 pF $\pm 15\%$ at 23° C; for 1560-9606, 405 pF $\pm 15\%$ at 23° C. TEMPERATURE COEFFICIENT of Z, for both: 2.2 pF/ $^{\circ}$ C from 0 to 50° C.

Environment: TEMPERATURE: -40 to $+60^{\circ}$ C operating. HUMIDITY: 0 to 100% RH operating.

Mechanical: TERMINALS, 3-pin mike connector; microphone cartridge has two terminals plus the shell; both terminals can be floated with respect to ground. DIMENSIONS: Cartridge only, 1.13 in. (29 mm) long, $0.936 \pm .002$ in. (23.7 mm ± 50 μ m) dia; 1560-P5 assembly, 2.31 in. (59 mm) long, 0.94 in. (24 mm) dia; 1560-P6 assembly, 11.75 in. (298 mm) long, 0.94 in. (24 mm) dia. WEIGHT: 1560-P5, 0.2 lb (0.1 kg)

1972 1/2-inch Ceramic Microphone



New Since
Catalog U

Frequency: Curve shows typical response and guaranteed limits; individual response curve supplied with each microphone. Below 20 Hz, the microphone is typically flat ± 1 dB down to 5 Hz. Time constant of pressure-equalizing leak is 0.08 s typical.

Sensitivity Level: NOMINAL: -60 dB re 1 V/N/m² (-80 dB re 1 V/ μ bar); MINIMUM: -65 dB re 1 V/N/m² (-85 dB re 1 V/ μ bar); TEMPERATURE COEFFICIENT: -0.01 dB/ $^{\circ}$ C. KEY SOUND-PRESSURE LEVELS: 165 dB with $<1\%$ distortion; at $+184$ and -190 dB peak, microphone may fail.

Impedance: 395 pF $\pm 15\%$ at 23° C. TEMPERATURE COEFFICIENT: 2.2 pF/ $^{\circ}$ C from 0 to 50° C.

Environment: TEMPERATURE: -40 to $+60^{\circ}$ C operating. HUMIDITY: 0 to 100% RH operating.

Mechanical: TERMINALS: Coaxial with $0.460-60$ thread for preamplifier mounting. DIMENSIONS: 0.5 in. dia x 0.78 in.

net, 1 lb (0.5 kg) shipping; 1560-P6, 0.7 lb (0.3 kg) net, 2 lb (0.9 kg) shipping.

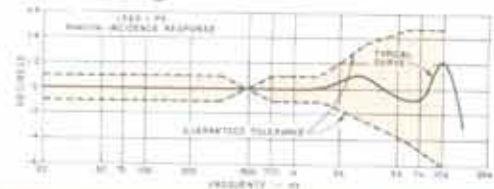

Typical performance of the 1560-9570 Microphone with the 1560-P42 and 1972-9600 Preamplifiers (Unity Gain)

Frequency Range	"System" Sensitivity re 1 V/N/m ²	Dynamic Range* re 20 μ N/m ²
5 Hz to 12.5 kHz	-40 dB	22 to 145 dB

* A-weighted noise level to maximum rms sinewave signal without clipping.

Description	Catalog Number
1-inch Ceramic Microphone	
1560-P5, with adaptor to mike connector	1560-9605
With adaptor to preamplifier	1560-9570
1560-P6, assembled with flexible conduit	1560-9606

long (13×20 mm). WEIGHT: 0.5 oz (14 g) net, 0.5 lb (0.3 kg) shipping.

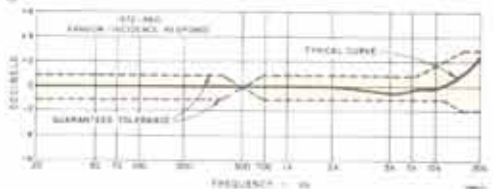

Typical performance with 1562-P42 and 1972-9600 Preamplifiers (Unity Gain)

Frequency Range	"System" Sensitivity re 1 V/N/m ²	Dynamic Range* re 20 μ N/m ²
5 Hz to 20 kHz	-60 dB	42 to 165 dB

* A-weighted noise level to maximum rms sinewave signal without clipping.

1972 1/2-inch Ceramic Microphone	1972-9601
----------------------------------	-----------

Preamplifiers

1560-P42 Preamplifier

- For electret-condenser, air-condenser, and ceramic microphones and vibration pickups



The 1560-P42 Preamplifier is a high-input impedance, low-noise preamplifier. It is particularly well suited for amplification of the output of capacitive sources, such as electret-condenser, air-condenser, and ceramic microphones and piezoelectric vibration pickups. It is an excellent choice for use with GR sound-level meters and analyzers when a long cable must be used between the microphone and the instrument. It is also a useful probe amplifier for other electrical signals where high input impedance and low noise are necessary. For example, it can increase the sensitivity and input impedance of analyzers, recorders, amplifiers, null detectors, counters, frequency meters, voltmeters, and oscilloscopes. Output from the preamplifier is through an attached 3-wire shielded cable and the required dc supply voltage is applied from one of the wires to ground.

Gain: $1:1$ or $10:1$ (20 dB) ± 0.3 dB at 25° C, slide-switch controlled; $< \pm 0.3$ -dB gain change, from that at 25° C, from -30 to $+65^{\circ}$ C.

* Federal stock numbers are listed before the Index.

Recommended Combination of Transducers, Adaptors, and Preamplifiers

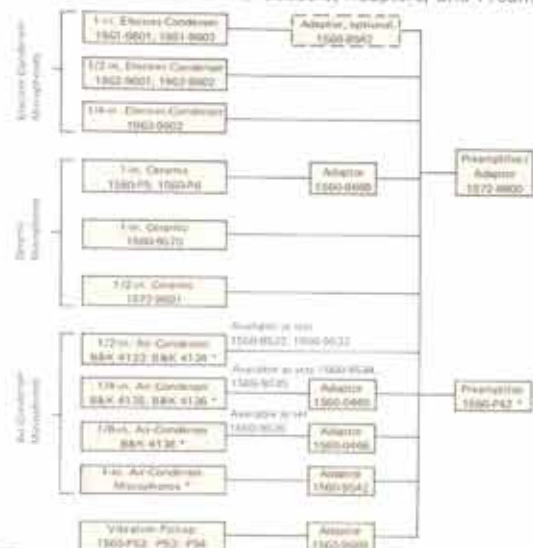

* Air-condenser microphones may not be used with the 1972-9600 Preamplifier, because they require polarization voltage; use the 1560-P42.

Frequency Response (at 1-V rms open-circuit output behind 600 Ω , -30 to $+55^\circ\text{C}$):

	3 Hz	5 Hz	20 Hz	100 kHz	300 kHz	500 kHz
1:1 gain	± 3 dB	± 1 dB	± 0.25 dB		-1 dB	
10:1 gain	± 3 dB	± 1.5 dB	± 0.3 dB		± 2 dB	

Impedance: INPUT: 6 pF; ≈ 500 M Ω at low audio frequencies; driven shield reduces input-capacitance loading for condenser microphones. OUTPUT: ≈ 15 Ω in series with 3.3 μF .

Output: SIGNAL: Up to 11 V pk-pk to 10 kHz into open circuit with 15-V supply, decreasing to 2 V pk-pk for 1:1 gain and 1 V pk-pk for 10:1 gain at 100 kHz. Up to 10-mA rms output with 1560-P62 Power Supply. POLARIZING VOLTAGE: $+200$ V $\approx 5\%$ behind 300-M Ω dc source resistance; on-off slide-switch controlled; temperature coefficient 0.1%/°C; frequency >50 kHz.

Noise: <3.5 - μV equivalent input with 390-pF source capacitance, C-weighted, 10-kHz effective bandwidth.

Distortion: $<0.25\%$ harmonic distortion at 1 kHz with 1-V rms open-circuit output; $<1\%$ at 10 kHz with 1-V rms output into 0.1 μF (equivalent to 2000 ft of cable).

Terminals: INPUT: 0.460 x 60 thread for direct connection to 1/2-in. microphones and adaptors. ACCEPTS INSERT CALIBRATION SIGNAL: 10 $\Omega \pm 20\%$ insert resistance, <0.5 -dB nom-

inal loss between connector and microphone terminals, 1-V rms max insert voltage. OUTPUT: 10-ft cable with 3-pin A3 mike connector, separate ground and shield reduce sensitivity to interference.

Available: Condenser microphone sets that include 1560-P42, vibration pickups, tripod, cables and adaptors. (See block diagram.)

Power: $+15$ to $+25$ Vdc, 1 to 2 mA idling (200 V off) or 3 to 5 mA idling (200 V on). Available directly from 1523, 1558, 1568, 1564, 1909, 1911, 1913, 1921, or 1925 Analyzers, 1525 Recorder, 1561 Sound-Level Meter, 1934 Noise-Exposure Meter, 1566 Multichannel Amplifier, or from 1560-P62 power supply when preamplifier is to be used with 1565 or 1551 Sound-Level Meter, 1553 Vibration Meter, and 1900 or 1910 Analyzer.

Mechanical: DIMENSIONS (less cable): 6.5 in. (165 mm) long x 0.5 in. (13 mm) dia. WEIGHT (with cable): 1 lb (0.5 kg) net, 3 lb (1.4 kg) shipping.

Description	Catalog Number
1560-P42 Preamplifier	1560-9642
Adaptor (to most 1-in. condenser microphones)	1560-9542
Adaptor (to vibration pickups and 1-in. ceramic microphones)	1560-9669

1972-9600 Preamplifier/Adaptor



The Preamplifier/Adaptor provides the high input impedance required by electret-condenser and ceramic microphones, unity voltage gain, and the capability to drive cables up to 100 feet in length. The amplifier requires a 9- to 25-volt dc power supply or normal connection to the 1560-P62 Power Supply or most any GR acoustic instrument.

The 1972-9600 has the same input connector as the 1560-P42 Preamplifier; unlike the latter, it does not provide polarization voltage for air-condenser microphones. It may be driven from the same kind of transducer as the 1560-P42 with the exception of any that require polarization voltage. (See block diagram.)

Gain: 0 dB, $+0$ -0.25 dB, at 1 kHz.

Frequency Response: ± 1 dB, 5 Hz to 100 kHz; ± 3 dB, 3 Hz to 500 kHz (at 0.1 V rms output into an open circuit, driven from 600- Ω source).

Input Impedance: ≈ 3 pF in parallel with 1 G Ω , at low audio frequencies.

Output Impedance: Less than 20 Ω in series with 6.8 μF .

Output: MAXIMUM VOLTAGE AVAILABLE: ≥ 10 V pk-pk, open circuit, at frequencies ≤ 100 kHz, with $+15$ -V supply. CURRENT (available): >1 mA, pk, with $+15$ -V supply.

Noise: <2.5 μV equivalent input noise voltage, with 390-pF source capacitance, C weighted.

Distortion: 0.1% total harmonic distortion for frequencies ≤ 100 kHz, at 1 V rms output level, open circuit, $+15$ -V supply.

Terminals: INPUT: Coaxial, with 0.460 x 60 thread for direct connection to most microphones (see block diagram). OUTPUT: Switchcraft type A3M microphone connector, mates with 3-wire extension cables 1560-9665, -9666, -9667.

Power: 9 to 25 V (1 mA at 9 V). Available from most GR analyzers or 1560-P62 power supply. (See list with 1560-P42.)

Mechanical: DIMENSIONS: 0.75 in. dia x 3.44 in. long (19 x 87 mm). WEIGHT: 3 oz (85 g) net.

Preamplifier/Adaptor	1972-9600
----------------------	-----------

1560-P40 Preamplifier

■ For ceramic microphones and vibration pickups



The 1560-P40 Preamplifier is a high input-impedance, low noise preamplifier similar to the 1560-P42 Preamplifier above except it produces no polarizing voltage and therefore cannot be used with condenser microphones.

A 1-inch ceramic microphone (1560-9570 cartridge, adaptor removed) plugs into the input end of the preamplifier case. The output from the preamplifier goes through a 3-terminal shielded connector, 1 terminal of which (with ground) brings in the required dc power.

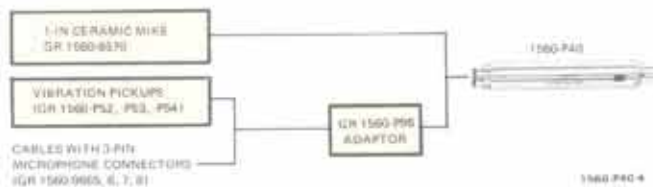

Frequency Response:

	3 Hz	5 Hz	20 Hz	250 kHz	500 kHz
1:1 gain			± 1 dB	± 0.25 dB	
10:1 gain	± 3 dB	± 1.5 dB	± 0.25 dB	± 1.5 dB	

Gain: 1:1 or 10:1 (20 dB) ± 0.3 dB at 25°C , slide-switch controlled; $\leq \pm 0.3$ -dB gain change (from that at 25°C) from -30° to $+55^\circ\text{C}$.

Impedance: INPUT: 6 pF, >500 M Ω at low audio frequencies. OUTPUT: ≈ 20 Ω in series with 3.3 μF at 1:1 gain, ≈ 100 Ω in series with 3.3 μF at 10:1 gain.

Noise: <2.5 - μV equivalent input with 400-pF source capacitance, C weighted, 10-kHz effective bandwidth.

Distortion: $<0.25\%$ harmonic distortion at audio frequencies with 1 V pk-pk open-circuit output; 1% at 1 kHz with 5 V pk-pk into 0.1 μF (equivalent to 200 ft of cable); 1% at 1 kHz with 2 V pk-pk into 0.01 μF .

Available: Ceramic microphones, vibration pickups, tripod, cables, and adaptors. 1560-P96 adaptor converts input to accept 3-pin mike connectors.

Power: $+15$ to $+25$ V dc, 1 to 2 mA. Available from same sources as 1560-P42.

Mechanical: DIMENSIONS: 6.88 in. (175 mm) long x 1.56 in. (30 mm) dia. WEIGHT: 0.6 lb (0.3 kg) net, 3 lb (1.4 kg) shipping.

1560-P40 Preamplifier	1560-9640
1560-P96 Adaptor, to microphone connector	1560-9696

† Federal stock numbers are listed before the Index.

Power Supply

1560-P62 POWER SUPPLY Required with 1560-P40, -P42, or 1972-9600 Preamplifiers when they are used with instruments that do not include a source of power such as the 1551 and 1565 Sound-Level Meters or 1900 and 1910 Analyzers. Also useful when long cables are to be driven at high levels and as a charger for rechargeable batteries in the 1561 Sound-Level Meter or 1952 Universal Filter.

A single front-panel control selects operating mode: OFF, CHARGE ONLY, CHARGE AND OPERATE, OPERATE ONLY, REMOTE (off or operate-only mode selected remotely by instrument such as 1561 or 1564 analyzer), and BATTERY CHECK. The batteries are easily removed by a slide-out clip and fit into the same type of holder used in the 1952 Universal Filter.

Input: 100 to 125 or 200 to 250 V, 50 to 60 Hz.

Output: 18 to 21 V dc, 15 mA max; automatic limiting protects supply and prevents deep battery discharge. **BATTERIES:** Two rechargeable Ni-Cd batteries provide up to 225 mA-hours operation at room temperature between charges. **RIPPLE:** <5 mV rms in CHARGE-OPERATE mode. **CHARGE TIME:** 14 to 16 h for completely discharged battery, constant 22-mA battery-charging current. Rear-panel slide switch selects internal or external battery.



Interface: INPUT (from preamp): Power to, and signal from, preamplifier. Use Switchcraft type A3M microphone connector. OUTPUT (to analyzer): Signal from preamplifier and remote power control. Use Switchcraft type A3F microphone connector. **ADDITIONAL OUTPUT:** Miniature phone jack for connection to 1933 sound-level meter/analyzer and patch cable fitted with miniature phone plugs (listing follows).

Supplied: 1560-9665 4-ft cable to connect to 1551, 1561, 1564, etc; 1560-9668 4-ft adaptor cable to connect to 1900, 1910, etc; and cable to connect to 1561 charging terminals.

Remote Operation: With line voltage not connected, preamplifier can be set to Operate-Only mode by signal of +15 to 25 V at 300 μ A.

Environmental: TEMPERATURE: -15 to +50°C operating.

Mechanical: Convertible Bench cabinet. **DIMENSIONS** (wx hxd): Bench, 8.5x3.84x5.5 in. (216x98x140 mm); rack, 19x3.84x6.02 in. (483x98x153 mm). **WEIGHT:** Bench, 3 lb (1.4 kg) net, 5 lb (2.3 kg) shipping; rack, 5.5 lb (2.5 kg) net, 8 lb (3.7 kg) shipping.

Description	Catalog Number
1560-P62 Power Supply, Bench Model	1560-9575
1560-P62 Power Supply, Rack Model	1560-9576
480 Rack-Adaptor Set	0480-9742

Accessories for Acoustic Instruments

Microphone Windscreens

These microphone windscreens reduce the effects of ambient wind noise and protect the microphone diaphragm in oily, misty, or dusty environments. They attach easily to any 1-inch microphone and do not appreciably alter the sensitivity or frequency response of the microphone. The windscreens are made of reticulated polyurethane foam and can be conveniently washed if they become soiled.

Wind-Noise Reduction: 20 dB in winds \leq 30 mph.

Microphone Sensitivity Loss: 0 dB to 3 kHz, \approx 0.5 dB to 5 kHz, \approx 2 dB to 12 kHz; see curve.

Windscreens are also available for $\frac{1}{2}$ -inch microphones. Their specifications are similar to those for 1-inch microphones.



Microphone Windscreens, 4 each per pack
For 1-in microphones
For $\frac{1}{2}$ -in microphones

1560-9521
1560-9522

Tripod

1560-9590 TRIPOD Versatile — accepts a variety of equipment. A $\frac{1}{4}$ -20 threaded stud fits all GR sound-level meters and electronic stroboscopes, a 1-in. sleeve accepts the 1560-P40 and 1972-9600 Preamplifiers, and a $\frac{1}{2}$ -in. sleeve accepts the 1560-P42 Preamplifier.

Description	Catalog Number
Tripod	1560-9590



Extension Cables

Preamplifier Cable Shielded 3-wire-plus-ground cable terminated in Switchcraft Type A3 3-terminal microphone connectors (male and female). For use between preamplifier output and analyzer. Mates directly with input and output connectors of 1560-P62 Power Supply and most GR acoustic instruments. Provides a wire to carry power from analyzer (for example) to preamplifier.

Net Weight: -P72D, 4.5 oz (127 g); -E, 13 oz (369 g); -F, 2.3 lb (1.1 kg).

Description	Catalog Number
Preamplifier Cable	
1560-P72D Extension Cable, 4 ft	1560-9665
1560-P72E Extension Cable, 25 ft	1560-9666
1560-P72F Extension Cable, 100 ft	1560-9667

Microphone Cable Low-noise shielded extension cables with Switchcraft Type A3 connectors (male and female, pin 2 unused). Used for connecting (for example) the 1560-P5

ceramic microphone to the input of an acoustic instrument having the mating input connector. Note: Will not conduct power to remote preamplifier; see cables listed above.

Net Weight: -P73, 1.1 lb (0.5 kg); -P73B, 3.7 lb (1.7 kg).

Description	Catalog Number
Microphone Cable	
1560-P73 Extension Cable, 25 ft	1560-9673
1560-P73B Extension Cable, 100 ft	1560-9982

1933 extension cable, 4-wire, for extending the 1933 Preamplifier from the instrument case (not for general use).
Net Weight: 1.5 lb (0.7 kg).

Extension cable for 1933, 60 ft	1933-9601
---------------------------------	-----------

Patch Cables

Shielded patch cords and adapting cables, for general use. **Net Weight:** For 3-ft lengths, ≈2 oz (57 g); for 2-ft lengths, ≈1.4 oz (40 g).

Miniature-Phone-Plug Adapting Cables With miniature phone plug at one end. Various versions have at the other end a double (in-line) banana plug or other regular-sized connectors, as listed.

Miniature Phone-Plug Patch Cords	
1560-P77, with Double Banana Plug, 3 ft	1560-9677
1560-P78, with 1/4-in. Phone Plug, 3 ft	1560-9678
1560-P79, with BNC Plug, 3 ft	1560-9679
1560-P80, with 1/2-in. Phone Jack, 2 ft	1560-9680

Phone-Plug Cables With 1/4-in. phone plug at one end. Other end, either similar or with hammerhead double-banana plug.

1560-P76 Patch Cord, Phone Plug, 3 ft	1560-9676
1560-P95 Adaptor Cable, Phone/Banana Plug, 3 ft	1560-9695

BNC- and Banana-Plug Cables With both ends identical. One version male BNC. The other version has in-line double banana plugs.

776-C Patch Cord, with BNC plugs, 3 ft	0776-9703
274-NQ Patch Cord, with Double Banana Plugs, 3 ft	0274-9860

Adaptors



1560-9669 Adaptor Adapts 1560-P42 Preamplifier input to Switchcraft type A3 3-pin microphone connector (female). See note, below.

1560-P96 Adaptor Converts inputs of 1560-P40 Preamplifier and 1565 Sound-Level Meter to A3 3-pin microphone connector (female). Note: This adaptor can be made easily by removing a part from the 1560-9669 (above).



1560-9542 Adaptor Provides proper mechanical and acoustical coupling between a 1-inch air- or electret-condenser microphone (including 1961-9601 and -9602 microphones and Western Electric 640AA laboratory standard microphone) and the 1560-P42 Preamplifier.

1562-9601 1/2-in. Microphone Adaptor Adapts the 1562 Sound-Level Calibrator to fit GR 1/2-in. electret-condenser and ceramic microphones.

1562-9603 1/4-in. Microphone Adaptor Adapts the 1562 Sound-Level Calibrator to fit GR 1/4-in. electret-condenser microphones.



1560-9561 Coupler/Adaptor Set Adapts 1/2, 1/4, and 1/8-in. Bruel and Kjaer air-condenser microphones to 1562 Sound-Level Calibrator.

Adaptors	
Microphone Connector to Preamplifiers	1560-9669
1560-P96, Microphone Connector to Preamp.	1560-9696
1 in Microphone to Preamp	1560-9542
1/2-in Microphone to Calibrator	1562-9601
1/4-in Microphone to Calibrator	1562-9603
Coupler/Adaptor Set, Microphones to Calibrator	1560-9561

Preamplifier Accessories

1962-3200 Microphone Attenuator Attenuates output of 1962 1/2-in. Electret-Condenser Microphones by 10 dB, to allow operation of microphones at high levels.

1560-P9 Dummy Microphone Shielded 35 pF capacitor. Used to simulate a 1962 1/2-in. Electret-Condenser Microphone to determine instrument noise floor. BNC input connector also provided to connect a signal source, simulating a sound signal. BNC shorting plug supplied.

1560-P35 Permanent-Magnet Clamp For firm holding of a vibration pickup to a ferrous metal surface.

Preamp Accessories	
Microphone Attenuator	1962-3200
1560-P9 Dummy Microphone	1560-9609
1560-P35 Permanent-Magnet Clamp	1560-9635

⊕ Federal stock numbers are listed before the Index.

Condenser Microphone Systems

The following microphone sets include a microphone cartridge†, a 1560-P42 Preamplifier, all adaptors necessary to mate the cartridge to the preamplifier and to a 1562 Sound-Level Calibrator, and a carrying case for all components including the preamplifier.

Mechanical: DIMENSIONS (wxhxd): 10x2x7.25 in., 254x51x184 mm. WEIGHT: 2.5 lb (1.1 kg) net, 6 lb (2.7 kg).



Nominal Frequency Range	Nominal Sensitivity Level* re 1 V/N/m ²	Typical Dynamic Range** re 20 µN/m ²	Description	Catalog Number
1560-9532 1/2-INCH CONDENSER MICROPHONE SET , flat perpendicular response.				
20 Hz to 40 kHz	-40 dB	31 to 145 dB	1/2-in. Condenser Microphone Set	1560-9532
1560-9533 1/2-INCH CONDENSER MICROPHONE SET , flat random-incidence response.				
20 Hz to 20 kHz	-40 dB	31 to 145 dB	1/2-in. Condenser Microphone Set	1560-9533
1560-9534 1/4-INCH CONDENSER MICROPHONE SET , flat perpendicular response.				
50 Hz to 100 kHz	-54 dB	49 to 158 dB	1/4-in. Condenser Microphone Set	1560-9534
1560-9535 1/4-INCH CONDENSER MICROPHONE SET , flat random-incidence response.				
50 Hz to 70 kHz	-60 dB	55 to 165 dB	1/4-in. Condenser Microphone Set	1560-9535
1560-9536 1/8-INCH CONDENSER MICROPHONE SET , flat random-incidence response.				
70 Hz to 140 kHz	-73 dB	69 to 178 dB	1/8-in. Condenser Microphone Set	1560-9536

* Sensitivity level in the microphone-preamplifier combination is given for X1 (unity-gain) setting of the 1560-P42 Preamplifier; sensitivity is increased by 20 dB by use of the X10 setting of the 1560-P42.

** A-weighted noise level to maximum rms sinewave signal level without clipping.

† The microphones supplied in these sets are manufactured by Bruel and Kjaer, Naerum, Denmark.

Guide to Microphone System Selection

The microphones, preamplifiers and power supplies listed on the preceding pages may be put together to make complete microphone systems, or one of the air-condenser microphone systems (or sets) may be selected.

Microphone Selection First determine the frequency range and lowest sound level to be measured. Then, select a microphone that will fulfill these requirements. Note that the noise floor for each microphone will be lower if the measured signal is analyzed with full octave or narrower bandwidth filters.

Preamplifier Selection Three preamplifiers are offered. The 1560-P42 is the most versatile, as it can be used with all GR microphones and condenser microphones from other manufacturers. It can drive very long cables and provides a voltage-gain choice of 1 or 10 (0 or 20 dB).

The 1972-9600 Preamplifier/Adaptor has the same input fitting as the 1560-P42; however, the former does not have the polarization voltage capability and, therefore, cannot be used with air-condenser microphones. This

unity-voltage-gain preamplifier is recommended for driving cables up to 100 feet (30 m) long.

The 1560-P40 Preamplifier was designed for use with the 1560-9570 Microphone (with adaptor base removed). It will work well with accelerometers and other electrical inputs when used with the 1560-P96 Adaptor. This preamplifier provides a voltage-gain choice of 1 or 10 (0 or 20 dB) and may be used with cables of moderate length.

Power Supplies All the preamplifiers mentioned above require power to operate them; many GR sound measuring instruments supply it directly. (Consult the power specifications of the 1560-P42 or the specifications for the specific instrument of interest to see whether this power is supplied). If a separate power supply is required, use the 1560-P62. This should always be used (even with instruments that supply preamplifier power) if very long cables (over a few hundred feet) are to be driven, as the preamplifier power supplies built into most instruments have limited current capability.

Vibration Pickups and Systems

- accessories for sound-level meters
- select for:
 - high-frequency performance
 - high sensitivity
 - general application, economy

For the measurement of solid-borne vibrations with the sound-level meter a vibration pickup is used in place of the microphone.

Each of these vibration pickup systems consists of a vibration pickup, a control box, and a connection cable. The vibration pickup is an inertia-operated, ceramic device, which generates a voltage proportional to the acceleration of the vibrating body. By means of integrating networks in the control box, voltages proportional to velocity and displacement can also be delivered to the sound-level meter. The desired response is selected by means of a three-position switch on the control box. Conversion data are supplied for translating the decibel indications of the sound-level meter into the vibration parameters of displacement, velocity, and acceleration.

Type 1560-P11B

This system uses a lead-zirconate-titanate pickup, identical with that used on the 1553-A Vibration Meter. Probe and probe tips are provided. A permanent-magnet mount is also available.

The 1560-P11B Vibration Pickup System with the 1551-C Sound-Level Meter.



Type 1560-P13

For measurements at higher frequencies than the -P11B system affords, the -P13 combination is recommended, consisting of the 1560-P53 Vibration Pickup and the 1560-P23 Control Box. A small holding magnet is included.

This system with the Type 1551-C or -B Sound-Level Meter provides the flat frequency response and low-noise operation required by MIL-STD-740 (SHIPS) for vibration measurement. (The holding magnet is not used for measurements according to that standard.)

Type 1560-P14

The vibration pickup used in this system has approximately 10 times the sensitivity and 10 times the impedance of the 1560-P52.

Pickup Systems	General Purpose 1560-P11B Vibration Pickup System	High Frequency 1560-P13 Vibration Pickup System	High Sensitivity 1560-P14 Vibration Pickup System
Ranges of Measurement Rms Acceleration (in./s ²)	0.1 to 39,000 (100 g)†	0.3 to 390,000 (1000 g)†	0.01 to 3900 (10 g)†
Rms Velocity (in./s)	0.001 to 300 at 20 Hz* 100 at 60 Hz 10 at 600 Hz	0.001 to 1000 at 20 Hz** 1000 at 60 Hz* 100 at 600 Hz	0.0001 to 30 at 20 Hz* 10 at 60 Hz 1 at 600 Hz
Rms Displacement (in.)	0.00003 to 1 at 30 Hz* 0.1 at 100 Hz	0.00003 to 10 at 30 Hz* 1 at 100 Hz	0.000003 to 0.1 at 30 Hz* 0.01 at 100 Hz
Frequency Range			
Response characteristics for constant applied (1) acceleration, (2) velocity, and (3) displacement.			
Net Weight of System (lb)	1½ (0.8 kg)	1½ (0.8 kg)	2 (1 kg)
Shipping Weight (lb)	5 (2.3 kg)	5 (2.3 kg)	5 (2.3 kg)
Catalog Number	1560-9922	1560-9613	1560-9614

Pickup Characteristics

Pickup Type Number	1560-P52	1560-P53	1560-P54
Sensitivity (mV/g, nominal)	70	70	700
Temp Coeff of Sens (dB/°C)	<-0.01	<0.02	0.01
Resonant Frequency (Hz)	3200	27,000	5000
Capacitance (pF)	10,000	350	700
Temperature Range (°C)	-18 to 100	-54 to 177	-18 to 120
Relative Humidity Range (%)	0 to 100	0 to 100	0 to 100
Cable Length (ft)	5 (1.55 m)	8 (2.5 m)	8 (2.5 m)
Dimensions (in.)	1½x1½x¾	¾ (hex) x 0.7	1¾ (dia) x 1½
(mm)	42x37x15	15.5x18	31x27
Net Weight (oz)	1.6 (45 grams)	1.1 (31 grams)	3.1 (90 grams)
Catalog Number	1560-9652	1560-9653	1560-9654

† g = acceleration of gravity.

* Upper limit of displacement and velocity measurements depends upon frequency and is determined by the maximum acceleration possible before nonlinearity occurs (100 g for 1560-P11B, 1000 g for 1560-P13, and 10 g for 1560-P14).

** Maximum reading of instrument.

⊗ Federal stock numbers are listed before the Index.

1557-A Vibration Calibrator

- calibrates vibration pickups, meters
- generates 1 g at 100 Hz
- portable, battery-operated

This calibrator provides a single-frequency (100 Hz), single-level (1 g) check on the GR Vibration Pickups, the 1553 Vibration Meter, or any pickup whose total mass is 300 grams or less. It can provide on-the-spot calibration of vibration-measuring systems immediately before and after important measurements and can also be used to compare transducers or to calibrate working transducers against a standard transducer.

Operation of the calibrator is simple. A pickup of known mass is attached to the shaker, either in place of one of the removable 50-gram disks or to one of the disks by double-faced, pressure-sensitive tape. The user adjusts the Level control until the panel meter, calibrated in grams, indicates the mass of the pickup. The pickup will then be automatically subjected to an acceleration of 1 g at 100 Hz.

The 1557-A is a small, battery-operated unit consisting of a transistorized electromechanical oscillator and a cylindrical shaker. The acceleration output of the calibrator appears at two pillbox-shaped, 50-gram disks mounted on an internal cylinder that projects through the sides of the instrument.



Also see Sound-Level Calibrators, Types 1562-A and 1567.

SPECIFICATIONS

OUTPUT

Acceleration: 1 g rms $\pm 10\%$. 1 g = 386 in./s² (9.81 m/s²).

Velocity: 0.614 in./s (15.6 mm/s) rms.

Displacement: 0.000978 in. (0.0248 mm) rms; 0.00277 in. (0.0704 mm) pk-pk.

Frequency: 100 Hz $\pm 1\%$ for 50-gram load; 100 Hz +0, -2% for 300-gram load.

GENERAL

Batteries: Four RM-4R (or equivalent) mercury cells. Battery life is 100 hours of continuous operation. (Dry battery optional; please specify. Replacement is Eveready 724 or equivalent.)

Supplied: Leather carrying case.

Mechanical: Aluminum case. DIMENSIONS (wxhxd): 4x8x4 in. (105x205x105 mm). WEIGHT: 3.25 lb (1.5 kg), net; 5.25 lb (2.4 kg) shipping.



View of the calibrator with Type 1560-P52 Vibration Pickup attached.

Description	Catalog Number
1557-A Vibration Calibrator	1557-9701
1557-A Vibration Calibrator (with dry battery)	1557-9702
Replacement Mercury Cell, 4 req'd	8410-1372
Replacement Dry Cell, 1 req'd	8410-1050

* Federal stock numbers are listed before the Index.



1720 Otoadmittance Meter as used in measurement of middle-ear function.

Audiometry and Psychoacoustics

One of the forces that drew General Radio and Grason-Stadler together was their common involvement in acoustic research and the measurements that relate to it. Described on these pages are several of Grason-Stadler's major products, products that are used extensively by hearing clinicians and by researchers in hearing and the behavioral sciences. Complete information on these G-S products appears in Grason-Stadler's **Catalog 100**.

Instruments for Hearing Research

Audiometry Under license from Georg von Békésy, Grason-Stadler produced the first commercial Békésy audiometer two decades ago and has since installed these units in clinics and hospitals all over the world. G-S's present line of audiometers consists of a growing family of manual and automatic audiometers ranging in purpose from monitoring to diagnosis and research. The **1703 Recording Audiometer** (see page 35) is designed to be used under conditions in which large numbers of subjects must be tested in minimum time — as in industrial-hearing-conservation programs.

The **1704 Audiometer** is a two-channel, fixed-frequency, pure-tone/speech manual audiometer with range, accuracy, and flexibility suitable for diagnostic

applications. The **1702** provides identical features but adds the capability of automatic Békésy-type fixed-frequency presentation and recording to the manual capabilities of the 1704. The **1701**, the most sophisticated unit of the G-S audiometer line, is a full-fledged sweep-frequency/speech audiometer available in both manual and automatic versions, and suitable for the most exacting clinical and research applications.

Of interest to both clinicians and researchers is the G-S **1720 Otoadmittance Meter**, a precise and convenient tool for deriving objective information about the middle ear. The 1720 measures acoustic admittance as a function either of variable air pressure in the ear canal or of acoustic reflex.

Also of interest to clinicians and researchers is the G-S **3951 Evoked Response System**. The 3951 is a versatile package consisting of a signal averager, recorder, neurological amplifier, and sufficient digital control equipment to implement a variety of procedures involving cortical potentials.

Psychoacoustics Designing and manufacturing special-purpose instruments for hearing research have been specialties of G-S since its founding. What began as a varied line of single-purpose devices has been converted

into modular form and made compatible with G-S's modular Series 1200 digital programming system. Users can now quickly and easily assemble nearly any special-purpose instrumentation for signal generation, control, and/or monitoring they require, often with far greater capability than any commercially available unit. Moreover, when current requirements are satisfied, users can reconnect their modules to deal with new and quite different requirements.

Accessories Grason-Stadler provides an extensive selection of accessories for its audiometric and psychoacoustic instruments — booster amplifiers, calibrated earphones, loudspeakers, tape recorders, phonographs, X-Y plotters, etc. In addition, through its affiliation with General Radio, it can provide acoustic stimulus generators, sound-level meters, distortion analyzers — virtually any instrument necessary to the generation, measurement, or monitoring of acoustic waveforms.

Research Automation

In the mid-1950's, Grason-Stadler became one of the first companies in the United States to provide economical, modular, relay-based experiment control equipment for the growing need of behavioral researchers to automate and replicate increasingly complex experiments. Although this relay system continued to fill many research needs, developments in behavioral research and in the life sciences in general have required control and monitoring devices with more speed and flexibility than relays provide. Grason-Stadler's response to these requirements has been to develop three separate programming systems; the first is based on relays, the second on solid-state logic, and the third on computer control.

The 1100 Relay System This updated version of the original relay system provides low-cost automatic control of and data collection from moderately complex experiments whose events occur at rates up to 15 per second. The system permits generating a wide range of relationships between stimulus and response events — fixed and variable ratios, fixed and variable intervals, detection of coincidence, etc. Inputs from contact closures can be programmed to control devices such as food dispensers, slide projectors, shock generators — virtually anything whose operations can be governed by contact closures. Modules provide basic programming functions such as counting, timing, and stepping. Experiment parameters are established by means of connections between front-panel snap studs. Programs can be changed quickly and easily by modification of these connections.

The Solid-State 1200 System This system is smaller, quieter, and much faster than the 1100 Relay System, and it permits automatic control of and data collection from complex experiments with event rates up to 10,000 per second. Because the 1200 System is faster, it can make more sophisticated decisions — from detection of coincidences lasting only a few microseconds to near-instantaneous random-number generation and related program modifications.

Series 1100 Relay Programming System — economy and flexibility in experiment automation.

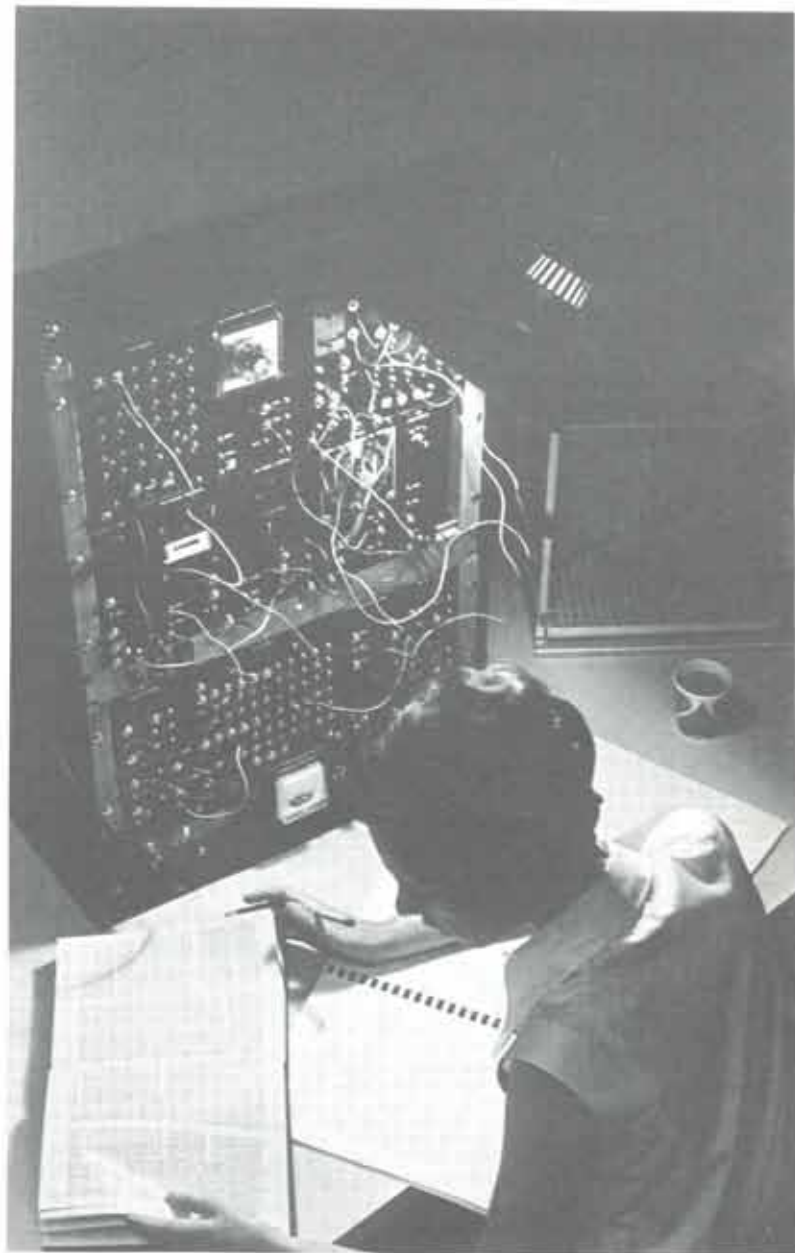

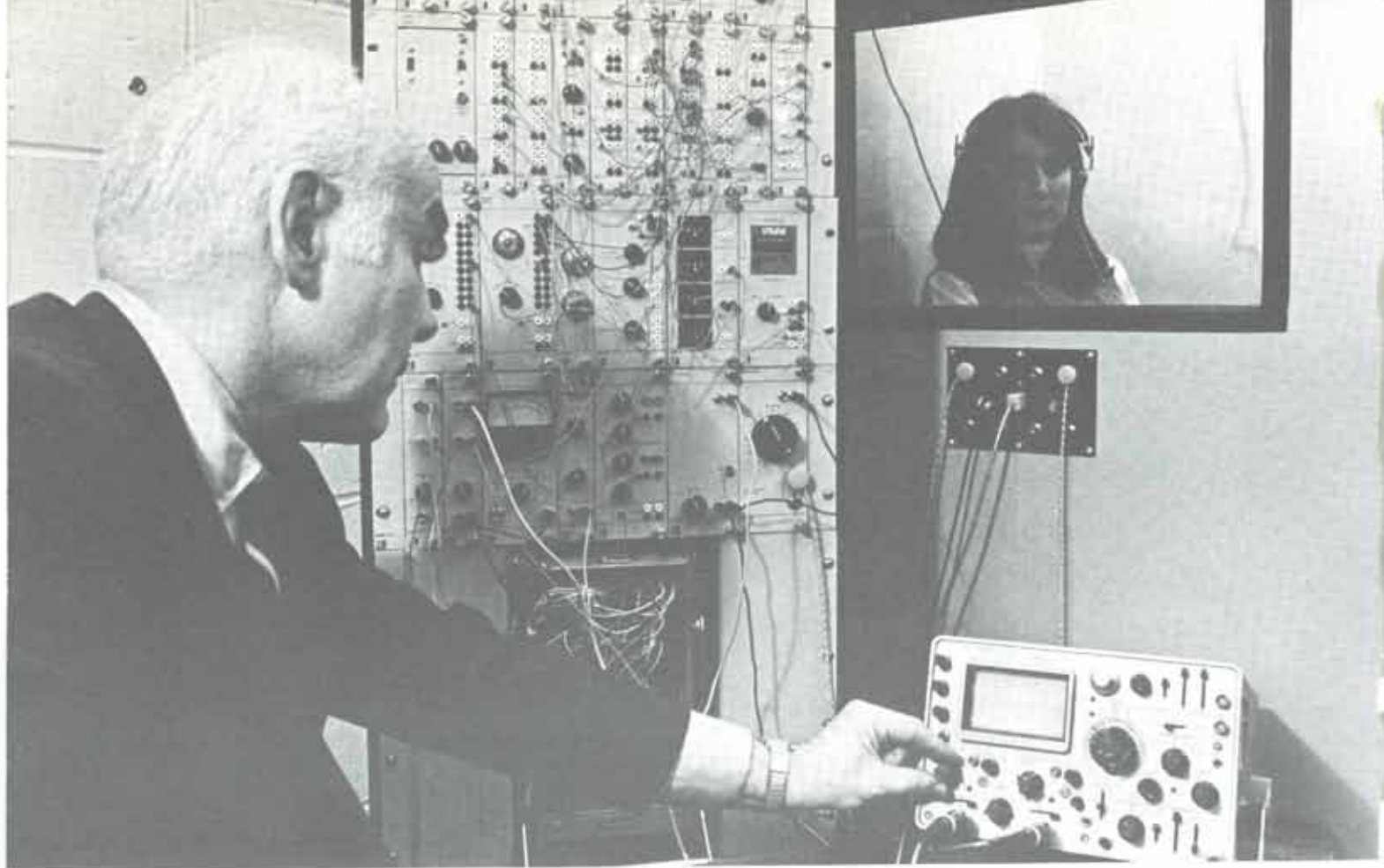

Series 1200 Programming System — versatile control of experiment variables in psychoacoustics and behavioral sciences.

Applications of the 1200 System range from standard schedules of reinforcement in the behavioral sciences, through complex multi-alternative forced-choice procedures in psychoacoustics, to evoked-potential threshold tests in neurophysiology. Like the 1100 System, the 1200 System is modular both in packaging and in function. Control parameters can be established either by front-panel jacks or through a quickly interchangeable central programming board.

The SCAT® System The SCAT system is designed to permit on-line, real-time automation of multiple independent or highly complex single experiments. It is an integrated hardware/software control and data-collection system that utilizes a DEC PDP-8 series mini-computer as its central processor. The SCAT hardware extends the basic capabilities of the computer by performing a variety of time-consuming converting, storing, and timing operations. The SCAT software permits the implementation, through easily-remembered commands, of complex functions such as time-measurement, counting, random-number generation, magnitude comparison, and data collection and outputting. The software also supplies a query mode that permits both interrogation and modification of on-going experiment variables.

Other G-S Products Grason-Stadler also offers animal chambers that house small animal subjects, such as rats, small monkeys, and pigeons. This equipment mates easily with the 1100, 1200 and SCAT Systems. Each chamber can be used independently or can be enclosed in a separate chest for isolation from extraneous

environmental stimuli. Chambers include as standard features manipulanda appropriate to the subject being used, stimulus lights, a loudspeaker, and a grid floor. A variety of interchangeable stimuli and reinforcement options is available.



* State-Change Algorithm Terminology.

Component And Network Test

Instruments/Systems • Manual/Automatic • Custom/Standard

Universal Test System — 2200

Logic-Circuit Testers

Resistance Trim Systems

Wire-Wrapping Systems

Linear IC Tester

Passive Test System

Leakage-Current Measuring System

Cable Test System

Transformer Test System

Component Test System

Automatic Impedance Bridges

Manual Impedance Bridges

Impedance Standards and Decade Boxes





Linear ICs

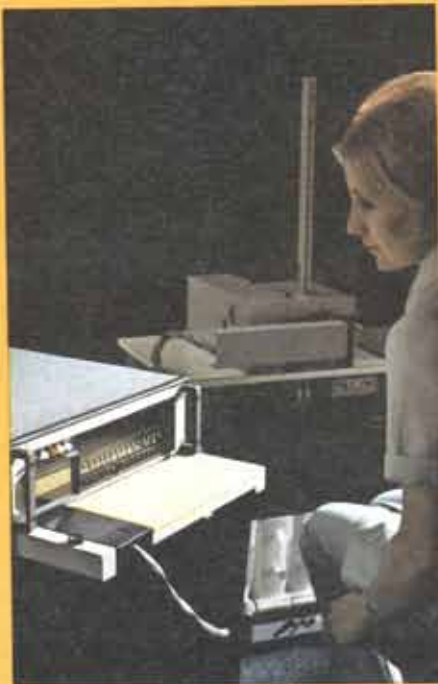

Measure:

- 18 parameters, including
- gain
- impedance
- offset voltage and current
- slew rate
- regulation
- rejection ratios

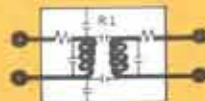

Transformers



Measure:

- inductance, inductance unbalance
- dc resistance
- transformation ratio
- capacitance



Thick- and Thin-film Resistors



Measure and Trim

- anodize systems
- for tantalum thin-film resistors
- laser systems
- for thick-film resistors



Capacitors
(Resistors, Inductors,
and Passive Networks)



Measure and Sort

- capacitance
- equivalent series resistance
- dissipation factor
- leakage current



Logic Boards

Measure:

logical function — dual-level
parametric tests
time duration and delay
voltage and current



Multipair Cables

Measure:

mutual capacitance and conductance
unbalance in capacitance and resistance
conductor resistance



Turn to GR for Automatic Test and Measurement Systems

There is only one valid reason for buying an automatic test system — to continue producing a reliable product while at the same time reducing the cost to test that product properly. During the past ten years GR has been developing an automatic test system capability that is second to none in the test and measurement industry. If you need to test components, networks, or circuits, then GR has a system that will do the job.

What does it take to become one of the world's leading suppliers of automatic test systems? You start with fifty years of experience in making electronic measurements. To this you add the knowledge of how to make these same measurements with automatic instruments or system modules. You also work closely with the major supplier of minicomputers to develop automatic systems with the best combination of speed, accuracy, and reliability.

But technical excellence is not enough! You must listen carefully to your customers' needs, create basic systems with broad usefulness, then build an engineering-manufacturing facility capable of tailoring these systems to meet your customers' specific, unique, needs. You create fast-responding sales and service facilities so that your customer will help you sell future systems because he remains satisfied before, during *and after* the sale.

When you have done all these things and more, you are one of the world's leading suppliers of automatic test systems; now and then you brag about it.

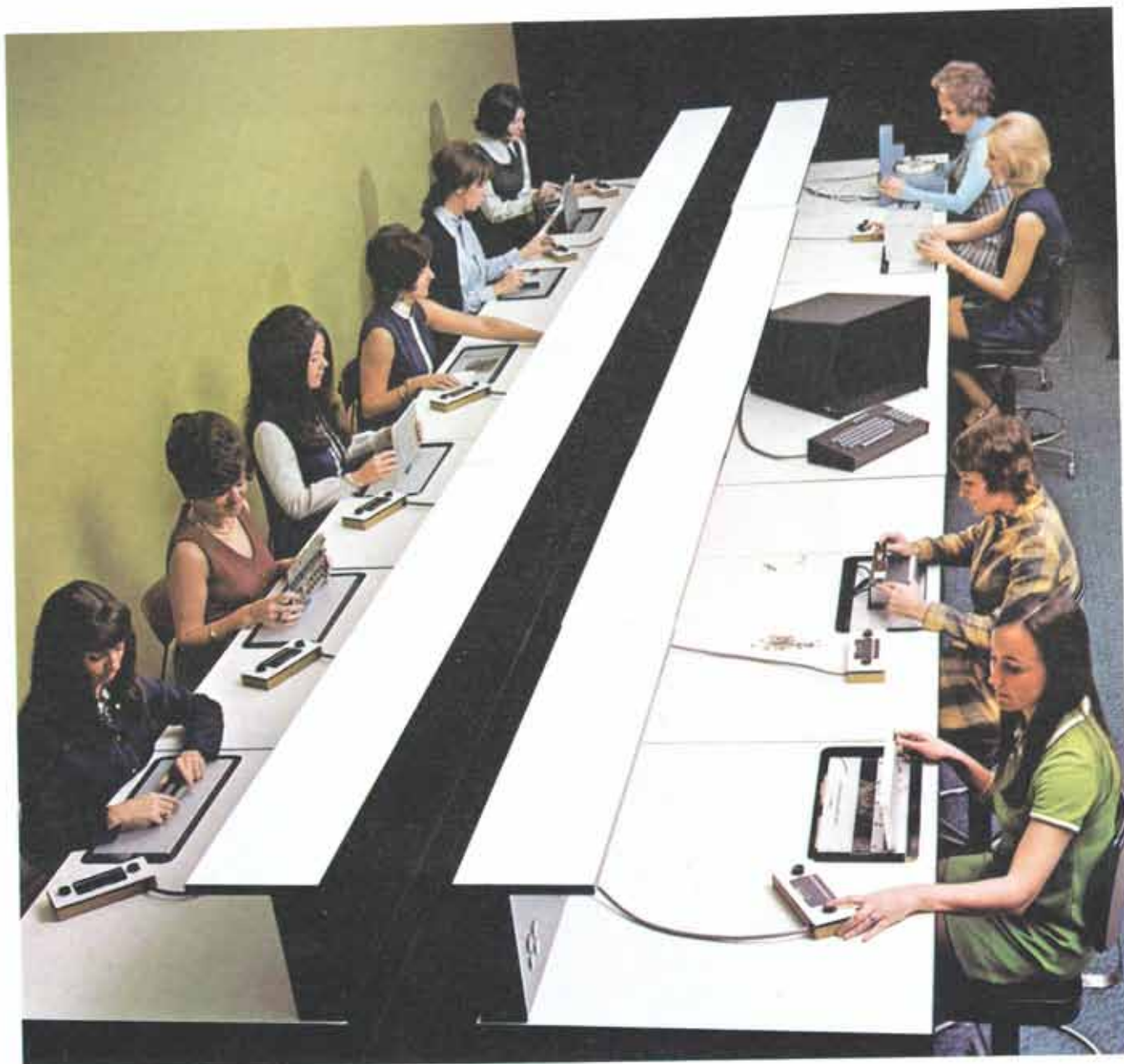

Systems 2200 Multi-station Circuit and Component Test System

New

The GR Systems 2200 is a family of test and measuring systems that contain many new measurement concepts, all aimed at one goal — providing GR customers with total-system service. GR's reputation is well established in the areas of digital, analog, and passive (impedance) measurement. Until the Systems 2200, this expertise has been represented by separate instruments. In the 2200, all these measurement capabilities are merged in a single product, under computer control. With the 2200, better measurements can be made than with separate instruments; evaluations are performed faster, more easily, and more thoroughly.

A System 2200 can have from 1 to 18 test stations. Each test station can be dedicated to a specific measure-

ment (or class of measurements) or can be a multi-purpose station capable of all the measurements in the system's repertory.

And GR does it all for you — no loose ends, no do-it-yourself adaptations, no ifs, ands or buts. The System 2200 we deliver includes all necessary hardware as well as test programs and device adaptors (though both are so easy to prepare that you don't have to depend on GR for them). The system performs as specified, and we see that it keeps working properly. GR has been around for a long time — we can back up our promises!

2200 Measurements Tests and measurements that the Systems 2200 can make include, but are not limited to, the following:

- **Digital**
 - Logic Function
 - Marginal Supply Voltage
 - High-Speed Word Acceptance
 - Time Interval
- **Analog**
 - Voltage, ac and dc
 - Current, ac and dc
 - Frequency
- **Passive**
 - Impedance, R, L, and C with dc or ac, 120 Hz to 1 MHz
 - Continuity
 - Isolation



These capabilities can be expanded through use of the system's computer as a processor to convert measurements to other, perhaps more meaningful, quantities or as a comparator to make GO/NO-GO decisions. Other functions and modes that the 2200 can provide are:

- Program editing and verification
- Error and other messages on teleprinter, CRT, or label printer
- Diagnostic subroutines or complete programs

Scanners In any measurement setup, the proper connection of sources and measuring instruments to the DUT is crucial for accurate results. In a computer-controlled system, good connections are even more important, as there is little chance for trial-and-error troubleshooting. Also, a variety of connections (shielded, guarded, Kelvin) is normally employed for various kinds of measurements to ensure accuracy. These connections must be properly selected and executed, with due consideration for proper grounding, as in any measurement system.

For just these reasons, the GR scanners used in the Systems 2200 have been designed as carefully as the measuring circuits. Thirty types of scanner-relay cards are available to make exactly the connections that your measurement requirements may demand: Single and multiple contact, wet and dry contacts, high isolation, Kelvin. . . . Provisions are included in both hardware and software to prohibit connections that would result in inadvertent ground loops.

```

EDITOR
NO ERRORS

/996 HIC START-UP PROGRAM CCE 2-22-72 TP0238/4
M010 SET RLY (3,5);+
M020 ASS REF AT (1);+
M030 SET PS-1 AT (3) U=-15.0 LIM=3;+
M040 SET PS-2 AT (4) U=15.0 LIM=3;+
M050 SET PS-4 AT (5) U=5.5 I= 100;+
M060 TEST DCV AT (5) RNG=2 (HI=5.6 LO=5.4)(9478);+
M070 SET PS-3 AT (6) U=-4.4 I= 100;+
M080 TEST DCV AT (6) RNG=2 (HI=-4.3 LO=-4.5)(8588);+
M090 SET ACS AT (2) F=777K U=8.330;+
  
```

Test Program Setup of any measurement system is frequently a hidden trap, requiring much more time than expected. The same can be true with computer-controlled measurement systems, in which the potential snare is in writing the test program. The programmer must know intimately the device to be tested (with its idiosyncrasies) and know measurement techniques and pitfalls as well. Since trial-and-error procedures are very costly at best, the program commands used to direct the connections and measurements must be explicit, unambiguous, and directly related to the test and test conditions being established.

The General Radio test language is just that kind of programming tool. The command "ASSIGN", for example, directs the connection of drivers and sensors to the DUT; "SET" establishes source or driver outputs; "MEAS" and "TEST" command measurement or comparison against a prescribed limit. Limits are specified easily as (LIM = 15 + 5% - 5%) or (HI = 5030 LO = 4980). Other commands, numerical values and the like are accepted by the program in forms directly related to normal test procedures and performance specifications.

As programmer, you can focus your attention on the proper testing of a device; from the test procedure, the program follows directly. From the program follows correct and efficient testing of the component or circuit.

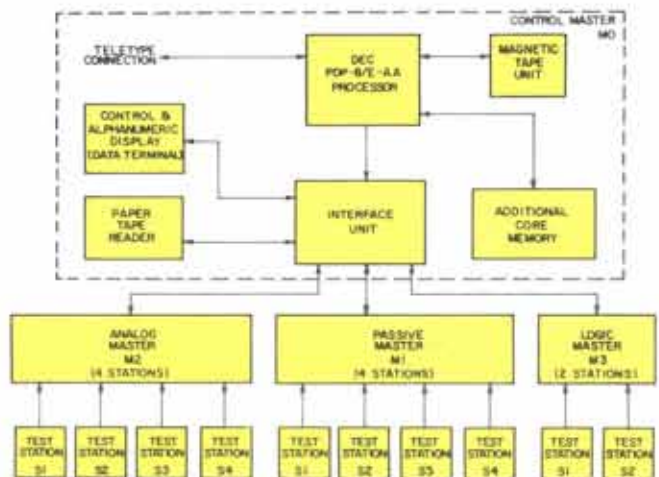

A large multi-station system.



1792 Logic-Circuit Test System

- programmable pin connections
- dual logic levels
- data terminal, 12-inch screen
- programmable power supplies
- 8-k core memory

New

The GR 1792 system includes, as standard, many features that are optional in other logic testers — features that speed program writing, verify operation, and enable the 1792 to perform more tests, faster, on more different circuits. For example: Power supplies programmable over $\pm 10\%$ permit marginal-condition tests; dual-logic-level drive and sensing permit testing of boards operating with mixed logic families. An improved test-program language further eases the writing job and increases versatility.

The basic 1792, in a handsome and convenient console, includes a data terminal with 12-inch display screen. Each pin of a circuit (60 pins or even more) can be either driven or sensed (or both for short-circuit tests) as required at each step of a test sequence. There is no more powerful logic tester available than the GR 1792.

Dual-logic level sets Circuits under test which include mixed logic levels are easily accommodated by the dual-logic-level sets in the 1792. One of two high levels can be specified for each individual pin on the circuit, such as +5 volts for TTL and +12 volts for HTL; all it takes is two simple statements in the test program.

Programmable pins Any pin of the 1792 is selected as either a driver or a sensor by means of program state-

ments. These programmable pins also provide simplified automatic input checking, such as testing for shorted inputs.

Big-screen display A large 12-inch scope displays a full page of the test program at a time — up to 23 lines of 80 characters — and all presented on an easily read format. An associated keyboard facilitates rapid program preparation and editing directly on the scope with no need to resort to the teletype.

Marginal testing Device power supplies can be varied $\pm 10\%$ by the program to test the DUT under marginal V_{cc} conditions.

8-k core memory Twice the computer core memory (compared to the 1790) in the basic system provides ample room for nearly any program plus permanent storage of all systems programs necessary to write, edit, and run the test programs. You save the time, effort, and confusion of running various systems programs in and out of memory or of manipulating any computer controls. An optional disk memory expands program storage capacity to 1 million words.

Modular design The 1792 adapts to your application, both present and future, quite simply, without the cost of frills that are nonessential to your immediate situation.

A large variety of measurement modules (instead of costly instruments) can be added at the time of purchase or later as the need develops.

The simplest setup of all You need only a test program and a socket appropriate to your device. For the program, you analyze the circuit and decide how it should be tested, such as you would for a manual test procedure. But, instead of writing an involved test specification, you describe the necessary tests in a unique GR test language — the easiest language available for any logic-circuit test system and so simple you can learn it in a few hours. Although simple, the language still permits nearly unlimited flexibility in the test program, including user-written assembly-language subroutines. An example of some of the available tests is shown.

SIMPLE TEST LANGUAGE — Typical Statements

* I A(1, 2, 10-14, 17, 23, 24)	Specifies which pins on the DUT are inputs associated with logic level set A.
* I B(18, 19, 22, CLK = 37, RESET = 51)	Specifies which pins of DUT are inputs associated with logic level set B. Also defines mnemonics to be used in place of pin numbers.
* O A(3, 4, 25, 31, 39)	Specifies which pins on DUT are outputs associated with level A.
* O B(6, 9, 15, 64, 81)	Specifies which pins on DUT are outputs associated with level B.
PLOW	Specifies that tests are to be run with low power supply voltage on DUT.
IH(1, 19, RESET)	Sets specified inputs high, leaves other inputs as they were in previous test.
IL(17, 22, 24)	Sets specified inputs low, leaves other inputs as they were in previous test.
OH(3, 9, 25, 31)	Checks that specified outputs are high and that other outputs are as they were in previous test.
OL(6, 64, 39)	Checks that specified outputs are low and that other outputs are as they were in previous test.
SEQUENCE (CLK, 19, 23)	Generates a sequence of tests with all combinations of the specified inputs.
DO 17, 100	DO loop provides a means of repeating a series of tests; here the loop contains the next test through test 17 and is repeated 100 times.
IGNORE (#9, 15, 25, 39)	Program ignores all output pins except 9, 15, 24 and 39.
CALL (1, 2, 19, 4) 310	Transfers program to subroutine beginning at test 310. Subroutines enable use of a particular sequence of tests more than once during test program, with only the designated pins affected.
PRINT Change IC 341	Displays message to operator on CRT display.
GOTO 71	Transfers the program to test 71.
TYPE REPLACE R2!	Displays message to operator on teletype.
PAUSE 6	Program pauses, awaits operator action and prints "PAUSE 6" on CRT display.
IF (6, 64) 460	If specified output pins are high and others are low, program transfers to test 460.
DELAY 50	Generates delay of fifty 100- μ s increments (5 ms).

Actual tests Performance in practice proves the worth of automatic logic-circuit testing. Prior to the introduction of automatic testing in our facilities, we used hard-wired test fixtures for each board to be tested. These fixtures required an average of two weeks to design and fabricate and, although test times were reasonably short (5 to 10 minutes), the lack of significant diagnostic information resulted in troubleshooting and repair times of 20 to 40 minutes.

Conservatively, a 1792 requires only one-tenth the time for preparation and test and one-third the time for troubleshooting as compared with our manual approach.



SPECIFICATIONS

Device Stimuli: PINS: 60 standard, easily expanded in groups of 12 pins, programmable as either sensors or drivers (short-circuit protected). LOGIC LEVELS: Low of < 0.4 V fixed and two highs, each of +1 to +12 V adjustable, higher levels to +28 V available on request.

Power Supplies: +5 V, +15 V, and -15 V, all can be programmed for nominal, +10%, or -10%. Fully programmable supplies also available.

Display: SCOPE: 12-in. with 24 80-character lines; displays alpha-numeric error messages, programmed diagnostic information and operator instructions, and test program during preparation. Program can be prepared, edited, and loaded via scope display and associated keyboard. TELETYPE: Prints out error messages and test program listing and punches paper tape. INDICATOR LAMPS: Display test results.

Control: By test program written once for type of device under test. Program is prepared by use of display scope and associated keyboard and either loaded directly into computer or punched and stored on paper tape and loaded into computer at 300 characters/s by high-speed tape reader. Tests can also be controlled by panel switches, display keyboard, and teletype keyboard to allow changes in stimuli or test conditions and to permit diagnostic analysis.

Program: Written in easy-to-learn GR-originated test language and stored on paper tape or, with optional disc or expanded-core memory, stored in memory. A permanent executive program permits operator to prepare test programs on display and interactively test the device. An autoprogramming translator program stores responses of a known-good device when it is inconvenient to write outputs into test program.

Environment: TEMPERATURE: +10° to +38°C operating. HUMIDITY: 10 to 90% RH.

Supplied: Logic probe, 2 self-test adaptors, teletype paper, paper tape, training course at GR, and acceptance test at customer's facility. STANDARD SYSTEM: Includes computer with 8192 12-bit words of 1.2 μ s-cycle core memory and power-fail option, interface and power-supply units, control panel; teletypewriter with keyboard, reader, and punch; display terminal with keyboard; and high-speed optical tape reader. STANDARD SOFTWARE: Includes operating, programming, and maintenance manuals, and the following programs; editor, translator, operating system, in a single combined interactive system; autoprogramming translator; diagnostic; and computer diagnostic and maintenance.

Disk Memory (optional): A 2315 removable disk pack.

Device Adaptors: Consist of a plug-in unit with access to test system signal lines; ample space provided for special test circuits, if required.

Power: 107 to 125 V, 60 \pm 0.45 Hz; 50 Hz and 220 V or other versions available.

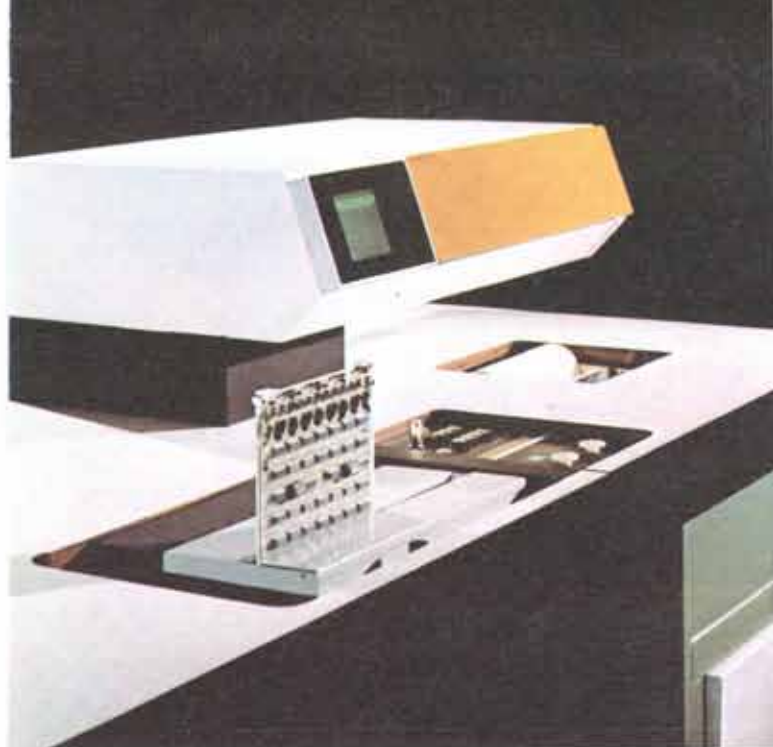

1790 Logic-Circuit Analyzer

- up to 4000 tests per second
- GO/NO-GO tests or complete analysis
- easily-mastered test language
- bright-light, scope-displayed, and hard-copy records
- no reference modules needed
- optional: input checking, marginal testing, additional tape or core memory
- modular design permits adding instrumentation

All the features The 1790 is a computer-controlled functional and diagnostic test system for logic elements, be they simple devices, complex assemblies, or entire instruments. The basic system accepts circuits with 96 inputs and 144 outputs (easily expanded). It performs up to 4000 tests per second and provides scope-displayed, typewritten, and bright-light results of any or all tests — at your command — in terms of a simple GO/NO-GO indication or a detailed account of each test. In many cases, your entire test department can be a single 1790!

Simple setup The flexibility of the 1790 eliminates the need for costly special tooling, test fixtures, and documentation — you need only a test program and a socket appropriate to the device to be tested. For the program, you analyze the circuit and decide how it should be tested, much as you would for a manual test procedure. But, instead of writing an involved test specification, you describe the necessary steps using a unique GR test language — so simple you can learn it in a few hours.

High speed This analyzer is so fast that most test schedules will be limited only by the rate at which devices can be connected to the system. You can be sure of rapid sorting and sufficient time to troubleshoot any defective devices.

Speedy troubleshooting The versatility of the 1790 test language allows a great deal of diagnostic information to be included in the test program. When certain failures are encountered, the program can branch to detailed diagnostic routines and display helpful suggestions or instructions as alpha-numeric messages on the built-in scope. You will appreciate the logic probe (provided) and the provision for external test equipment such as counters, DVM's, and scopes. The mode of testing and the selection of all tests to be executed can be determined at the control panel and teletypewriter keyboard.

An array of all normally used controls is conveniently located near the device under test, grouped for minimum operator fatigue, to ensure high production rates. Push-buttons control all systems operations. They start the test sequence, continue it after a programmed pause or error message, and enable the sequence to be modified by keyboard commands.

Four bright lights Go, Fail, Pause, and Conditional Go, display the results of the test. A Conditional Go indicates the device successfully reached the end of the program, but not all tests were executed. (For example, perhaps a keyboard instruction started the sequence of tests in the middle of the program.)

Device adaptors provide the interface to the device under test (the DUT) and are easily interchanged by the action of a single lever. They are recessed, together with accessory jacks, into the broad desk top that can be used for drawings and auxiliary test equipment. The adaptors include pins for wire-wrapping to a socket for the DUT and for incorporating any additional control or monitoring circuitry or external loads that may be required for the particular device.

A scope, located at a convenient viewing angle, is the primary means of message display. Hard-copy records of error messages and diagnostic suggestions are also available from the teletypewriter at the push of a button.

The high-speed tape reader is used for rapid loading of programs in standard versions of the 1790. In versions with additional memory, a large number of programs can be stored on a tape cassette, rather than on individual paper tapes, and can be automatically loaded on com-



mand. No computer switch manipulation is required in either case; all loading is done by the push of a button or, in versions with the additional memory, by a command entered on the teletypewriter keyboard.

A **teletypewriter** is enclosed under a protective cover that reduces noise and provides additional workspace. The teletypewriter slides out for use in program preparation.

Additional memory (optional) provides over 30 times the normal number of test statements that can be written; up to 30,000 separate statements are possible. Many programs can be stored on a single cassette, and cassettes can be interchanged quickly so that complete test procedures for any one of hundreds of different devices are only a fingertip and a few seconds away.

A human tongue You can prepare test programs in the 1790 test language more simply than you can write manual test procedures. You get more for your effort, too, not only a description of *how* to test your device, but a program that *will* test it. A few statements provide a large number of tests.

SIMPLE TEST LANGUAGE — Typical Statements

*I (1, 2, . . . 17, 23, 24)	Defines number of inputs and identifies pins to which they are connected.
*O (3, 4, . . . 18, 19, 20)	Defines number of outputs and identifies pins to which they are connected.
PS 1 5.08 PS 2 -10.68 PS 3 35.00	(Programmable Levels) Sets power supply voltages.
DR 1 H 4.50 L 0.45 DR 2 H 5.08 L -10.68	(Programmable Levels) Sets each set of input drive levels to device under test.
TH 1 H 4.82 L 0.32 TH 2 H 5.08 L -10.68	(Programmable Levels) Sets each set of sensor thresholds for output from device under test.
IH (1, 2, 17)	Sets specified inputs high, leaves other inputs as they were in previous test.
IL (23, 24)	Sets specified inputs low, leaves other inputs as they were in previous test.
OH (3, 18)	Checks that specified outputs are high and that other outputs are as they were in previous test. With universal device adaptors, also checks inputs.
OL (4, 19, 20)	Checks that specified outputs are low and that other outputs are as they were in previous test. With universal device adaptors, also checks inputs.
SEQUENCE (1, 23, 17)	Generates a sequence of tests with all combinations of the specified inputs.
DO 17, 50	DO loop provides a means of repeating a series of tests; here the loop contains the next test through test 17 and is repeated 50 times.
GOTO 36	Transfers the program to test 36.
IF (3, 4) 31	If specified outputs are high and other outputs are low, program transfers to test 31.
CALL 45	Transfers program to subroutine beginning at test 45. Subroutines enable use of a particular sequence of tests more than once during test program.
IGNORE (4, 18)	Program does not check specified outputs.
PRINT CHANGE IC34!	Displays message to operator on scope.
TYPE REPLACE R2!	Displays message to operator on teletypewriter.
PAUSE 3	Program pauses, awaits operator action, and prints "PAUSE 3" on display scope.
SYNC 2	Generates sync pulse on external line 2.
DELAY 50	Generates delay of fifty 100- μ s increments (5 ms).

Payback in two months Prior to the installation of a 1790 in our facilities, we used hard-wired test fixtures for each board to be tested. These fixtures required an average of 2 weeks to design and fabricate and, although test times were reasonably short (5 to 10 minutes), the lack of significant diagnostic information resulted in troubleshooting and repair times of 20 to 40 minutes.

Conservatively, the 1790 required only one-tenth the time for preparation and test and one-third the time for troubleshooting as compared with our manual approach; these figures are based on several years of experience.

	MANUAL		1790	
	Time	Money	Time	Money
Preparation 50 board types	4000 hr	\$16,000	400 hr	\$1,600
Test 10,000 boards/year	845 hr	3,380	84 hr	168
Troubleshooting and Repair 1,000 rejects/year	333 hr	1,332	100 hr	400
Totals	5178 hr	\$20,712	584 hr	\$2,168

Wages based on \$4.00 per hour except for the 1790 test times that are based on \$2.00 per hour (for relatively unskilled labor).

- 100,000 boards per year of 500 types
- 1000 to 10,000 boards per year of 500 types
- 100,000 boards per year of 100 types
- 100,000 boards per year of 50 to 100 types
- 10,000 boards per year of 100 types
- 1000 boards per year of 100 types
- 10,000 boards per year of 50 types
- 1000 boards per year of 50 types

1 2 3 4 5 6 7 8 9 10 11 12 13 14 15 16 17 18 19 20 21 22 23 24

Payback period in months based on labor savings

Complex circuits no problem The 1790 is in use in our facility as well as in dozens of others where it is busy testing, troubleshooting, and aiding in the design of integrated circuits, LSI arrays, and circuit boards containing over 300 IC's. In the following examples, programming time includes time spent in analysis of the device.

21 inputs, 10 outputs

This board contains an 8-bit accumulator, 8 read-in gates, an 8-bit memory buffer, 2 four-bit full-binary adders, and 8 forty-eight-bit shift registers (40 IC's and 76 other components). Time spent was 16 hours for programming, 16 hours for device-adaptor fabrication (to wire adaptor and construct a special driver circuit), and 400 ms for all 338 test statements.

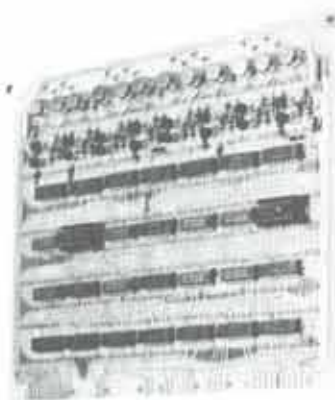

32 inputs, 63 outputs This assembly contains 7 BCD-to-decimal display tubes, 6 ten-position switches, an eight-

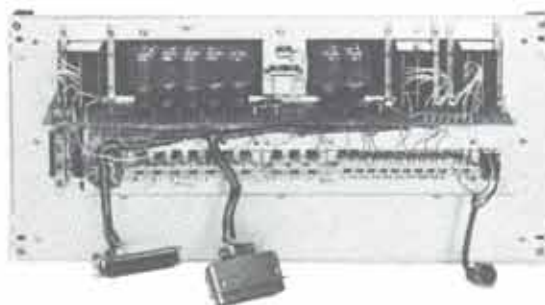

position switch, 24 dpdt pushbutton switches, and a dpdt toggle switch. Time spent was 8 hours for programming, 8 hours for device-adaptor fabrication (to wire adaptor and to construct special cables from adaptor to assembly), and 3 minutes for all 188 test statements, including time for operator to reset controls on assembly according to instructions displayed on scope.

11 inputs, 18 outputs

This board contains decoders, a 3-bit binary counter, a 14-bit shift register with parallel output, and 15 read-in gates (27 IC's and 5 other components). Time spent was 8 hours for programming, 30 minutes for device-adaptor fabrication (to wire adaptor), and 80 ms for all 151 test statements.



— See **GR Experimenter** for January/February, March/June, and July/September 1970.

SPECIFICATIONS

Device Stimuli: INPUTS: 96. Drivers are TTL 7440 power gates. OUTPUTS: 144. Sensors are DTL 944 NAND gates. POWER: +5, +15, and -15 V at 1.25 A max.

Display: SCOPE: Displays alpha-numeric error messages, programmed diagnostic information and operator instructions, and test program during preparation. TELETYPE: Prints out error messages and test-program listing. INDICATOR LAMPS: Display test results.

Speed: 4000 tests/s/pin for 12 inputs and 12 outputs (250 μ s/test), 1100 tests/s/pin for 96 inputs and 144 outputs (900 μ s/test).

Control: By test program, written once for type of device under test. Program is stored on paper tape and loaded into computer at 150 words/s by tape reader or, with optional additional memory, stored with other programs on magnetic-tape cassettes and loaded into computer at 330 words/s. Tests can also be controlled by panel switches and teletypewriter keyboard to allow changes in stimuli or test conditions and to permit diagnostic analysis.

Program: Written in easy-to-learn GR-originated test language and punched on paper tape or, with optional additional memory, recorded on magnetic-tape cassettes, using an Editor program to simplify changes. A Translator program converts test statements to binary form used by the systems and provides a full set of program error messages. An Autoprogramming Translator program stores responses of a known-good device when it is inconvenient to write outputs into test program.

Environment: TEMPERATURE: +10 to +50°C (+10 to +38°C with optional additional memory). HUMIDITY: 10 to 90% RH

Supplied: Logic probe, 2 self-test adaptors; teletype paper, paper tape, 3-day training course at GR, and acceptance test at customer's facility. STANDARD SYSTEM: Includes computer with 4096 12-bit words of 1.2- μ s-cycle core memory, interface and power-supply units, control panel, teletypewriter (including keyboard, reader, and punch), display oscilloscope, and high-speed optical tape reader. STANDARD SOFTWARE: Includes operating, programming, and maintenance manuals, and the following programs: Editor, Translator, Operating System, Combined Interactive System, Autoprogramming Translator, Diagnostic, and computer diagnostic and maintenance.

Additional Memory (optional): Increases test-program length to 30,000 tests for 12 inputs and 12 outputs or 5000 tests for

96 inputs and 144 outputs; consists of 2 magnetic-tape-cassette transports housed in space normally used for storage drawers. Standard Phillips-sized cassettes used, each with 300 ft of tape.

Programmable Levels (optional): INPUT (drive): Two sets of input levels can be set independently by test-program statements from -30 to +30V in 10-mV steps; short-circuit current is 10 to 25 mA and slew rate is typically 2 V/ μ s. OUTPUT (sense): Two sets of output levels can also be programmed independently from -30 to +30 V in 10-mV steps. Outputs can be programmed to either set of sense levels. POWER SUPPLIES (3): Also programmable, one from -20 to +20 V at 2 A max in 40-mV steps, and two from -40 to +40 V at 1 A max in 80-mV steps.

Standard Device Adaptor Kits:

Consists of a frame plus etched-circuit boards containing pins that connect to 1790 inputs and outputs. Pins are wire-wrap connected to sockets



or other connection arrangement for DUT. One version is with holes in 250-mil rows with 125-mil spacing for sockets; the other version is without holes; both are available with 72 inputs and 72 outputs or 96 inputs and 144 outputs. With input and output terminals hard-wired to 1790 drivers and sensors, one standard device adaptor generally accommodates only as many types of devices as there is room for sockets.

Universal Device Adaptors:

Similar to standard device adaptors except many terminals can be programmed as either inputs or outputs by means of simple statements in test program.



Power: 107 to 125 V, 60 \pm 0.45 Hz, 1375 W plus 500 W each for additional-memory and programmable-level options; other voltages and frequencies available.

Mechanical: Console model. DIMENSIONS (wxhxd): 74x48x34 in. (1880x1120x875 mm). WEIGHT: 586 lb (266 kg) net, 824 lb (374 kg) shipping plus 60 lb (27 kg) for additional-memory option.

Description	Catalog Number			
1790 Logic-Circuit Analyzer				
115-V, 60-Hz Model				
115-V, 50-Hz Model				
Select following options, if desired:	(Describe exactly as shown at the left.)			
OP2 Additional Memory				
OP3 Programmable Levels				
OP4 Extra Core Memory (4 k)				
Options available for retrofit in the field, by GR personnel*				
Additional Magnetic-Tape Memory				
3K Programmable Levels				
4K Extra Core Memory (4 k) for PDP-8/e				
Accessories available				
Power Transformer (for line voltage of 105, 210, 220, 230, and 240 V, \pm 8%)	1762-9610			
Standard Device Adaptor				
Socket Holes	Inputs	Outputs	Programmable Pins (In/out)	
No	72	72	No	1790-9601
No	96	144	No	1790-9602
Yes	72	72	No	1790-9603
Yes	96	144	No	1790-9604
Universal Device Adaptor				
No	72	72	24	1790-9605
No	72	72	48	1790-9606
Yes	72	72	72	1790-9607
Yes	96	144	96	1790-9608

* Please consult GR; the nature of your system and its options determines the appropriate software and a choice of variations not detailed here.

1793 Logic-Circuit Tester

The 1793 is the "starter system" of the GR line of logic-circuit testers. With it you gain the economies of rapid digital testing of complex logic circuits at the lowest initial cost.

The 1793 is easily expanded when need and resources dictate. The basic version includes connection capacity for devices with up to 48 input and 48 output pins, push-button control with bright-light annunciators for the operator's convenience, a computer, a teletypewriter, and all necessary programs: Editor, Translator, and Operating system. Diagnostic instructions and other messages can be programmed to reduce troubleshooting time.

Several options are available, initially or later. They include (for faster input and output than afforded by the teletypewriter) a CRT display, high-speed tape reader, and cassette transport. Also, an autoprogramming feature obviates the programming of acceptable output conditions through the initial testing of a known good board. For even more testing capability and extra time-saving options, consider the GR 1790 Logic-Circuit Analyzer.

Test-oriented language The 1793 uses the same high-level test language as the 1790. Test programs are written in the same order as manual test procedures, with commands relating directly to them, for smooth and easy preparation.

Device adaptors are supplied in dedicated and universal versions, including, if you wish, additional control or monitoring circuits or external loads.

Simple setup A quick change of test program readies the 1793 for testing a new device. No costly special tooling, test fixtures, or documentation is required.

High speed Test rates up to 4000 tests per second ensure that throughput in most instances will be limited only by device-handling time. You get fast sorting and gain valuable time for troubleshooting any defective devices.

Operator control is provided by a convenient array of pushbuttons accompanied by bright-light indicators of the test progress and results.

Speedy troubleshooting The versatile 1790/1793 test language permits inclusion of a great deal of diagnostic information for on-line operator instruction, report preparation, or off-line troubleshooting of rejects. A logic probe is a standard accessory. Diagnosis is further enhanced by provisions for connection of external test equipment and by panel control of step-by-step or "test to failure" modes.

Program loading Normally accomplished through the teletype tape reader, this can be speeded up with optional high-speed tape reader or cassette-tape transport. The latter is superior if you wish to store a large number of test programs. Programs are automatically loaded on command from the control panel or keyboard, without manipulation of the computer control.

Instant readout An optional CRT affords instant display of operator instructions and in-process or final test results. You will appreciate it particularly in test-program editing and in troubleshooting of faulty circuits.

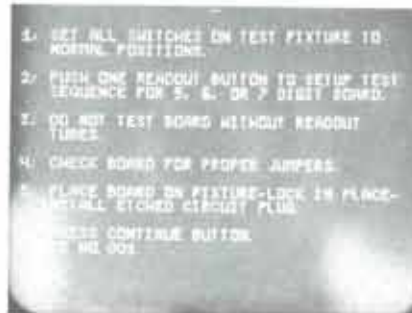
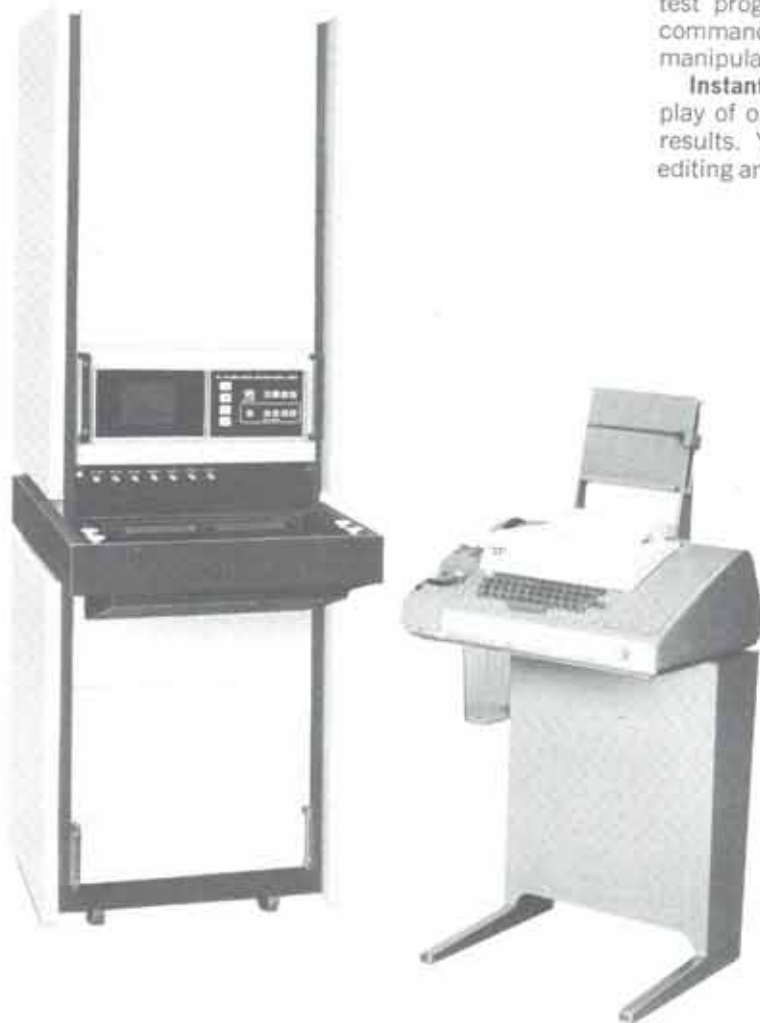

**New Since
Catalog U**



Model 600M Wrapping Station

ComputerWrap™ Wire-Wrapping Systems

- field-proven computer-controlled hardware
- low-cost N/C specifically designed for wire wrapping
- 150 machines on four continents
- thoroughly debugged software

ComputerWrap™ wire-wrapping systems speed the manufacture of circuit boards, mother boards, and back planes by precisely directing the lead selection, routing, and wrapping of circuit wiring. A computer or N/C controller ensures fast, error-free terminal location. The ComputerWrap work stations, of which there are three models, provide the operator with conveniently located status indicators and controls placed for minimal delays. Over two years of proven performance with more than 150

ComputerWrap machines around the world assure you of dependable hardware, versatile software, and responsive, world-wide service back-up.

Three different wrapping station models (the 400, 500, and 600M) are available, two control options (N/C* and direct computer control), and the most extensive software support package in the industry. All station models are identical electrically and in program and function; the computer and N/C controls are plug-compatible. The result of this uniformity is that the same N/C can drive any of the three station models interchangeably, that any combination of station models can be driven from the computer, and that an N/C machine can be converted to a full computer-controlled system in the field.

* Numerical control.

Uncommon features common to all models

- 300-inch/minute operating speed
- twisted-pair capability
- intermediate route point capability
- operator control of zero-set check ("rezero")
- absolute positioning
- unlimited backup
- ability to skip ahead or behind within wire list instantly
- full job controls with unique "out-of-position" light and associated motion inhibit
- all controls and displays at convenient eye level and on the station for maximum efficiency
- full floating zero for minimum setup requirements
- complete program and control interchangeability between all station models
- plug-compatible computer and N/C controls for field upgrading

Model differences The wrapping station models 400 and 500 differ from the 600M in that the latter moves the work panel vertically while the terminal locator is moved horizontally. The 400 and 500 hold the work piece fixed while moving the terminal locator along two axes. The 600M is the preferred machine for large panels as the operator has no up and down arm movement; this model will accommodate panels as large as 36 x 28 inches, with 10½-inch depth, and 400-pound weight. The 500 requires less floor space than the 400 and has an 18 x 18-inch wiring area and 7-inch panel-depth capacity. The 400 will accept a 25 x 38-inch panel of any depth.

The question of computer- versus numerical-control is not easy to answer. Each has its place. If a generalization must be made, computer-control is better suited to large, multi-station installations, while N/C is more economical for one- or two-station installations.

An important and frequently overlooked aspect of automated wire wrapping is the importance of software in tape preparation and modification as well as in operating programs. Many man-years of effort provide our

customers with the best programming backup in the wire-wrapping industry.

More complete information on the software, hardware, service support, and warranty is available on request.



Model 500 Wrapping Station



Computer Control



Model 400 Wrapping Station



Numerical Control

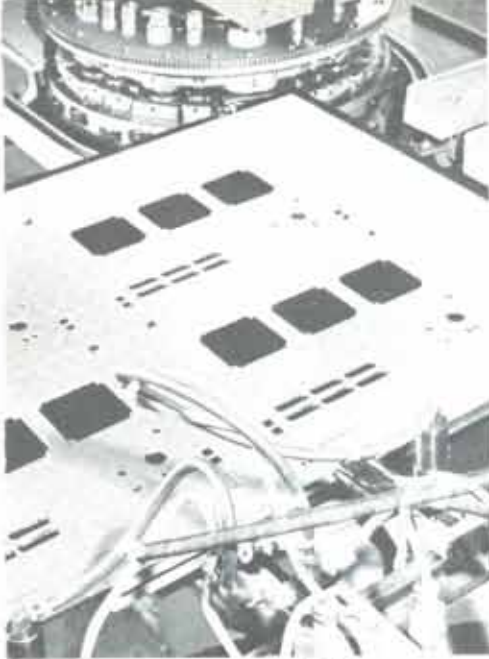

Auto Fab

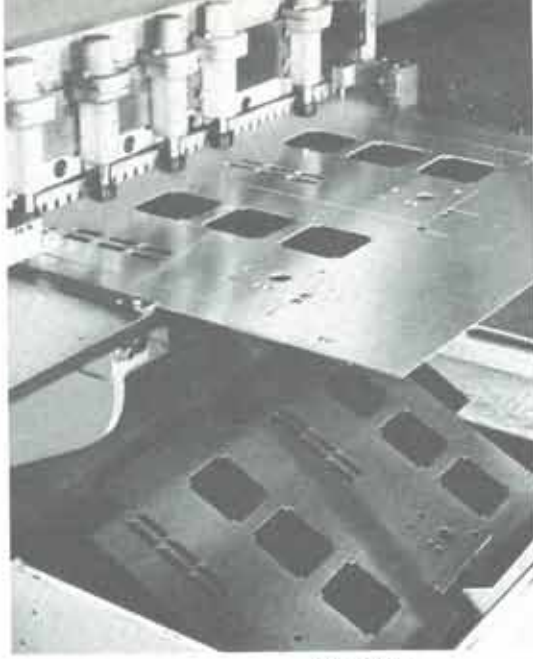

Auto Shear

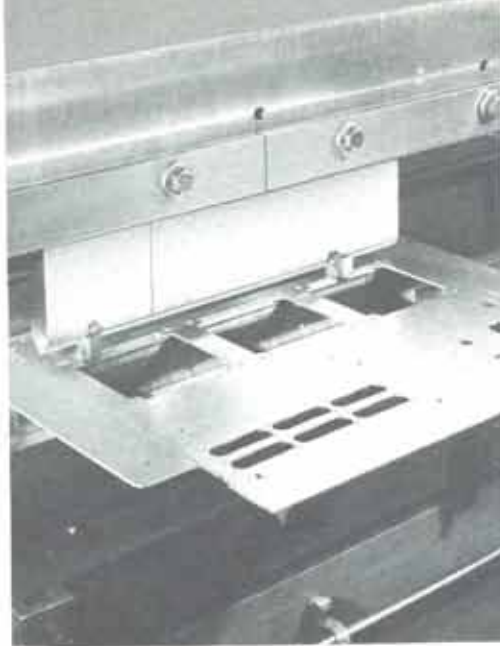

Auto Form

Total Computer Assist to your N/C Sheetmetal Fabrication

Increase profits and be more competitive by pairing N/C with this new computer-aided system

Techware Computing Corporation, a GR company, supplies computer-produced layout drawings, numerical-control tapes, cost and manhour predictions, and tool-life control information. These and many other associated services can save up to 75% in manhours and 40% in turn-around time while doubling the productivity of your sheetmetal fabrication facilities. Savings will be seen in prototype and production stages, in design, manufacturing, and cost accounting.

More competitive bids Sheetmetal parts comprise such a large portion of every electronic system that the costs of sheetmetal design, prototype fabrication, and production will significantly effect the bid price. Furthermore, if parts are not available when needed, the effects can be disastrous, adding to the cost and time required at each stage of the contract's life. Knowing this, bidders traditionally add in enough manhours and time to cover unforeseen costs and delays resulting from sheetmetal problems.

Assuming that competing contractors are equally competent technically, the edge in successful bidding comes from the price quoted. Bids for electronic systems will contain nearly identical material costs. The big variables are manhours and the time required for design, prototype fabrication, and production. If contracts are lost owing to price, then we must analyze these variables and learn how to control them.

Competitive bids will result from a system that introduces speed, economy, reliability, and increased productivity to the development/manufacturing cycle of your products. Techware offers just such a system. With it, you realize:

- low-cost design, drafting, and checking
- accurate and inexpensive prototypes with no delay
- predictions of future costs early in the contract life
- tight control on the costs of expensive special tools
- on-time production release that is reliable and inexpensive
- minimal new-capital requirements
- guaranteed minimum unit cost per manhour with maximum productivity
- high quality without high-cost inspection and quality control

The advantages of computer aid and N/C techniques have been extended by Techware to the shear and power brake so that every step in sheetmetal fabrication can be

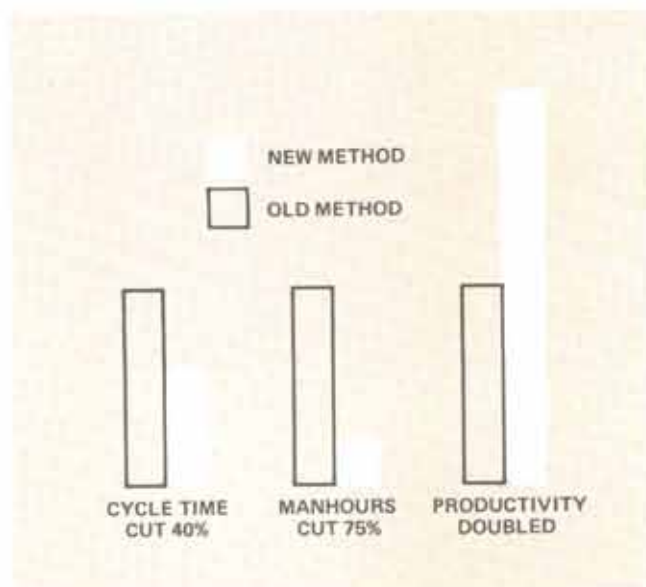

Economic changes achieved by combining N/C with a new computer-aided system for design, prototypes, and production of sheetmetal.

shortened and some even eliminated. The system is so versatile that, for example, several different prototype parts can be fabricated from the same sheet at production efficiency.

Proven Technique Techware's new system has been proven practical at the General Radio plant at Bolton, Massachusetts. Combining the speed and accuracy of the computer with the versatility of N/C equipment, this

method has decreased sheetmetal production costs by at least 3 to 1 each year.

Over the past few years, General Radio has applied this powerful new system to the problems of converting new designs and raw material into finished products—at competitive prices. You can, too.

The bar chart illustrates what has actually been gained at General Radio. We can arrange for you and your people to see this operation at your convenience at GR.

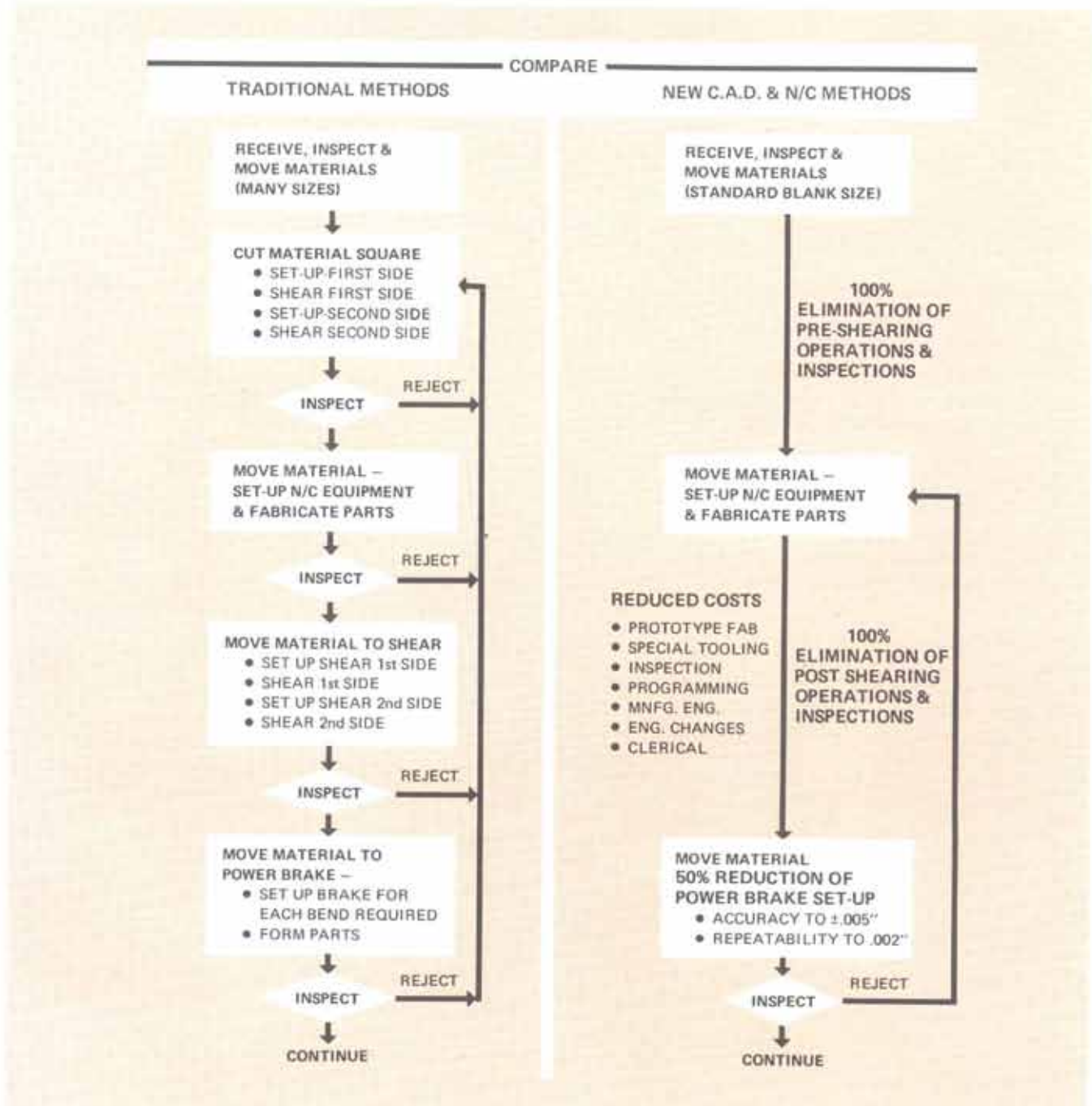

New



M/S 80 Laser Trim System

- functional or resistance trimming with modular versatility
- automatic substrate handling with optional automatic ejection
- up to 12,000 trims per hour to 0.1% accuracy with production-proved YAG laser
- simple setup with interchangeable 48-position probe ring, TV monitor, and simple trim language
- expanded capabilities with optional step-and-repeat probing, reject marking, and cassette memory

Complete versatility The Micronetic Systems Model 80 Laser Trim System is a complete computer-controlled trim system for thick- or thin-film active circuits or passive resistor networks. It is particularly well-suited for use with fully-completed active circuits and can trim to such circuit parameters as ac and dc voltage and current, or frequency, in addition to resistance or resistance ratio.

The system includes a YAG laser, X-Y beam positioner, automatic substrate handler, easily interchangeable probe ring, measurement module, computer, and TV monitor with joystick control. All elements are arranged for efficient operator control.

The low-cost probe rings are equipped with 24 individually adjustable probes, but will accommodate up to 48. Also available to suit your particular requirements are other extras, such as refrigerated closed-cycle laser cooling, step-and-repeat probing, automatic substrate ejection, cassette memory, and reject marking. These can be added at the time of purchase or later as the need arises. Thus, the trimmer suits your application, both present and future, simply and without the cost of non-essential frills.

Precision performance The automatic substrate handler incorporates four nests that accommodate substrates up to 3 in. square or other common circuit configurations and performance boards. The substrates are held against two alignment ears by the vacuum system, to assure precise alignment with the same reference corner used in the printing operation.

Computer control and precise beam positioning provide straight line, L-shaped, serpentine, or other combinations of straight-line trim patterns. A unique edge-seeking feature permits accurate location of the trim even in the absence of accurate printing registration on the substrate.

The entire substrate is probed simultaneously by means of individually adjustable probes located on easily interchanged probe rings. Each ring accepts up to 48 probes that can be simply and accurately set up for each type of circuit to be trimmed. The ring can be left in place and the probes readjusted for the next circuit type or the entire ring can be replaced by another ring whose probes have been pre-adjusted for the new circuit.

A step-and-repeat option simplifies, speeds, and expands the probing capabilities for circuits with repetitive patterns. All probes are Kelvin-wired to eliminate measurement errors due to lead impedances and thus assure highly accurate trims. A driven-guard terminal permits trims in closed-loop configurations without the need to break a resistor chain or to reconnect resistors after trimming.

Cost-cutting efficiency Micronetic Systems laser trimmers pay for themselves within as short a time as one year, while providing trims for less than 0.5 cent each (about half the cost of conventional air-abrasive systems).

This performance stems primarily from the system's over-all speed — the result of a number of engineering achievements. The Q-switched YAG laser permits accurate trims at speeds up to 2 inches per second. Even

faster is the X-Y beam positioning table that directs the spot over the entire substrate at an optimum speed of 8 in./s, with a resolution of 0.001 in. and a repeat accuracy of 0.0001 in. Finally, the measurement module enables decisions in less than 100 microseconds.

To take advantage of the high trim rates and to increase throughput even further, the substrate is probed in its entirety and the multi-position handler allows substrates to be loaded and unloaded while a trim is in process. In addition, with functional trimming, complete circuit compensation usually can be achieved by trimming only a few resistors rather than trimming all of them. Functional trimming also improves yield, eliminates the need for a separate final-test operation, and compensates for wide fluctuations in active-device parameters so that substantial cost savings are possible.

Time-saving simplicity Since a computer controls the entire process, the actual operating instructions are exceedingly simple — you only tell the system what you want, not how to get it. And you converse with straightforward English-language statements, thanks to an exclusive Resistance Trimming Language developed by Micronic Systems.

The computer has ample memory for 15 resistor trim plans. With the optional memory extension, not only can you increase this capacity many fold but you can also store any number of additional trim plans on magnetic-tape cassettes and call them up quickly for each device when needed. A unique coding system used on the interchangeable probe rings further simplifies the operation by automatically calling up the proper program for the device.

An on-line translator allows programs to be prepared and edited on the teletype while production continues. The compiler-level Resistor Trimming Language enables flexible yet concise instructions for each trim. Datalogging is another useful feature and allows any measurement made by the system to be stored and used later in the trim process, as an input to a statistical routine, or as a periodic output on the teletype, high-speed printer, or other I/O device.

Program examples illustrate ease of operation and flexibility of language and system.

NORMAL TRIM R3 is to be trimmed to a final value of 10 k Ω \pm 1.0%. The statements begin by identifying R3 as connected to probes 39 and 48. The first IF statement directs the operation to jump to a reject statement (E) if the initial value of R3 is too high to be trimmed. The second IF statement rejects the resistor if it is too low to be trimmed, and the third directs the operation to the next resistor (R4) if R3 is within tolerance (greater than 9.9 k but less than 10.1 k). The position statement (P) directs the beam to the proper position to begin the trim (100 mils along the X axis from the reference corner and 300 mils along the Y axis). The system is now directed to perform the actual trim in a negative direction until either the cut is 20 mils long or the resistor is 10 k Ω .

The trim plan thus assures no time is wasted trying to trim a resistor that can't be trimmed or needs no trimming, and it assures the cut will not exceed a prescribed maximum length.

```
R3, 39, 48
IF >10.1K, JE
IF <5K, JE
IF >9.9K, JA
P X100, Y300
T=20X, 10K
```

DEVIATION-L TRIM Here the requirements are the same as before except an L-shape is desired rather than a straight cut. The first trim statement (T) directs the laser to remove only one-half the difference (0.50) between the initial measured value and the final value, to a maximum resistance of 10 k Ω or a maximum cut of 20 mils. The second trim statement completes the L-trim by directing the beam to proceed at a right angle until either the cut is 40 mils long or the resistor is 10 k Ω . Thus, by means of a few simple trim statements, the trim plan can direct any combination of straight-line geometries.

```
P3, 39, 48
IF >10.1K, JE
IF <5K, JE
IF >9.9K, JA
P X100, Y300
T=20X, 10K, .5D
T=40Y, 10K
```

EDGE SENSING Again, the requirements are the same as for the normal trim above except a seek instruction (S) has been added. This statement first causes the measurement bridge to measure R3, then sets it to one least-significant bit higher than the measured value. The laser beam is then moved toward the edge of the resistor until the bridge detects an increase in value of the resistor of one least-significant bit, indicating the beam has located the resistor. The position statement (P) merely serves to locate the resistor approximately. Edge sensing is thus a rapid and accurate technique for locating small resistors on substrates where the part-to-part printing registration would not normally be sufficient for such precise positioning.

```
R3, 39, 48
IF >10.1K, JE
IF <5K, JE
IF >9.9K, JA
P X100, Y300
S=10X, 10K
T=20X, 10K
```

RATIO TRIM This trim plan is also similar to that for normal trim, except in this case the resistor is to be matched. A datalog statement (M) instructs the bridge to measure the final value of the previous resistor trimmed and store the value in the R register. The trim statement (T) then instructs the laser to trim until either the cut is 20 mils long or the resistor is 0.333 the value of R2 (any ratio of 3 digits from 0.001 to 999 can be specified). Thus, by use of a simple datalog statement and a slight modification to the normal trim statement, resistors can be easily matched.

```
M=25
IF >10.1K, JE
IF <5K, JE
IF >9.9K, JA
P X100, Y300
T=20X, .333R
```

M/S trim systems are warranted against defects in materials and workmanship for one year from date of purchase.

Description	Catalog Number
M/S 80 Laser Trim System	2250-9780
For Added Capability:	
Cassette Memory Extension	
High-Speed Line Printer	
Refrigerated Laser Cooler	
Automatic Substrate Ejection	
Step-and-Repeat Probing	
Reject Marking	
Replacement Nest , additional	
Probe Ring , 1 normally supplied, 48-probe capacity	
Probe for probe ring	
Laser Lamp , spare	

Resistance Anodize Trimmer System — “MiniRATS”

- accurate, economical tantalum-resistor trimming
- complete — trims and tests
- wide range — 10 Ω to 1 M Ω
- precise — 0.01- Ω resolution, 0.02% accuracy
- fast — 0.5% in 1/2 second



**New Since
Catalog U**

A complete solution The General Radio MiniRATS is particularly useful for design and small-lot production jobs. Despite its economy and small size, the MiniRATS is a complete system that includes an anodizing current supply, measurement bridge, and all necessary control circuitry. The entire installation procedure comprises only making a few connections to your probing device.

Operation is equally simple: Set eight direct-reading lever switches for the desired final resistance value; set three other controls for the anodizing current, pre-trim anodizing voltage, and measurement rate. Half a second later, your resistor is trimmed. With the Kelvin and guard connections, you can trim small values with ease, even in networks with shunt paths.

Front-panel indicators provide a check on the process. One lamp warns of pretrimmed resistance values too high to be processed, another signals when the process is complete, and a meter indicates the anodizing voltage during the trim operation. The anodizing current can also be turned off and the unit used as a precision resistance bridge if need be — simply at the flick of a switch.

The simplified diagram shows the major elements of the MiniRATS and the external probes attached to the resistor to be trimmed (R_x). The measurement probes are shown as closed arrows and are connected for six-terminal guarded-Kelvin measurements. This allows resistors

to be trimmed in closed-delta configurations and thus eliminates the need to break a resistor chain or to bond resistors together after trimming. Unguarded 4-terminal Kelvin connections and simple 2-terminal measurements are also possible.

SPECIFICATIONS

Resistance: 10 Ω to 1 M Ω in 0.01- Ω steps; set by 8 in-line-read-out lever switches.

Accuracy: $\pm 0.02\%$ ± 50 m Ω , from 100 Ω to 100 k Ω ; $\pm 0.1\%$, from 10 Ω to 1 M Ω .

Display: METER: 0 to 250 V, indicates anodizing voltage. INITIAL VALUE LAMP: Lights during pre-trim; extinguishes when oxide-film breakdown reaches from 0 to 100 V as set by rear-panel control; remains lit if initial value is too high for trim. FINAL VALUE LAMP: Lights during trim, extinguishes when final resistance value is reached.

Anodizing Current: 0.01 to 10 mA in ten 1-2-5 steps with compliance voltage to 270 V. Applied for 80% of trim/measurement cycle initially, 20% when resistance is within 2% of final value. Current shuts off automatically when trim is complete or pre-trim value is too high.

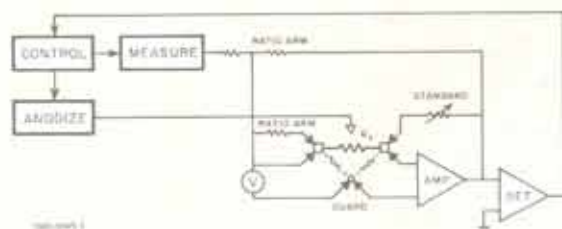

Measurement: RATE: 2 to 41 measurements/s, continuously variable. TERMINALS: 7, i.e., 1 anodizing cathode, 6 guarded-Kelvin terminals. (4-terminal unguarded Kelvin or simple, 2-terminal connections can also be used.)

Supplied: Power cord, two 14-pin type 57 plugs to mate with rear socket for probes.

Mechanical: Convertible bench cabinet. DIMENSIONS (w x h x d): 17x3.88x11.75 in. (432x98x298 mm). WEIGHT: 13 lb (6 kg) net, 18 lb (8.5 kg) shipping.

Description	Catalog Number
Resistance Anodize Trimmer	2995-9349

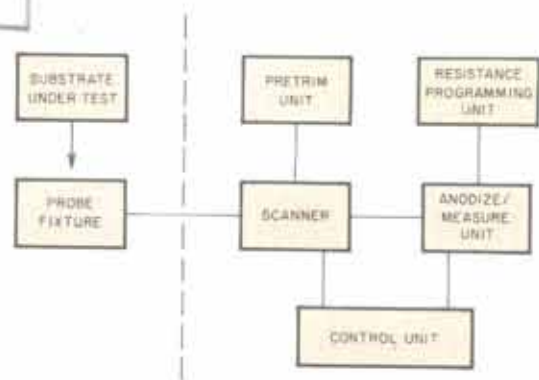
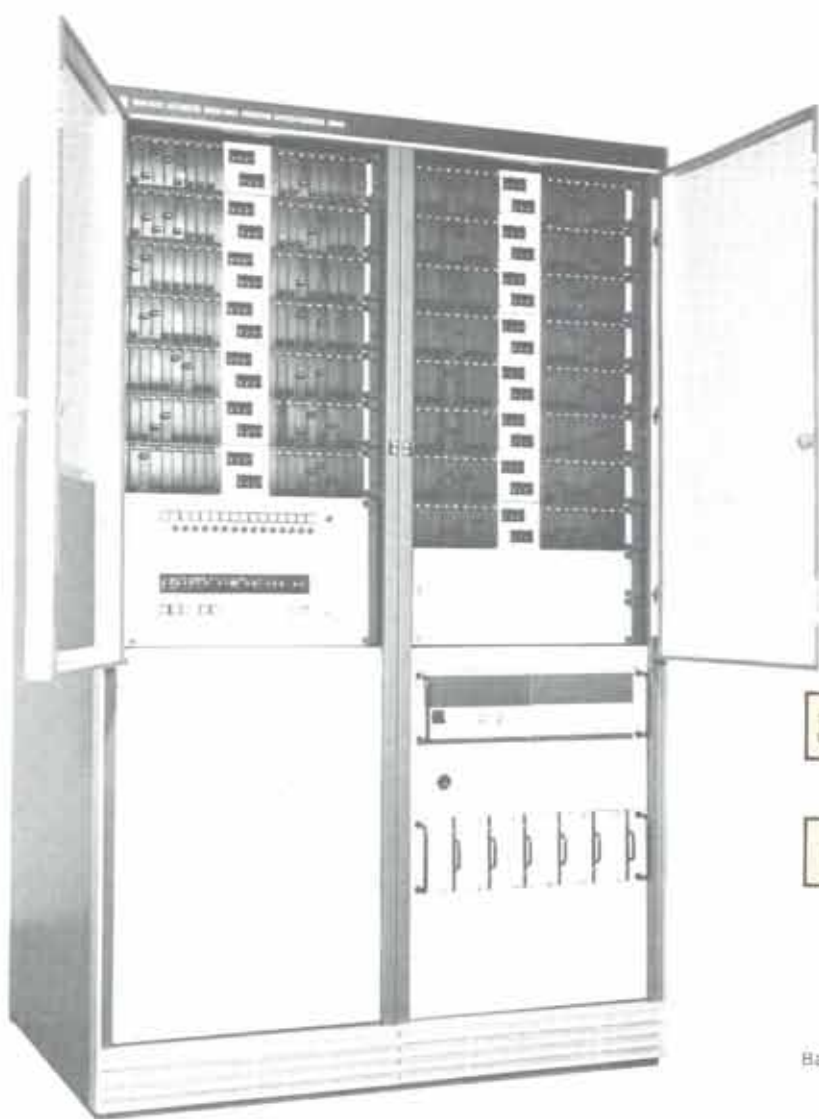

Basic elements of GR "HardRATS" Production Trim System

Production Trim System — "HardRATS"

- **fast** — 30 resistors per second, to 0.1%
- **accurate** — 0.05%
- **efficient** — up to 450 resistors per circuit

For high-volume production trimming of tantalum resistors in multi-resistor circuits, the HardRATS combines the capabilities of 30 MiniRATS units with a common control unit and crossbar scanner. With this *hardwired* control, the system will automatically process, at unsurpassed speed, up to 450 resistors in groups of 30.

The HardRATS includes a crossbar scanner that automatically makes Kelvin connections to the terminals and anodizing cathodes of all 450 resistors. The entire circuit is pre-anodized en masse, by a pre-trim unit, to a specified voltage. Then, in groups of 30, the resistors are simultaneously trimmed, initially at a fast rate, then, after a selected value is reached, more slowly to avoid overshoot. This is done by the Anodize/Measure units, which contain 30 parallel channels, each consisting of a resistance-comparison bridge and anodize-control circuit from the MiniRATS. Resistor values are programmed manually on 30 banks of 8-decade lever switches. On the panel of the Control Unit are operating-condition selectors, indicators of process status, and error-message annunciators.

After being trimmed, the resistors are tested. The system then moves on to the next group of 30.

The HardRATS system multiplies the capacity of the MiniRATS by a factor of 30 with a *much smaller price ratio* and places the 30 channels under control of a single programming unit. HardRATS is the most economical choice for production trimming of large quantities of identical resistance substrates.

SPECIFICATIONS

Trim Channels: 450 in groups of 30.

Scanner Connections: Crossbar with multiterminal connections.

Anodize/Measure Unit: CHANNELS: 30. RANGE: 10 Ω to 1 M Ω . ACCURACY: $\pm(0.03\% \pm 50 \text{ m}\Omega)$ from 100 Ω to 100 k Ω , $\pm 0.1\%$ from 10 Ω to 1 M Ω . TEST VOLTAGE: <1 V dc. ANODIZE CURRENT: 0 to 10 mA. RESOLUTION: 100 μ A. PRETRIM VOLTAGE: 0 to 99 V. TRIM VOLTAGE: 270 V.

Resistance Programming Unit: CHANNELS: 30. RANGE: 0 to 1 M Ω . RESOLUTION: 0.01 Ω . ACCURACY: $\pm(0.02\% \pm 50 \text{ m}\Omega)$.

Control Unit: Thumbwheel switches, push buttons, display lamps, and voltmeter.

Available: Custom configurations, with fewer than standard trim channels or smaller group size.



Computer-Controlled Trim System

New

"RATS" Resistance Anodize Trim Systems

- fast — 12 resistors per second to 0.1%
- accurate — 0.05%
- efficient — up to 240 resistors per circuit
- flexible — resistance values programmable
- easy — user-oriented program language
- complete — trims, tests, logs data

RATS is a totally new computer-controlled system designed from the ground up for high-speed anodizing of tantalum resistors to accuracies up to 0.05%. For noise immunity, RATS is a synchronous system ensuring that no anodizing or switching occurs while a measurement is being made. RATS features modular, plug-in measurement and anodizing units, so you can easily increase the throughput by increasing the number of resistors being anodized simultaneously.

The system normally includes a test station with 12 measurement and anodize-control modules to trim 12 resistors simultaneously, a scanner to process an entire substrate of 240 resistors, a minicomputer, a teleprinter, and a status-control panel.

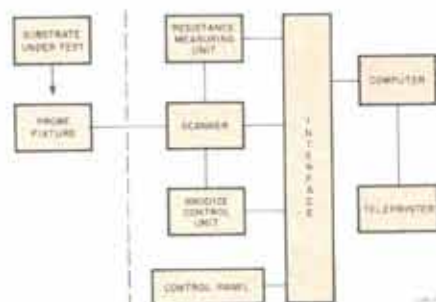

Basic elements of GR "RATS" Computer-Controlled System.

Software programs are written in user-oriented English language for simplicity. An interactive editor/translator program asks the operator for nominal resistor value, anodizing current, and other operating conditions. The trim program is automatically prepared when he types the answers.

Under program control, the system selects a group of 12 resistors, tests them to confirm they can be trimmed to the desired values, anodizes the group to a specified voltage, individually trims the resistors simultaneously, tests them again, and moves on to the next group.

Status and error messages are displayed on the control panel. Data can be logged on the teleprinter for process control and for circuit diagnosis.

SPECIFICATIONS

Trim Channels: 240 in groups of 12.

Scanner: Crossbar with multiterminal connections.

Resistance Measurement Unit: 12 comparison bridges. RANGE: 1 Ω to 1 M Ω . ACCURACY: $\pm 0.03\%$ from 10 Ω to 100 k Ω , $\pm (0.05\% + 10 \text{ m}\Omega)$ from 1 Ω to 1 M Ω . RESOLUTION: 0.01% (14 bits). TEST VOLTAGE: < 1 V dc. COMPARISON TIME: < 2 ms.

Anodize Control Unit: 12 anodize sources. CURRENT RANGE: 0 to 2.4 mA or 0 to 25 mA, programmable. RESOLUTION: 2.5 μA or 25 μA . PRE-TRIM VOLTAGE: 0 to 99 V. TRIM VOLTAGE: 0 to 220 V.

Control Panel: Desk-top type with lever switches and light-emitting-diode displays.

Computer: PDP-8/E.

Core Size: 12k words.

Teleprinter: ASR33 Teletypewriter.

Software: User-oriented programming language and maintenance routines.

Available: High-speed tape reader, dual magnetic-tape unit, alphanumeric programming terminal, step and repeat unit.



New

2230 Passive Test System

Single-or Multi-Station

Designed as a computer-controlled system from the ground up, the 2230 is the passive-measurement section of the Systems 2200 family. It exemplifies best the growth of GR systems. Its measurement components are no longer complete instruments adapted to system use but are measurement *modules designed exclusively for systems use* when this means better performance and lower cost.

The 2230 system can measure and compare the impedance (all forms) of passive components and networks: Ac and dc resistance or conductance, capacitance, inductance, and their associated losses, short-circuit resistance, and leakage conductance.

With its wide capabilities, the 2230 system can measure such diverse component characteristics as diode capacitance, thick- and thin-film network resistance, electrolytic capacitor properties, cable capacitance and resistance, transformer inductance, and various kinds of residual and stray parameters.

Passive plus Because the 2230 is part of the 2200 family, it can operate far beyond its apparent limits. Capability can be easily added to do functional logic testing, analog voltage and current measurements, and a host of other "non-passive" tests.

Family strength The 2230 shares in all the other virtues of the Systems 2200. This system can include one

or more individual test stations under single-computer control. A large number of them can operate simultaneously without interference. The stations can be identical or each dedicated to different specific testing. Yet, because both the hardware and software are modular, the system can be refitted and expanded to assume new testing tasks as the needs arise.

The test-program language is simple and straightforward. Once the necessary tests are determined, the test program is as easily written as the usual manual-testing procedure. The programmer need not be highly experienced in computer techniques; he can devote his full attention to ensuring that the DUT will be given the proper tests. The GR software will ensure that they are executed properly.

The whole system A GR-supplied system is complete. We leave you no unfinished chores, no loose ends. All the peripheral equipment, power supplies, interface units, device adaptors, and programs are included. You can rely on them! Testing details like ground-loop problems, contact closure sequences, and multiple connections (guarded, Kelvin, etc) are all worked out in the scanners and the programs. What's more, we see to it that your GR system keeps operating as you expect it to. We bring you a measurement system you can be proud of.

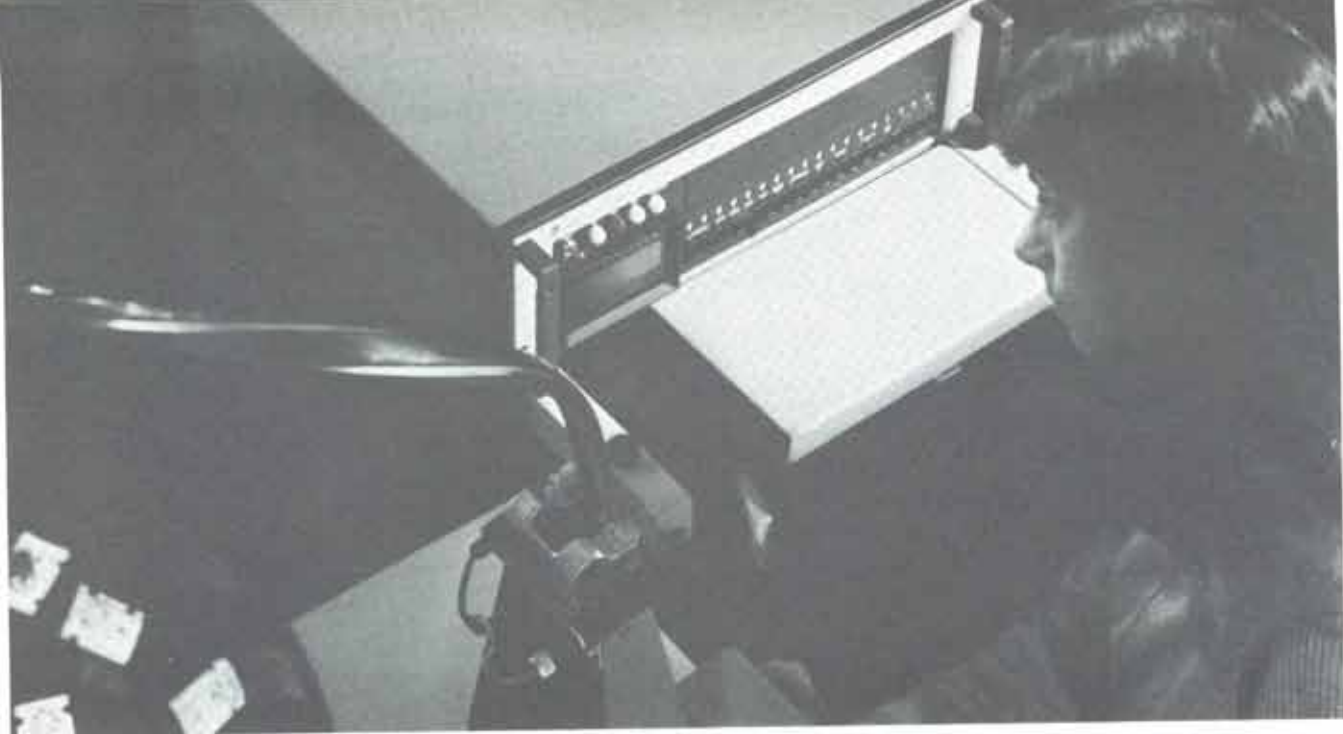

1730 Linear Circuit Tester

**New Since
Catalog U**

- **automatic** — just push a button
- **versatile** — memory panel sets test conditions and limits; no hard wiring
- **fast** — full set of tests in < 2 seconds; faster if you skip tests
- **explicit** — GO/NO-GO results or measured values
- **simple** — adaptable to nearly any device, by you or at GR — op amps, comparators, voltage followers, and regulators . . . linear IC's galore

A versatile performer The 1730 handles with equal ease such diverse applications as circuit evaluation, production testing, and incoming inspection. It provides as much information as desired, from a simple GO/NO-GO indication to a detailed account of each test, from 1 to 18 tests per DUT, at speeds of from 50 to 200 ms per test. Also impressive is the variety of parameters tested: Current, power-supply rejection ratio, maximum output, slew rate, common-mode limit, offset voltage and current, bias current, voltage gain with and without load, common-mode-rejection ratio, output impedance, and gain-bandwidth product.

A universal performer The 1730 is *not* a highly specialized instrument catering to a single circuit type; it tests all common linear circuits, discrete or integrated, including the following:

- single and dual operational amplifiers
- voltage followers
- single and dual comparators
- voltage regulators
- other low-voltage operational amplifiers

Circuits can be tested as fast as they can be connected, and almost continuous measurements of a parameter can be displayed while a circuit under test is in the process of adjustment. For production applications, ask about the available interface hardware for handling and sorting equipment.

One button initiates all tests once the desired conditions have been established. All necessary tests are performed sequentially and automatically on nearly any conceivable type of device, accommodated by means of the versatile device-adaptor scheme used. These adaptors simply plug into the tester and are easily interchanged. They include a universal mating connector for which a variety of sockets is available to fit all common IC packages. Terminals are also provided to install components for compensation or to tailor the adaptor to unique applications. Many device-adaptor boards, completely assembled and ready to use, are available for a large selection of IC's and a comprehensive GR library provides information for the preparation for a host of others.

Three and one-half digits plus decimal point and unit of measurement provide unambiguous, high-resolution results of any or all tests. All data are also available as BCD outputs for use by a printer, card-punch coupler, computer, or other data-handling equipment. Four bright lamps provide GO/NO-GO results of the tests including go, fail, oscillations encountered, and device drawing insufficient current (such as when it is installed improperly). These results, too, are available as electrical signals for use by automatic component handling and sorting equipment.

Eighteen lamps provide indications of specific test failures. If desired, the measured value of the test can also be displayed and, with an auxiliary printer, permanently recorded by the simple flip of a lever switch. In addition to the 17 tests normally provided, another switch



allows any one of four optional pushbutton-selected tests to be performed, including the ripple rejection of voltage regulators, 10-k Ω -loaded gain of operational amplifiers, and any two other custom tests you may need for your particular circuit. A burn-in period can also be introduced after the initial current tests, which provides a one-second interval under power to allow the device junctions to stabilize.

Operation checks are also possible, all in short order and all at the push of a button. All lamps can be checked and all limit settings can be individually read out on the digital display, as can the positive and negative supply voltages. Service, if necessary, is simplified by a set of internal controls that modify the timing and other portions of the normal operation to allow rapid trouble analysis. The upper set of controls is concealed behind a hinged panel to prevent inadvertent tampering; the 18 failure lamps swing out for easy replacement.

Forty switches, conveniently grouped and clearly marked, set all test parameters. The proper tests for any of the six standard device categories are selected automatically by the action of a single slide switch — no separate "performance boards" or other internal circuitry changes are necessary. A seventh position makes provision for any other low-voltage operational amplifiers or similar devices. Available are 19 choices of both the positive and negative power-supply voltages, from 1.5 to 30 V, and five choices for the load, from 150 Ω to 10 k Ω , all by the action of slide switches. External volt-



ages or loads also can be connected. From 38 to 95 limit settings, depending on the parameter, are available for each test, and skip-test and skip-limit settings are included to allow an entire test to be skipped (with a consequent reduction in the total test time) or a limit result to be ignored.

All switches are located on an interchangeable Memory Panel. The switches can be reset for each different type of circuit or they can be left as set and the entire panel exchanged for another, with switches preset for another type of device — quickly and easily without the nuisance and cost of hard-wire programming. Extended-resolution potentiometers can also be inserted to provide infinite resolution of parameters. One value of potentiometer serves for all functions; the potentiometers require no soldering or wiring for installation, and they can be inserted in any or all positions. For systems applications, an option provides complete external electrical control of all parameters.

SPECIFICATIONS

Devices Tested: Device under test (DUT) can be single or dual operational amplifiers, voltage followers, single or dual comparators, voltage regulators, or other low-voltage devices provided for by user. Selected by slide switch on Memory Panel or, with Option 25, by external ground-level signals applied to rear connector. DUT connects to 1730 by means of interchangeable device adaptors.

Test Conditions: VOLTAGE (V_{cc}): + and - 1.5 to 30 V from 2 programmable power supplies, each independently set by slide switches on Memory Panel in 19 steps (1.5, 2, 3, 4, 5, 6, 8, 10, 12, 14, 15, 16, 18, 20, 22, 24, 26, 28, and 30 V), accurate to \pm (1% of reading + 2 counts + 2 additional counts on \pm 150-mA ranges) with internal voltmeter. Can also be set, with Option 25, by external signal of + 5 V for full value. DUT LOAD: 150 Ω to 10 k Ω , set by slide switches on Memory Panel in 6 steps (150 and 300 Ω , 1, 2, 5, and 10 k Ω), accurate to \pm 5%. External load resistor can be connected in parallel with internal 10-k Ω load to rear GR 274 banana jacks. Load is connected for voltage gain and maximum output (tests 6, 11, and 12) only.

Test Procedure: When Start Button is pushed or an external ground-level signal is applied to rear Autohandler connector or, with Option 25, to rear BNC connector, supply voltages are applied to DUT and tests 1 and 2 (+ and - currents) are performed. If currents exceed limits, supplies are turned off and Fail lamp lights; if values are < 5% of limits (such as when DUT is improperly installed), supplies are turned off and Check DUT lamp lights. If currents are within limits, a 1-second burn-in period may be introduced if preselected by a panel pushbutton. During this time, supply voltages are applied to DUT but no tests are performed. If all desired tests are within limits, GO lamp lights; if any limit is exceeded, all tests are completed then Fail lamp lights; if, during any test except 1, 2, 10, and 15, an oscillation of > 200 mV from 1 kHz to 1 MHz occurs, Osc lamp lights. All 4 conditions are also available as ground-level signals at Autohandler connector for use by automatic handling/sorting equipment. Any test can be omitted and any limit can be ignored as selected by Memory Panel slide switches or, with Option 25, by external ground-level signals applied to rear Input connector.

Presentation: MEASURED VALUES: 3 $\frac{1}{2}$ high-intensity neon readout tubes with decimal point and unit of measurement provide visual readout. Information is also available as 8-4-2-1 BCD data is by 4 panel pushbuttons: Off (no data presented), 0 \leq +0.5 V at 3 mA, logic 1 \geq +3.5 V) at rear Output connector. LIMIT RESULTS: GO/NO-GO lamps, see Test Procedure above. LIMIT VALUES: The value of all limits as set by the switches or Extended-Resolution Potentiometers on the Memory Panel, as well as values of V_{cc} , can also be pushbutton selected for display on the visual readout used for the measured values above. SELECTION of parameter displayed or presented as BCD data is by 4 panel pushbuttons: Off (no data presented), Remote (parameter selected by external ground-level signal applied to rear Remote Print Select connector), Failure (failures only presented), or Single (parameter is selected by panel toggle switches, one for each test).

Speed: 600 to 5140 ms depending on device under test and number of parameters selected for test: Up to 2070 ms for single operational amplifiers (18 tests), 4140 ms for dual operational amplifiers (18 tests on each side), 570 ms for voltage followers (8 tests), 830 ms for single comparators (8 tests), 1660 ms for dual comparators (8 tests on each side), and 600 ms for voltage regulators (6 tests), plus 1-s burn-in if selected.

Environment: HUMIDITY: 95% RH at +40°C (MIL-E-16400-4.5.4.6). VIBRATION: 0.03 in. from 10 to 30 Hz. BENCH HANDLING: 4 in. or 45° (MIL-810A-VI). SHOCK: 30 g, 11 ms (MIL-T-4807A-4.5-3A).

Supplied: Power cord, Universal Memory Panel, blank device-adaptor board with universal mating connector plus matching sockets for 14-pin dual in-line (both single and carrier) and 8, 10, and 12-pin TO-package configurations.

Available: Custom systems printers, recorders, card-punch couplers. DEVICE-ADAPTOR BOARDS: 1730-9400 Blank Device-Adaptor Board (one normally supplied), includes universal mating connector but requires socket and wiring for particular device compensation. Complete adaptors, fully assembled including socket and wiring, are available for many common device types and can be built to order for less-common types. Device Adaptor Boards simply plug in and can be easily inter-

Test Summary

Test (Any test can be skipped except tests 1 and 2)	Device *	Time †	Range Full Scale	Accuracy ** % = % of reading % fs = % of full scale	Limits (Any limit failure can be ignored. Limits are set by slide switches or optional extended- resolution potentiometers on memory panel.)
1 Positive Current 2 Negative Current	A F C R O A F C R O	50 ms 50 ms	150.0 μ A to 150.0 mA 4 20-dB ranges	\pm (2% + 1% fs + 15 μ A)	15 μ A to 150 mA in 76 steps (1, 1.2, 1.5, 1.8, 2, 2.5, and 3 thru 15 plus multipliers of X0.01, 0.1, 1, and 10)
3 Offset Voltage	A F C O	200 ms	1.500 mV to 150.0 mV 3 decade ranges	\pm (1% + 1% fs + 20 mV)	0.15 mV to 150 mV in 57 steps (1, 1.2, 1.5, 1.8, 2, 2.5, and 3 thru 15 plus multipliers of X0.1, 1, and 10)
4 Voltage Gain	A C O	200 ms	060.0 dB to 120.0 dB 4 20-dB ranges	\pm 1 dB to 100 dB [‡] \pm 3 dB to 120 dB [‡]	40 dB to 120 dB in 76 steps (21.6, 20, 18.1, 16.5, 15.6, 13.6, 12, 9.5, 7.6, 6, 4.7, 3.5, 2.5, 1.6, 0.8, 0, -0.7, -1.3, and -1.9 dB plus scales of 40, 60, 80, and 100 dB)
5 Offset Current 6 Bias Current	A F C O A C O	200 ms 200 ms	1.500 nA to 15.00 μ A 5 decade ranges	\pm (2% + 1% fs) [‡] + 60 pA	0.15 nA to 15 μ A in 95 steps (1, 1.2, 1.5, 1.8, 2, 2.5, and 3 thru 15 plus multipliers of X0.1, 1, 10, 100, and 1000)
Rejection Ratios: 7 Common-Mode 8 +Power Supply 9 -Power Supply	A A A	200 ms 200 ms 200 ms	060.0 dB to 120.0 dB 4 20-dB ranges	For all tests: \pm 1 dB to 100 dB [‡] \pm 2 dB to 120 dB [‡] (\pm 3 dB to 120 dB [‡] for \pm power-supply tests)	40 dB to 120 dB in 76 steps (21.6, 20, 18.1, 16.5, 15.6, 13.6, 12, 9.5, 7.6, 6, 4.7, 3.5, 2.5, 1.6, 0.8, 0, -0.7, -1.3, and -1.9 dB plus scales of 40, 60, 80, and 100 dB)
10 Output Impedance (Option 11)	A [‡] R O	210 ms	150.0 Ω to 15.00 k Ω , 150.0 m Ω to 15.00 Ω for R* 3 decade ranges	\pm (5% + 5% fs) [‡] + 15 m Ω for R*	15 Ω to 15 k Ω (15 m Ω to 150 m Ω for R) in 57 steps (1, 1.2, 1.5, 1.8, 2, 2.5, and 3 thru 15 plus multipliers of X1, 10, 100, and 1000)
11 +Maximum Output 12 -Maximum Output 13 +Common-Mode Limit 14 -Common-Mode Limit	A C R O A C R O A F O A F O	75 ms 75 ms 75 ms 75 ms	15.0 V and 30.0 V 2 ranges	\pm (1% + 1% fs) [‡] \pm (2% + 1% fs) [‡]	1.5 V to 30 V in 38 steps (1, 1.2, 1.5, 1.8, 2, 2.5, and 3 thru 15 plus multipliers of X1 and 2)
15 Gain-Bandwidth Product (Option 11)	A O	150 ms	1.500 MHz to 150.0 MHz 3 decade ranges	\pm (10%), at 10 kHz [‡]	0.15 MHz to 150 MHz in 57 steps (1, 1.2, 1.5, 1.8, 2, 2.5, and 3 thru 15 plus multipliers of X0.1, 1, and 10)
16 +Slew Rate (Option 10) 17 -Slew Rate (Option 10)	A F O A F O	60 ms 60 ms	0.600 V/ μ s to 060.0 V/ μ s 3 decade ranges (0.2 V/ μ s min)	\pm (10% fs), for a linear slew [‡]	0.06 V/ μ s to 60 V/ μ s in 57 steps (4, 4.8, 6, 7.2, 8, 10, 12, 16, 20, 24, 28, 32, 36, 40, 44, 48, 52, 56, and 60 plus multipliers of X0.01, 0.1, and 1)
18 Optional	Ripple rejection of voltage regulators (200 ms) if Option-1 button is pushed. Light-load (10-k Ω) gain of operational amplifiers (180 ms) if Option-2 button is pushed. Any two other user-prepared or GR custom-engineered tests if Option-3 or Option-4 button is pushed.				1 to 15 in 19 steps (1, 1.2, 1.5, 1.8, 2, 2.5, and 3 thru 15)

* A is single or dual operational amplifiers, F is voltage followers, C is single or dual comparators, R is voltage regulators, and O is other.

** Accuracy is accuracy of measurement, and not that of limit settings. V is test voltage (Vcc).

† When dual devices are being tested, the time is twice that indicated — two sequences are performed, but no pretests are performed.

‡ Accuracy specified down to 10% of full scale.

‡ Accuracy specified down to 20 dB below full scale.

‡ Not all types of amplifiers can be measured for output impedance.

changed. MEMORY PANELS: One 1730-9600 Universal Memory Panel is normally supplied. Memory Panels can be easily reset for each different type of device. EXTENDED-RESOLUTION POTENTIOMETERS: Extended Resolution Potentiometers can be added to any position on Memory Panel so that any or all parameters or limits can be continuously adjusted by potentiometers rather than step-selected by the normal slide switches. Potentiometers are all 20 k Ω \pm 20% and simply snap into the panel; no soldering or wiring required.

Option 10 Slew-Rate Test: Additional circuitry added for tests of + and - slew rates (tests 16 and 17) for operational amplifiers and voltage followers.

Option 11 Output Impedance and Gain-Bandwidth Tests: Additional circuitry added for test of output impedance (test 10) for operational amplifiers and voltage regulators and for test of gain-bandwidth product (test 15) for operational amplifiers.

Option 25 Programmability and Data Output: Two 50-pin type 57 connectors, 6 BNC connectors, and 2 GR 274 banana jacks provide connections for external control-signal inputs and data outputs.

Power: 105 to 125 or 210 to 250 V, 50 to 60 Hz, 100 W max.

Mechanical: Bench or rack models. DIMENSIONS (wxhxd): Bench, 19.56x8.28x24.69 in. (497x210x627 mm); rack, 19x7x16 in. (483x178x406 mm). WEIGHT: Bench, 55 lb (25 kg) net, 85 lb (39 kg) shipping; rack, 47 lb (22 kg) net, 77 lb (35 kg) shipping.



Description	Catalog Number
1730 Linear Circuit Tester	
Bench Model	
Rack Model	
Select following options, if desired	
OP10 Slew-Rate Test	
OP11 Output Impedance and Gain-Bandwidth Tests	
OP25 Programmability and Data Output	
Accessories available	
Blank device-adaptor board*	1730-9400
Universal memory panel*	1730-9600
Extended-resolution potentiometers, set of 3	1730-9599
Extender board, used for maintenance	1730-9598

* One of each is normally supplied.

Automatic Component Testing Systems

In addition to the special-purpose systems on the following pages, there are many component-testing systems more general in their application. Capacitors, resistors, and other components can be measured and tagged or sorted by primary or secondary characteristics, life tested, or measured for drift. The resulting data can be

logged, can be statistically analyzed, or merely displayed for operator instruction.

The systems shown below and on following pages are typical of the breadth of capability that you can expect from General Radio Systems.

A



B

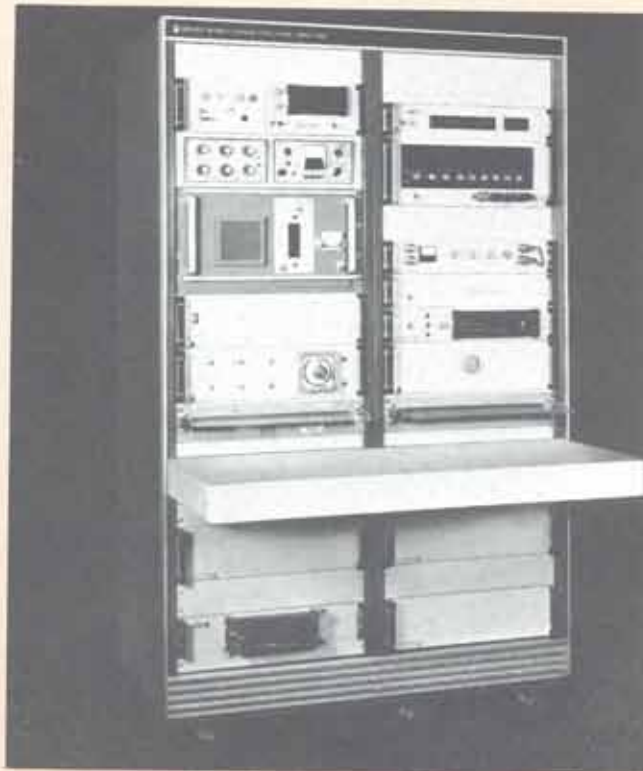

C

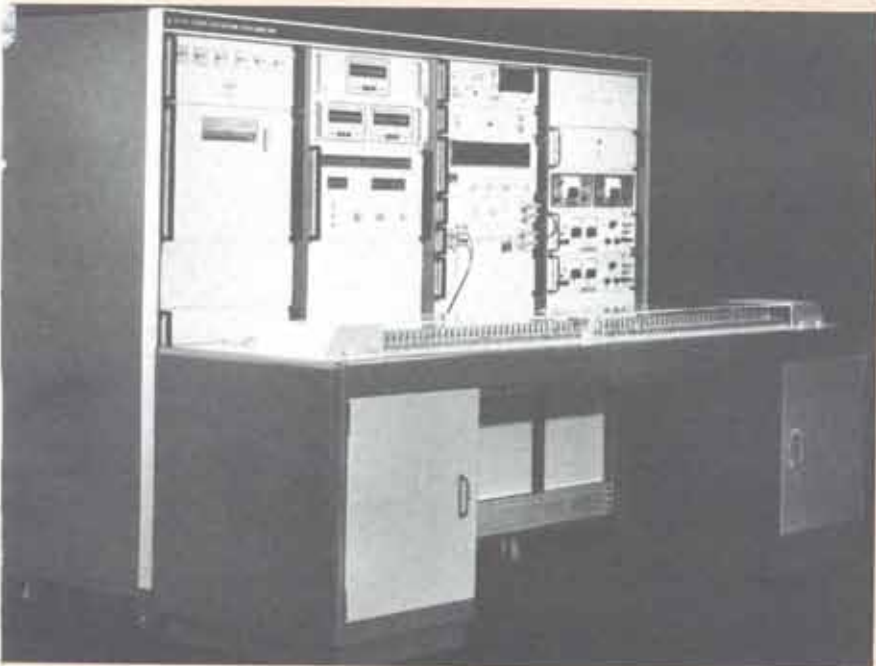

A High reliability assurance for resistors and capacitors calls for computer-controlled drift and life tests with data logging and reduction. Included are 0.1% RLC bridge and digital picoammeter with scanner for up to 50 components, minicomputer and teletype, stimulus supplies, test fixtures, display and interface equipment. Typical price: \$60,000.

B Automatic capacitor sorting to MIL spec tests for hipot, leakage, capacitance, and dissipation factor with classification and failure summaries. System includes automatic handler and sorter, capacitance bridge and digital picoammeter, programming and control equipment, digital limit comparators, stimulus supplies, display and interface equipment. Typical price: \$55,000.

C Production, testing and inspection of capacitors . . . GO/NO-GO decisions and data recording of capacitance, dissipation-factor, and leakage tests. This system includes automatic RLC bridge and digital picoammeter with scanner for up to 50 components, programming and control equipment, digital limit comparator, card-punch coupler, data recorder, stimulus and conditioning supplies, and test fixtures. Typical price: \$40,000.

New

Automatic Leakage-Current Measuring Systems

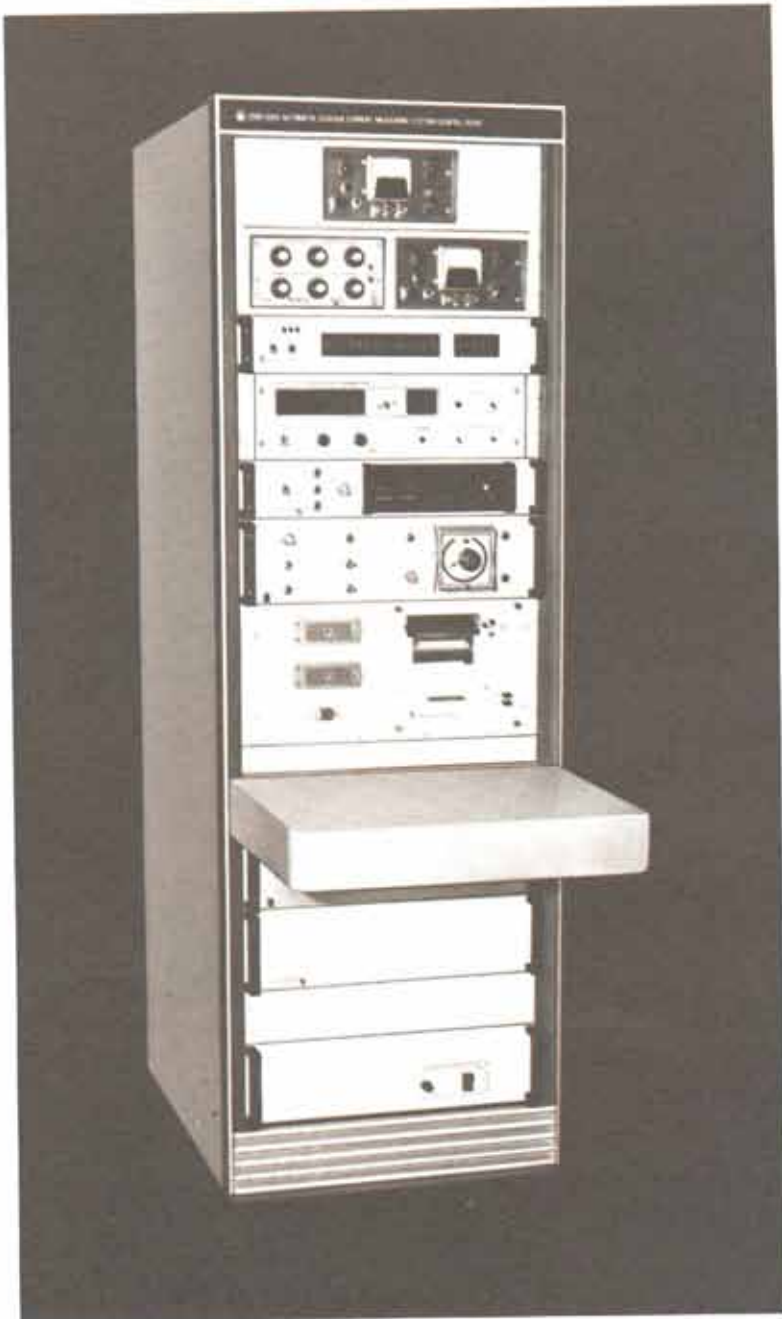

- 50-channel capacity
- electrification voltages up to 600 Vdc
- equal soak time for every capacitor
- automatic GO/NO-GO decisions
- minimum operator involvement

The accurate measurement of capacitor leakage current (insulation resistance) on discrete components and networks presents several problems to both manufacturer and user. Such factors as previous conditioning, accuracy of the electrification voltage, soak time, and measurement time constants can all have significant effect on the accuracy and validity of leakage-current measurement.

Most MIL and other specifications call for the measurement of a capacitor's leakage current after an electrification voltage has been applied to the component for a prescribed length of time. To ensure the validity and accuracy of such measurements, each component must have had the same electrification voltage applied for the same length of time prior to measurement.

Until recently, these considerations have dictated that tedious and time-consuming manual methods be used to measure leakage current (with a megohmmeter and timer, for instance). The possibility of operator error and the certainty of various delays made testing unreliable, uneconomical, and often impractical.

The advent of automatic measuring instruments and systems incorporating these instruments has greatly simplified the task of measuring capacitor leakage current. Today, General Radio offers a complete family of automatic leakage-current measuring systems, from \$14,500, tailored to satisfy your measurement requirements with speed, reliability, accuracy, and economy.

Operator involvement minimized After fixturing and initial settings are complete, one push of a button is all that's needed. Components are automatically connected, charged, measured, and discharged and the measurement data recorded without operator intervention.

Equal soak times guaranteed GR's unique connection and electrification sequence ensures that each component is measured after the same period of electrification.

Operator safety assured Components are automatically discharged after measurement. With GR-designed test fixtures, voltage can be applied to components only after fixturing has been completed.

Automatic GO/NO-GO decisions A digital limit comparator automatically compares measurement data against a preset leakage-current limit and generates a GO/NO-GO decision.

Wide choice of output format Printed hard copy, punched cards, punched tape, etc.

Easy operation With an automatic system from GR, your operator has only to connect the capacitors to the system, select the measurement conditions, and push

a button. All the rest is automatic. Here's how it works.

The system first connects the components to the power supply for electrification in the same order and at the same rate as the measurements will later be made. This ensures that every capacitor is electrified for the same length of time prior to measurement.

At the end of the selected electrification time, the capacitors are sequentially connected to the system picoammeter for measurement. The measured values are automatically compared to a preset leakage-current limit and permanently recorded via an appropriate output device — data printer, tape or card punch, etc. Each component is then automatically disconnected and discharged by the system.

Better quality capacitors, greater throughput, and lower measurement cost all result from a conversion to automatic methods, with improved accuracy, greater speed and convenience.

SPECIFICATIONS

Capacity: Up to 50 channels.

Electrification Voltage: Adjustable up to 600 Vdc.

Electrification Time: Adjustable up to 5 minutes.

Measurement: RANGE: 1.999 nA to 19.99 mA full scale in 8 ranges (1 pA resolution on lowest range). BASIC ACCURACY: $\pm(0.5\%$ of reading + 50 pA).

Speed: Typically 2s per channel, not including soak time.

Options: INPUT: Test fixtures and boards for both axial and radial-lead components. OUTPUT: Various output and data recording devices, including data printers and data couplers for card punch, tape punch, teletype, magnetic tape, etc.

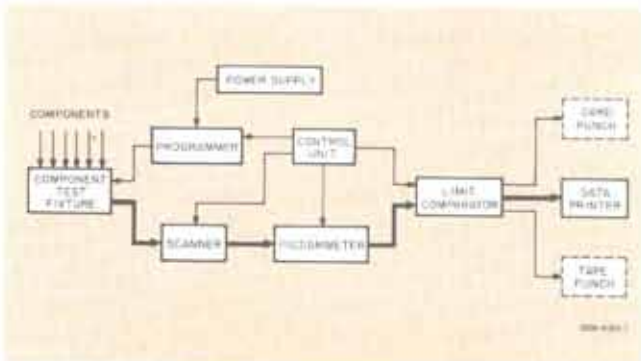

Simplified block diagram of automatic leakage-current measurement system.



Automatic Cable Test System

New

- measures up to 7 parameters — fast
- 100 cable-pair capacity
- on-line report generation
- fully automatic and self-checking
- simplified fixturing

Modern communications systems impose increasing demands on the performance of paired multiconductor cable. To meet these tighter specifications and to guide the manufacturing process efficiently, cable makers are finding it necessary to test more transmission parameters on larger cable-pair samples than ever before. Extensive testing is also required in the design of new types of communications cables.

Manual testing, slow and error prone, is utterly impractical for making so many measurements on such large samples; the results would certainly be costly and unreliable. Consider measuring pair-to-pair capacitance unbalance of a typical 100-pair cable unit to determine the voiceband crosstalk to be expected in service. There are 4950 two-pair combinations in a 100-pair unit. Even if only 20% of these are physically close enough to warrant testing, that requires the selection, connection, and measurement of nearly 1000 pair combinations — a tedious and expensive task.

To automate such measurements, GR offers a family of second-generation computer-controlled test systems, from \$42,500. They simplify and facilitate every step in multiple-parameter testing of telephone cable in a single sequence. You can now test cables to REA and other user specifications at least ten times faster than manually, yet with a thoroughness heretofore impossible. Testing is so rapid that you can readily expand the number and types of tests and save time too. The capability to test automatically more transmission parameters, more rapidly and thoroughly than ever before, assures cable manufac-

turers of meeting stringent user requirements in the most confident and economical manner. Production costs are reduced, while product throughput and quality are increased.

With cable testing systems installed around the world, General Radio demonstrates a continuing commitment to provide the cable industry with the test equipment it needs.

Transmission Parameters Tested

Mutual capacitance This open-circuit parameter indicates the direct capacitive loading of a cable pair on a balanced source. It provides an indication of the insertion loss of the pair and, hence, the transmission efficiency of the cable. Mutual capacitance is defined as the sum of the capacitance C_1 between the two conductors of a pair and the series connection of the capacitances C_2 , C_3 from the conductors to the cable shield (and other conductors). The system measures individually each of the three direct capacitances for each pair in the cable and computes the mutual capacitance.

Mutual conductance This open-circuit parameter also provides an indication of the insertion loss of a cable pair. It is defined as the sum of the conductance G_1 between the two conductors of a pair and the series connection of the conductances G_2 , G_3 from the conductors to the cable shield (and other conductors). The system measures individually each of the three direct conductances for each pair in the cable and computes the mutual conductance.

Capacitance unbalance to ground This parameter indicates the differential loading of a cable pair and provides an indication of its susceptibility to noise pickup. It is defined as the difference between the conductor-to-ground capacitances ($C_2 - C_3$) of the two conductors of a pair, with the cable shield and all other conductors grounded. The system measures this unbalance in a single, differential measurement.

Capacitance unbalance to shield This parameter is similar to unbalance-to-ground capacitance except that C_2 and C_3 are redefined as conductor-to-shield capacitances C_{2US} and C_{3US} with the shield floating. All other cable conductors are grounded.

Pair-to-pair capacitance unbalance This parameter provides an indication of the amount of voiceband crosstalk between cable pairs to be expected in service. It is defined as the capacitance that must be added to (or subtracted from) the capacitance between one conductor of one pair and one conductor of another pair to balance the two-pair network. The system measures this unbalance by subtracting the results of two differential measurements.

Conductor resistance This short-circuit parameter provides an indication of the attenuation introduced by the conductors of a cable and, hence, its transmission efficiency. It is also useful in checking wire gauges. The system measures the resistance of the conductors of each cable pair directly, using Kelvin connections.

Pair resistance unbalance This parameter provides a further indication of a cable pair's susceptibility to crosstalk. The system calculates the resistance unbalance of each cable pair from individual conductor resistance measurements.

Speed, Confidence, and Economy at Every Step

Fixturing simplified You can connect any cable pair to any pair of fixture clips on the GR-supplied fanning fixture. No longer is it necessary to identify pairs by color code and fixture them accordingly, so fixturing time is reduced by as much as two to one; the system's computer identifies the fixtured cable pairs during the testing process. An optional second fanning fixture allows an operator to fixture a second cable while the first is being tested, with a substantial saving in time.

Operator involvement minimized GR provides a test program that requires very little operator intervention.

Simple answers are required to program-generated questions regarding number of cable pairs connected, length of cable, wire gauge, and ambient temperature; this is the extent of the operator's dialogue with the system. A knowledge of computers or programming is not required, and the system can be operated by relatively unskilled personnel.

Connection errors detected The system ensures optimum use of testing time by automatically checking for connection errors at the fanning fixture before performing the parameter tests. Opens, shorts, and split pairs are automatically detected and indicated as error messages (including identification of the pairs involved) on the system teletype. The test sequence will proceed only after the operator has acknowledged or corrected such errors.

Operational check performed The system ensures testing confidence by automatically performing an internal self-check before and after each measuring sequence.

Computer use maximized A dedicated minicomputer is used to full advantage in the GR system. It connects fixtured cable pairs for test in a program-controlled sequence, controls the measuring instruments, performs calculations and corrections on the measurement data, and produces an on-line test report. Speed and accuracy are therefore unmatched by any other cable-test equipment.

Guarded bridge employed GR has based its cable measuring systems on the versatile, well established 1680 Automatic Capacitance Bridge. It uses three-terminal guarded connections, to prevent stray capacitance in the switching hardware, fixture, and connecting leads from affecting the accuracy. The bridge's capability to measure directly a capacitance difference is used to make capacitance-unbalance measurements with greater speed and accuracy than would be possible from individual measurements and computations.

Tailored system test program The highly flexible GR test program will adapt to your existing test procedures and report formats, so the system can be added to your facility without disruption. The system can be easily adapted to test new designs such as aluminum-conductor and low-capacitance cable and to report data in a variety of formats acceptable to both cable maker and user.

Unique features reduce test time GR has developed measurement techniques that allow a 100-pair cable to be fully tested and documented in less than 25 minutes — a job that would require hours with manual equipment — with no compromise in accuracy.

An example of how instrumentation and application knowledge have been effectively combined is shown in the system's pair-to-pair capacitance-unbalance measurement sequence. Usually, only 10-20% of the 4950 two-pair combinations in a 100-pair cable require this measurement, due to their proximity. To save time, the system is normally programmed to test every combination very rapidly for unbalance but to measure only those combinations that are significantly unbalanced. The operator decides what degree of unbalance justifies making a measurement, and can override this skip-test at will. The capability to measure only those combinations that are significantly unbalanced provides for a considerable time saving.

On-line statistical report generated GR uses the system computer to provide a complete, error-free test report summarizing the performance of the cable under

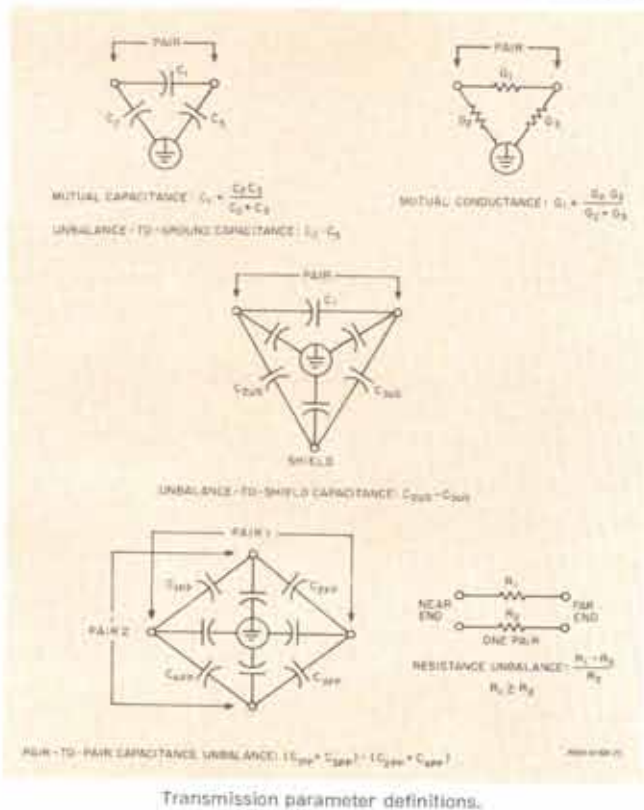

test. This report is generated automatically during the testing process; there is no need for intermediate recording of data on punched tape or cards for later off-line analysis. GR systems give you the report when you need it — while the cable is still connected and available for further testing or inspection. These reports provide a normalized histogrammic tabulation of each parameter, together with the average and standard deviations. The content and format of this report can be tailored to the user's requirements. Such reports can be used to monitor production processes or supplied to a customer as product-test documentation.

Choice of test-report depth A record of all measurement results is often unnecessary in a test report; the GR system can prepare statistical summaries. Three report modes are offered. In the Summary Only Mode, the histogrammic tabulations and statistics for each parameter are recorded. In the Calculated Parameters mode, those and also the final value of each parameter for each cable pair are recorded. In the All Measurements mode, every measured and calculated value of each parameter for each cable pair is also recorded. The latter two recording modes are especially useful for evaluating new cable designs and for training purposes.

Automated troubleshooting GR recognizes the importance of keeping production test equipment on line. These systems are designed and built to GR's usual standards of quality. A versatile maintenance test program is supplied with each system to permit rapid diagnosis of malfunctions, using an effective operator/system dialogue.

Proven techniques, reliability and economy Cable manufacturers have consistently judged GR systems superior in measurement techniques, system design, reliability, and over-all testing economy.

```

IDENTIFICATION DATA
1998-9887 FINAL TEST 04/15/73
PAIRS - 100
WIRE STR 30-1 1
LENGTH FEET 11 450
CONDUCTOR INSULATION PID
TEMPERATURE (DEGREES F) 70

SHORT PAIR 1 0
CORRECTION ERROR IMMEDIATE 1.709 HP
C1 LOW PAIR 10 0.000 HP 0

MUTUAL CAPACITANCE
MUTUAL ERROR PAIR 11 3.400 HP 100.00 HP/FT C
MUTUAL DISTRIBUTION CELL NUMBER AND CELL CENTER VALUE HP/FT
    L  61.0  61.0  65.0  67.0  69.0  71.0  73.0  75.0  77.0  79.0
    0    0    0    0    0    0    0    0    0    0
    81.0  81.0  85.0  87.0  89.0  91.0  93.0  95.0  97.0  99.0
    0    0    0    0    0    0    0    0    0    0

AVERAGE 71.16 HP/FT      COEFF OF VARIATION 0.16 3
STD DEVIATION 1.540 HP/FT  PID LIMIT 0.17 HP/FT
NUMBER OF CELLS 100

RESISTANCE TO SHIELD
PAIR LIMIT 0.700 HP/1500 FT  AVG LIMIT 0.110 HP/1500 FT
UNBAL HIGH PAIR 29 0.201 HP 1.070 HP/1500 FT
DISTRIBUTION TO SHIELD HISTOGRAM CELL NUMBER AND CELL CEN HP/1500 FT
    50  100  150  200  250  300  350  400  450  500
    10  0  0  0  10  0  10  0  0  0
    500  600  650  700  750  800  850  900  950  1000
    0  0  0  0  0  0  0  0  0  0

SOURCE 0.100 HP/1500 FT 10000 (400000)
STD DEVIATION PAIR UNBAL 0.400 HP/1500 FT
NUMBER OF TESTS 100

END OF TEST-TYPE CR TO RESTART
  
```

Typical test report with statistical summaries and distributions of measurements of two cable parameters.

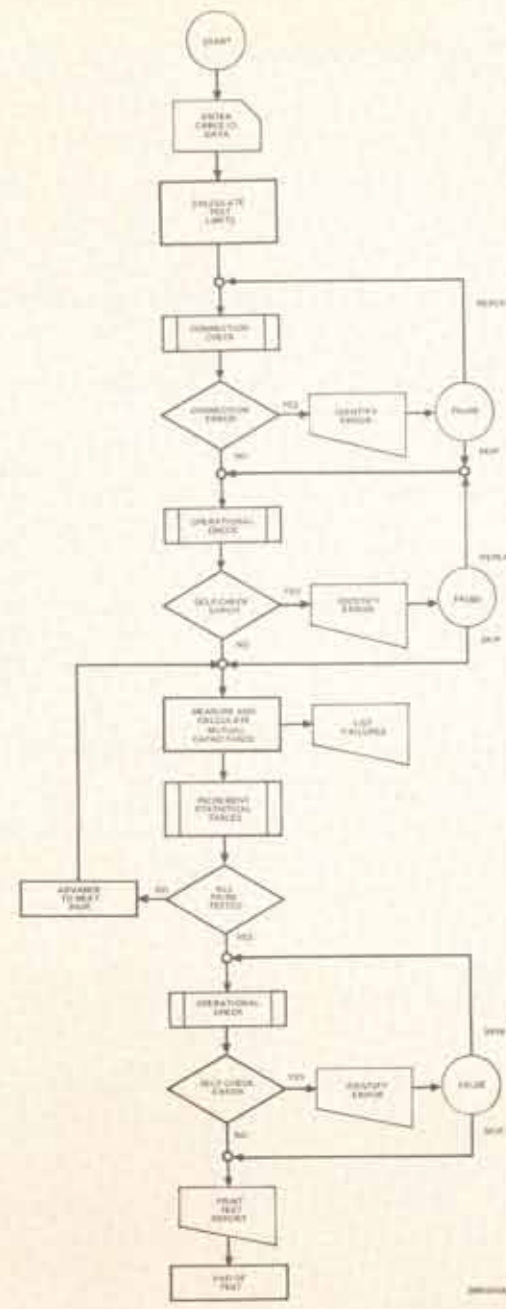

Flow diagram showing a typical test sequence (for measuring mutual capacitance only).

SPECIFICATIONS

Pair Capacity: 100 pairs (single sequence).

Cable Length: 200 to 20,000 ft.

Parameters Measured: MUTUAL CAPACITANCE: Range: 1 nF to 0.5 μF; Basic Accuracy: ± (0.2% + 20 pF). UNBALANCE-TO-GROUND CAPACITANCE or to shield: Range: 0 to 10,000 pF; Basic Accuracy: ± (4 pF + 4 pF / 1500 ft). PAIR-TO-PAIR UNBALANCE CAPACITANCE: Range 0 to 10,000 pF; Basic Accuracy: ± (4 + 0.1 √L) pF. MUTUAL CONDUCTANCE (optional): Range: 0.01 to 100 μt; Basic Accuracy: Depends on mutual capacitance value. CONDUCTOR RESISTANCE (Optional): Range, 1 to 5,000 Ω; Basic Accuracy: ± (0.1% + 20 mΩ). RESISTANCE UNBALANCE (Optional): Range: 0 to 5%; Basic Accuracy: ± 0.2% (absolute).

Test Frequency: Capacitance Parameters: 1 kHz; Resistance Parameters: DC.

Test Time: Typically < 25 minutes for 100-pair test sequence; depends on number of parameters tested and printout mode.



Automatic Transformer Test System

New

- fast multiparameter testing
- easy user-oriented test language
- 12-terminal capacity — expandable
- GO/NO-GO production testing, failure summaries on demand
- up to 16 parameter tests per sequence

Audio-frequency transformers play many roles in today's communications equipment. Beyond their traditional use for impedance matching and isolation, transformers are important components in repeater, tone-encoder/decoder, and pulse-generator circuits.

To ensure dependable in-circuit performance, some or all of the following impedance-related parameters must be tested on multiple-winding transformers:

- inductance
- effective resistance
- inductance unbalance
- transformation ratio
- dc resistance
- capacitance
- continuity

Until recently, multi-station manual testing operations using custom-built bridges were often employed. Transformers were tested for only one or two parameters per station, a procedure causing multiple handling and inefficient product flow.

To eliminate these bottlenecks, GR has developed a computer-controlled system to test all these transformer parameters automatically, in a single test sequence and with only one handling-fixturing operation. It is now possible to test fully a typical transformer in well under 10 seconds.

Decisions are made automatically during the test sequence and GO/NO-GO results are indicated to the operator on color-coded panel lamps.

The ability to test transformer parameters more rapidly and thoroughly than ever before assures manufacturers of meeting their own and their customers' requirements with confidence and economy. Production costs are reduced while product throughput and quality are increased.

System Operation The GR transformer-test system includes a user-oriented software package that simplifies the writing and executing of a test program. GR's SPECTRAN (Specification Translator) program allows a test program to be prepared in a few minutes through use of an operator-to-system conversational dialogue. Operator responses are based solely on the production test specifications for the transformer; no knowledge of computers or programming techniques is required. Once a test program has been generated, GR's UPDATE (User Programmable Dynamic Algorithm for Transformer Evaluation) program is used to exercise the programmed test sequence without operator intervention.

The system measures transformer parameters directly at 200 and 900 Hz with a GR 1683 Automatic RLC Bridge or computes them from a series of measurements. Transformer terminals can be automatically strapped (series connected), Kelvin connections made to each terminal, and any terminal can be guarded, all by program instructions.

While the system is primarily for GO/NO-GO production testing, failures by parameter are also indicated on a display panel. Parameter data for any transformer can be recorded on a teletype at the operator's command; failure summaries are recorded after a prescribed number of tests or on demand.

In this transformer-test system, priced from \$47,500, GR has automated testing operations effectively by skillfully integrating measurement experience with application knowledge to produce a system of great value to the cost-conscious manufacturer.

SPECIFICATIONS

Terminal Capacity: 12 (expandable).

Parameter Tests: Up to 16 per sequence.

Test Frequencies: 200 and 900 Hz.

AC Test Level: Up to 3 V in 0.1-V programmable steps.

DC Bias: Up to 200 mA (20-V compliance), programmable.

Inductance: RANGE: 10 mH to 200 H. BASIC ACCURACY: $\pm 0.25\%$.

Effective Resistance: RANGE: 0.1 Ω to 20 k Ω . BASIC ACCURACY: $\pm 0.25\%$.

Inductance Unbalance: RANGE: 0 to 2%. BASIC ACCURACY: $\pm 0.01\%$ absolute (for unbalance 0 to 0.2%), $\pm 0.05\%$ absolute (0.2 to 2%).

Transformation Ratio: RANGE: 1:1 to 10:1. BASIC ACCURACY: $\pm 0.1\%$ at 1:1, $\pm 0.5\%$ above 1:1.

DC Resistance (optional): RANGE: 1 Ω to 20 k Ω . BASIC ACCURACY: $\pm 0.1\%$.

Capacitance: RANGE: 1 pF to 20 nF. BASIC ACCURACY: $\pm 0.25\%$.

Testing Time: Typically < 10 s, depending on number of parameter tests per sequence.

Automatic Component-Test System

New Since
Catalog U

GR 2990-9259

- 0.1% documented GO/NO-GO tests in half a second
- R: 200 m Ω to 2 M Ω
- L: 20 μ H to 2000 H, plus loss
- C: 0.01 pF to 2000 μ F, plus loss, measured with 0 to 50-V bias
- 5-terminal connections
- test frequency: 120 Hz or 1 kHz
- Push 1 button . . . 50 components measured — complete printout



A universal approach to avoid obsolescence. The 2990-9259 system is universal; it tests resistors, inductors, and capacitors in a variety of applications:

- *For incoming inspection* — decisions and data logging are automatic.
- *For environmental testing* — up to 50 components are mounted on a single test board and tested in less than 30 seconds. They can then be moved to an environmental chamber, conditioned, and returned to detect changes.
- *For quality control* — small- or large-lot samples are quickly evaluated at 120 Hz or 1 kHz.

An integrated approach The system consists of six major units, so successfully integrated that, once the initial measurements are set, one push of a button accomplishes the rest — 50 tested components in less than 30 seconds.

The components are loaded onto a test board and inserted into a test drawer. A scanner connects the components, one at a time, to an automatic RLC bridge for measurement. All connections are five-terminal to preserve the basic 0.1% accuracy of the bridge in the presence of system lead impedances and stray capacitances.

After the bridge completes a measurement, it sends the data to a printer to be recorded. It also sends the data to a comparator that has been previously set with upper and lower limits for the capacitance or inductance value and an upper limit for resistance, dissipation factor or equivalent series resistance. The comparator automatically compares the measurement values to the pre-set limits and promptly gives visual and recorded GO or NO-GO indications of the results.

SPECIFICATIONS

Measurement	Range*		Basic Accuracy*
	120 Hz	1 kHz	
Capacitance, C	0000.1 pF to 1999.9 μ F	000.01 pF to 199.99 μ F	\pm 0.1%
Inductance, L	0200.0 μ H to 1999.9 H	020.00 μ H to 199.99 H	\pm 0.1%
Resistance, R	0200.0 m Ω to 1999.9 k Ω		\pm 0.1%
Dissipation Factor (Concurrent with C)	0.0000 to 1.9999		\pm 1% \pm 0.001
Equivalent Series R (Concurrent with C)	00.001 m Ω to 1.999.9 k Ω		\pm 1%
Leakage Current, optional (GO, NO-GO indication)	2.5 μ A to 25 mA		\pm 2%

* Basic accuracy expressed as percent of reading; full accuracy includes a resolution term that varies with measurement and range. Wider-range impedance measurements possible with reduced accuracy.

Comparison Limits: Upper and lower limits for C and L, upper limit for R, dissipation factor, and ESR. Each limit adjustable from 00000 to 19999.

Display: 4-digit readout plus overrange digit, for reactive and resistive values, with decimal point and unit of measurement; frequency and unbalanced condition also indicated. 2-digit channel indication provided and panel lamps indicate results of comparison.

Speed: 50 components measured in $<$ 30 s, at 1 kHz (rate slightly lower at 120 Hz, depending on differences in component values).

Input: Up to 50 channels scanned sequentially and automatically. Scanner adds $<$ 0.1 pF across unknown and maintains 5-terminal connections to DUT. **FIXTURE:** components under test are mounted on a test board and inserted into a drawer. Axial-lead boards accept components up to 2.5 in. long x 0.75 in. diameter (64 x 19 mm). Radial-lead component boards available.

Test Voltage: 2.2 V rms open-circuit oscillator level. Voltage at DUT dependent upon impedance value and can be reduced.

Bias: 0 to 50 V dc, adjustable in 0.1-V steps; used for capacitance measurements only.

Printout: 14 columns: 2 for channel number, 5 for C or L, 5 for R, D, or ESR, 1 for range (decimal point and measurement units) and 1 for comparison result. Can print all values, in-tolerance values only, out-of-tolerance values only, or out-of-tolerance values in red with in-tolerance in black.

Available: Card- and tape-punch couplers, other component-conditioning, data-processing, and recording equipment.

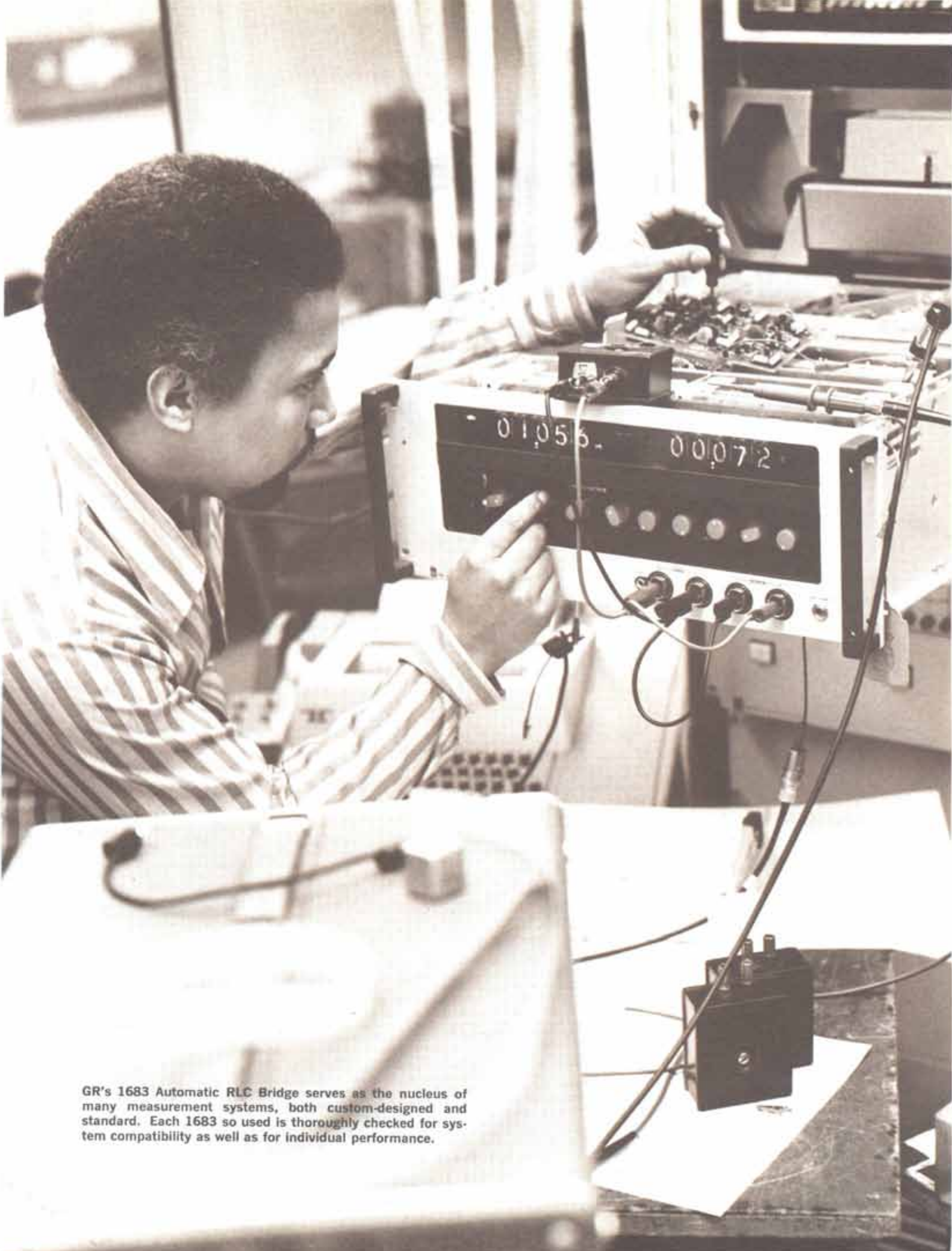

GR's 1683 Automatic RLC Bridge serves as the nucleus of many measurement systems, both custom-designed and standard. Each 1683 so used is thoroughly checked for system compatibility as well as for individual performance.



1683 Automatic RLC Bridge

- Resistance: 1 $\mu\Omega$ to 2 M Ω
- Inductance: 0.1 nH to 2000 H
- Capacitance: 0.01 pF to 0.2 F
- 0.1% basic accuracy
- up to 20 measurements per second

The 1683 Automatic RLC Bridge is a fully-automatic, low-frequency, five-terminal impedance bridge that measures capacitors, inductors, and resistors with loss expressed as a series element. It is a true bridge whose accuracy depends on stable passive standards. The automatic nature of the bridge allows unskilled personnel to make precision measurements at the push of a button.

The accuracy and rapid speed of balance make the 1683 a natural choice for incoming inspection, quality control, and high-volume production applications where a large number of components must be measured in as short a time as possible. The wide range of the 1683 enables it to measure almost any type of component.

The data-output option enables you to retrieve, record, analyze, and utilize volumes of data in a minimum of time. The bridge is designed to interface with scanners, comparators, card- and tape-punch machines, recorders, and computers, all of which can be supplied by GR separately or as a system.

The programming option allows for external control of the bridge functions. This is desirable for fully-automated testing where a master computer may be controlling one or more bridges and other accessory equipment. The computer would function as controller, data retriever, data analyzer, and decision maker to reduce the possibility of error. Such a controlled system would provide for extremely fast, accurate, and economical component evaluation.

The five-terminal feature provides you with the ability to measure accurately low-impedance and high-impedance components far removed from the bridge. The Kelvin-type connection lessens the effects of lead impedance and enables milliohms of impedance to be measured at the end of several feet of cable. The fifth terminal, the cable shield, is used to reduce the effect of stray capacitances on measurements of high impedance. This feature is especially useful when a series of small-valued capacitors is measured in sequence with a scanner system.



The bias feature and leakage option provide the ability to characterize large-valued tantalum- and electrolytic-class capacitors at one station. The equivalent-series-resistance (ESR) option provides you with another means to express loss in capacitor measurements as required by some MIL specifications.

The many features incorporated in the 1683 Automatic RLC Bridge allow you to accomplish fast, accurate, and economical testing of resistors, inductors, and capacitors in a number of applications ranging from laboratory use to the most sophisticated of computer-controlled systems.

— See *GR Experimenter* for March-June 1970.

Measurement	Range		Accuracy (% of reading) ± (% of full scale)
	at 120 Hz	at 1 kHz	
CAPACITANCE With concurrent loss measurement (that can be displayed as dissipation factor or equivalent series resistance) and optional GO, NO-GO leakage-current test.	0000.1 pF to 1999.9 μF 02.000 mF to 19.999 mF 020.00 mF to 199.99 mF	000.01 pF to 199.99 μF 0200.0 μF to 1999.9 μF 02.000 mF to 19.999 mF	±0.1% ±.005% ±1% ±.05% ±5%* (typically 1%) ±0.5%
INDUCTANCE With concurrent loss measurement expressed as series resistance.	00.001 μH to 19.999 μH 020.00 μH to 199.99 μH 0200.0 μH to 1999.9 H	0000.1 nH to 1999.9 nH 02.000 μH to 19.999 μH 020.00 μH to 199.99 H	±5%* (typically 1%) ±0.5% ±1.0% ±0.1% ±0.1% ±0.1%
RESISTANCE Simple resistance, or series resistance with inductance measurements.	00.001 mΩ to 19.999 mΩ 020.00 mΩ to 199.99 mΩ 0200.0 mΩ to 1999.9 kΩ		±5%* (typically 1%) ±0.5% ±1% ±.05% ±0.1% ±.005%
DISSIPATION FACTOR (D) Concurrent with capacitance measurements.	0.0000 to 1.9999 accuracy differs on the following capacitance ranges: 0.2000 mF to 19.999 mF 20.000 mF to 199.99 mF	0200.0 μF to 1999.9 μF 02.000 mF to 19.999 mF	±1% ±0.05% ±1% ±0.5% ±5% ±5%
EQUIVALENT SERIES RESISTANCE (Option 4) Concurrent with capacitance measurements.	00.001 mΩ to 19.999 mΩ 020.00 mΩ to 1999.9 kΩ with C reading of: 03000 to 19999 02000 to 02999 01000 to 01999		±5%* (typically 1%) ±0.5% ±1% ±0.1% ±1% ±0.125% ±1% ±0.5%
LEAKAGE CURRENT (Option 3) GO, NO-GO indication concurrent with capacitance measurement.	2.5 μA to 25 mA in 5 ranges		2% of reading

* In single or variable measurement mode; ±1% of reading plus ±0.1% of full scale in tracking mode.

SPECIFICATIONS

Display: Reactive and resistive readouts, each with 4½-digit resolution, high-intensity neon readout tubes, decimal point, and unit of measurement. Display also indicates measurement frequency, unbalanced condition, manual- or remote-ranging condition, and GO or NO-GO result of leakage current measurement.

Speed: Measurement rate at 1 kHz is = 20 measurements per second for ±1% of full-scale change in unknown, 16/s for ±10% change, and 8/s for ±100% change; at 120 Hz, rates 10 times slower. Interval between measurements can be infinite (measurements initiated by front-panel pushbutton or external closure to ground) or from ≈ 20 ms to 1 s as set by front-panel control so that measurements are repetitive. Speed may be decreased slightly when D is measured near the low end of each capacitance range.

Terminals: Five; 4-terminal connection minimizes errors due to lead impedance and ground terminal minimizes error due to stray capacitance. Connections to unknown are made by coaxial cables at the front and the rear of the instrument. A 1683-P1 Test Fixture is available for the rapid connection of axial-lead components and contains a start button to initiate the measurements. Stray capacitance up to 2 pF across the test fixture can be cancelled by an adjustment on the rear of the 1683.

Ranges: Nine for all measurements except five for leakage current. Ranging can be automatic, manual, or remote except leakage current which has no automatic ranging.

Oscillator Level: Voltage applied to unknown can be reduced from the normal 2.2 V rms for special applications.

Sensitivity: Can be manually or remotely reduced from maximum, with consequent loss of resolution, to overcome problems with non-linear or rapidly changing unknown or external noise or hum pickup.

Bias: 0 to 3 V internal, manually or remotely set; 600 V max, external; 2995-9158 Bias Supply provides up to 50 V and 40 mA. Bridge fully protected from possible damage by charged or shorted capacitors.

Leakage-Current Test (Option 3): NO-GO limit can be manually set with 2% accuracy or remotely measured with 2% accuracy from 1 μA (under vernier control) to 25 mA. External monitoring of leakage current or of a dc voltage proportional to leakage current provided.

Interface:

Low-Level Data Output (Option 5A): 50-pin Amphenol Type 57 connector provides 11 digits of measurement data (5 for reactance, 5 for resistance, 1 for range) plus various control inputs and outputs for systems use. Digits are 1-2-4-8-weighted BCD at standard TTL logic levels (logic "0" = ground with 10-mA sink capability, logic "1" > 3.5 V).

High-Level Data Output (Option 5B): Same as low-level except all outputs are 15-V swing (logic "0" = ground with 10-mA sink capability, logic "1" = + 15 V behind 12 kΩ).

Remote Programmability (Option 2): 50-pin Amphenol Type 57 connector provides terminals for external remote programming of all control functions except line-voltage control. Functions are controlled by closures to ground or standard TTL levels.

Environment: TEMPERATURE: +10 to +40°C operating.

Available: 1683-P1 TEST FIXTURE, 2995-9158 BIAS SUPPLY, printers, recorders, card-punch couplers, scanners.

Power: 100 to 125 and 200 to 250 V, 50-60 Hz, 110 W.

Mechanical: Bench or rack models. DIMENSIONS (wxhxd): Bench, 19x7.88x25.38 in. (483x200x645 mm); rack, 19x7x23.75 in. (483x178x604 mm). WEIGHT: Bench, 60 lb (28 kg) net, 74 lb (34 kg) shipping; rack, 50 lb (23 kg) net, 67 lb (31 kg) shipping.

Description	Catalog Number
1683 Automatic RLC Bridge Bench Model, power freq: 60 Hz Bench Model, power freq: 50 Hz Rack Model, power freq: 60 Hz Rack Model, power freq: 50 Hz	
Select following options, if desired OP2 Remote Programmability OP3 Leakage Current OP4 ESR Readout OP5A* Low-Level Data Output OP5B* High-Level Data Output	(Describe exactly as shown at the left.)
Accessory available 1683-P1 Test Fixture for axial leads	

* Not available together in the same instrument.

Patent Numbers 3,562,641 and 3,227,893.



1684 Digital Impedance Meter

New Since
Catalog U

- automatic RLC measurements
- capacitance: 0.1 pF to 200 μ F
- inductance: 0.1 μ H to 200 H
- resistance: 1 m Ω to 2 M Ω
- 1% basic accuracy
- 4 measurements per second

Triple economy You save 75% of the cost of system bridges when you buy the 1684. You save the time needed to train operators for manual bridges. You save valuable testing time in incoming-inspection and quality-control as well as in the laboratory. There's no better 1% impedance instrument for those spots where speed and total economy matter.

Performance The 1684 does almost everything an impedance bridge is expected to do, does it well, and does it fast and easily.

The 1684 reads out 3½ digits of parallel capacitance or series inductance at 1 kHz and ac or dc resistance (with an option available for dissipation factor as well).

Provisions are included for the application of external bias up to 50 volts and, optionally, for data output to operate limit comparators, for GO/NO-GO tests and sorting, and for data-logging instruments. Six-terminal connections for the unknown device permit use of a Kelvin test fixture or a probe for measurement of in-circuit components.

Solutions The 1684 is versatile. In the laboratory it conveniently measures passive components, mounted or unmounted, with 1% accuracy. For inspection applications, it offers speed for semi-automatic and automatic testing with external sorting and data-logging possibilities.



SPECIFICATIONS

Ranges and Accuracy:

Capacitance: 0.1 pF to 199.9 μ F, parallel, 7 manual ranges.

ACCURACY: * \pm 1% of reading \pm 0.05% full scale \pm 1 pF.

Resistance: 1 m Ω to 1999 k Ω , ac or dc, 7 manual ranges.

ACCURACY: * \pm 1% of reading \pm 0.05% full scale \pm 10 m Ω .

Inductance: 0.1 μ H to 199.9 H, series, 7 manual ranges.

ACCURACY: * \pm 1% of reading \pm 0.05% full scale \pm 1 μ H; when inductor Q > 1.

Dissipation Factor (optional): 0.001 (2000/CL reading) to 1,

1 range. (Note: Min D = 0.001 for C or L reading of 1.999, 19.99, 199.9 or 1999.) ACCURACY: \pm 5% of reading \pm 0.2% full scale \pm 0.001 (2000/CL reading), when C or L reading > 0.199.

Display: 3½ high-intensity neon readout tubes with decimal point; automatically blanked when capacity of range is exceeded. Display normally reads CRL or, optionally, dissipation factor by means of a momentary pushbutton. SPEED: \approx 250 ms per measurement.

Oscillator Level: CAPACITANCE: 5 V pk on 100-pF range, 0.5 V on others. RESISTANCE AND INDUCTANCE: Constant current per range, from 5 μ A for high R to 500 mA for low R.

Bias: 0 to 50 V dc, external only, for capacitors only; applied to rear GR 274 banana jacks; panel switch turns bias on and off.

* For readings > 10% full scale on all ranges except highest impedance (199.9 pF, 1999 k Ω , 199.9 H full scale) where first term is \pm 2% of reading. Temperature coefficient is \pm 0.0072% of reading/°C from 0 to 50°C.

Terminals: 6-terminal guarded connection reduces errors due to lead impedances. **1684-P1** Test Fixture, supplied, provides GR 938 binding posts for connecting unknown device. **1684-P2** Test Fixture with Kelvin clips is available. **1684-P3** Probe provides test leads with clips for in-circuit-unknown connection. Test fixtures and probe plug into GR 274 banana jacks on panel and are easily interchanged.

Environment: TEMPERATURE: 0 to +50°C operating, -40 to +75°C storage. HUMIDITY: 95% RH and +40°C.

Supplied: 1684-P1 Test Fixture, power cord.

Available: 2995-9158 Bias Supply and, if data output is installed, limit comparators, printers, recorders, card-punch couplers, scanners. **Data Output option:** Provides inputs and outputs at rear 36-pin type 57 connector. ANALOG DATA: Proportional to digital value of component at \approx 2.5 mV/count (0 to +5 V for counts of 0 to 1999) and, if **dissipation-factor option** installed, proportional to quadrature loss (Gp, Rs, or Ls); outputs are relative to reference level of \approx 1 V. DIGITAL DATA: 13-line 8-4-2-1 BCD at standard DTL or TTL levels (positive true, logic 0 \leq +0.5 V, logic 1 $>$ +3.5 V) plus closure to ground for range, conversion-complete and overload outputs and blanking and trigger inputs.

Power: 100 to 125 or 200 to 250 V, 50 to 60 Hz, 30 W max.

Mechanical: Bench or rack models. DIMENSIONS (wxhxd): Bench, 12.75x5.63x17.56 in. (324x143x446 mm); rack 19x5.25x13 in. (483x133x330 mm). WEIGHT: Bench, 18 lb (9 kg) net, 25 lb (12 kg) shipping; rack, 22 lb (10 kg) net, 29 lb (14 kg) shipping.



1684-P1



1684-P2



1684-P3

Description	Catalog Number
1684 Digital Impedance Meter, with 1684-P1 Test Fixture, supplied	
Bench Models	
without options	1684-9700
with dissipation-factor option	1684-9701
with data-output option	1684-9702
with D and data-output options	1684-9703
Rack Models	
without options	1684-9704
with dissipation-factor option	1684-9705
with data-output option	1684-9706
with D and data-output options	1684-9707
Accessories	
1684-P2 Test Fixture, Kelvin clips	1684-9600
1684-P3 Probe, for in-circuit testing	1684-9630
Extender Board, used in maintenance	1684-4740



1682 Automatic Capacitance Bridge, 1 MHz

- 0.001 pF to 0.02 μ F
- 0.1% basic accuracy
- 20 measurements per second
- 0 to 100 V built-in bias

Why measure capacitance at 1 MHz? Whatever your reason, you'll find that with the GR 1682 it is as easy at 1 MHz as at much lower frequencies. Use of 1 MHz as the test frequency permits accurate measurement of small values of capacitance in the presence of large values of shunt conductance as found in many semiconductor devices and in rf networks. Many military and commercial test specifications require 1-MHz measurement of small solid-dielectric capacitors, like "ceramics," whose capacitance may vary with frequency.

The 1682 is a true bridge with transformer ratio arms and precision impedance standards for high accuracy and ensured long-term stability. Five-terminal connection for the unknown capacitor minimizes the effects of lead impedances. This is a second-generation automatic GR bridge that is fast and reliable.

The 1682 provides five-digit resolution for capacitance measurements and four-digit resolution for concurrent loss measurements, expressed as parallel conductance. All measurements can be made with internal bias voltages from 0 to 100 V or any external bias voltage up to 200 V. The measuring signal level on unknown capacitors

of <200 pF can be reduced to accommodate voltage sensitive characteristics.

A continuous-tracking mode is provided for voltage- and temperature-coefficient studies. Full programmability is available with an array of inputs and outputs for such enhancements as data printing, card punching, and computer control.



5 Wires for a 2-Terminal Device? Yes! The four-terminal (Kelvin) connections minimize lead-impedance effects and preserve the accuracy of the bridge *at the component* even with low-impedance unknown capacitors. And the fifth, or ground, terminal provides a similar safeguard with high impedances whose measurement might otherwise be affected by stray capacitance to ground.

— See *GR Experimenter* for November-December 1969.

SPECIFICATIONS

Measurement	Range	*Accuracy (% of reading)
CAPACITANCE With concurrent loss measurement displayed as parallel conductance	00.001 to 1999.9 pF	0.2% ± 0.005% fs
	02.00 to 19.99 nF	5% ± 0.05% fs
CONDUCTANCE Concurrent with capacitance measurement	00.01 to 1999 μmS	1% ± 1 count
	02.0 to 19.9 mS	5% ± 0.5% fs

* Specified at the end of a 4-foot cable to unknown.

Display: 5-digit capacitance readout (4 digits on highest range, 0.001 to 20 nF) and 4-digit conductance readout (3 digits on highest range, 1 to 20 mS); each with high-intensity neon readout tubes, decimal point, and unit of measurement. Display also indicates unbalanced condition.

Speed: Measurement rate is ≈ 20 measurements per second for ±10% of full-scale change in unknown, up to 50/s for closer tolerance unknowns, 6/s for full-scale change, and 2/s with range changes. Interval between measurements can be infinite (measurements initiated by front-panel pushbutton or external closure to ground) or from ≈ 1 to 0.02 s as set by front-panel control so that measurements are repetitive. A TRACKING MODE provides continuous balances to monitor changing unknowns.

Terminals: Five-terminal connection that minimizes errors due to lead impedance and stray capacitance to ground are made by coaxial cables at the front of the instrument. A 1682-P1 Test Fixture is available for the rapid connection of axial-lead components and contains a start button to initiate the measurements. A 1682-P2 Test Fixture is available for the connection of GR900® connector-terminated components such as the GR 1405, 1406, and 1407 Coaxial Capacitance Standards. A 1682-P3 Test Fixture is available for the connection of GR 874® connector-terminated components such as the GR 1403 Standard Capacitors or, by means of a 777-Q3 Adaptor, to any component with ¼-in.-spaced binding posts. STRAY CAPACITANCE: Up to 0.5 pF across the test fixtures can be cancelled on lowest two ranges by an adjustment at the rear of the 1682.

Ranges: Four. Top of each range: 20 pF, 200 pF, 2000 pF, 20 nF. Ranging can be automatic, manual, or remote.

Oscillator Level: Measuring voltage applied to the unknown C can be reduced from the normal 500 and 50 mV rms on the lower two ranges to 50 and 25 mV, with a 1-digit resolution loss, for special applications. Can also be factory modified, at additional cost, for a 1-V rms test voltage on lower two ranges (<200 pF) for conformance to MIL C55681.

Sensitivity: Can be manually or remotely reduced from maximum, with consequent loss or resolution, to overcome problems with nonlinear or rapidly changing unknowns, or external noise or hum pickup.

Bias: 0 to 100 V internal, source impedance 100 kΩ, manually set; 200 V max external through 100 kΩ; 2995-9158 Bias Supply provides up to 50 V and 40 mA. A BNC connector is provided to monitor the level.

Interface: LOW-LEVEL DATA OUTPUT: 50-pin Amphenol Type 57 connector provides 10 digits for measurement data (5 for capacitance, 4 for conductance, 1 for range) plus various control inputs and outputs for systems use. Digits are 1-2-4-8-weighted BCD at standard TTL logic levels (logic "0" = ground with 10-mA sink capability, logic "1" = +3.5 V). HIGH-LEVEL DATA OUTPUT: same except all outputs are 15-V swing (logic "0" = ground, with 10-mA sink capability, logic "1" = +15V behind 12 kΩ). REMOTE PROGRAMMABILITY — OPTION 2: 50-pin Amphenol Type 57 connector provides terminals for external remote programming of all control functions except bias and line-voltage control. Functions are controlled by closures to ground or standard TTL or DTL signals.



1682-P1 Test Fixture for axial-lead components



1682-P2 Test Fixture with GR900® terminals



1682-P3 Test Fixture with GR874® terminals

Available: 1682-P1, -P2, and -P3 TEST FIXTURES, printers, recorders, card-punch couplers, limit comparators. Extender boards are useful for servicing the bridge.

Power: 100 to 125 and 200 to 250 V, 50-60 Hz, 60 W.

Mechanical: Bench or rack models. DIMENSIONS (wxhxd): Bench, 19x7.88x24.75 in. (483x200x628 mm); rack, 19x7x23.13 in. (483x178x588 mm). WEIGHT: Bench, 59 lb (27 kg) net, 74 lb (34 kg) shipping; rack, 50 lb (23 kg) net, 67 lb (31 kg) shipping.

Description	Catalog Number
1682 Automatic Capacitance Bridge (1 MHz)	
Bench Model	
Rack Model	
Select following options, if desired	(Describe exactly as shown at the left.)
OP2 Remote Programmability (not available without option 5A or 5B)	
OP5A* Low-Level Data Output	
OP5B* High-Level Data Output	
Accessories available	
1682-P1 Test Fixture, for axial leads	1682-9601
1682-P2 Test Fixture, GR900® terminals	1682-9602
1682-P3 Test Fixture, GR874® terminals	1682-9603
Extender Board	4215-2700
Extender Board (2 req'd)	4215-2701

* Not available together in the same instrument. Patent Numbers 3,562,641 and 3,227,893.

GR System Components

System performance depends as much upon a few nearly "anonymous" component instruments as it does upon the precision bridge or DVM that actually does the measuring. Knowing this, GR has designed and built many ancillary system components to ensure that we can meet your expectations for system performance.

Scanners must make and break many, often complex, connections at high speeds — GR scanners do. GO/NO-GO decisions depend on comparators that are fast and

accurate — GR comparators are. Data interface to card and tape punches, teletypewriters, and computers must be fast and unobtrusive — GR couplers excel.

Put these "anonymous" ones together with GR automatic measuring instruments and a judicious selection of peripherals and you have a system for which GR is proud to take full responsibility — a dependable system that will easily pay its own way in your operation.

Scanners

Measuring systems, perhaps more than any others, must be capable of rapidly changing many complex connections, particularly between the device-under-test and the test equipment. Program-controlled scanners serve this function, and GR has over 30 different configurations of scanners to suit a wide variety of measurement demands.

GR scanners can switch single- or multiple-contact lines to establish, for example, Kelvin connections to the DUT. Scanner boards are available which will switch high-voltage and high-current lines without difficulty.

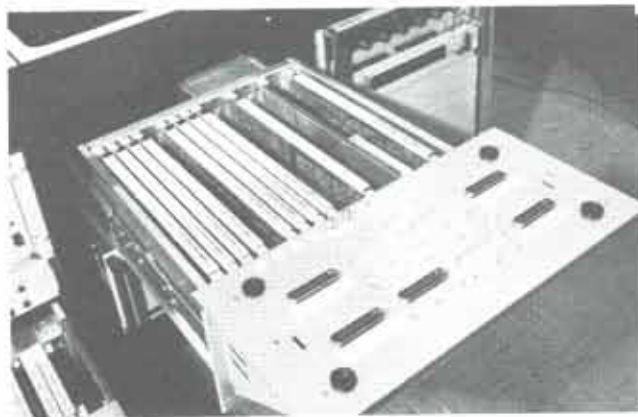

Computer-controlled scanner boards in Systems 2200.



Series 1770 Scanner showing manual controls.

Lines shielded for high isolation or for high frequencies can be handled by GR scanners without loss in performance. Guarded connections are preserved through the scanners for measurements that are independent of stray capacitance and leakage.

Some GR scanners (the 2201 series) are intended expressly for computer control. They are assembled on circuit boards that are fully interchangeable, thus permitting the system to keep pace with changing requirements. Other scanners (the 1770 series) are automatic. They can be controlled manually or by external programming. Up to 100 channels can be selected either randomly or sequentially. Sequential selection can be stepped between preset limits on command or periodically with selected step rate and dwell time.

Digital Limit Comparators

GO/NO-GO or multiple-category sorting of components depends on decisions. In product-sorting systems, decisions need to be fast and accurate.

GR offers a family of digital limit comparators to fill that need. The 1781 and 1783 are typical of the family; 5-digit limits on two independent parameters are set on front-panel thumbwheels.

With 5-digit capacity, these comparators add no uncertainty to 0.1%-accurate measurements.

Using BCD outputs of the pertinent measuring instrument, the comparator displays a GO light or a NO-GO light



1783 Digital Limit Comparator

(with information on which limit has been exceeded) and closes a corresponding relay contact for operation of the sorters, displays, or recorders in your system.

Several comparators can be used together for multiple-tolerance sorting.

1785 Digital Printer

Permanent printed records—economically This printer provides a precise, compact, and economical means of recording 8-4-2-1 BCD data in permanent printed form and is an excellent companion instrument for GR digital instruments. It can be equipped either with a DTL/TTL input compatible with integrated circuits or with a 15-volt logic input (buffered) useful with RTL circuitry.

Records of up to 21 columns are produced in black or red ink as selected electrically—a unique feature that allows, for example, in-tolerance values to be printed in black and out-of-tolerance values in red. The 1785 also boasts a floating decimal point, a large selection of characters, input cables to tailor it to several GR instruments, and buffered input modules to reduce data-source loading.

For special applications, please consult your nearest GR regional office.

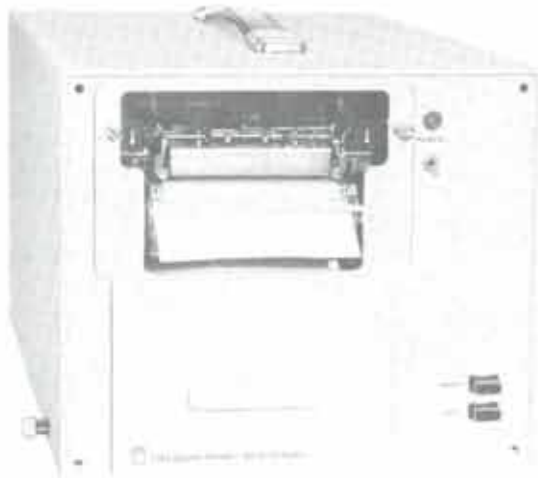

SPECIFICATIONS

Printout: CAPACITY: 21 columns, floating decimal point selectable in any of 9 columns, 7 horizontal characters per in., 5 vertical lines per in. RATE: 3 lines per in., asynchronous. CHARACTERS: 0 thru 9 and *, >, <, , . . . and - in first 19 columns, Z, Y, X, W, db, %, μ K, μ , P, C, d, n, m, K, M, and G in column 20, and m, l, g, P, B, -, F, Ω , S, M, H, c/s, Hz, W, A, and V in column 21. COLOR: Red or black selected electrically, adding-machine ribbon. PAPER: 3.5-in. wide, internally stored, roll or fan-fold; single- and multiple-copy pressure-sensitive paper available.

Interface: DATA INPUT: 4-line 8-4-2-1 BCD at standard 5-V levels (logic 0 \leq +0.4 V at 3.2 mA max sink, logic 1 = +2.4 to +5 V or open circuit); 15-V 8-4-2-1 or 2-4-2-1 logic is compatible with buffered modules (optional) only. CONTROL: Print-command input is 10- μ s positive or negative pulse or dc-coupled transition from logic 1 to logic 0 (6 mA max sink). Busy-signal output is logic 0 to inhibit data source during 330-ms print cycle.

Power: 105 to 125 V or 210 to 250 V, 50 to 400 Hz, 50 W.

Mechanical: Portable or rack models. DIMENSIONS (wxhxd): Portable, 8.5x7.75x14.5 in. (216x197x368 mm); rack, 19x 8.75x13.25 in. (483x223x337 mm).

Description	Catalog Number
1785 Digital Printer	
Portable Model, DTL 8-4-2-1 Input	1785-9701
Rack Model, DTL 8-4-2-1 Input	1785-9702
Specify 1 or more of following essentials:	
Input Cable for 1680 Bridge	1785-1000
Input Cable for 1682 or 1683 Bridge	1785-1010
Input Cable for 1926 Detector	1785-1020
Mating Connector Assembly (unwired, for use with other data sources)	1785-0427
Select following options, if desired:	
Buffered Input Module, 8-4-2-1	1785-9601
Buffered Input Module, 2-4-2-1	1785-9602
Accessories Available:	
Paper, Roll (pack of 10)	1785-0425
Paper, Fan Fold (pack of 10)	1785-0428

Couplers

Total-system attention at GR means not only versatile adaptors to the DUT and assured compatibility among system components but also high-performance interfacing with devices that may not be supplied but which must operate with the system. Typical of this capability is the GR 1791 Card-Punch Coupler which enables any GR system to output data to an IBM 526 card punch.

The 1791 accepts up to 22 digits of binary-coded digital data in parallel form from one or more sources. It converts the data to serial 10-line-decimal contact closures as required by the card punch.



1791 Card-Punch Coupler

SPECIFICATIONS

Input: Twenty-two 2-4-2-1 or 8-4-2-1 BCD digits. Logic "0": -8 to -50 V; logic "1": 0 to -2 V, with respect to a reference level that can be \pm 50 V from chassis ground.

Output: 10-line decimal via reed-relay contact closures.

Speed: Determined by the associated punch.



2995-9158 Bias Supply

- 0 to 50 V, up to 40 mA
- programmable

This supply provides a bias voltage adjustable from 0 to 50 volts in increments as small as 0.1 volt. (Several supplies can be used in series to permit a combined bias voltage up to 150 V.) Voltages can be remotely programmed or manually set, and a panel meter serves to indicate the output level. The 2995-9158 also protects the measuring instruments and handling equipment from large current surges (as from a charged or shorted capacitor inadvertently connected for measurement) by instantaneously limiting the current.

An additional feature of this bias supply is the very low series impedance it presents to the bridge test signal. Thus, under most conditions, the bridge readings are valid without correction for that impedance.

SPECIFICATIONS

Voltage: 0 to 50 V, adjustable in 0.1-V increments with 3 in-line-readout dials.

Accuracy: $\pm(0.2\% + 10 \text{ mV})$ typical. **STABILITY:** $\pm(0.1\% + 1 \text{ mV})$ typical for 8 h. **REGULATION:** $\pm(0.2\% + 10 \text{ mV})$ from 100 to 125 V ac line. **RIPPLE:** $< 100 \mu\text{V rms}$.

Current: 40 mA positive, 10 mA negative. Transient current limited to $< 100 \text{ mA}$ within $2 \mu\text{s}$.

Impedance: $< 0.2 \Omega$, up to 1 kHz; added 3-terminal capacitance, $< 1 \text{ pF}$. **LIMIT IMPEDANCE:** $1 \text{ k}\Omega + 100 \Omega/\text{V}$.

Programming: 100 Ω/V , connected between two rear-panel connectors.

Environment: **OPERATING TEMPERATURE:** 0 to 50°C. **TEMPERATURE COEFFICIENT OF VOLTAGE:** $\pm(0.1\% + 1 \text{ mV})/^\circ\text{C}$, typical.

Supplied: Power cord, two locking GR874® coaxial connectors, two 2994-1007 one-foot coaxial cables.

Mechanical: Rack model only. **DIMENSIONS (wxhxd):** 19x3.5x6.38 in. (483x89x162 mm). **WEIGHT:** 10.3 lb (4.7 kg) net, 13 lb (6 kg) shipping.

Description	Catalog Number
Bias Supply	2995-9158

More Versatility for GR Systems



Impedance Measurements

Automatic bridges, described in the preceding pages, are the primary part of many GR systems providing the capability to measure R, L, C, and loss up to 1 MHz.



Frequency Measurement

The Type 1191-B Counter, described fully toward the back of this catalog, is programmable and generates BCD output data for measurements of frequency to 500 MHz as well as period, time interval, and ratio.



Signal Sources Sine-wave test signals from a fraction of a hertz to 500 MHz are available for test systems from one of GR's nine frequency synthesizers. Variations in programmable resolution (down to 0.01 Hz), in sweep capability, and in signal purity offer a wide choice of performance.

The high performance of many manual instruments can also be realized in systems applications; many GR instruments are equipped for automatic operation.



Programmable Attenuation

The GR 1452 Attenuator adds the oft-needed amplitude control to a synthesizer in a system application. It will attenuate any signal from 10 kHz to 500 MHz by 0 to 80 dB in less than half a millisecond.



Line-Voltage Regulation

can ensure continued proper operation of measurement systems in times of reduced line voltage and rapid fluctuations. GR regulators respond quickly, dissipate little power, and add no interference or distortion.



Recorders

under program control can create permanent records of test results and of system function. GR potentiometric strip-chart recorders are fully programmable and will plot dc information and ac levels up to 500 kHz.

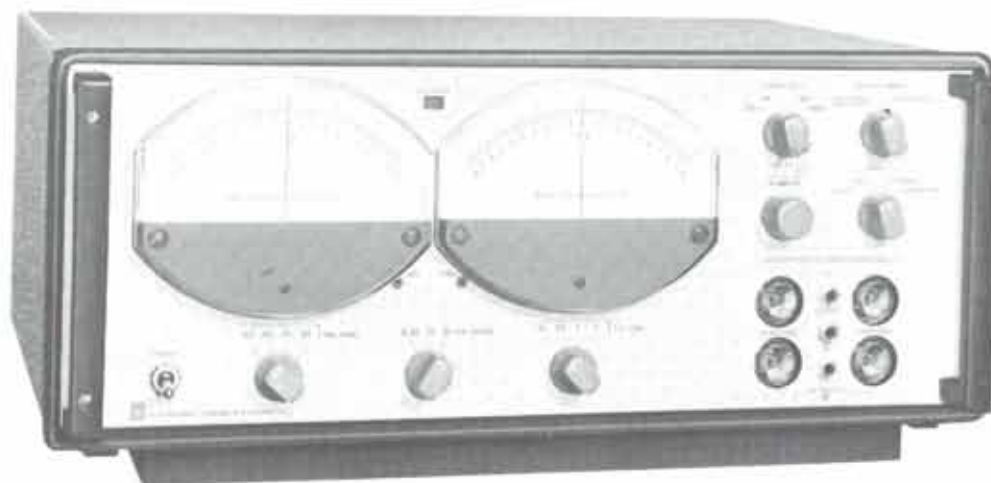

1654 Impedance Comparator

- 0.003% impedance-difference resolution
- 100 Hz to 100 kHz—4 fixed frequencies
- wide impedance ranges:
 - 2 Ω to 20 M Ω
 - 0.1 pF to 1000 μ F
 - 20 μ H to 1000 H
- stable solid-state circuits
- fast sorting —
 - > 10,000/h, with accessory limit comparator

The GR 1654 Impedance Comparator indicates on large panel meters and by analog output voltages the difference in magnitude and phase angle between two external impedances, usually a standard and an unknown. Owing to its speed and percent-deviation readout, the 1654 is of great value in the sorting, selecting, and adjusting of components in production and inspection applications.

Accurate Because the 1654 measures differences to an accuracy of 3% of full scale, the measurement accuracy and resolution as a percent of the total impedance are considerably better, with comparison precisions to $\pm 0.003\%$. In addition, the magnitude channel of the 1654 has been linearized to ensure accurate readings without correction for up to 30% impedance differences. Solid-state circuits are used in the 1654 so that drift of the meter zero is negligible, permitting more certain accuracy and fewer interruptions for readjustment.

Versatile Test voltage, frequency, and measurement ranges of impedance and phase-angle differences are all selected by front-panel controls. Test voltage and measurement ranges are related and their panel switches interlocked to reflect this relationship. Four measurement ranges can be used with each test voltage. The highest test level, 3 volts, gives the greatest sensitivity: 0.1% and 0.001 radian, full scale. The lower levels, 1.0 and

0.3 volt, permit measurement of more fragile components, allow easy voltage-coefficient tests, and (while limiting maximum sensitivity) extend large-difference capability to 30% and 0.3 radian, full scale.

Wide ranges of impedance, resistance, capacitance, and inductance can be compared with the 1654. Since it is a transformer bridge, its accuracy is little affected by loading or by stray impedances for most measurements. A guard terminal is provided for making three-terminal connections to minimize the effects of stray fixture and cable capacitance.



1680-P1 Test Fixture.

HIGH-SPEED SORTING, SYSTEMS EXPANSION

The 1654 measures the difference between two externally connected components. For comparison measurements you need a standard. For rapid sorting you need either a limit comparator or an alert operator who can mentally juggle up to six numbers simultaneously. You can solve these problems neatly by adding to the basic impedance comparator or, more neatly yet, by letting us do the adding in the form of one of several models of the 1654-Z Sorting System.

One model of the 1654-Z contains, in addition to the 1654 Impedance Comparator, one of our latest and best decade capacitors. A second model contains a versatile limit comparator especially designed for the 1654, and a third model contains both.

The 1413 Precision Decade Capacitor provides a range of from 0 to 1.11111 μF , an accuracy of 0.05%, and a resolution of 1 pF. Any value in its range is set easily by six in-line readout dials, and it may be connected to either the front or the rear of the 1654.

The 1782 Analog Limit Comparator provides four limits that you may use as your needs dictate: a high and low limit for both magnitude and phase, two values of magnitude only or phase only, or four high limits to sort components into five categories (say 5, 10, 20 and 30% and reject). All limits can be set to an accuracy of within $\pm 2\%$ of full scale and bright-light panel indicators provide results of the comparison in terms of GO or NO GO. The 1782 is available also with a relay option to control automatic sorting mechanisms. The components can be applied manually or automatically at rates up to four per second. For special applications, up to 16 limit comparators can be connected to the 1654. Call your local GR sales engineer for further details on incorporating additional limit comparators or other automatic measuring and sorting equipment.

TYPICAL USES

Rapid sorting and matching of precision components, subassemblies, and networks, manually or with automatic equipment.

Measuring the effects of time and environment on components, with high precision and continuous indication.

Rapid testing of the tracking of ganged potentiometers and variable capacitors.

Studying the frequency dependence of components.

Easy comparison of quantities usually requiring laboratory techniques, such as:

Small impedance differences.

D of low-loss dielectric materials.

$D \left(= \frac{1}{Q} \right)$ of inductors.

Q or phase angle of wire-wound resistors or potentiometers.

Balance of transformer windings.

Semiconductor capacitances.

Capacitance drift with temperature.

— See GR Experimenter for May-June 1969.

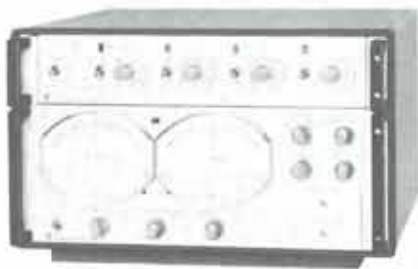

1654-Z1 Sorting System includes limit comparator for additional limits.

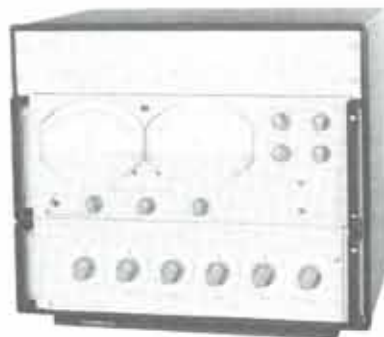

1654-Z2 Sorting System contains precise capacitance decade standard.



1654-Z3 Sorting System includes both a limit comparator and capacitance decade standard.

SPECIFICATIONS

Frequencies: Internal only 100 Hz, 1, 10, and 100 kHz, $\pm 1\%$.

Ranges: 0.1% to 30% full-scale impedance difference; 0.001 to 0.3 radian full-scale phase-angle difference. Available ranges depend on test voltage selected as shown in the following table.

Test Voltage	Impedance Difference						Phase-Angle Difference					
	Full-scale Range — %						Full-scale Range — Radian					
	0.1	0.3	1	3	10	30	0.001	0.003	0.01	0.03	0.1	0.3
0.3 V			x	x	x	x			x	x	x	x
1 V		x	x	x	x			x	x	x	x	
3 V	x	x	x	x			x	x	x	x		

Impedance Ranges (0.3-V test voltage*)

Freq	Resistance	Capacitance	Inductance
100 Hz	2 Ω — 20 M Ω	1000 pF — 1000 μF	5 mH — 1000 H
1 kHz	2 Ω — 2 M Ω	50 pF** — 100 μF	500 μH — 100 H
10 kHz	2 Ω — 200 k Ω	50 pF** — 10 μF	50 μH — 1 H
100 kHz	10 Ω — 10 k Ω	50 pF** — 0.1 μF	20 μH — 10 mH

* Low R and L limits are increased and upper C limit decreased by 10:1 for 1-V test voltage and by 100:1 for 3-V.

** To 0.1 pF by substitution method.

Resolution: Meter, 0.003% and 0.00003 radian. Analog-voltage output, 0.001% and 0.00001 radian.

Accuracy: 3% of full scale.

Voltage Across Standard and Unknown: 0.3, 1, or 3 V selected by front-panel control. Test voltage of 2 V (with 0.6 and 6 V) can be obtained on special order.

Analog-Voltage Outputs: Voltages proportional to meter deflections at two rear-panel connectors: ± 10 V full scale behind $< 10 \Omega$ for 1782 Analog Limit Comparator; ± 3 V or ± 10 V (depending on range) full scale behind 2 k Ω for DVM, A-D converter or other use.

Test Speed: About 1 component per second with meter, max. With analog output voltage, about 4 components per second, except about 1 component per second at 100 Hz.

Power: 105 to 125 or 210 to 250 V, 50-60 Hz, 15 W except 1654-Z1, 35 W.

Supplied: Multiple-contact connector and power cord.

Available: 1782 ANALOG LIMIT COMPARATOR (supplied with -Z1 and -Z3); 1413 PRECISION DECADE CAPACITOR (supplied with -Z2 and -Z3) and other GR decade boxes and standards of resistance, capacitance, and inductance; 1680-P1 TEST FIXTURE for rapid connection of components (includes con-

necting cables); 1654-9600 ADAPTOR KIT for components with $\frac{3}{4}$ -in. spaced leads; 874-MB COUPLING PROBES for components with $1\frac{1}{4}$ -in. spaced leads; and 874-R33 PATCH CORDS for connection to GR874®-terminated standards or unknowns.

Mechanical: 1654, bench or rack models; 1654-Z, all units mounted in a single cabinet with necessary interconnections made. DIMENSIONS (wxhxd): 1654 bench, 19.5x8.75x15 in. (495x222x381 mm); 1654 rack, 19x7x13.5 in. (483x178x343 mm); 1654-Z1, 12x19.5x15 in. (305x222x381 mm); 1654-Z2, -Z3, 17.5x19.5x15 in. (445x222x381 mm). WEIGHT: 1654 bench, 40 lb (19 kg) net, 60 lb (28 kg) shipping; 1654 rack, 25 lb (12 kg) net, 40 lb (19 kg) shipping; 1654-Z1, 51 lb (24 kg) net, 63 lb (29 kg) shipping; 1654-Z2, 66 lb (30 kg) net, 79 lb (36 kg) shipping; 1654-Z3, 77 lb (35 kg) net, 90 lb (42 kg) shipping.

Description	Catalog Number
1654 Impedance Comparator	
Bench Model	1654-9700
Rack Model	1654-9701
1654-Z Sorting Systems (bench only)	
1654-Z2 includes 1413 Decade Capacitor	
1654-Z1 includes 1782 Limit Comparator	(Describe exactly as shown at left.)
1654-Z3 includes 1413 and 1782	
Select, if desired, with -Z1 and -Z3 only	
OP6 Relay Output	
Accessories Available	
1680-P1 Test Fixture	1680-9601
1654-9600 Adaptor Kit	1654-9600
874-MB Coupling Probe (2 req'd for each term pair)	0874-9666
874-R33 Patch Cord (2 req'd for each term pair)	0874-9690



1782 Analog Limit Comparator

- accessory to 1654 Impedance Comparator
- 4 independent limits — use for high or low
- 2% of full scale accuracy
- GO/NO GO lights, optional contact closures

The GR 1782 Analog Limit Comparator increases the speed at which the 1654 Impedance Comparator will operate in sorting applications. It compares the analog-voltage output of the 1654 against high and low limits set on the 1782 front panel and displays GO or NO GO lights for manual sorting. Optional relay-equipped models will operate external automatic-sorting devices. Up to 4 com-

ponents per second can be measured with the two instruments together.

Four controls on the front panel permit the limits to be set to 1% resolution; each control can act as either a high limit or a low limit as selected on an adjoining switch and for ΔZ or $\Delta \theta$ as selected by a rear-panel switch.

— See *GR Experimenter* for May-June 1969.

SPECIFICATIONS

Input: ANALOG VOLTAGE: ± 10 V full scale. RESISTANCE (of each comparator): 66 k Ω , approx.

Output: ANALOG VOLTAGE: identical to input. DECISION OUTPUTS: Visual or relay contacts. *Visual:* NO-GO lamp for each limit; GO lamp indicates measurement is within all limits. *Relay Contacts* (optional): 5 SPDT contacts, 115 V rms, 0.1 A rms, max.

Accuracy: $\pm 2\%$ of full scale.

Limit Controls: Four independent limits; can be set for + (high) or - (low) with switch adjoining each control. DUAL CONTROLS: Inner scale calibrated 0 to 100 (each division corresponds to 100 mV), outer scale calibrated 0 to 30 (316 mV per division).

Test Speed: Approx 10 tests per second, max, for visual output.

Power: 105 to 125 or 210 to 250 V, 50 to 60 Hz, 20 W.

Supplied: 24-contact connector with relay models only, input-signal cable, power cord.

Mechanical: Convertible bench cabinet. DIMENSIONS (wx hxd): Bench, 17x3.88x9.88 in. (432x99x251 mm); rack, 19x 3.5x8.63 in. (483x89x220 mm). WEIGHT: 9 lb (4 kg) net, 15 lb (7 kg) shipping.

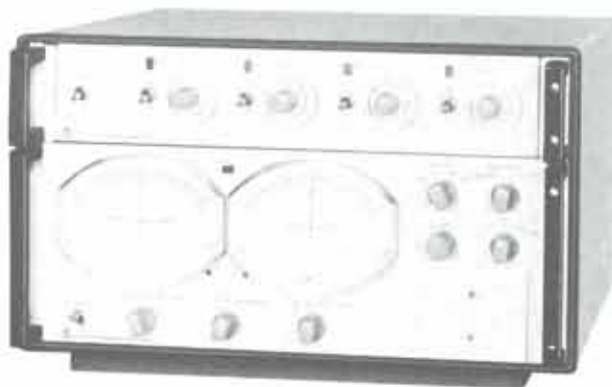

The 1782 is shown here with the 1654 Impedance Comparator to form one version of the 1654-Z Sorting System.

Description	Catalog Number
1782 Analog Limit Comparator	
Bench Model, without relays	1782-9700
Rack Model, without relays	1782-9701
Bench Model, with relays	1782-9702
Rack Model, with relays	1782-9703



1656 Impedance Bridge

- measures R, L, C, and G
- 0.1% basic accuracy
- fast lever balancing
- digital readout of RLC and G
- portable, self-contained

Today's components demand high-precision measurements; today's schedules demand fast answers. GR's 1656 meets these demands. A precision adaptation of a long-time favorite bridge, the 1656 simplifies 4-place balancing with lever switches and reduces possible reading error with in-line digital readout of impedance.

Though of laboratory accuracy, the 1656 is also the ideal general-purpose instrument for production, inspection, and field use. It's fully portable and self-contained for both ac and dc measurements and demands no special training for proper use.

Measure extremely large or small value of R or G with ease — you will appreciate the extraordinary sensitivity of the detector in this instrument. Indeed, there are few

impedance measurements that will challenge it, whether dc or audio-frequency. Notice the width of the ranges specified below.

— Note: This product is manufactured also in Europe.
— See **GR Experimenter** for March/June 1970.

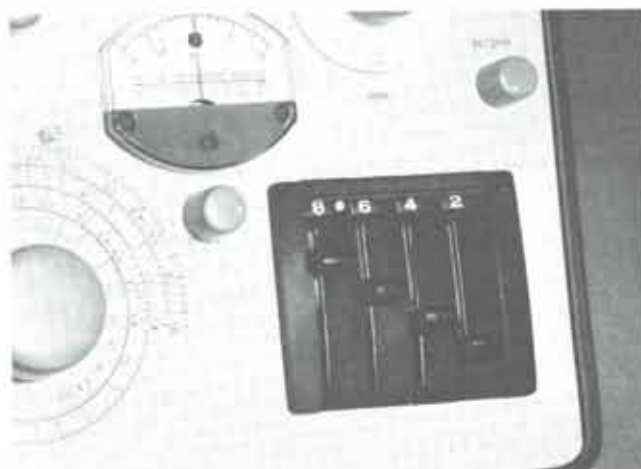

Lever-arm switches on 1656 permit fast balances and easy-to-read answers.

SPECIFICATIONS

Range	Resolution (one digit on lowest range)	Accuracy*	
		Frequencies ≤ 1 kHz and small phase angle ($f_s =$ full scale)	Frequencies > 1 kHz or large phase angle Typical additional error terms
Capacitance: 0.1 pF to 1100 μ F Series or parallel, 7 ranges	0.1 pF	$\pm(0.1\%$ of reading $+ 0.01\%$ of $f_s +$ 0.2% of reading on highest range)	$\pm(0.2 D f_{w_0} + 0.5 D^2 + 0.002 (f_{w_0})^2)\%$
Inductance: 0.1 μ H to 1100 H Series or parallel, 7 ranges	0.1 μ H	$\pm(0.1\%$ of reading $+ 0.01\%$ of $f_s +$ 0.2% of reading on lowest range)	$\pm(0.2 f_{w_0}/Q + 0.5/Q^2 + 0.002 (f_{w_0})^2)\%$
Resistance: 0.1 m Ω to 1.1 M Ω Ac or dc, 7 ranges	0.1 m Ω	$\pm(0.1\%$ of reading $+ 0.01\%$ of $f_s +$ 0.2% of reading on lowest range)**	$\pm(Q f_{w_0} + 0.003 (f_{w_0})^2)\%^{**}$
Conductance: 0.1 n Ω to 1.1 Ω Ac or dc, 7 ranges	0.1 n Ω	$\pm(0.1\%$ of reading $+ 0.01\%$ of $f_s +$ 0.2% of reading on highest range)**	$\pm(Q f_{w_0} + 0.003 (f_{w_0})^2)\%^{**}$
Dissipation Factor, D: series capacitance	0 to 1	—	$\pm(0.001 f_{w_0} + 5\%$ of reading)
parallel capacitance	0.1 to 50	—	$\pm 5\%$ of reading (sliding null at high D)
Storage Factor, Q: series inductance	0.02 to 10	—	$\pm 5\%$ of reading (sliding null at low Q)
parallel inductance	1 to ∞	—	$\pm(5\%$ of reading $+ 0.001$) for $1/Q$ $\pm(5\%$ of reading $+ 0.001 f_{w_0}$) for $1/Q$

* Full accuracy applies from 15 to 35°C, <85% RH (useful from 0 to 45°C). Residual terminal impedances of ≈ 0.3 pF, 0.15 μ H, and 1 m Ω must be corrected to obtain specified accuracy.

** Terms apply to ac measurements when external phase balance is properly adjusted; otherwise accuracy is 0.5% of reading.

Generator: Internal, 1 kHz $\pm 2\%$ ac, 1.5 V dc. External, 20 Hz to 20 kHz ac; Type 1310 or 1311 Oscillator recommended.

Detector: Internal, 1 kHz ac with >20 -dB rejection at 2nd harmonic or flat, meter indication; 10- μ V/mm dc meter sensitivity. External, Type 1232 Tuned Amplifier and Null Detector recommended.

Bias: 600 V max on capacitors; small currents allowable on inductors and resistors; external only.

Terminals: $\frac{3}{4}$ -in.-spaced binding posts for unknown; pin jacks for external ac generator and capacitor for ac phase balance; phone jacks for external detector, bias, and DQ adjustment.

Supplied: Batteries.

Available: 1650-P1 TEST JIG for rapid and convenient connection of axial-lead components to bridge. Permits 3-terminal connection for negligible zero capacitance, introduces 80-m Ω total lead resistance (which only affects measurements on very low impedances), and adds a D or 1/Q error of less than 0.007.

Power: 5 D-cells, supplied; battery checks provided.

Mechanical: Flip-Tilt case and rack mount. DIMENSIONS (wxhxd): Portable, 13.25x12.87x6.69 in. (337x327x170 mm); rack, 19x12.25x5.75 in. (483x311x146 mm). WEIGHT: Portable, 15 lb (7 kg) net, 21 lb (10 kg) shipping; rack, 16 lb (8 kg) net, 28 lb (13 kg) shipping.



Flip-Tilt case provides complete protection.

Description	Catalog Number
1656 Impedance Bridge	
Portable Model	1656-9701
Rack Model	1656-9702
D Cell , replacement battery for 1656 (5 req'd)	8410-0200



1650-P1 Test Jig

This test-jig adaptor is used to connect components quickly to a pair of terminals and can be placed on the bench directly in front of the operator. Thus, the test jig and 1650-B, 1656, or 1608-A Impedance Bridge make a

rapid and efficient component sorting device when the panel meter of the bridge is used as a limit indicator.

The test jig makes a three-terminal connection to the bridge, so that the residual zero capacitance is negligible. The lead resistance (0.08 ohm total) has effect only when very low impedances are measured, and the lead capacitance affects only the measurement of the Q of inductors, introducing a small error in D (or $\frac{1}{Q}$) of less than 0.007.

Weight: Net, 10 oz (285 grams); shipping, 4 lb (1.9 kg).

Description	Catalog Number
1650-P1 Test Jig	1650-9601



1608-A Impedance Bridge

- measures C, R, L, and G with digital readout
- $\pm 0.05\%$ accuracy
- 20 Hz to 20 kHz (external generator)
- internal 1-kHz oscillator and detector
- measures impedance of any phase angle
- accurate D and Q readings

This wide-range bridge will measure precision components to an accuracy of 0.05% — capacitance, inductance, and ac as well as dc resistance and conductance. An almost error-free readout and rapid-balance adjustments allow accurate and fast laboratory or production tests. Six bridge circuits cover all possible phase angles so that any network can be measured, even such "black boxes" as filters, transducers, and equalizers.

In ac resistance and conductance measurements, a Q adjustment for precise balancing gives phase information useful in predicting high-frequency behavior. This capability is also useful for measuring lossy reactances, such as rf chokes, without a sliding null. The high phase precision of ± 0.0005 radian makes D or Q measurements meaningful on low-loss reactances, which must often have tight D or Q tolerances for use in precision networks.

The 1608-A will measure resistors at EIA-specified dc voltages, three-terminal capacitors and small capacitors remotely located, voltage-biased capacitors or current-biased inductors and resistors. Almost any impedance is measurable over the audio-frequency range.

The ability to measure small capacitances by a three-terminal connection makes possible the measurement of the capacitance between components, wires, or mounting structures. Long, shielded cables can be used without significantly affecting the accuracy of the measurement.

For production testing of components, the 1650-P1 test jig is recommended.

This self-contained bridge system includes six bridges, along with suitable ac and dc sources and detectors. The bridge elements are precision units. The wire-wound resistors are similar to those used in GR decade resistance boxes; the standard capacitor is a combination silver-mica and stabilized-polystyrene unit, with a low temperature coefficient.

The readout system is digital for C, R, L, and G, as well as for the Q of resistors. D and Q for capacitors and inductors are read from a dial with the correct scale illuminated. Decimal points and units are indicated automatically, and there are no multiplying factors for any quantity at 1 kHz or dc.

The C-R-L-G readout has both coarse and fine adjustments controlled by concentric knobs.

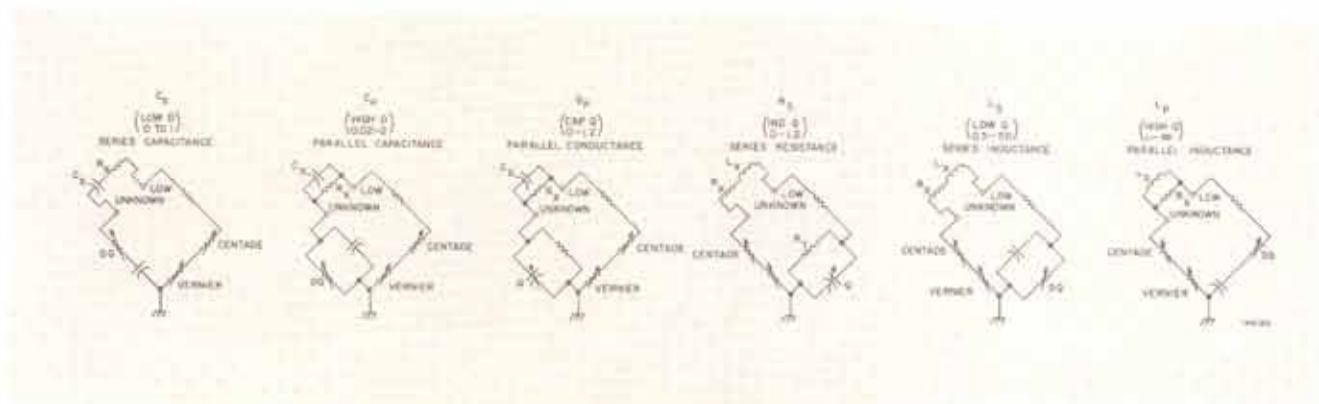

Elementary schematics of the capacitance, conductance, resistance, and reactance bridges.

The 1-kHz frequency-selective networks for the internal oscillator and tuned detector are on a plug-in module, which can be easily replaced with modules available for other internal test frequencies. Provision is made for use with an external oscillator and detector. Three dc supplies are included to obtain maximum sensitivity over a wide range of resistance.

SPECIFICATIONS

Ranges:

Capacitance: 0.05 pF to 1100 μ F in seven ranges, series or parallel.

Inductance: 0.05 μ H to 1100 H in seven ranges, series or parallel.

Resistance: (series) 0.05 milliohm to 1.1 megohms, ac or dc.

Conductance: (parallel) 0.05 nanomho to 1.1 mhos, ac or dc (20,000 megohms to 0.9 ohm).

D: (of series capacitance) — 0.0005 to 1 at 1 kHz.
(of parallel capacitance) — 0.02 to 2 at 1 kHz.

Q: (of series inductance) — 0.5 to 50 at 1 kHz.
(of parallel inductance) — 1 to 2000 at 1 kHz.
(of series resistance) — 0.0005 to 1.2 inductive at 1 kHz.
(of parallel conductance) — 0.0005 to 1.2 capacitive at 1 kHz.

Frequency: 1 kHz with internal oscillator module supplied; 20 Hz to 20 kHz with external oscillator.

Accuracy:

C, G, R, L

At 1 kHz: $\pm 0.05\% \pm 0.005\%$ of full scale except on lowest R and L ranges and highest C and G ranges, where it is $\pm 0.2\% \pm 0.005\%$ of full scale.

Additional error terms for high frequency and large phase angle:

C and L: $[\pm 0.001(f_{MHz})^2 \pm 0.1Df_{MHz} \pm 0.5D^2]\%$ of measured value.

R and G: $[\pm 0.002(f_{MHz})^2 \pm 10^{-4}(f_{MHz})^2 \pm 0.1Q]\%$ of measured value.

Residual Terminal Impedance: R \approx 0.001 Ω , L \approx 0.15 μ H, C \approx 0.25 pF.

DC Resistance and Conductance: Same as for 1-kHz measurement, except that accuracy is limited by sensitivity at the range extremes. Balances to 0.1% are possible from 1 ohm to 1 megohm with the internal supply and detector.

D (or $\frac{1}{Q}$) of C or L: $\pm 0.0005 \pm 5\%$ at 1 kHz or lower.
 $\pm 0.0005f_{MHz} \pm 5\%$ above 1 kHz.

Q of R or G: $\pm 0.0005f_{MHz} \pm 2\%$.

Generator: Internal, 1 kHz $\pm 1\%$ module normally supplied; plug-in modules for other frequencies available on special order. Level control provided. With external generator, frequency range of bridge is 20 Hz to 20 kHz. Type 1310-B Oscillator recommended if external generator required. Internal dc supply 3.5, 35, and 350 V, adjustable; power limited to $\frac{1}{2}$ W or less.

Detector: Internal or external; ac; can be used either flat or selective at frequency of plug-in module (normally 1 kHz); other frequencies available; second-harmonic rejection of 25 dB. Sensitivity control provided. Type 1232-A Tuned Amplifier and Null Detector recommended when external generator is used.

Dc Bias: Capacitors can be biased to 500 V from external source; bias current up to 40 mA can be applied to inductors.

Supplied: Power cord, spare indicator lamps.

Available: 1650-P1 TEST JIG.

Power: 105 to 125 or 210 to 250 V, 50 to 60 Hz; 10 W.

Mechanical: Rack-bench cabinet. DIMENSIONS (wxhxd): Bench, 19x12.5x11.5 in. (483x318x293 mm); rack, 19x12.25x10 in. (483x312x254 mm). WEIGHT: 37 lb (17 kg) net, 54 lb (25 kg) shipping.

Description	Catalog Number
1608-A Impedance Bridge	
Bench Model, 115 V	1608-9801
Bench Model, 230 V	1608-9802
Rack Model, 115 V \leftrightarrow	1608-9811
Rack Model, 230 V	1608-9812

\leftrightarrow Federal stock numbers are listed before the Index.

1650-B Impedance Bridge

- measures L, C, and loss; R and G
- 1% accuracy
- 20 Hz to 20 kHz, internal 1 kHz and dc
- portable, self-contained, battery-operated



The 1650 Impedance Bridge will measure the inductance and storage factor, Q , of inductors*, the capacitance and dissipation factor, D , of capacitors, and the ac and dc resistance or conductance of resistors.

Three-terminal measurements can be made in the presence of considerable stray capacitance to ground.

This bridge is completely self-contained and portable. Battery-powered, low-drain solid-state oscillator and detector are included. The panel meter indicates both dc and ac bridge unbalances.

The measured quantities, R , G , L , C , D , and Q , are indicated directly on dials with logarithmic scales for constant percentage accuracy. Multipliers and the units of measurement are indicated by the range setting.

The bridge circuit elements are high-quality, stable components that ensure long-term accuracy. The Ortho-null® balance finder, a patented mechanical-ganging device, is used to make a low- Q (high- D) balance possible without a sliding null. This mechanism, which may be switched in or out as desired, adds accuracy as well as

convenience to low- Q measurements that are practically impossible on other impedance bridges.

The Flip-Tilt case provides a convenient handle and a captive protective cover and base that allow the bridge panel to be tilted for use at any angle.

— Note: This product is manufactured also in Europe.
— See **GR Experimenter** for March/June 1970.

* Including such low- Q inductors as rf coils measured at 1 kHz.

SPECIFICATIONS

Ranges of Measurement	Accuracy		
	20 Hz to 20 kHz †	DC	Residuals
Capacitance 1 pF to 1100 μ F, series or parallel, 7 ranges	$\pm 1\% \pm 1$ pF	—	≈ 0.5 pF
Inductance 1 μ H to 1100 H, series or parallel, 7 ranges	$\pm 1\% \pm 1$ μ H	—	≈ 0.2 μ H
Resistance ac or dc, 1 m Ω to 1.1 M Ω , 7 ranges	$\pm 1\% \pm 1$ m Ω	$\pm 1\%$, 1 Ω to 100 k Ω , ext supply or detector required for > 100 k Ω and < 1 Ω .	≈ 1 m Ω
Conductance ac or dc, 1 n Ω to 1.1 U, 7 ranges	$\pm 1\% \pm 1$ n Ω	$\pm 1\%$, 10 μ U to 1 U, ext supply or detector required for < 10 μ U.	
Dissipation Factor, D, at 1 kHz: 0.001 to 1, of series C, 0.1 to 50, of parallel C.	$\pm 5\% \pm 0.001$ at 1 kHz and lower	—	
Storage Factor, Q, at 1 kHz: 0.02 to 10, of series L, 1 to 1000, of parallel L.	1/ Q accurate to $\pm 5\% \pm 0.001$ at f ≤ 1 kHz	—	

† Bridge operates up to 100 kHz with reduced accuracy.

Generator: Internal; 1 kHz $\pm 2\%$. Type 1310 or 1311 Oscillator recommended if external generator is required. Internal dc supply, 6 V, 60 mA, max.

Detector: Internal or external; internal detector response flat or selective at 1 kHz; sensitivity control provided. Type 1232-A Tuned Amplifier and Null Detector is recommended if external detector is required. Combination of 1311 oscillator and 1232 detector is available as the 1240 Bridge Oscillator-Detector.

DC Polarization: Capacitors can be biased to 600 V from external dc power supply for series capacitance measurements.

Required: None. Earphones can be used for high precision at extremes of bridge ranges.

Available: Type 1650-P1 TEST JIG.

Power: 4 size-D cells, supplied.

Mechanical: Flip-Tilt case and rack mount. **DIMENSIONS** (wxhxd): Portable, 13x6.75x12.25 in. (330x171x311 mm); rack, 19x12.25x4.13 in. (483x311x105 mm). **WEIGHT:** Portable, 17 lb (8 kg) net, 21 lb (10 kg) shipping; rack, 18 lb (9 kg) net, 30 lb (14 kg) shipping.

Description	Catalog Number
1650-B Impedance Bridge	
Portable Model ☉	1650-9702
Rack Model	1650-9703
Replacement Battery , size D cell, 4 req'd	8410-0200
Patent Number 2,966,257.	

☉ Federal stock numbers are listed before the Index.

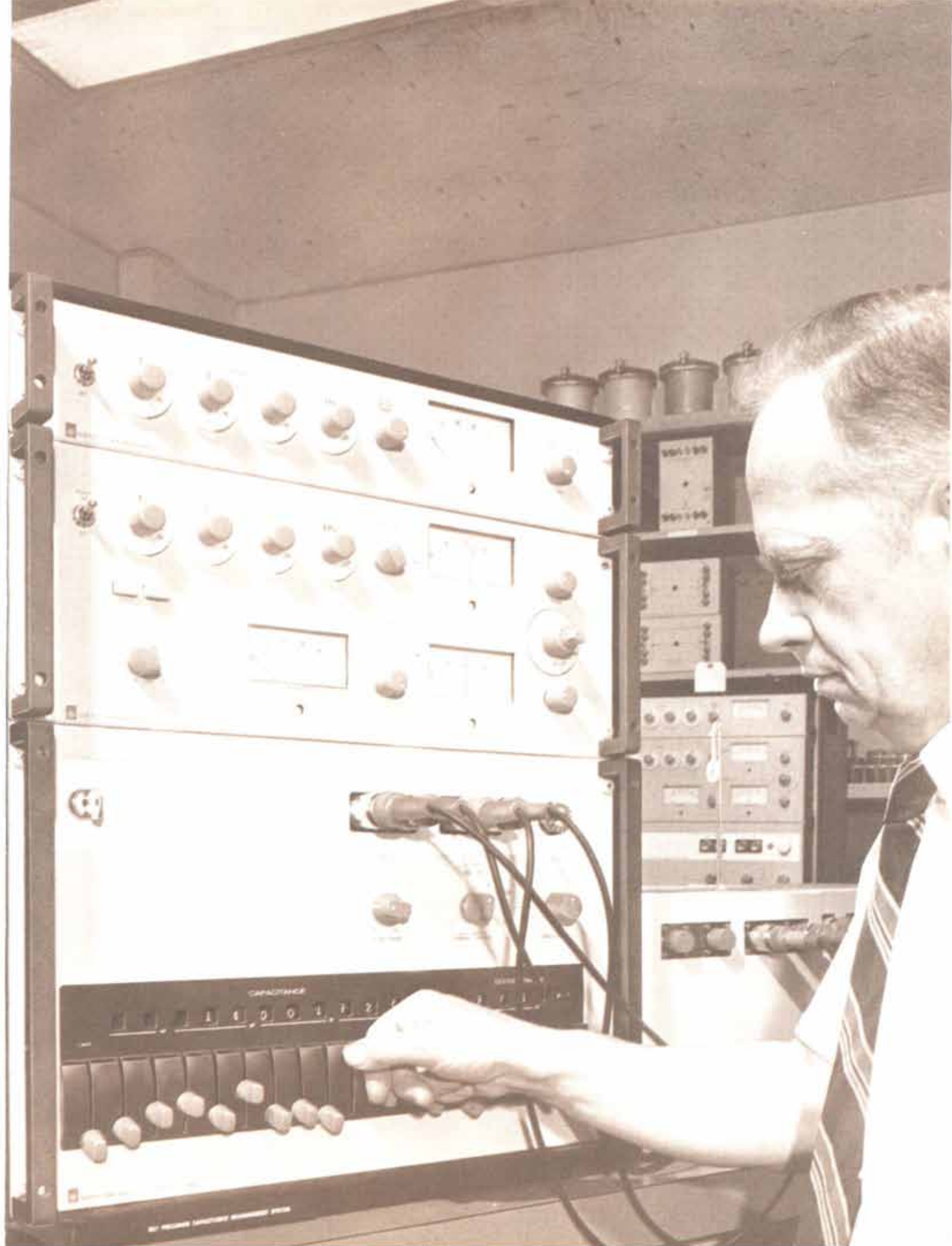

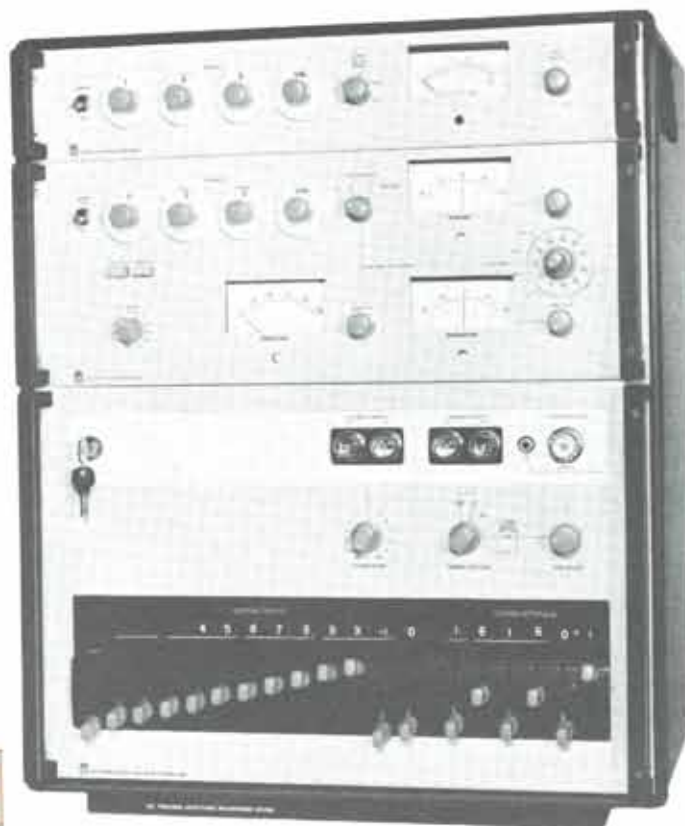

New Since
Catalog U

1621 Precision Capacitance - Measurement System

- 10^{-7} pF to $10 \mu\text{F}$
12-digit readout, 10-ppm basic accuracy
- $10^{-10} \mu\text{S}$ to $1000 \mu\text{S}$
5-digit readout, 0.1% basic accuracy
- 10 Hz to 100 kHz
- 3-terminal measurements
with 2- or 3-terminal connection
- comparison measurements
- simple lever balance with in-line readout

The whole of precision The 1621 represents the first major improvement in nearly a decade in ultra-precise laboratory capacitance intercomparisons and dielectric measurements. It is a completely self-contained system capable of capacitance measurements in increments as small as 0.1 aF (10^{-7} pF) and conductance measurements in increments as small as 100 aS ($10^{-10} \mu\text{S}$; equivalent to a shunt resistance of $10^{10} \text{ M}\Omega$). Measurements are three terminal, with 2- or 3-terminal connection, and provision is also made for the connection of an external standard for comparison measurements.

Such capability and precision are usually accompanied by restricted frequency and complex operation. The 1621, however, avoids these difficulties. Little degradation of performance occurs from 10 Hz to 10 kHz and operation to 100 kHz is possible. Balances are achieved by in-line readout lever switches — easily adjusted and read correctly. All digits of capacitance and conductance, as well as pertinent multipliers, are also provided by BCD-coded contact closures, available at rear-panel connectors for use by printers or data-processing equipment.

Three integrated units The 1621 is an assembly of three integrated instruments: A precision ratio-arm bridge, a highly stable oscillator, and an extremely sensitive detector. Most of the bridge's internal standards are enclosed in an insulated housing to reduce the effects of ambient temperature changes; unused standards are disconnected to reduce shunt capacitance at the detector input. The oscillator provides up to 125 V or 5 A for sufficient signal to be detected even with unbalances as small as one part in 10^4 of 10 pF . The detector contains three meters to help you speed the balance: One displays the magnitude and the other two simultaneously display the in-phase and quadrature components of any unbalance.

— See *GR Experimenter* for October/December 1970.

SPECIFICATIONS

(See 1616 for performance specifications)

Frequency: 10 Hz to 100 kHz.

Supplied: 1616 Precision Capacitance Bridge, 1316 Oscillator, 1238 Detector, all necessary interconnection cables, and power cord.

Available: 1408 REFERENCE STANDARD CAPACITORS (10 pF and 100 pF) for calibration.

Power: 100 to 125 and 200 to 250 V, 50 to 60 Hz, 51 W.

Mechanical: Bench or rack models. DIMENSIONS (wxhxd): Bench, 19.75x24.25x15 in. (502x616x381 mm); rack, 19x20.91x11.44 in. (483x531x291 mm). WEIGHT: Bench, 105 lb (48 kg) net, 140 lb (64 kg) shipping; rack, 90 lb (41 kg) net, 125 lb (57 kg) shipping.

Description	Catalog Number
1621 Precision Capacitance-Measurement System	
Bench Model, 60-Hz	1621-9701
Rack Model, 60-Hz	1621-9702
Bench Model, 50-Hz	1621-9703
Rack Model, 50-Hz	1621-9704

New Since
Catalog U

1616 Precision Capacitance Bridge

- 10^{-7} pF to $10 \mu\text{F}$ — 12-digit readout
- $10^{-10} \mu\text{S}$ to $1000 \mu\text{S}$ — 5-digit readout
- 10 Hz to 100 kHz
- up to 150-V input from oscillator
- 3-terminal measurements
- coaxial measurements

The heart of precision The 1616 is the heart of the 1621 Capacitance-Measuring Assembly. The bridge is also available separately for use where oscillator and detector are on hand or in applications in which they must be specialized for a unique need.

The 1616 employs a transformer ratio-arm bridge with which unbalances as small as 0.1 aF (10^{-13} pF) and 100 aS ($10^{-10} \mu\text{S}$) can be resolved. Detection of such small unbalances is aided by ratio-transformer voltage capabilities up to 160 volts at 1 kHz and by range switching that disconnects the unused internal standards in order to reduce shunt capacitance across the detector input.

SPECIFICATIONS

Capacitance measurement, 3-terminal: DECADES: 12. RANGE: 0.1 aF to $1 \mu\text{F}$ (10^{-13} to 10^{-1} F). ACCURACY: ± 10 ppm, when most-significant decade is 1, 10, or 100 pF per step; otherwise, and at other frequencies, accuracy is $\pm [50 \text{ ppm} + (0.5 + 20 C_{\mu\text{F}}) (f_{\text{kHz}})^2 \text{ ppm} + (f_{\text{kHz}}) \text{ aF}]$.

Capacitance, 2-terminal: Same as above, except as follows. RANGE: One additional decade, to $10 \mu\text{F}$ (10^{-11} to 10^{-1} F).

Conductance measurement, 3-terminal: DECADES: 5 (virtually extended to 11 by G multiplier). RANGE: 100 aS to $100 \mu\text{S}$ (10^{-11} to 10^{-1} S). ACCURACY: $\pm (0.1\% + 1 \text{ step in least significant decade})$. There is a small reduction in conductance accuracy at frequencies other than 1 kHz. RESIDUAL C (across conductance standards): $\pm (< 0.03 \text{ pF})$.

Conductance, 2-terminal: Same as above, except as follows. RANGE: One additional decade, to $1000 \mu\text{S}$ (10^{-10} to 10^{-1} S).

Multipliers: FOR 3-TERM: X1, X10; FOR 2-TERM: X1, X10, X100; affect both C and G. FOR CONDUCTANCE ONLY: X1, X10⁻¹, . . . X10⁻⁶ (7 positions). Effects of these multipliers are included in the specified ranges.

Frequency: 10 Hz to 100 kHz.

Standards: CAPACITANCE: Air dielectric with TC $< +20$ ppm/ $^{\circ}\text{C}$ and D < 10 ppm for 8 lowest decades; Invar[†], air dielectric with TC of $+3 \pm 1$ ppm/ $^{\circ}\text{C}$ and D < 10 ppm for 3 middle decades; mica dielectric with TC of 20 ± 10 ppm/ $^{\circ}\text{C}$ and D < 200 ppm for 2 highest decades. ADJUSTMENTS for all capacitance standards available through key-locked door on panel. THERMAL LAG: C standards for first 8 decades mounted in an insulated compartment with a thermal time constant of 6 h (time required for compartment interior to reach 63% of ambient change). CONDUCTANCE: Metal-film resistors in T networks with small phase angles.

^{*}Accuracy stated as fraction of measured value, for these conditions: frequency, 1 kHz, except as noted; temperature, $23^{\circ} \pm 1^{\circ}\text{C}$; humidity, $< 50\% \text{ RH}$.

[†]Registered trademark of the Carpenter Steel Co.



For thermal stability in precision intercomparisons, eight of the twelve internal capacitance standards are mounted in an insulated compartment to reduce the effects of ambient temperature changes. Misreading the values at balance is virtually impossible due to direct-reading lever switches that control the balance for both capacitance and conductance. Panel layout is unusually neat — only the unknown capacitor and, if desired, an external standard for comparison measurements are connected to the front panel; the oscillator and detector are connected to the rear as are the BCD data-output channels.

— See *GR Experimenter* for October/December 1970.

Comparison: Terminals provided to connect external standard for comparison measurements; 13-position panel switch multiplies standard by $-0.1, 0 \dots +1$.

Input: The smaller of 160 f_{rms} or 350 V rms can be applied to the bridge transformer at the GENERATOR terminal without waveform distortion; 500 V rms max, depending on conductance range, when GENERATOR and DETECTOR connections are interchanged.

Interface: GR900[®] locking coaxial connector on panel to connect 2-terminal unknowns, 2 gold-plated GR874[®] locking coaxial connectors on panel to connect 3-terminal unknowns and 2 to connect external standard. DATA OUTPUT: 50-pin and 36-pin type 57 connectors on rear provide connection to 8-4-2-1 weighted BCD contacts (rated at 28 V, 1 A) on each switch for capacitance and conductance values respectively. OSCILLATOR and DETECTOR: Connect to rear BNC connectors.

Required: OSCILLATOR: GR 1316 recommended. DETECTOR: GR 1238 recommended. The 1616 Bridge is available with this oscillator and detector as the 1621 Capacitance-Measuring Assembly.

Available: 1316 OSCILLATOR, 1268 DETECTOR, a broad line of capacitance and resistance standards, and coaxial cables for connection of unknowns and standards.

Mechanical: Bench or rack model. DIMENSIONS (wxhxd): Bench, 19.75x13.81x12.88 in. (502x351x327 mm); rack, 19x12.22x10.56 in. (483x310x268 mm). WEIGHT: Bench, 57 lb (26 kg) net, 69 lb (32 kg) shipping; rack, 49 lb (23 kg) net, 61 lb (28 kg) shipping.

Description	Catalog Number
1616 Precision Capacitance Bridge	
Bench Model	1616-9700
Rack Model	1616-9701

New Since
Catalog U



1316 Oscillator

- 10 Hz to 100 kHz
- up to 125 V or 5-A output
- output level adjustable and metered
- in-phase and quadrature reference outputs
- in-line readout dials
- current-limited output — short circuits OK

Convenience and performance Set four controls and the 1316 provides any frequency from 10 Hz to 100 kHz with 1% accuracy and with little chance of an improper setting — the dials provide in-line readout, including decimal point and frequency units. Set two more controls, and the 1316 provides up to 1.6 watts of output power (125 V open circuit or 5 A short circuit), low distortion, and accurate metering.

These features alone would qualify the 1316 as an excellent general-purpose oscillator but it offers more: Output constant within $\pm 2\%$, excellent stability (only 0.005% drift over a 12-hour period), and a synchronizing feature that allows the oscillator to be locked to an external standard for even greater accuracy and stability.

Excellent bridge oscillator The 1316 is a high-performance bridge oscillator specifically intended for use with the 1238 Detector and the 1616 Precision Capacitance Bridge. The oscillator supplies 2 references (in quadrature) for the 2-phase phase-sensitive detector, which enables you to make independent and ultra-precise balances of the conductance (real part) and capacitance (imaginary part) of capacitive devices.

The 1316 contains a Wien-bridge oscillator isolated from the load by a low-distortion transformer-coupled power amplifier. The oscillator circuit includes a provision to introduce a synchronizing signal for phase locking or to extract a signal, independent of the output setting, to operate a counter or to synchronize an oscilloscope.

— See **GR Experimenter** for October/December 1970.

SPECIFICATIONS

Frequency: 10 Hz to 100 kHz in 4 decade ranges. Controlled by one 11-position and one 10-position switch for the most-significant digits and a continuously adjustable dial with detented zero position for the third digit; in-line readout with decimal point and frequency units.

Accuracy: $\pm 1\%$ of setting with continuously adjustable dial at zero detent position. **DRIFT** (typical at 1 kHz): Warmup 0.1%,

short-term (10 min) 0.001%, long-term (12 h) 0.005%. **RE-SETTABILITY:** Within 0.005%.

Power Output: CONTROLLED by 5-position switch and uncalibrated vernier. MONITORED by meter with $\pm 3\%$ accuracy. AVAILABLE at rear BNC connector.

	Output Range				
	1.5 V	5 V	15 V	50 V	150 V
Open circuit E, rms	≥ 1.25 V	≥ 4 V	≥ 12.5 V	≥ 40 V	≥ 125 V
Distortion	$< 0.2\%$ from 100 Hz to 10 kHz				
Hum	0.003% of max output				
Response	output constant within $\pm 2\%$ from 10 Hz to 100 kHz*				
Short Circuit I	5 A	1.6 A	0.5 A	0.16 A	0.05 A
Distortion	$< 0.2\%$ from 100 Hz to 10 kHz				
Impedance	0.25 Ω	2.5 Ω	25 Ω	250 Ω	2.5 k Ω
Power	1.6 W max into matched load				

* $\pm 5\%$ for outputs > 30 V rms at frequencies > 50 kHz.

Reference Outputs: Quadrature output lags in-phase output by 90° . Each available at rear BNC connectors.

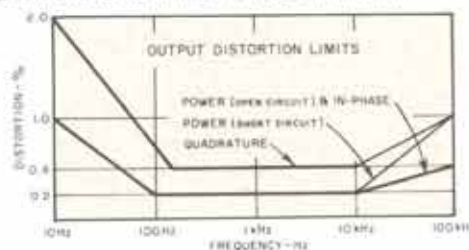

	In-Phase	Quadrature
Output, open-circuit	1.25 \pm 0.25 V rms	
Distortion, 100 Hz to 10 kHz	$< 0.2\%$	$< 0.4\%$
Response, 10 Hz to 10 kHz	$\pm 2\%$	
10 kHz to 100 kHz	$\pm 4\%$	
Minimum Load	47 k Ω	

Synchronization: INPUT: Frequency can be locked to external signal; lock range, $\pm 1\%$ /V rms input up to 10 V; frequency controls function as phase adjustment. OUTPUT: ≥ 0.3 V rms behind 27 k Ω ; useful to sync oscilloscope or to drive a counter or another oscillator. Single rear BNC connector serves as both input and output terminal.

Power: 100 to 125 and 200 to 250 V, 50 to 60 Hz, 36 W.

Mechanical: Bench or rack mount. **DIMENSIONS** (wxhxd): Bench, 19.75x5x13.06 in. (502x127x332 mm); rack, 19x3.47x11.44 in. (483x88x291 mm). **WEIGHT:** Bench, 26 lb (12 kg) net, 32 lb (15 kg) shipping; rack, 21 lb (10 kg) net, 27 lb (12 kg) shipping.

Description	Catalog Number
1316 Oscillator	1316-9700
Bench Model	1316-9701
Rack Model	

New Since
Catalog U

1238 Detector

- 10 Hz to 100 kHz
- 100-nV full-scale sensitivity
- magnitude, in-phase, and quadrature meters for rapid bridge balances
- excellent bridge detector

Designed for the difficult If you've ever had to extract a small signal from noise or to resolve a signal into its in-phase and quadrature components, you can appreciate the advantages of the 1238. With its high gain — 130 dB — and meters not only for magnitude of the input signal but for the in-phase and quadrature components as well, the 1238 lends itself handily to the most exacting applications.

This high-performance detector is attractive in other respects also, including 1-G Ω input impedance for minimum loading, overload protection against signals up to 200 V, and flat or tuned frequency response (with or without line-frequency rejection) to tailor the detector to your signal no matter how "tainted" it might be.

Excellent bridge detector In combination with a special oscillator, GR 1316, that supplies the necessary quadrature reference channels, this detector is superb for sensitive audio-frequency detection. The combination is specifically intended for use with the 1616 Precision Capacitance Bridge, enabling resolutions of one part in 10⁶ of 10 pF. Refer to the 1621 Precision Capacitance-Measurement System.

SPECIFICATIONS

Frequency: 10 Hz to 100 kHz, flat or tuned. **FLAT:** ± 5 dB from 10 Hz to 100 kHz. **TUNED:** Set by 4 in-line readout dials with $\pm 5\%$ of reading accuracy, 2 to 4% bandwidth, and second harmonic ≥ 30 dB down from peak. **LINE-REJECTION FILTER:** Reduces line level by ≥ 40 dB while signal is down 6 to 10 dB at 10 Hz from line frequency; filter can be switched out.

Signal Input from bridge or other source: Applied to rear BNC connector. **SENSITIVITY:** Also see curve; 100 nV rms typical for full-scale deflection at most frequencies, compression can be switched in to reduce full-scale sensitivity by 20 dB. **IMPEDANCE:** 1 G Ω \pm 20 pF. **MAXIMUM INPUT:** 200 V rms. **VOLTAGE GAIN:** ≈ 105 dB in flat mode, ≈ 130 dB in tuned mode, set by 12-position switch. **SPOT NOISE VOLTAGE:**

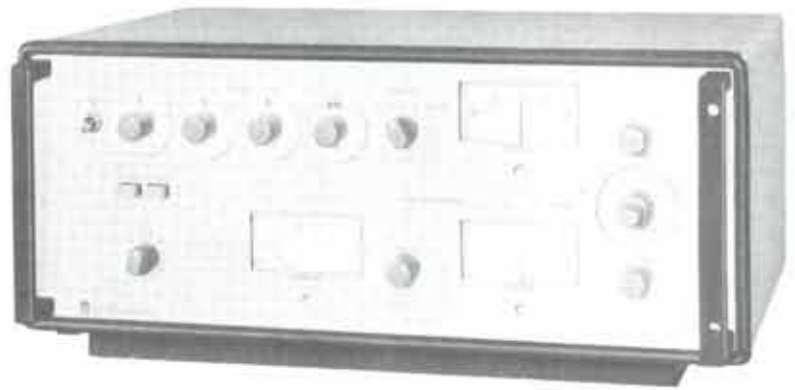
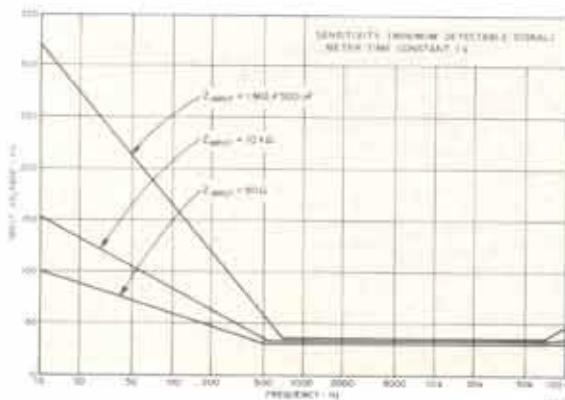

The 1238 Detector consists of a high-impedance low-noise preamplifier, a tuned amplifier, a compression amplifier, and two phase-sensitive detectors. Three panel meters provide the indications: one displays the magnitude of the input signal and two others simultaneously display its in-phase and quadrature components. The reference signals can be rotated continuously from 0 through 360° to ensure that the phase meters respond independently to the components of significance to you, for the most rapid bridge balances or signal analysis.

The effects of noise, hum, or any other input-signal contaminants are normally reduced or eliminated from your measurements by means of a tunable filter, line-rejection filter, and selectable time constants in the phase-sensitive detector circuits — all controlled from the front panel by the simple push of a button or turn of a knob.

— See **GR Experimenter** for October/December 1970.

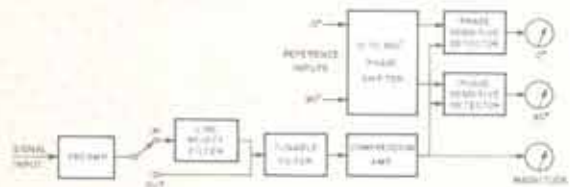

$< 30 \text{ nV} \times \sqrt{\text{bandwidth}}$, at 1 kHz with input impedance of 70 M Ω /500 pF. **MONITORED** by magnitude, in-phase, and quadrature meters; phase-sensitive detectors contain time-constant variable from 0.1 to 10 s in 5 steps.

Reference Inputs from oscillator: Applied to rear BNC connectors. Two ≥ 1 -V rms reference signals required, with 90° phase difference between them. **PHASE SHIFTER** rotates both references continuously from 0 to 360° and two verniers rotate each reference individually $\approx 10^\circ$.

Outputs: **MAIN AMPLIFIER:** 4 V rms (approx 2.3 V for full scale on Magnitude meter) available at rear BNC connector. **MAGNITUDE:** 6 V dc for full scale deflection; **PHASE DETECTORS:** Up to 1 V dc each for full scale deflection (depending on Sensitivity setting); available at rear 5-pin type 126 jack.

Environment: **TEMPERATURE:** 0 to +55°C operating, -40 to +75°C storage. **BENCH HANDLING:** 4 in. or 45° (MIL-810A-VI). **SHOCK:** 30 G, 11 ms (MIL-T-4807A-4.5-3A).

Required: Oscillator with 0 and 90° outputs; the 1316 Oscillator is recommended.

Power: 100 to 125 and 200 to 250 V, 50 to 60 Hz, 15 W.

Mechanical: Bench or rack models. **DIMENSIONS (wxhxd):** Bench, 19.56x6.66x12.94 in. (497x169x329 mm); rack, 19x5.22x13.06 in. (483x133x332 mm). **WEIGHT:** Bench, 27 lb (13 kg) net, 40 lb (19 kg) shipping; rack, 21 lb (10 kg) net, 34 lb (16 kg) shipping.

Description	Catalog Number
1238 Detector	
60-Hz Bench Model	1238-9700
60-Hz Rack Model	1238-9701
50-Hz Bench Model	1238-9703
50-Hz Rack Model	1238-9704



1620-A Capacitance-Measuring Assembly

- 10^{-5} pF to $11.1 \mu\text{F}$, 2- or 3-terminal
- 0.01% accuracy, 1-ppm resolution
- lever balance, in-line readout
- reads dissipation factor or conductance

The 1620-A is a self-contained assembly of the GR 1615-A Capacitance Bridge with appropriate oscillator and null detector for measurements at 11 frequencies between 20 Hz and 20 kHz. For applications requiring other or higher frequencies, to 100 kHz, the 1615-A bridge can be supplied separately and the oscillator and detector selected to meet your needs.

The 1620-A is intended for

- accurate and precise measurements of capacitance and dissipation factor
- measurement of circuit capacitances
- dielectric measurements
- intercomparison of capacitance standards differing in magnitude by as much as 1000:1

The 1615-A Capacitance Bridge brings to the measurement of capacitance, to the intercomparison of standards, and to the measurement of dielectric properties an unusual degree of accuracy, precision, range, and convenience.

High accuracy is achieved through the use of precisely wound transformer ratio arms and highly stable standards fabricated from invar and hermetically sealed in dry nitrogen. For calibration these standards can be intercompared.

Two- or Three-Terminal Connection Accurate three-terminal measurements can be made even in the presence of capacitances to ground as large as $1 \mu\text{F}$, as might be encountered with the unknown connected by means of long cables. The bridge has the necessary internal shielding to permit one terminal of the unknown capacitor to be directly grounded, so that true two-terminal and three-terminal measurements can both be made over the whole capacitance range.

Convenient Operation For both capacitance and dissipation factor, the balance controls are smoothly operating, lever-type switches. The readout is digital and the decimal point is automatically positioned. Each capacitance decade has a -1 position to facilitate rapid balancing.

The 1615 elementary diagram (facing) is also clearly delineated on the front panel of the bridge. Changes in connections and grounds are automatically indicated, as you switch the bridge terminals for different measurement conditions.

Extend Range to $11.1 \mu\text{F}$ With the 1615-P1 Range-Extension Capacitor, the 1615-A will measure to a maximum of $11.11110 \mu\text{F}$. This capacitor plugs into front-panel bridge terminals and can be adjusted for calibration to the bridge standards.

SPECIFICATIONS

Performance: Refer to the 1615 Bridge.

Frequency: 50, 60, 100, 120, 200, 400, 500, 1000, 2000, 5000, and 10,000 Hz. For use below 100 Hz, 1620-AP (with preamplifier) should be used for resolution beyond 0.01% or 0.01 pF.

Generator: 1311-A Oscillator.

Detector: 1232-A Tuned Amplifier and Null Detector. 1232-P2 Preamplifier added in 1620-AP.

Power: 105 to 125 or 210 to 250 V, 50 to 400 Hz, 22 W for oscillator. Null detector and preamplifier operate from internal battery, 9 Burgess Type E4 cells or equivalent.

Mechanical: Bench cabinet. DIMENSIONS (wxhxd): 19.75x19x11 in. (502x483x280 mm). WEIGHT: 59 lb (27 kg) net, 96 lb (44 kg) shipping.

Description	Catalog Number
Capacitance-Measuring Assembly	
1620-A, 115 V Ⓢ	1620-9701
1620-A, 230 V	1620-9702
1620-AP, with 1232-P2, 115 V	1620-9829
1620-AP, with 1232-P2, 230 V	1620-9830
Replacement Battery (9 used)	8410-1372

Ⓢ Federal stock numbers are listed before the Index.

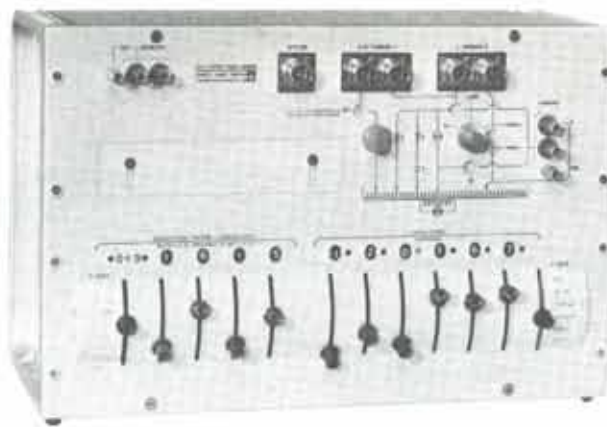

1615-A Capacitance Bridge

The 1615-A is an accurate, high-precision bridge for the measurement and intercomparison of standard capacitors, circuit component capacitors, or dielectric materials. It is available with oscillator and detector in the 1620 assembly. Or, to take full advantage of its wide frequency range, the bridge can be ordered separately for use with oscillator and detector especially selected for your purposes.



1615-P1



1615-P2

SPECIFICATIONS

RANGES

Capacitance, C, 10 aF to 1.11110 μF (10^{-17} to 10^{-4} farad) in 5 ranges, direct-reading, 6-figure resolution; least count 10^{-17} F (10 aF). With Range-Extension Capacitor, upper limit is 11.11110 μF.

Dissipation Factor, D, At 1 kHz, 0.000001 to 1, 4-figure resolution; least count, 0.000001 (10^{-6}); range varies directly with frequency.

Conductance, G, 10^{-8} μΩ to 100 μΩ, 2 ranges +, 2 ranges -, 4-figure resolution, least count 10^{-8} μΩ, independent of frequency; range varies with C range.

ACCURACY

At 1 kHz, $\pm(0.01\% + 0.00003 \text{ pF})$. At higher frequencies and with high capacitance, additional error is $[\pm 3 \times 10^{-4}\% + 2 (C_{\mu}) \times 10^{-4}\% \pm 3 \times 10^{-4} \text{ pF}] \times (f_{\text{MHz}})^2$.

At lower frequencies and with low capacitance, accuracy may be limited by bridge sensitivity.

Comparison accuracy, unknown to external standard, 1 ppm.

$\pm[0.1\% \text{ of measured value} + 10^{-6} (1 + f_{\text{MHz}} + 5 f_{\text{MHz}} C_{\mu})]$

$\pm[1\% \text{ of measured value} + 10^{-8} \mu\Omega + 6 \times 10^{-2} f_{\text{MHz}} C_{\mu} \times (1 + f_{\text{MHz}} + 5 f_{\text{MHz}} C_{\mu}) \mu\Omega]$

Standards: 1000, 100, 10, 1, 0.1, 0.01, 0.001, 0.0001 pF. Temperature coefficient of capacitance is less than 5 ppm/°C for the 1000-, 100-, and 10-pF standards, slightly greater for the smaller units.

Frequency: Approx 50 Hz to 10 kHz. Useful with reduced accuracy to 100 kHz. Below 100 Hz, resolution better than 0.01% or 0.01 pF requires preamplifier or special detector.

Generator: GR 1310-A or 1311-A oscillator recommended. Max safe generator voltage ($30 \times f_{\text{MHz}}$) volts, 300 V max. If gen-

erator and detector connections are interchanged, 150 to 500 V can be applied, depending on switch settings.

Detector: GR 1232-A Tuned Amplifier and Null Detector recommended. For increased sensitivity needed to measure low-loss small capacitors (on lowest C and D ranges simultaneously) at frequencies below 1 kHz, use 1232-AP or 1238 (with 1311 oscillator).

Supplied: 874-WO Open-Circuit Termination, 874-R22A Patch Cord, 274-NL Patch Cord.

Available: Type 1615-P1 RANGE-EXTENSION CAPACITOR; 1615-P2 COAXIAL ADAPTOR converts 2-terminal binding-post connection on 1615 bridge to GR900® Precision Coaxial Connector for highly repeatable connections and enables measurements with adaptor to be direct-reading by compensating for terminal capacitance.

Mechanical: Rack-bench cabinet. DIMENSIONS (wxhxd): Bench, 19x12.75x10.5 in. (483x324x267 mm); rack, 19x12.25x8.5 in. (483x311x217 mm); 1615-P1 (dia x ln): 3.06x4.87 in. (78x124 mm). WEIGHT: 39 lb (18 kg) net, 58 lb (27 kg) shipping.

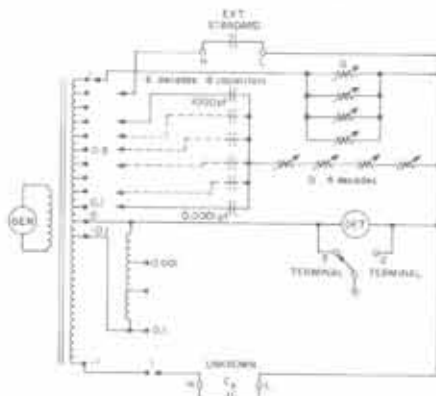

Elementary schematic diagram.

Description	Catalog Number
1615-A Capacitance Bridge	
Bench Model	1615-9801
Rack Model	1615-9811
1615-P1 Range-Extension Capacitor	1615-9601
1615-P2 Coaxial Adaptor, GR900 to binding posts	1615-9602

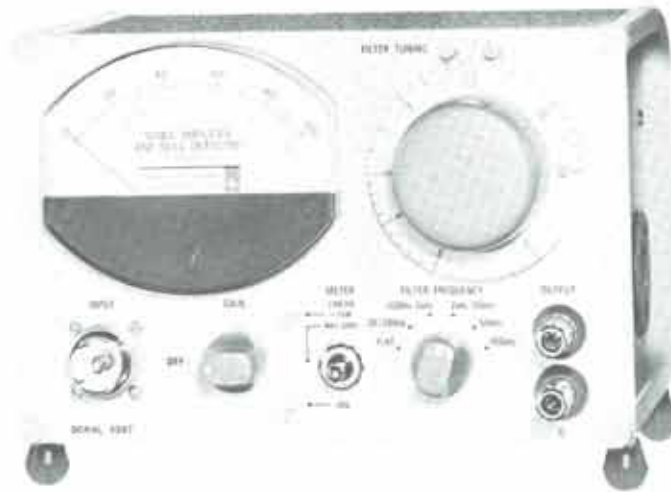

1232-A Tuned Amplifier and Null Detector

- 20 Hz to 20 kHz, 50 and 100 kHz
- 0.1- μV sensitivity
- bandwidth approx 5%
- 120-dB gain

A sensitive null detector like this is the key to many a fussy bridge measurement. Battery operation frees the 1232 from power-line noise and makes it ultra portable. Low-noise solid-state circuitry and high gain make it very sensitive. Its tunability and choice of bandwidth enable you to reject broadband noise as well as the harmonics that might otherwise impair good measurements. Here are its prime uses:

- bridge detector at audio frequencies; with the 1232-P2 Preamplifier it is equally sensitive for extremely high-impedance sources
- audio preamplifier and general-purpose, tunable, or broadband audio amplifier
- a-m detector for 0.5- to 500-MHz carrier frequencies, when used with an 874-VQ Voltmeter Detector
- sensitive audio wave analyzer for approximate measurements

SPECIFICATIONS

Frequency Response: TUNABLE FILTERS: 20 Hz to 20 kHz in 3 ranges; between 2% and 6% bandwidth to 15 kHz; 2nd harmonic at least 34 dB down from peak, 3rd at least 40 dB down; rejection filter on two highest ranges reduces 60-Hz level to at least 60 dB below peak response (50-Hz level is down >50 dB). Dial accuracy is $\pm 3\%$. FIXED-TUNED FILTERS: 50 kHz, 2nd harmonic is 44 dB down; 100 kHz . . . 53 dB down. FLAT RESPONSE: ± 3 dB from 20 Hz to 100 kHz.

Sensitivity: See plot. Typically better than 0.1 μV over most of the frequency range.

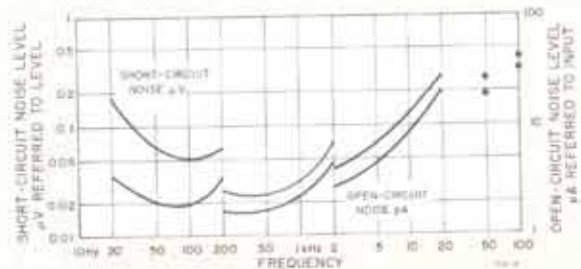
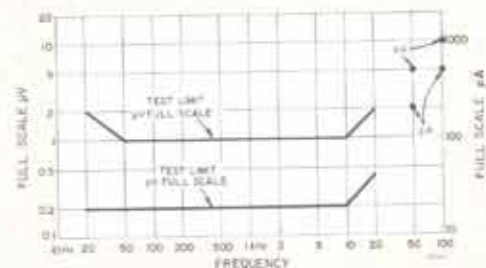

Performance. Upper: Specified sensitivity as input level for full scale indication, max gain, tuned. Lower: Typical noise level in terms of equivalent current and voltage sources.

Noise Level: REFERRED TO INPUT: See plot. Noise figure at 1 kHz is less than 2 dB at an optimum source impedance of 27 k Ω . REFERRED TO OUTPUT: Less than 5 mV on FLAT filter-frequency position, min gain setting, and -20-dB switch position; less than 50 mV in MAX SENS position.

Input: IMPEDANCE: Approx 50 k Ω at max gain; varies inversely with gain to 1 M Ω at min gain. MAX SAFE VOLTAGE: 200 V ac or 400 V dc.

Output: VOLTAGE GAIN: Approx 120 dB on the tunable ranges; 100 dB, flat range; 106 dB at 50 kHz; 100 dB at 100-kHz position. LEVEL: 1 V into 10 k Ω when meter indication is full scale. INTERNAL IMPEDANCE: 3 k Ω . METER LINEARITY: dB differences are accurate to $\pm 5\%$ ± 0.1 division for inputs of less than 0.3 V. COMPRESSION (meter switched to LOG): Reduces fullscale sensitivity by 40 dB. Does not affect bottom 20% of scale. ATTENUATION (meter switched to -20 dB): Linear response with 20-dB less gain than MAX SENS.

Distortion (filter switch in FLAT position): <5% (due to meter rectifiers).

Terminals: Input, GR874 \oplus coaxial connector; output, binding posts.

Available: 1232-P2 Preampifier to maintain sensitivity of

1232-A at low frequencies when operating from a source impedance above 100 k Ω ; rack-adaptor sets (see below) convert 1232 alone, or with companion instruments, to 19-in. rack-mount width.

Power: 12 V dc, from 9 mercury (M72) cells in series. Est battery life 1500 hours. Optionally, a rechargeable battery (non-mercury) can be supplied on special order.

Mechanical: Convertible bench cabinet. DIMENSIONS (wxhxd): 5.75 lb (2.6 kg) net, 8 lb (3.7 kg) shipping.

Description	Catalog Number
1232-A Tuned Amplifier and Null Detector \oplus	1232-9701
1232-AP Tuned Amplifier and Null Detector, with preamplifier	1232-9829
Rack-Adaptor Sets	
480-P308, for 1232-A alone	0480-9838
480-P316, for 1232-A with 1310 or 1311 oscillator or similar 8-in. wide instrument with convertible-bench cabinet	0480-9836
480-P317, for 1232-AP (with preamp) and companion 8-in. instrument	0480-9837
Replacement Battery, 9 req'd	8410-1372

1232-P2 Preampifier

The 1232-P2 has particular application to measurements with the 1615-A Capacitance Bridge. It increases sensitivity for measurements made at frequencies well below 1000 Hz if the bridge is set to both its lowest C and D (not G) ranges simultaneously. Low-frequency measurement of small samples of dielectric materials can be made more accurately with the addition of this preampifier.

SPECIFICATIONS

Voltage Gain: Approx 0.7.

Noise (referred to input): Open-circuit equivalent 0.1 pA; short-circuit equivalent, 0.3 μ V (when used with Type 1232-A tuned to 100 Hz).

Impedances: INPUT: >100 m Ω in parallel with 70 pF. OPTIMUM SOURCE: 3 M Ω . OUTPUT: 10 k Ω .

Connectors: GR874 \oplus on cables, input and output.



1232-P2 Preampifier installed.

Power: 12 V, 200 μ A, supplied by 1232-A.

Mechanical: Special cabinet. DIMENSIONS (wxhxd): 0.75x6x7.5 in. (19x152x190 mm). WEIGHT: 0.94 lb (0.43 kg) net, 4 lb (1.9 kg) shipping.

Description	Catalog Number
1232-P2 Preampifier	1232-9602

1240 Bridge Oscillator-Detector



The 1232-A Tuned Amplifier and Null Detector and the 1311-A Audio Oscillator have been combined for use with audio-frequency bridges and other null-balance devices. This assembly occupies a minimum of bench space and is supplied with removable panel extensions, which adapt it for rack mounting.

The oscillator supplies 11 fixed frequencies from 50 Hz to 10 kHz. The detector is tunable continuously from

20 Hz to 20 kHz, with additional spot frequencies of 50 kHz to 100 kHz. The assembly is also available with the 1232-P2 Preampifier included.

SPECIFICATIONS

Power: Null detector, internal battery; oscillator, 105 to 125 or 210 to 250 V, 50 to 400 Hz, 22 W max.

Mechanical: Cabinets bolted together. DIMENSIONS (wxhxd): 19x6x7.75 in. (483x153x197 mm), including panel extensions for rack mounting. WEIGHT: 13.5 lb (7 kg) net, 28 lb (13 kg) shipping.

Description	Catalog Number
1240-A Bridge Oscillator-Detector, 115 V	1240-9701
1240-A Bridge Oscillator-Detector, 230 V	1240-9711
1240-AP Bridge Oscillator-Detector, with preampifier, 115 V	1240-9829
1240-AP Bridge Oscillator-Detector, with preampifier, 230 V	1240-9839
ASA type M72 Replacement battery (for 1232, 9 req'd)	8410-1372

\oplus Federal stock numbers are listed before the Index.

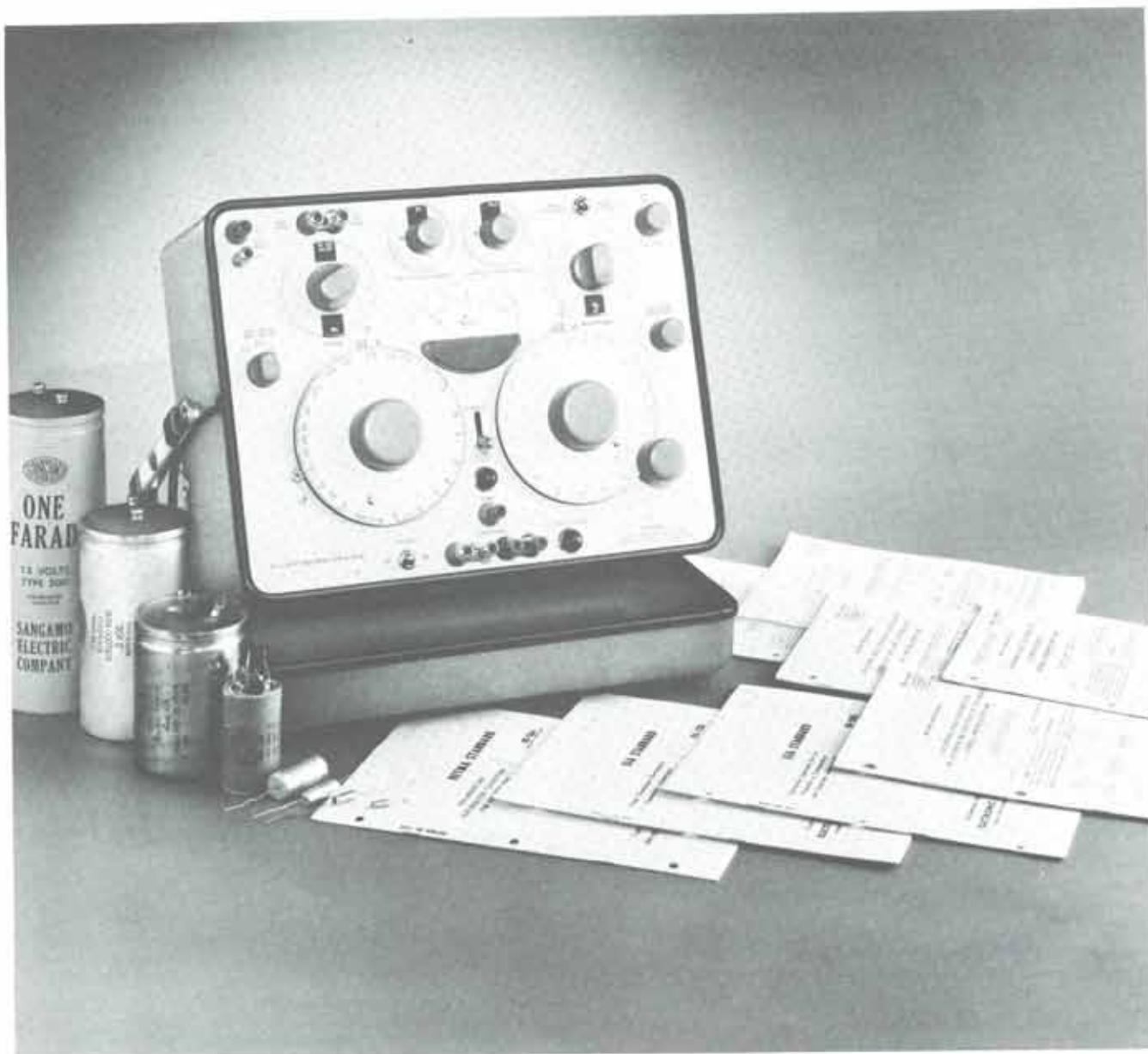

1617-A Capacitance Bridge

- 1 pF to 1.1 farads
- 20 Hz to 1 kHz
- 1% accuracy
- 2-, 3-, or 4-terminal connections

Self-Contained bridge The 1617-A was specifically designed for measuring capacitance, dissipation factor, and leakage current of electrolytic capacitors, but it will also find considerable use as a general-purpose 1% bridge. It is completely self-contained, including a 120-Hz generator, null detector, dc polarizing-voltage supply, and metering for bias voltage and leakage current. At frequencies other than 120 Hz, use an external oscillator.

Multiterminal connections An unknown capacitor can be connected to the bridge by means of three- or four-terminal connections, as well as the usual two-terminal. The four-terminal connection permits accurate measure-

ment of large capacitance by reducing the effect of the resistance and inductance of leads and connections. Correct measurements of small capacitances are assured by the three-terminal connection, which reduces the effect of stray lead capacitance. A multiterminal configuration is necessary for accurate measurement of capacitors connected by long cables leading, for instance, from the bridge on a nearby bench into an environmental test chamber.

This bridge includes an Orthonull® balance finder, which speeds up measurements of high-dissipation-factor capacitors by eliminating troublesome sliding balance. The operator's safety is enhanced by warning lights indicating the presence of voltage on the bridge terminals.

Electrolytics The 1617 Capacitance Bridge is designed especially for measuring large-valued capacitors like those in table, as well as other electrolytic types, most of which require the special measurement conditions prescribed by MIL or EIA specifications:

Specification and Capacitor Type	Frequency	AC Level	Accuracy		DC Polarizing Voltage
			C	Loss	
MIL C-3965-C MIL C-39006-A Tantalum Foil and Sintered Slug Capacitors	120 ± 5 Hz	Less than 30% of DCWV or 1 V, pk, whichever is smaller (Less than 1V rms for 39006A)	2%	R or P.F. 2% (P.F. 2% for -39006A)	C—Sufficient for no reversal of polarity. D—"Polarized Capacitance Bridge" Sum of ac and dc shall not exceed DCWV (Less than 2.2 V for 39006A)
MIL C-26655-B MIL C-39003 Solid Tantalum Capacitors MIL C-39018 Aluminum Oxide Capacitors	120 ± 5 Hz	Limited to 1V, rms	2%	D, 10% (2% for -39003 and -39018)	C—Max bias 2.2 V. D—"Polarized Bridge", 2.2-V dc max.
RS 228 Tantalum Electrolytic Capacitors	120 Hz	Small enough not to change value	±2½%	D, 5%	Optional
MIL C-62 B Polarized Aluminum Capacitors	120 ± 5 Hz	Limited to 30% of DCWV or 4 V, whichever is smaller	2%	D, 2%	No bias required if ac voltage less than 1 V. However, if bias causes differences, measurements with bias shall govern.
RS 154 B Dry Aluminum Electrolytic Capacitors	120 Hz	Small enough not to change value	±2½%	R or RC	Optional, but if substantial difference occurs, rated dc should be used.
RS 205 Electrolytic Capacitors for use in Electronic Instruments	120 Hz	Small enough not to change value	±2½%	D	Optional

SPECIFICATIONS

Quantity	Frequency	Range	Accuracy *
Capacitance	120 Hz internal	0 to 0.11 F	±1% ±1 pF, smallest division 2 pF; residual ("zero") capacitance approx 4 pF
		0.11 F to 1.1 F	±2%
	40 Hz to 120 Hz external (useful down to 20 Hz with reduced accuracy)	0 to 1.1 F	Same as above with suitable generator
	120 Hz to 1 kHz external	0 to $\left(\frac{100}{f_m}\right)^2$ F	±1% ±1 pF with suitable generator and precautions
Dissipation Factor	120 Hz internal or 40 Hz to 120 Hz	0 to $10 \frac{f_m}{120}$	±0.001 ±0.01 C ±2% †
	120 Hz to 1 kHz	0 to 10	(±0.001 ±0.01 C) $\frac{f_m}{120}$ ±2% †

†Additional error (due to lead resistance) for 4-terminal measurements: For C < 1%, for D < 0.01, if each lead has < 1 Ω of resistance, except on the highest measurement range the corresponding lead resistance is 0.1 Ω.
* C is expressed in farads.

Frequency: INTERNAL TEST SIGNAL: 120 Hz (synchronized to power line) for 60-Hz model; 100 Hz for 50-Hz model. Phase reversible. Amplitude selected by switch to be 0.2, 0.5, or 2 V max. EXTERNAL TEST SIGNAL: 20 Hz to 1 kHz. (See table for C range.)

Dc Bias Voltage: Internal power supply and meter: 0 to 600 V in 6 ranges. Meter accuracy: ±3% of full scale. External bias limit: 800 V max.

Bias Current (from internal source): ≈ 15 mA max. **METER:** Range, 0 to 20 mA in 6 ranges; resolution, 0.5 μA (first range); accuracy, ±3% of full scale.

Required, for measurements at frequencies other than twice the line: An oscillator such as the 1311 for spot frequencies or the 1310 for continuous coverage.

Supplied: 4-lead and shielded 2-lead cable assemblies.

Power: 105 to 125 V or 210 to 250 V, 18 W. Both 50 and 60-Hz models.

Mechanical: Flip-Tilt case and rack mount. **DIMENSIONS** (wxhxd): Portable, 16.25x15x9 in. (413x381x229 mm); rack, 19x14x6.13 in. (483x356x155 mm). **WEIGHT:** Portable: 26 lb (12 kg) net, 34 lb (16 kg) shipping; rack, 28 lb (13 kg) net, 43 lb (20 kg) shipping.

Description	Catalog Number
1617 Capacitance Bridge	
Portable Model (115 V, 60 Hz)	1617-9701
Portable Model (230 V, 60 Hz)	1617-9285
Portable Model (115 V, 50 Hz)	1617-9206
Portable Model (230 V, 50 Hz)	1617-9266
Rack Model (115 V, 60 Hz)	1617-9820
Rack Model (230 V, 60 Hz)	1617-9296
Rack Model (115 V, 50 Hz)	1617-9216
Rack Model (230 V, 50 Hz)	1617-9276
Patent Number 2,872,639.	



1690-A Dielectric Sample Holder

- micrometer-electrode-type for dielectric disks
- wide frequency range; fits many instruments
- calibration corrects for fringing and strays
- stable mounting, complete shielding

The 1690-A is a sample-holder of the Hartshorn and Ward type,* used for the measurement of dielectric constant, dissipation factor, and volume resistivity of 2-inch-diameter (or smaller) disks of dielectric material, in accordance with ASTM test method D-150. It is suitable for any flat sample whose largest diameter is not over 2 inches and whose thickness is not over 0.3 inch.

The holder can be used with resonant circuits for susceptance-variation or frequency-variation measurements and with capacitance bridges, slotted lines, megohmmeters, etc.

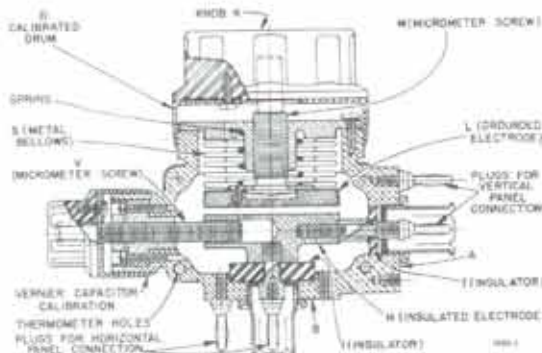

A precision micrometer screw, M, with large instrument knob, K, drives the movable grounded electrode, L, with respect to a fixed, insulated electrode, H. An accurately divided drum, D, indicates the electrode spacing. The micrometer screw is electrically shunted by a metal bellows, S, to assure a positive, low-resistance connection.

* L. Hartshorn and W. H. Ward, *Proceedings of the Institution of Electrical Engineers*, Vol. 79, pp. 597-609 (1936).

A release mechanism automatically disengages the drive to prevent damage when the electrodes are in contact. The movable electrode adjusts itself to the plane of the specimen surface.

The vernier capacitor with micrometer screw, V, is for use in the susceptance-variation method of measurement, and for precise C balance with low-loss samples.

The assembly is mounted in a rugged aluminum casting, B, which shields it on four sides. Two removable cover plates, which permit access to the electrodes, complete the shielding. The holder can be mounted on either horizontal or vertical panels.

SPECIFICATIONS

Electrodes: Diameter, 2.000 in. ± 0.0025 in. Surfaces ground optically flat within a few wavelengths.

Electrode Spacing: Adjustable from zero to 0.3 in., indicated by micrometer reading in mils.

Vernier: Incremental capacitance is 5 pF, nominal.

Calibration: For main capacitor, a chart gives calculated air capacitance as a function of spacing. Correction curve gives the measured deviations from calculated values over range from 0.300 to 0.010 in. (300 to 10 mils). In accordance with recommended ASTM practice, calibration is referred to the calculated geometric value at a spacing of 100 mils. Accuracy is $\pm 0.02\% \pm 0.1$ mill-inch.

For vernier capacitor, correction chart is provided, from which capacitance differences can be determined to an accuracy of ± 0.004 pF.

Zero Capacitance: Approx 11 pF.

Operating Temperature: Up to 100°C.

Frequency: No significant error occurs at frequencies below 100 MHz.

Supplied: 1690-P1 Adaptor Assembly for mounting to 1615-A and 716-C Capacitance Bridges; hardware for mounting sample holder on 1644-A Bridge and 1862-C Megohmmeter.

Available: 900-Q874 ADAPTOR to 900-LB Precision Slotted Line.

Mechanical: Carrying and storage case supplied. DIMENSIONS (wxhxd): 6.25x5.75x4.5 in. (159x146x114 mm). WEIGHT: 3.75 lb (1.7 kg) net, 13 lb (6 kg) shipping.

Description	Catalog Number
1690-A Dielectric Sample Holder	1690-9701

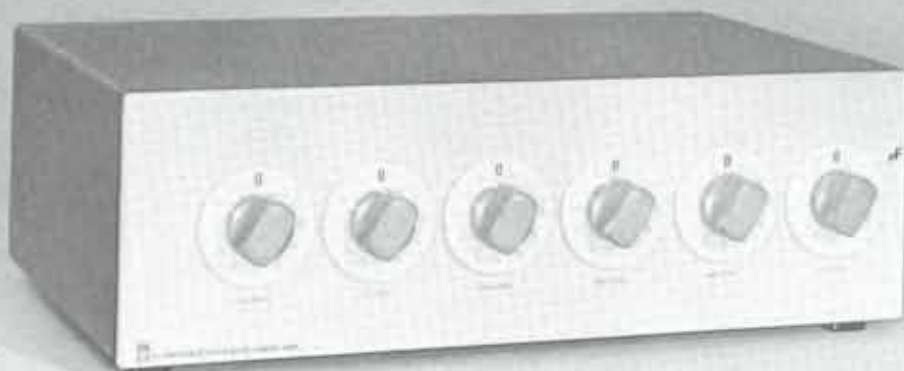

1413 Precision Decade Capacitor

- 0 to $>1 \mu\text{F}$
- 0.05% basic accuracy
- 6-digit resolution
- 3-terminal connections
- provision for BCD output

The 1413 is not only a precision standard, it is a systems component as well — connections are made at the rear and each decade provides contact closures for 1-2-4-8 BCD output. It is an excellent companion to the 1654 Impedance Comparator, with which it is combined in 1654-Z Sorting Systems.

SPECIFICATIONS

Range: 0 to 1.11111 μF , controlled by six in-line-readout dials.

Accuracy: $\pm(0.05\% + 0.5 \text{ pF})$ at 1 kHz.

Stability: $\pm(0.01\% + 0.1 \text{ pF})$ per year. TEMPERATURE COEFFICIENT: $\approx 20 \text{ ppm}/^\circ\text{C}$ from 10 to 50°C.

Zero Capacitance: $<0.1 \text{ pF}$.

Voltage Rating: 500 V pk max up to 10 kHz.

Frequency: See curves.

	1 pF to 100 pF	101 pF to 1000 pF	1001 pF to 2000 pF	2001 pF to 0.1 μF	0.1 μF to 1.11111 μF
Dissipation Factor, max at 1 kHz	0.002	0.001	0.0005	0.0003	0.0004
Insulation Resistance, 3 term., after 2 min at 500 V dc	$>5 \times 10^{10} \Omega$				$>5 \times 10^9 \Omega$
Terminal Capacitance, max					
high to case	4 pF	8 pF	10 pF	30 pF	60 pF
high to guard	85 pF	110 pF	125 pF	165 pF	200 pF
low to guard	45 pF	70 pF	80 pF	110 pF	120 pF

Interface: CONNECTIONS: 2 rear-mounted GR874® locking connectors. DATA OUTPUT: 36-pin Amphenol Type 57 connector provides connections to 1-2-4-8 weighted BCD contacts rated at 28 V, 1 A, on each decade switch.

Available: 0480-9703 RACK-ADAPTOR SET to convert bench models to rack models, 874-Q2 ADAPTOR to convert GR874 connector to binding posts (2 req'd), 938-L SHORTING LINK to connect shields together when 874-Q2 Adaptors are used, 4220 3036 CONNECTOR to mate with Data Output Connector.

Six precision decades are employed to provide a range of 0 to 1.11111 μF in increments as small as 1 pF and with an accuracy of 0.05% + 0.5 pF. Air capacitors are used for the two lower decades and precision silvered-mica capacitors are used for the remainder. The lower four decades contain adjustments that are factory set but accessible for readjustment later if desired.

The shielding is divided into two parts, arranged to provide low terminal-to-guard capacitances and low detector input capacitance in order to reduce errors with the 1654. When the two shields are connected together, the 1413 becomes a well-shielded three-terminal capacitor with an extremely low zero capacitance, suitable for a variety of applications.

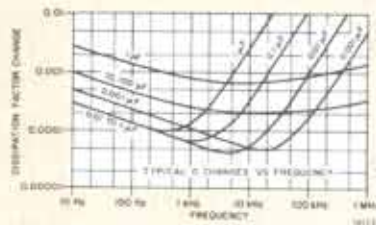
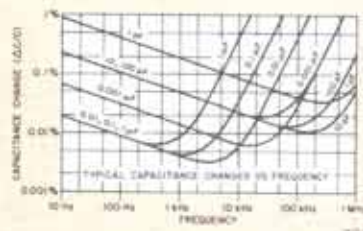

Mechanical: Convertible-bench cabinet. DIMENSIONS (wx hxd): Bench, 17x5.59x11.96 in. (432x142x304 mm); rack, 19x5.22x10.9 in. (483x133x277 mm). WEIGHT: Bench, 23 lb (11 kg) net, 29 lb (14 kg) shipping; rack, 24 lb (11 kg) net, 30 lb (14 kg) shipping.

Description	Catalog Number
1413 Precision Decade Capacitor	
Bench Model	1413-9700
Rack Model	1413-9701
Rack-Adaptor Set	0480-9703

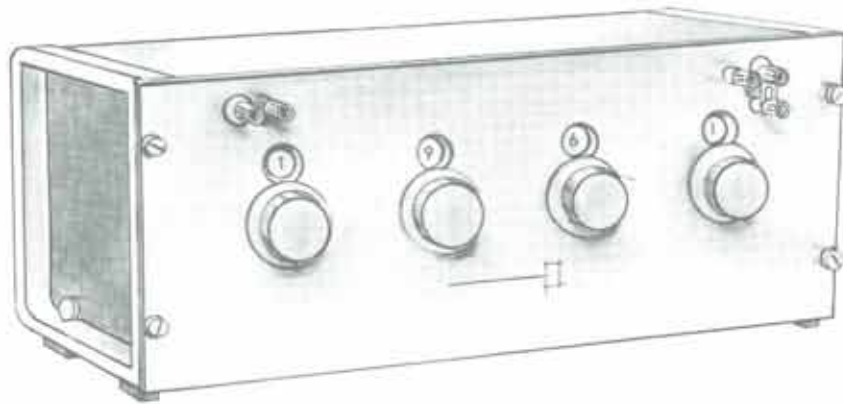

1423-A Precision Decade Capacitor

- 100 pF to $> 1 \mu\text{F}$
- $\pm 0.05\%$ accuracy
- two- or three-terminal connection

This capacitor is a versatile tool for calibration laboratories and production-line testing. With it a bridge can be standardized to an accuracy exceeded only by that of the highest quality, individually certified laboratory standards such as the GR 1404 Reference Standard Capacitors. Used with a limit bridge, such as the GR 1654 Impedance Comparator, the 1423 facilitates fast and accurate production-line measurements of arbitrary capacitance values with minimum setup time.

Any value of capacitance from 100 pF to $1.111 \mu\text{F}$, in steps of 100 pF, can be set on the four decades and will be known to an accuracy of 0.05%. The terminal capacitance values are set precisely to the nominal value and can be readjusted later at calibration intervals, if necessary, without disturbance of the main capacitors.

The 1423 consists of four decades of high-quality silvered-mica capacitors similar to those used in the GR 1409 Standard Capacitors. The capacitors and associated switches are mounted in an insulated metal compartment, which in turn is mounted in a complete metal cabinet. This double-shielded construction ensures that capacitance at the terminals is the same for either the three-terminal or the two-terminal method of connection (except for a constant difference of about one picofarad). This external capacitance can be included in the two-terminal calibration by the adjustment of a single trimmer.

SPECIFICATIONS

Nominal Values: 100 pF to $1.111 \mu\text{F}$ in steps of 100 pF.

Accuracy: $\pm(0.05\% + 0.05\text{pF})$ at 1 kHz, calibrated in the three-terminal connection. Two-terminal connection (capacitor inserted into Type 777-Q3 Adaptor) adds about 1.3 pF.

Stability: $\pm(0.01\% + 0.05\text{pF})$ per year.

Certificate: A certificate is supplied certifying that each component capacitor was adjusted by comparison, to a precision better than $\pm 0.01\%$, with working standards whose absolute

values are known to an accuracy typically $\pm 0.01\%$, determined and maintained in terms of reference standards periodically calibrated by the National Bureau of Standards.

Frequency: See curves for typical variation of capacitance and dissipation factor with frequency.

(Top) Change in capacitance as a function of frequency. These changes are referred to the values that the capacitors would have if there were neither interfacial polarization nor series inductance. The 1-kHz value on the plot should be used as a basis of reference in estimating frequency errors. (Bottom) Dissipation factor as a function of frequency.

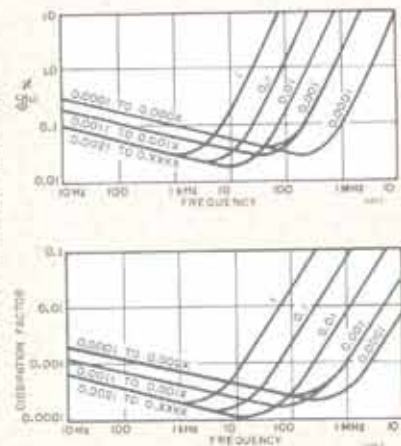

Dissipation Factor: Not greater than 0.001, 0.0005, and 0.0003 for capacitances of 100 to 1000 pF, 1100 to 2000 pF, and 2100 pF to $1.1110 \mu\text{F}$, respectively.

Temperature Coefficient of Capacitance: Approx $+20$ ppm per degree between 10° and 50°C .

Insulation Resistance: $>5 \times 10^{10} \Omega$ to $0.1 \mu\text{F}$ and $>5 \times 10^9 \Omega$ from $0.1 \mu\text{F}$ to $1.111 \mu\text{F}$.

Maximum Voltage: 500 V peak, up to 10 kHz.

Supplied: Two Type 777-Q3 Adaptors.

Mechanical: Rack-bench cabinet. DIMENSIONS (w \times h \times d): Bench, 19 \times 7.25 \times 10.5 in. (483 \times 184 \times 267 mm); rack, 19 \times 7 \times 8.5 in. (483 \times 178 \times 216 mm). WEIGHT: 26 lb (12 kg) net, 39 lb (18 kg) shipping.

Description	Catalog Number
1423-A Precision Decade Capacitor	
Bench Model \rightarrow	1423-9801
Rack Model	1423-9811

\rightarrow Federal stock numbers are listed before the Index.

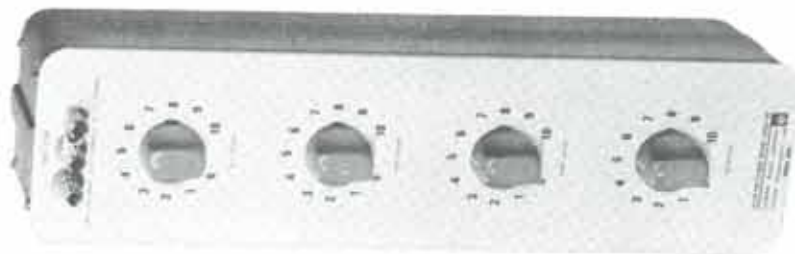

1419 Decade Capacitors

- 100 pF to 1.1 μ F
- choice of models
- two- or three-terminal connection

Type 1419 Decade Capacitors are offered in three models using two different dielectric materials to satisfy a variety of needs.

Types 1419-A and -B (Polystyrene) Capacitance and dissipation factor constant with frequency, essentially noninductive, very low dielectric absorption. The di-

electric is specially prepared of purified high-molecular-weight polystyrene, having very high resistance and freedom from interfacial polarization. Moisture sealing with Teflon* feed-through insulators assures high performance under adverse humidity conditions.

Type 1419-K (Silvered Mica) Higher accuracy, low dissipation factor, and $+35 \pm 10$ ppm/ $^{\circ}$ C temperature coefficient (10-50 $^{\circ}$ C) for use in higher ambient temperatures.

* Registered trademark of E. I. duPont de Nemours and Company.

SPECIFICATIONS

Type Number	1419-A [⊕]	1419-B [⊕]	1419-K [⊕]
Dielectric	Polystyrene	Polystyrene	Silvered Mica
Maximum Capacitance of Box (μ F)	1.110	1.1110	1.110
In Steps of (μ F)	0.001	0.0001	0.001
Dials	3	4	3
Zero Capacitance, typical			
2-terminal connection	37 pF	50 pF	41 pF
3-terminal connection	15 pF	20 pF	13 pF
Accuracy ¹			
2-terminal connection ¹	$\pm 1\%$	$\pm(1\% + 2 \text{ pF})$	$\pm 0.5\%$
3-terminal connection	$\pm 1\%$ except $\pm 1.5\%$ on smallest decade	$\pm 1\%$ or $-(2\% + 4 \text{ pF})$	$\pm 0.5\%$ except $\pm 1\%$ on smallest decade
Dissipation Factor at 1 kHz		< 0.0002	< 0.0003
Insulation Resistance at 100 V, 25 $^{\circ}$ C, 50% RH, typical		$> 10^{12} \Omega$	$> 5 \times 10^{11} \Omega$
Max Voltage* (dc or peak)		500 V up to 35 kHz	500 V up to 10 kHz
Max Operating Temperature (C)		65 $^{\circ}$	75 $^{\circ}$
Voltage Recovery*		$< 0.1\%$	$< 3\%$
Resonant Frequencies (typical)		1 μ F—400 kHz; 0.1 μ F—1MHz; 0.01 μ F—2.7 MHz; 0.001 μ F—7.8 MHz; 0.0001 μ F—23 MHz	
Dc Cap/1-kHz Cap		< 1.001	Typically 1.03
Cabinet: Lab-bench			
Over-all Dimensions — in. (mm)	13 x 4.31 x 5 (330 x 110 x 127)	16.3 x 4.31 x 5 (415 x 110 x 127)	14.13 x 5.5 x 6 (359 x 140 x 153)
Net Weight — lb (kg)	8.38 (3.8)	10.5 (4.8)	11.25 (5.5)
Shipping Weight — lb (kg)	10 (4.6)	11 (5)	18 (8.5)
Catalog Number	1419-9701	1419-9702	1419-9711

¹ Capacitance increments from zero position are within this percentage of the indicated value for any setting at 1 kHz.

² Units are checked with switch mechanism high, electrically, and the common lead and case grounded.

³ At frequencies above the indicated max, the allowable voltage decreases and is (approx) inversely proportional to frequency. These limits correspond to a temperature of 40 $^{\circ}$ C at max setting of each decade in box.

* Final % of settling voltage V measured after holding terminal voltage at V for 1 h, then discharging for 10 s through a resistance of V ohms.

[⊕] Federal stock numbers are listed before the index.



Type 1424-A.

1424 Decade Capacitor

- Polystyrene stability
- Paper economy

Type 1424-A Polystyrene capacitors, combined in 10 $1\text{-}\mu\text{F}$ units, are housed in two hermetically sealed, non-ferrous metal cases with Teflon[®]-insulated high terminals, the cases being the common (LOW) terminal. The aluminum outer cabinet and panel are insulated from both capacitor terminals, so that either two- or three-terminal connections can be used.

Residual series inductance and resistance have been minimized by the use of current-sheet conductors, ribbon leads, and multiple switch contacts.

[†] Registered trademark of E. I. duPont de Nemours and Company.

SPECIFICATIONS

Accuracy: Refer to the table.

Certificate: 1424-A: A certificate is supplied giving measured values obtained by comparison, to a precision better than $\pm 0.01\%$, with working standards whose absolute values are known to an accuracy better than $\pm 0.05\%$, determined and maintained in terms of reference standards periodically measured by the National Bureau of Standards. 1424-M: A certifi-

cate is supplied, certifying the accuracy of adjustment in terms of reference standards, periodically measured by the National Bureau of Standards.

Frequency Characteristics: Calibration and adjustment are made at 1 kHz. Plots of typical change in capacitance and dissipation factor with frequency are given in the calibration certificate.

Type	1424-A [⊗]
Total Capacitance	10 μF
Capacitance per Step	1 μF
Dielectric	Polystyrene
Adjustment Accuracy at 1 kHz	$\pm 0.25\%$
Stability	$\pm 0.05\%$ /year
Dissipation Factor at 1 kHz	< 0.0003
Insulation Resistance	$> 10^8 \Omega\text{F}$
Voltage Recovery*	$< 0.1\%$
Temp Coefficient of Capacitance (typical) ppm/°C	-140
Max Operating Temperature °C	65
Max Safe Voltage	500 V, peak, below 10 kHz
Dimensions Width, height, depth; inches (mm)	9.5, 7.75, 8 (242, 197, 204)
Net Weight lb (kg)	16.5 (7.5)
Shipping Weight lb (kg)	19 (9)
Catalog Number	1424-9701

* Dielectric absorption.

[⊗] Federal stock numbers are listed before the Index.

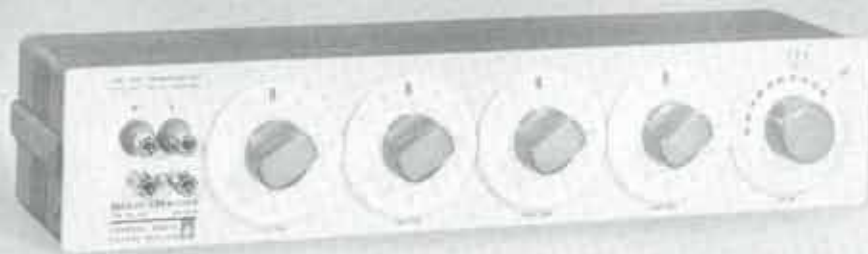

1412-BC Decade Capacitor

- 50 pF to $>1 \mu\text{F}$
- better than 1-pF resolution
- accuracy $\pm(0.5\% + 5 \text{ pF})$
- low loss, leakage, dielectric absorption

The wide capacitance range and high resolution of this decade capacitance box make it exceptionally useful in both laboratory and test shop. Owing to its fine adjustment of capacitance, it is a convenient variable capacitor to use with the 1654 Impedance Comparator. The poly-

styrene dielectric used in the decade steps is necessary for applications requiring low dielectric absorption and constancy of both capacitance and dissipation factor with frequency.

Four decades of polystyrene capacitors and a variable air capacitor are used, mounted in a double-shield box. The double shielding provides 2-terminal and 3-terminal capacitances that are the same except for the capacitance between the terminals. The variable air capacitor with a linear ΔC of 100 pF and a resolution of better than 1 pF provides continuous adjustment between the 100-pF steps of the smallest decade.

SPECIFICATIONS

Capacitance: 50 pF to 1.11115 μF in steps of 100 pF with a 0- to 100-pF variable air capacitor providing continuous adjustment with divisions of 1 pF. Capacitances for 2- and 3-terminal connections differ by about 1 pF (C_{12} in the drawing). C_{10} is approx 125 pF.

Min Capacitance: 50 pF with all controls set at zero.

Dielectric: Polystyrene for decade steps.

Accuracy: $\pm(0.5\% + 5 \text{ pF})$ at 1 kHz for total capacitance including 50-pF minimum for the 3-terminal connection.

Temperature Coefficient: $-140 \text{ ppm}/^\circ\text{C}$ (nominal).

Frequency Characteristics: Dc Cap/1-kHz Cap <1.001 . At higher frequencies the increase is approx $\Delta C/C = (f/f_0)^2$. The resonant frequency, f_0 , varies from over 400 kHz for a capacitance of 1 μF to about 27 MHz for a capacitance of 150 pF when connections are made to the front terminals. f_0 is about 300 kHz and 70 MHz for rear connections and the same capacitances.

Max Operating Temperature: 65°C.

Dielectric Absorption (Voltage Recovery): 0.1% max.

Dissipation Factor: 150 to 1000 pF, 0.001, max, at 1 kHz; over 1000 pF, 0.0002, max, at 1 kHz.

Insulation Resistance: 10^9 ohms, min.

Max Voltage: 500 V peak, up to 35 kHz.

Terminals: Four 938 Binding Posts with grounding link are provided on the panel. Two of the binding posts are connected to the case and located for convenient use with patch cords in 3-terminal applications. Access is also provided to rear terminals for relay-rack applications.

Mechanical: Lab-bench cabinet; brackets provided for rack mounting. DIMENSIONS (wxhxd): 17.25x3.5x6 in. (439x89x153 mm). WEIGHT: 8.5 lb (3.9 kg) net, 10 lb (4.6 kg) shipping.

The double shielding used in the 1412-BC Decade Capacitor keeps C_{10} very small. This capacitance is the difference between the 3-terminal and 2-terminal capacitance of the box; C_{10} is approx 125 pF.

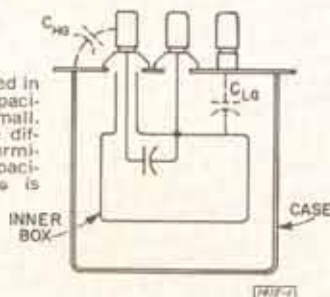

Description

1412-BC Decade Capacitor

Catalog

Number

1412-9410



1422 Precision Capacitors

- variable air capacitors
- stability: better than 0.02% full scale per year
- settable to 40 ppm
- low temperature coefficient, low losses
- wide selection to suit needs

The 1422 is a stable and precise variable air capacitor intended for use as a continuously adjustable standard of capacitance.

One of the most important applications is in ac bridge measurements, either as a built-in standard or as an external standard for substitution measurements. It is available in a variety of ranges, terminal configurations, and scale arrangements to permit selection of precisely the required characteristics.

Two-Terminal The 1422-D is a dual-range, two-terminal capacitor, direct reading in total capacitance at the terminals. For convenience in making substitution measurements, two 1422's have scales reading in capacitance removed, i.e., the capacitance is maximum at the zero reading. These, the 1422-MD and 1422-ME, are also dual-range, two-terminal capacitors.

Three-terminal The 1422-CB, -CL, and -CD are three-terminal capacitors with shielded coaxial terminals for use in three-terminal measurements. The calibrated direct capacitance is independent of terminal capacitances to ground, and losses are very low. The 1422-CL has particularly low, constant terminal capacitances, making it suitable for measurement circuits in which high capacitance to guard cannot be tolerated.

Construction The capacitor assembly is mounted in a cast frame for rigidity. This frame and other critical parts are made of aluminum alloys selected to give the strength of brass with the lightness of aluminum. The plates of most models are also aluminum, so that all parts have the same temperature coefficient of linear expansion.

A worm drive is used to obtain high precision of setting. To avoid eccentricity, the shaft and the worm are accurately machined as one piece. The worm and worm wheel are also lapped into each other to improve smoothness. The dial end of the worm shaft runs in a self-align-

ing ball bearing, while the other end is supported by an adjustable spring mounting, which gives positive longitudinal anchoring to the worm shaft through the use of a pair of sealed, self-lubricating, preloaded ball bearings. Similar pairs of preloaded ball bearings provide positive and invariant axial location for the main or rotor shaft. Electrical connection to the rotor is made by means of a silver-alloy brush bearing on a silver-overlay drum to assure a low-noise electrical contact.

Stator insulation in all models is a cross-linked thermo-setting modified polystyrene having low dielectric losses and very high insulation resistance. Rotor insulation, where used (Types 1422-CB and -CL), is grade L-4 stearite, silicone treated.

Accuracy The errors tabulated in the specifications are possible errors, i.e., the sum of error contributions from setting, adjustment, calibration, interpolation, and standards. When the capacitor is in its normal position with the panel horizontal, the actual errors are almost always smaller. The accuracy is improved when the readings are corrected using the 12 calibrated values of capacitance given on the correction chart on the capacitor panel and interpolating linearly between calibrated points. Even better accuracy can be obtained from a precision calibration of approximately 100 points on the capacitor dial, which permits correction for slight residual eccentricities of the worm drive and requires interpolation over only short intervals. This precision calibration is available for all models at an extra charge. Models so calibrated are listed with the additional suffix letter, P, in the type number. A plastic-enclosed certificate of calibration is supplied, giving corrections to one more figure than the tabulated accuracy.

SPECIFICATIONS

Accuracy: See table.

Stability: Capacitance change with time <1 scale division (0.02% of full scale) per year. Long-term accuracy can be estimated from the stability and the initial accuracy.

Calibration: Measured values (supplied) are obtained by comparison at 1 kHz, with working standards whose absolute values are known to an accuracy of $\pm(0.01\% + 0.0001 \text{ pF})$. Each comparison is made to a precision better than $\pm 0.01\%$.

Type 1422		Two-Terminal						Three-Terminal			
		-D		-MD		-ME		-CB	-CL	-CD	
CAPACITANCE RANGE, pF	Min	100	35	0	0	0	0	50	10	0.5	0.05
	Max	1150	115	1050	105	105	10.5	1100	110	11	1.1
SCALE, pF/Division:		0.2	0.02	0.2	0.02	0.02	0.002	0.2	0.02	0.002	0.0002
INITIAL ACCURACY: \pm Picofarads Direct-Reading (Adjustment): Total Capacitance		0.5*	0.1*	Differences from Zero				0.6	0.1	0.04	0.008
Capacitance Difference		1.2	0.2	1	0.2	0.2	0.05	1.2	0.2	0.08	0.016
With Corrections from Calibration Chart (supplied): Total Capacitance		0.3*	0.04*					0.3	0.04	0.01	0.002
Capacitance Difference†		0.6	0.08	0.6	0.08	0.08	0.02	0.6	0.08	0.02	0.004
With Corrections from Precision Calibration (extra charge): Total Capacitance		0.1*	0.01*					0.1	0.01	0.001	0.0002
Capacitance Difference†		0.2	0.02	0.2	0.02	0.02	0.004	0.2	0.02	0.002	0.0004
RESIDUALS (typical values): Series Inductance, μ H		0.06	0.10	0.06	0.10	0.06	0.10	0.14	0.13	0.17	0.17
Series Resistance, ohms at 1 MHz		0.04	0.05	0.04	0.05	0.04	0.05	0.1	0.1		
Terminal Capacitance, pF, typical:		high terminal to case		min scale				36	34	98	25
				max scale				35	33	74	23
		low terminal to case		min scale				58	58	117	115
				max scale				53	55	92	93
Capacitance at Zero Scale Setting, pF, typical:		1140	135	145	35						

* Total capacitance is the capacitance added when the capacitor is plugged into a 777-Q3 Adaptor.
† Divide error by 2 when one setting is made at a calibrated point.

The values of the working standards are determined and maintained in terms of reference standards periodically calibrated by the National Bureau of Standards.

The indicated value of total capacitance of a two-terminal capacitor is the capacitance added when the 1422 Capacitor is plugged into a 777-Q3 Adaptor. The uncertainty of this method of connection is approx ± 0.03 pF.

Resolution: Dial can be read and set to 1/5 of a small division, i.e., to 0.004% of full scale. **BACKLASH:** Negligible for any setting reached consistently from lower scale readings; <0.004% of f s, for settings reached from alternate directions.

Temperature Coefficient: Approx +20 ppm/°C, for small temperature changes.

Residual Parameters: See table. Series resistance varies as \sqrt{f} , for $f > 100$ kHz; negligible, for $f < 100$ kHz.

Frequency Characteristic: 2-terminal models, see curves. 3-terminal models: 20, 40, and 60 MHz (approx) resonant frequency for 1422-CB, -CL, and -CD (each section), respectively.

Dissipation Factor: 2-terminal, loss primarily in stator supports of low-loss polystyrene (the product $DC \approx 10^{-11}$). 3-terminal, estimated $D < 20 \times 10^{-4}$; except, for 1422-CD, $< 10 \times 10^{-4}$. **INSULATION RESISTANCE:** $> 10^{11} \Omega$, under standard conditions (23°C, RH < 50%).

Max Voltage: 1000 V pk (all models).

Terminals: 2-TERMINAL MODELS: Jack-top binding posts at standard (0.75-in.) spacing. Rotor terminal connected to panel and shield. 3-TERMINAL MODELS: Locking GR874® coaxial connectors.

Required: For 3-terminal models, two GR874 Patch Cords, or equivalent.

Available: For 2-terminal models, 777-Q3 Adaptor. (See "Calibration," above.)

¹ John F. Hersh, "A Close Look at Connection Errors in Capacitance Measurements," *General Radio Experimenter*, July 1959.

⊕ Federal stock numbers are listed before the Index.

Mechanical: Lab-bench cabinet. DIMENSIONS (wxhxd): 9.5x 7x8.5 in. (242x178x216 mm). WEIGHT (depending on model): 10.5 to 12.5 lb (4.8 to 5.7 kg) net, 15 lb (7 kg) shipping.

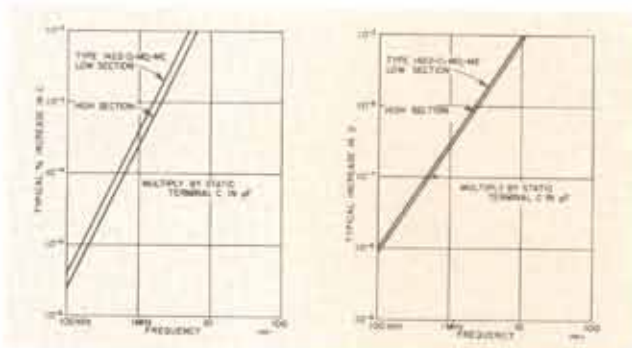

Variation with frequency of effective capacitance and dissipation factor per pF of capacitance for two-terminal 1422 Precision Capacitors.

Description	Catalog Number
Precision Capacitors	
with precision calibration (≈ 100 points)	
1422-DP	1422-9904
1422-MDP	1422-9913
1422-MEP	1422-9955
1422-CBP	1422-9902
1422-CLP	1422-9508
1422-CDP	1422-9925
with standard calibration (12 points)	
1422-D ⊕	1422-9704
1422-MD	1422-9854
1422-ME ⊕	1422-9855
1422-CB ⊕	1422-9916
1422-CL	1422-9933
1422-CD ⊕	1422-9823

New Since
Catalog U



1408 standard, for use with an oil bath.



1408 standard, with temperature-controlled air bath.

1408 Reference Standard Capacitors

- 10 pF, 100 pF
- high stability
- low voltage coefficient
- fused-silica dielectric

Ultra-high stability The continuously improving accuracy of capacitor calibrations by the National Bureau of Standards brings a better knowledge of capacitance to standards laboratories — provided, of course, the laboratories have adequate reference standards. The 1408 Reference Standard Capacitors, with their high stability, are suitable for calibration in parts in 10^7 . The 1616 Precision Capacitance Bridge is highly recommended for accurate calibration of a wide range of working standards from such a reference.

More extensively equipped laboratories are offered the economy of a unit designed for use in a temperature-controlled oil bath. Laboratories that lack a facility can take advantage of the built-in, temperature-controlled air bath of a second version. Two capacitance values are available, 10 pF and 100 pF, and either or both can be ordered in the air-bath version.

Fused-silica dielectric The active elements of the capacitors are gold, deposited on a substrate of fused silica — noted for exceptional stability, low loss, and relative independence of frequency. The plated substrate is mounted in a brass cell which is then sealed in a stainless-steel case containing dry nitrogen.

Air-Bath Version This unit includes one or two standards, as desired, plus a self-contained air bath whose temperature is held constant to within 0.01°C per year to assure the utmost stability of the standards. Since it carries its own environment, it is well adapted for use in laboratories without an oil bath or closely-controlled ambient temperature or in portable laboratories and calibration centers. The air bath operates from 12 volts so that it is an easy matter to transport it under power at all times.

Oil-Bath Version This unit is for laboratories that want to use the standard in a temperature-controlled oil bath. Two values are available, 10 pF and 100 pF, and each offers the same high precision and stability.

—See *GR Experimenter* for October/December 1970.

SPECIFICATIONS

Nominal Values: 10 pF and 100 pF.

Calibration: A certificate of calibration is supplied with each capacitor, giving the measured direct capacitance at 1 kHz and at a specified temperature near 25°C for an oil-bath capacitor or near 30°C for an air-bath capacitor. The measured value is obtained by comparison to a precision better than 0.1 ppm with standards whose values are determined and maintained by periodic calibrations made by the National Bureau of Standards. The limit of uncertainty of these calibrations is ± 0.5 ppm.

Adjustment Accuracy: ± 100 ppm.

Stability: Estimated to be better than 0.3 ppm/yr.

Environment: TEMPERATURE COEFFICIENT, $12 \text{ ppm} \pm 2 \text{ ppm}/^\circ\text{C}$. TEMPERATURE CYCLING, from U to 60°C , $< 1 \text{ ppm}$ hysteresis at 30°C .

Air-Bath Characteristics: TEMPERATURE, 30°C nominal with stability of $0.01^\circ\text{C}/\text{year}$, $< 0.005^\circ\text{C}/\text{hour}$ if ambient temperature is kept within 1°C . TEMPERATURE COEFFICIENT: $0 \pm 0.05 \text{ ppm}/^\circ\text{C}$ from 17 to 29°C ambient temperature. Thermometer well provided for calibration.

Electrical: DISSIPATION FACTOR, $< 10^{-9}$ at 1 kHz. VOLTAGE, 500 V max. RESIDUAL IMPEDANCES:

		LH, LL	CD	CH	CL
air	10 pF	0.6 μH	10 pF	88 pF	64 pF
	100 pF	0.6 μH	100 pF	120 pF	96 pF
oil	10 pF	0.2 μH	10 pF	55 pF	31 pF
	100 pF	0.2 μH	100 pF	87 pF	23 pF

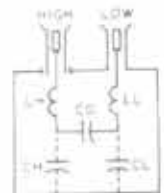

Terminals: Two gold-plated GR874® locking connectors, easily adapted to other common connector types (on air-bath version, connectors can be moved to rear).

Available: GR874 ADAPTORS, 874-R22LA PATCH CORDS.

General: Fused-silica dielectric; plated substrate is hermetically sealed in a dry-nitrogen-filled stainless-steel case. Connections to the air-bath version can be made to the front or the rear as your application dictates. A 12-volt input is provided to maintain a constant air-bath temperature even while the unit is in transit.

Power (Air-bath version only): 100 to 120 or 200 to 240 V, 50 to 60 Hz, 5 W; 12 V at 0.4 A for dc operation, battery connectors provided on rear.

Mechanical: DIMENSIONS (wxhxd): Air-bath version 8.42x8.72x16 in. (214x222x407 mm); oil-bath version, 3.5x11.1x

1.86 in. (89x283x48 mm). **WEIGHT:** Air-bath version (single value), 23 lb (11 kg) net, 32 lb (15 kg) shipping; (two values), 25 lb (12 kg) net, 34 lb (16 kg) shipping; oil-bath version, 3 lb (1.4 kg) net, 7 lb (3.2 kg) shipping.

Description	Catalog Number
Reference Standard Capacitor, air bath	
1408, 10 pF	1408-9700
1408, 10/10 pF	1408-9702
1408, 100 pF	1408-9703
1408, 100/100 pF	1408-9705
1408, 10/100 pF	1408-9706
Reference Standard Capacitor, oil bath	
1408-A, 10 pF	1408-9701
1408-B, 100 pF	1408-9704



1404 Reference Standard Capacitor

- 10, 100, 1000 pF
- 20 ppm/year stability
- 3-terminal, coaxial connections
- hermetically sealed in dry nitrogen

These capacitors have been designed as primary reference standards of capacitance with which working standards can be compared. The 1615-A Capacitance Bridge is particularly well suited for this purpose and can be

conveniently used to calibrate accurately a wide range of working standards in terms of a 1404 Reference Standard Capacitor. A single 1000- or 100-picofarad standard is also the only standard necessary to calibrate the bridge itself.

In combination with an accurately known external resistor, this capacitor becomes a standard of dissipation factor.

All critical parts of the plate assembly are made of Invar for stability and low temperature coefficient. After heat cycling and adjustment, the assembly is mounted in a heavy brass container, which, after evacuation, is filled with dry nitrogen under pressure slightly above atmospheric and sealed. The container is mounted on an aluminum panel and protected by an outer aluminum case. Each capacitor is subjected to a series of temperature cycles to determine hysteresis and temperature coefficients and to stabilize the capacitance.

Two locking GR874® coaxial connectors are used as terminals. The outer shell of one is connected to the case, but the outer shell of the other is left unconnected to permit the capacitor to be used with an external resistor as a dissipation-factor standard.

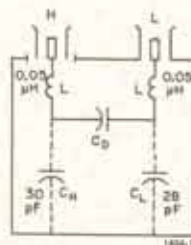

Equivalent circuit showing direct capacitance, C_0 , and average values of residual inductance, L , and average values of terminal capacitances, C_H and C_L . $C_0 = 1000$ pF for 1404-A, 100 pF for 1404-B, and 10 pF for 1404-C.

SPECIFICATIONS

Calibration: A certificate of calibration is supplied with each capacitor, giving the measured direct capacitance at 1 kHz and at $23^{\circ} \pm 1^{\circ}\text{C}$. The measured value is obtained by a comparison to a precision better than ± 1 ppm with working standards whose absolute values are known to an accuracy of ± 5 ppm, determined and maintained in terms of reference standards periodically measured by the National Bureau of Standards.

Adjustment Accuracy: The capacitance is adjusted before calibration with an accuracy of ± 5 ppm to a capacitance about 5 ppm above the nominal value relative to the capacitance unit maintained by the General Radio reference standards.

Stability: Long-term drift is less than 20 parts per million per year. Maximum change with orientation is 10 ppm and is completely reversible.

Temperature Coefficient of Capacitance: 2 ± 2 ppm/ $^{\circ}\text{C}$ for 1404-A and -B; 5 ± 2 ppm/ $^{\circ}\text{C}$ for 1404-C, from -20°C to $+65^{\circ}\text{C}$. A measured value with an accuracy of ± 1 ppm/ $^{\circ}\text{C}$ is given on the certificate.

Temperature Cycling: For temperature cycling over range from -20°C to $+65^{\circ}\text{C}$, hysteresis (retraceable) is less than 20 ppm at 23°C .

Dissipation Factor: Less than 10^{-3} at 1 kHz.

Residual Impedances: See equivalent circuit for typical values of internal series inductances and terminal capacitances.

Max Voltage: 750 V.

Terminals: Two locking GR874 coaxial connectors; easily convertible to other types of connectors by attachment of locking adaptors. Outer shell of one connector is ungrounded to permit capacitor to be used with external resistor as a dissipation-factor standard.

Required: For connection to 1615-A Capacitance Bridge, 2 Type 874-R20A or 874-R22LA Patch Cords.

Mechanical: Lab-bench cabinet. DIMENSIONS (wxhxd): 6.75x6.63x8 in. (172x169x204 mm). WEIGHT: 8.5 lb (3.9 kg) net, 14 lb (6.4 kg) shipping.

Description	Catalog Number
Reference Standard Capacitor	
1404-A, 1000 pF	1404-9701
1404-B, 100 pF	1404-9702
1404-C, 10 pF	1404-9703

1405 Coaxial Capacitance Standards

- 1 and 10 pF
- rf standards
- GR900[®] connectors



Extending the available values of rf capacitance downward, the 1405 standards permit impedance-measuring instruments to be calibrated at even higher frequencies accurately and with traceability to the National Bureau of Standards.

Accuracy is stated two ways. The first refers to nominal capacitance and includes initial adjustment, aging, and other effects. The second refers to the individual calibration and certificate.

SPECIFICATIONS

Calibration: A certificate of calibration is supplied with each unit, giving the measured capacitance at 1 kHz and at a specified temperature and relative humidity. The measured capacitance is the capacitance at the reference plane of the GR900 connector. This value is obtained by comparison, to a precision better than ± 0.002 pF, with working standards whose

absolute values are known to an accuracy typically $\pm 0.02\%$, determined and maintained in terms of reference standards periodically calibrated by the National Bureau of Standards.

	1405-B, 10 pF	1405-E, 1 pF
Accuracy at 23°C	$\pm 0.2\%$ (0.02 pF)	$\pm 0.5\%$ (0.005 pF)
Calibration Accuracy	$\pm 0.04\%$	$\pm 0.2\%$
Stability		
vs temperature, $10\text{--}70^{\circ}\text{C}$	$-0.004\%/^{\circ}\text{C}$	$-0.01\%/^{\circ}\text{C}$
vs humidity, $<90\%$ RH	—	$+0.005\%/ \text{RH}$
vs aging	$<0.1\%/ \text{yr}$	$<0.3\%/ \text{yr}$
Frequency		
0.1% C increase	40 MHz	120 MHz
10% C increase	0.4 GHz	1.7 GHz
Residuals		
D at 1 kHz, $<50\%$ RH	$<150 \times 10^{-4}$	$<100 \times 10^{-4}$
Insulation R	$>10^{11} \Omega$ at 23°C and $<50\%$ RH	
equivalent L	1.6 nH at <250 MHz	1.8 nH at <500 MHz
Peak Volts	1 kV	3 kV

Available: ADAPTORS 1615-P2 for calibrating with GR 1615 bridge and 900-Q9 for connecting standard to $\frac{1}{4}$ -inch x 28 threaded stud (GR 938 Binding Post) or tapped hole.

Terminal: GR900 precision coaxial connector.

Mechanical: DIMENSIONS (dia x h): 1.06x2.32 in. (27x59 mm). WEIGHT: 4 oz (103 g) net, 5 oz (142 g) shipping.

Description	Catalog Number
Coaxial Capacitance Standards	
1405-B, 10 pF	1405-9703
1405-E, 1 pF	1405-9700

* Federal stock numbers are listed before the Index.

1406 Coaxial Capacitance Standards

- stable to 0.05% per year
- for rf impedance calibrations
- 50 pF through 1000 pF

The 1406 Coaxial Capacitance Standards are stable, low-loss air capacitors with small, stable and known series inductance. Use them for the accurate, traceable calibration of high-frequency bridges and other impedance-measuring instruments.

Instrument calibration The 1406 standards can be connected directly to instruments, such as the 1616 Precision Capacitance Bridge, equipped with GR900® precision connectors and to others through appropriate adaptors. Series inductance and resistance have been kept to a minimum in the 900-Q9 Adaptor. When other adaptors are used, these quantities should be known to permit correcting for their effects at high frequencies.

These standards can be calibrated at audio frequencies with the 1616 bridge or with the 1615 Capacitance Bridge and the 1615-P2 Coaxial Adaptor. Each has an adjustment for compensating for terminal capacitance, to permit direct-reading measurements.

Repeatable coaxial connection GR900 precision coaxial connectors are used, for stability and repeatable performance that have been proven in use at frequencies as high as 9 GHz. The use of coaxial connectors also meets high-frequency calibration requirements of the National Bureau of Standards.

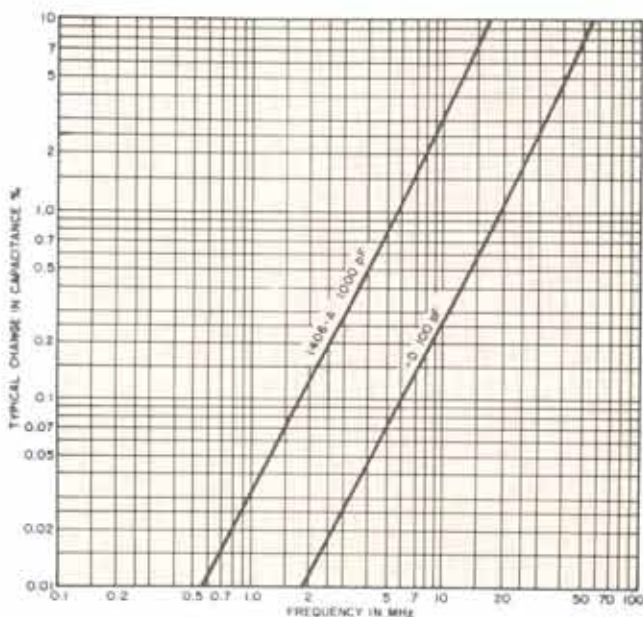

Typical percent increase in capacitance with frequency of 1406 Coaxial Capacitance Standards.



SPECIFICATIONS

Calibration: A certificate of calibration is supplied with each unit, giving the measured capacitance at 1 kHz and at a specified temperature and relative humidity. The measured capacitance is the capacitance at the reference plane of the GR900 connector. This value is obtained by comparison, to a precision better than $\pm 0.01\%$, with working standards whose absolute values are known to an accuracy typically $\pm 0.01\%$, determined and maintained in terms of reference standards periodically calibrated by the National Bureau of Standards.

Typical Parameters

Nominal Capacitance	Peak Volts	Dissipation Factor		Inductance
		1 kHz (40% RH)	1 MHz	
1000 pF	700	3×10^{-4}	50×10^{-4}	8.6 nH
100 pF	1500	30×10^{-4}	20×10^{-4}	7.6 nH

Accuracy: Capacitance adjusted by GR to nominal value $\pm 0.1\%$. **STABILITY:** Capacitance change $< 0.05\%$ per year. **TEMPERATURE COEFFICIENT** of capacitance: Typically 10 to 20 ppm/°C, between 20 and 70°C.

Residual Impedances: See table. Dissipation factor varies as the 3/2 power of frequency above about 100 kHz. Insulation resistance $> 10^{12} \Omega$, at 23°C and relative humidity $< 50\%$.

Terminal: GR900 precision coaxial connector.

Available: 1615-P2 Adaptor for convenience in calibrating with 1615-A Capacitance Bridge. 900-Q9 Adaptor for connecting the 1406 to 0.25-in. x 28 threaded studs, tapped holes, or GR 938 Binding Posts spaced 0.75 to 1 in. apart.

Mechanical: Cylindrical case. DIMENSIONS (dia x h): 3.06 x 5.25 in. (78 x 134 mm). WEIGHT: 1.5 lb (0.7 kg) net, 4 lb (1.9 kg) shipping.

Description	Catalog Number
Coaxial Capacitance Standard	
1406-A, 1000 pF	1406-9701
1406-D, 100 pF	1406-9704
1615-P2 Coaxial Adaptor, GR900 to 1615 Bridge	1615-9602
900-Q9 Adaptor, GR900 to binding posts	0900-9874

1407 Coaxial Capacitance Standard



- stable to 0.01% per year
- rf standards with GR900® connectors

The 1407 Coaxial Capacitance Standards are fixed mica capacitors of very high stability with small, stable, and known series inductance. This, and the use of precision coaxial connectors, enables the 1407 standards to be used in the calibration of high-frequency bridges and other impedance-measuring instruments.

SPECIFICATIONS

Calibration: A certificate of calibration is supplied with each unit giving the measured capacitance at 1 kHz and at a specified temperature. The measured value is the capacitance at the reference plane of the GR900 connector. This value is obtained by comparison to a precision better than $\pm 0.005\%$ with working standards whose absolute values are known to an accuracy typically $\pm 0.01\%$, determined and maintained in terms of reference standards periodically calibrated by the National Bureau of Standards.

Stability: The capacitance change is less than 0.01% per year.

Accuracy: Within $\pm 0.05\%$, at 1 kHz, of the nominal capacitance.

Temperature Coefficient of Capacitance: $+20 \pm 10$ ppm/ $^{\circ}\text{C}$, between 10 and 70 $^{\circ}\text{C}$.

Dissipation Factor: 50×10^{-4} (typical) at 1 kHz and 23 $^{\circ}\text{C}$. Max values given in table. Measured D at 1 kHz to an accuracy of ± 0.00005 and D-vs-frequency curves given in certificate.

Series Inductance: 7 nH, typical.

Insulation Resistance: Minimum of 5000 ohm-farads or 100 G Ω , whichever is the lesser, when measured at 500 V dc after two minutes electrification.

Max Voltage: 500 V pk, up to 10 kHz.

Terminal: GR900 precision coaxial connector.

Mechanical: Cylindrical case. DIMENSIONS (dia x h): 3x4.75 in. (77x121 mm). WEIGHT: 1.25 lb (0.6 kg) net, 4 lb (1.9 kg) shipping.

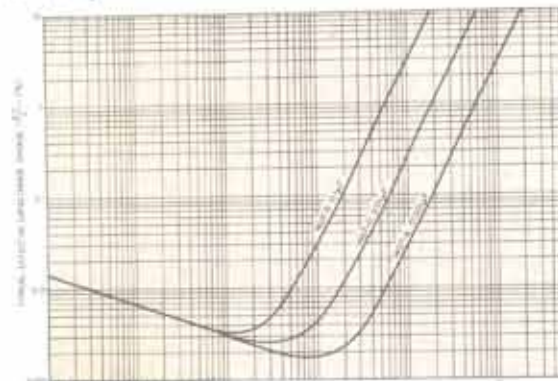

The 1-kHz value is used as a reference point in indicating change in capacitance with frequency.

Description	Nominal Capacitance	Max D at 1 kHz and 23 $^{\circ}\text{C}$	Catalog Number
Coaxial Capacitance Standard			
1407-A	0.001 μF	0.00030	1407-9700
1407-D	0.01 μF	0.0002	1407-9703
1407-G	0.1 μF	0.0002	1407-9706

1403 Standard Air Capacitor



- 1000 pF to 0.001 pF
- calibration accuracy: $\pm 0.02\% \pm 0.01$ fF

The 1403 Standard Air Capacitors are stable, three-terminal standards in decimal values from 0.001 to 1000 pF. Their terminals are arranged to plug directly into the External Standard and Unknown terminals of the 1615 and 1616 capacitance bridges.

SPECIFICATIONS

Calibration: A certificate of calibration is supplied with each unit giving the measured capacitance at 1 kHz and at a specified temperature. The measured value is the direct capacitance between shielded terminals when the capacitor has at least one lead completely shielded and its case connected to a guard point. This value is obtained by comparison, to a precision better than $\pm(0.01\% + 0.00001 \text{ pF})$, with working standards whose absolute values are known to an accuracy typically $\pm 0.01\%$, determined and maintained in terms of reference standards periodically calibrated by the National Bureau of Standards.

Stability: Capacitance change is less than 0.05% per year.

Residual Impedances: See curve for effect of frequency. Capacitance from either terminal to case is ≈ 30 pF.

Dissipation Factor: $< 20 \times 10^{-4}$ max at 1 kHz and 50% or less relative humidity.

Peak Voltage: 1500 V, except 700 V for 1403-A.

Temperature Coefficient of Direct Capacitance: Typically 20 to 40 ppm per degree between 20 $^{\circ}$ and 70 $^{\circ}\text{C}$. The larger coefficients apply to the smaller capacitance values.

Terminals: GR874® coaxial connectors, for complete shielding of the leads. SPACING: 1.13 in (28.6 mm).

Mechanical: Cylindrical case. DIMENSIONS (dia x h): 3.06x 5.25 in. (77x133 mm). WEIGHT: 1 lb (0.5 kg) net, 4 lb (1.9 kg) shipping.

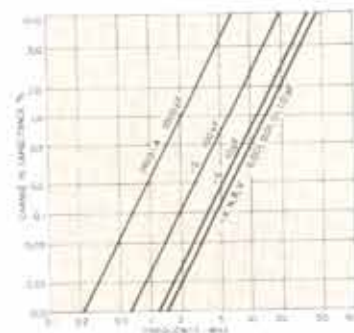

Typical increase (percent) in effective direct capacitance, with frequency produced by residual inductance.

Description	Nominal Capacitance	Adjustment Accuracy	Catalog Number
Standard Air Capacitor			
1403-A	1000 pF	0.1%	1403-9701
1403-D	100	0.1	1403-9704
1403-G	10	0.1	1403-9707
1403-K	1.0	0.1	1403-9711
1403-N	0.1	0.1	1403-9714
1403-R	0.01	0.3	1403-9718
1403-V	0.001	1.0	1403-9722

Ⓢ Federal stock numbers are listed before the Index.



GR 1409-T



GR 1409-Y

1409 Standard Capacitors

- 0.001 to 1 μF
- $\pm 0.01\%$ /year stability
- calibration accuracy $\pm 0.02\%$
- two- and three-terminal calibration provided

The 1409 Standard Capacitors are fixed mica capacitors of very high stability for use as two- or three-terminal reference or working standards in the laboratory.

Typical capacitors, observed over more than 15 years, have shown random fluctuations of less than $\pm 0.01\%$ in measured capacitance with no evidence of systematic drift.

These capacitor units consist of a silvered-mica and foil pile, spring-held in a heavy metal clamping structure for mechanical stability. The units are selected for low dissipation factor and are stabilized by heat cycling. They are housed, with silica gel to provide continuous desiccation, in cast aluminum cases, sealed with high-temperature potting wax. A well is provided in the wall of the case for the insertion of a dial-type thermometer. Three jack-

top binding posts are provided on the top of the case and removable plugs on the bottom, for convenient parallel connection without error.

SPECIFICATIONS

Adjustment Accuracy: Within $\pm 0.05\%$ of the nominal capacitance value (two-terminal) marked on the case.

Calibration: A certificate of calibration is supplied with each unit, giving both two- and three-terminal measured capacitances at 1 kHz and at a specified temperature. The measured value is the capacitance added when the standard is plugged directly into General Radio binding posts. This value is obtained by comparison, to a precision better than $\pm 0.01\%$, with working standards whose absolute values are known to an accuracy typically $\pm 0.01\%$, determined and maintained in terms of reference standards periodically calibrated by the National Bureau of Standards.

Stability: Capacitance change is less than 0.01% per year.

Temperature Coefficient of Capacitance: $+35 \pm 10$ ppm per degree C between 10° and 70°C.

Dissipation Factor: Less than 0.0003 at 1 kHz and 23°C (see curves). Measured dissipation factor at 1 kHz is stated in the certificate to an accuracy of ± 0.00005 .

Series Inductance: Typically 0.050 μH for 1409-F and -L, 0.055 μH for -T and -Y.

Series Resistance at 1 MHz: 0.02 ohm, except for 1409-Y, which is 0.03 ohm.

Frequency Characteristics: See curves. Series resistance varies as the square root of the frequency for frequencies above 100 kHz.

Approx Terminal Capacitance: From H terminal to case (G), 12 to 50 pF. From L terminal (outside foils of capacitor) to case, 300 to 1300 pF.

Leakage Resistance: 5000 ohm-farads or 100 G Ω , whichever is the lesser.

Max Voltage: 500 V pk up to 10 kHz.

Mechanical: Sealed case. DIMENSIONS (wxhxd): 1409-Y, 3.25x5.63x2.69 in. (83x143x69 mm); others, 3.25x4x2 in. (83x102x51 mm). WEIGHT: 1.25 lb (0.6 kg) net, 4 lb (1.9 kg) shipping; the 1409-Y is heavier by approx 1 lb (0.5 kg).

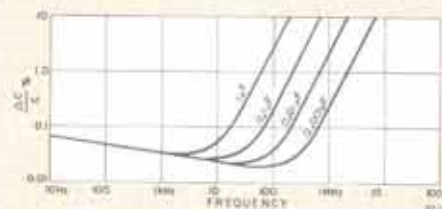

(Above) Change in capacitance as a function of frequency for typical 1409 Capacitors. The 1-kHz value on the plot should be used as a basis of reference in estimating frequency errors. (Below) Dissipation factor as a function of frequency.

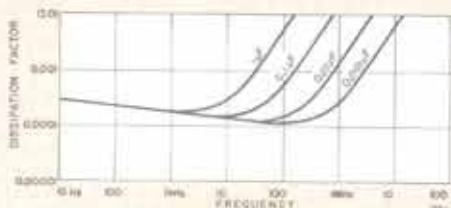

Description	Nominal Capacitance μF	Catalog Number
1409 Standard Capacitor		
1409-F	0.001	1409-9706
1409-L	0.01	1409-9712
1409-T	0.1	1409-9720
1409-Y	1.0	1409-9725

⊕ Federal stock numbers are listed before the Index.



1662 Resistance Limit Bridge

- Resistance range from 1 Ω to 111 M Ω
- 0.01% comparison precision
- GO, NO-GO indications
- up to 4 measurements per second
- deviation range from ± 0.01 to $\pm 30\%$
- four-terminal Kelvin connections

When resistor accuracy or precise resistor matching is crucial to circuit performance, the 1662 is the instrument to use for fast sorting, matching, and measuring.

A precision bridge with 0.01% accurate resistors, the 1662 has a built-in analog comparator and High/Low/Go indicator lights for production-speed test applications. The indicating meter and Limit controls are calibrated directly in percent resistance deviation with full-scale ranges from $\pm 0.3\%$ to $\pm 30\%$, permitting the selection and sorting of a variety of resistor types and qualities.

System Use Four-terminal connections for the unknown resistor permit measurement-at-a-distance; electrical outputs include analog of the deviation and high/low/go decision; both high and low limits are programmable. With these intrinsic features the 1662 can be the keystone of your production measuring system.

Laboratory Bridge The precise internal standards and built-in generator and detector make the 1662 an excellent and convenient laboratory bridge. Precise balancing is made especially easy by the indications of the High/Low lights. A special test fixture facilitates sure, split-second connection of one unknown resistor after another with true Kelvin connections to maintain the basic accuracy of the bridge.

— See *GR Experimenter* for November-December 1969.

SPECIFICATIONS

Resistance Range: 1 Ω to 111.1111 M Ω , controlled by 4-position multiplier switch and 7 in-line readout dials with decimal point.

Resistance Accuracy: $\pm(0.02\% + 2 \text{ m}\Omega + 0.02\% \text{ long-term})$; long-term factor can be removed by calibration.

Deviation: RANGE: ± 0.01 to $\pm 30\%$, controlled by 5-position range switch with full-scale ranges of 0.3, 1, 3, 10, and 30%. ACCURACY: $\pm 3\%$ of full-scale deviation (e.g., on 0.3% range, meter accuracy is $\pm 0.01\%$).

	Bridge Multiplier (R _x /R _s)			
	0.1	1	10	100
Range of Unknown	1 to 111 k Ω	10 to 1.11 M Ω	100 to 11.1 M Ω	10 k Ω to 111 M Ω
Voltage on Unknown*	0.11 V	0.2 V	1.1 V	10.1 V
Voltage on Standard	1.1 V	0.2 V	0.11 V	0.101 V
Resistance Resolution	0.01 Ω	0.1 Ω	1 Ω	10 Ω

* Varies with deviation from nominal; current is held constant. Power dissipated in unknown is $< 12 \text{ mW}$ from 1 Ω to 111 M Ω .

Displays: Meter indicates percent deviation. Limit lamps indicate High, Go, or Low condition. High and Low limits independently adjustable from 0 to 100% of deviation range with a direct accuracy of $\pm 2\%$ of full scale.

Speed: 1 measurement/s using meter indication, 4 meas/s using limit indications.

Interface: UNKNOWN CONNECTIONS: Cable (supplied), with banana plugs or alligator clips for 4-terminal connection. Test fixture (available) with quick-acting scissor 4-terminal contacts, best suited to axial-lead resistors. ANALOG OUTPUTS: Voltage proportional to meter deflection, $\pm 10 \text{ V}$ full scale with 0.003% resolution, is provided at 2 rear-panel sockets. Output impedances: $< 10 \Omega$ (drives 1782 Analog Limit Comparator) and $\approx 2 \text{ k}\Omega$ (drives a DVM, dc recorder, etc.). LIMIT OUTPUTS (digital): For High, Go, and Low conditions, corresponding lines switch from ≈ 13 to $\approx 0.2 \text{ V}$ (behind 10 k Ω). LIMIT PROGRAMMING: High and low limits programmable with dc analog drives of 0 to -10 V and 0 to $+10 \text{ V}$, respectively, by sources of $< 10 \Omega$ internal impedance. Rear connector.

Environment: Operating temperature, 10 to 40°C. Zero drift $< 2 \text{ ppm}/^\circ\text{C}$ from 10 to 40°C.

Supplied: 1662-2400 cable for connection to unknown or external-standard resistor, 7- and 9-pin connectors for interface connections, 5 alligator clips, and power cord.

Available: 1782 Analog Limit Comparator for comparisons to additional limits, 1662-P1 Test Fixture, for rapid 4-terminal connection of axial-lead components.

Power: 100 to 125 or 200 to 250 V, 50-60 Hz, 17 W.

Mechanical: Bench or rack models. DIMENSIONS (wxhxd): Bench, 19.75x8.69x14.8 in. (502x221x376 mm); rack, 19x7x14.8 in. (483x178x376 mm). WEIGHT: Bench, 28 lb (13 kg) net, 36 lb (16.5 kg) shipping; rack, 22 lb (10 kg) net, 28 lb (13 kg) shipping.

Description	Catalog Number
1662 Resistance Limit Bridge	
Bench Model	1662-9700
Rack Model	1662-9701
1662-P1 Test Fixture	1662-9601



1666 DC Resistance Bridge

New

- 0.01% accuracy, direct reading
- six-digit resolution
- 2-, 3-, or 4-terminal resistance or conductance
- 1 $\mu\Omega$ to 1 T Ω range (1 p Ω to 1 M Ω)

The GR 1666 combines the advantages of the Wheatstone and Kelvin bridges in a single instrument that will find application almost anywhere. Whether your requirement is for high accuracy, extremely-low or very-high resistance values, remote measurements, portability, or precise comparison, the 1666 will excel. It can even be set up for rapid sorting of resistors to tight tolerances.

Two-terminal, guarded, or Kelvin connections to the unknown resistor assure that the accuracy inherent in the 1666 can be realized at the point of measurement over the entire range of the bridge from 10^{-4} to 10^9 ohms. Internal adjustments on all ratio arms and bridge standards allow you to make calibration adjustments conveniently and rapidly, using a set of 1440 Standard Resistors.

The 1666 will make, with ease, such diverse measurements as winding resistance of transformers, switch-contact resistance, diode resistance (forward and reverse), leakage conductance of materials and devices, and the key parameters of resistance thermometers, standard resistors, and decades, by direct and comparison methods. The six lever switches and quick-response detector permit 0.01% balances to be made in less than 10 seconds — part-per-million balances in 20. Resistor sorting can be carried out even faster through use of the null meter as a deviation indicator; overload recovery of the detector is very rapid.

SPECIFICATIONS

Bridge Circuits: Kelvin and guarded Wheatstone in both resistance and conductance configurations.

Ranges: TOTAL MEASUREMENT RANGE, 1 $\mu\Omega$ to 1 T Ω . Resistance ranges, 1 $\mu\Omega$ to 1.1 M Ω in 7 ranges (1 $\mu\Omega$ is one

count); conductance ranges, 1 p Ω to 1.1 Ω in 7 ranges (1 p Ω is one count). RECOMMENDED RANGES: Wheatstone, 100 Ω to 1 T Ω ; Kelvin, 1 $\mu\Omega$ to 10 k Ω .

Resolution: Six digits or 1,111,110 counts.

Accuracy (limit or error) DIRECT READING (at 20 to 25°C and < 75% RH, within 6 months of calibration): For 0.1 to 1.0 full scale, accuracy is $\pm 0.01\% \pm 10$ ppm of full scale; 0.01 to 0.1 full scale, $\pm 0.02\% \pm 5$ ppm of full scale; below 0.01 full scale, $\pm 0.1\% \pm 2$ ppm of full scale. However, for 0 to 35°C and 85% RH and for 0 to 25°C and 95% RH, accuracy is generally 0.1%. TWO-YEAR ACCURACY: Add $\pm 0.01\%$ to above. COMPARISON ACCURACY: $\pm [2 + 0.001x$ (ppm difference)] ppm of full scale (decade values to 2 ppm where sensitivity is adequate and difference is small).

Sensitivity (with internal source): RESISTANCE: 2 $\mu\Omega$ at very low values; 10 ppm at 1 Ω ; 5 ppm at 10 Ω ; 1 ppm at 0.1, 1, 10, and 100 k Ω ; 5 ppm at 1 M Ω . CONDUCTANCE: 2 p Ω at very low values, 5 ppm at 1 $\mu\Omega$; 1 ppm at 10 and 100 $\mu\Omega$, 1 and 10 m Ω ; 5 ppm at 100 m Ω ; 10 ppm at 1 Ω . An external source can be used for even better sensitivity.

Sources: INTERNAL: 6 V (set of 4 D cells), 0.01 W max for resistance bridge. EXTERNAL: Up to 30 V dc, 0.5 W max.

Detector: SENSITIVITY: Meter deflection = 5 mm/ μ V. INPUT RESISTANCE: approx 20 k Ω . SHORT-CIRCUIT NOISE (slow position): Approx 0.1 μ V pk-pk. DRIFT: Typically 0.5 μ V/h. RESPONSE (slow/normal/fast, respectively): Low-level time constant, 4/2.5/0.7 s; high-level meter reversal, 1/0.5/0.3 s.

Guard (Wheatstone): No error with ≥ 5 M Ω to ground, either terminal.

Lead Error (Kelvin): No error with ≤ 0.1 Ω in any lead.

Supplied: Set of 4 leads with gold-plated copper alligator clips.

Available: 1440 Standard Resistors, for recalibration.

Power: Battery of 8 D cells (Burgess type 1200 or equivalent), i.e., 4 for internal bridge source and 4 for detector power.

Mechanical: Flip-Tilt case. DIMENSIONS: (w \times h \times d): 15x12x8 in. (381x305x203 mm). WEIGHT: 21 lb (10 kg) net.

Description	Catalog Number
1666 DC Resistance Bridge, portable	1666-9700
Replacement Battery (8 req'd)	8410-0200

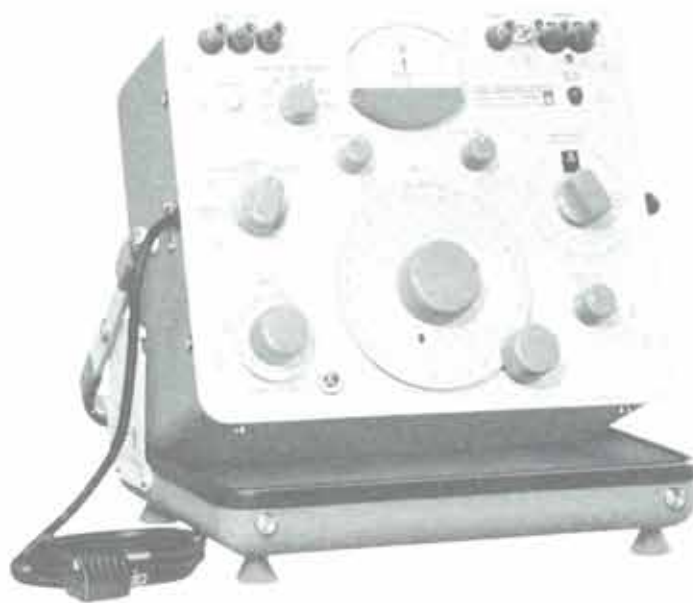

1644-A Megohm Bridge

- 10^1 to 10^{15} ohms
- 1% accuracy to 10^{12} ohms
- ΔR measurements to $\pm 0.2\%$
- seven test voltages
- self-checking internal standards

The 1644-A will measure:

- **Insulation Resistance** of cables, transformers, chokes, components, connectors, wiring, terminals, resistors, capacitors, relays, printed circuits, rotating machines, switches, circuit breakers, meters, strain gages, thermocouples, delay lines, slip rings, commutators, heaters, filters, lightning arresters, and other devices.
- **Resistance** of high-valued resistors, resistance films, diodes, transistors, and piezoelectric elements.
- **Voltage and Temperature Coefficients** of resistance.
- **Volume and Surface Resistivity** of solids, such as printed-board material, resins, plastics, potting and casting compounds, rubber, refractories, and semiconductors; of liquids, such as oils, plasticizers, and solvents; and of sheet materials, including plastics, recording tape, and varnished fabrics.

The circuit is a dc Wheatstone bridge with a high-impedance, high-sensitivity detector. Precision, wire-wound resistors are used for the fixed bridge arm and the lowest-valued decade-step arm. For medium values of the ratio arm, precision metal film resistors are used; for the highest values, carbon film resistors with trimmers. The balancing arm is a wire-wound variable resistor.

The guard terminal eliminates the effects of stray resistances to ground. For capacitor leakage resistance measurement, charging time is a fraction of a second.

SPECIFICATIONS

Resistance Range: 1 k Ω to 1000 T Ω (10^1 to 10^{15} Ω) in ten ranges.

Accuracy: 10^1 Ω to 10^9 Ω , $\pm 1\%$. After self-calibration: 10^{12} to 10^{15} Ω , $\pm 1\%$ *; 10^{11} Ω , $\pm 2\%$; 10^{10} Ω , $\pm 10\%$; 10^9 Ω , \pm one scale division.

$\Delta R\%$ Dial: $\pm 5\%$ range; accurate to $\pm 0.2\%$ or, for small changes, to $\pm 0.1\%$.

Test Voltage: Voltage accuracy is $\pm 3\% \pm 0.5$ V.

Fixed Voltages**	10	20	50	100	200	500	1000	V
Minimum Unknown R	1	3	7	20	50	150	500	k Ω
Minimum Test Voltage for 1% Resolution: for approx 1-mm meter deflection	Multiplier Setting		Max R.		Volts			
	100 G or less		10 ¹¹		10			
	100 G		10 ¹⁰		100			
	1 T		10 ⁹		200			

Short-Circuit Current: < 15 mA, 10-50 V; < 10 mA, 100-1000 V.

Power: 105 to 125 or 210 to 250 V, 50 to 400 Hz, 13 W.

Mechanical: Flip-Tilt case and rack mount. **DIMENSIONS** (w x h x d): Portable, 12.75x12.5x7.75 in. (324x318x197 mm); rack, 19x12.25x5 in. (483x312x127 mm). **WEIGHT:** 19 lb (9 kg) net, 31 lb (15 kg) shipping.

* At high voltages; 1% accuracy is obtainable at 10 V up to 10^{11} Ω .

** Any voltage between 10 and 1000 V may be obtained using an external resistor.

Description	Catalog Number
1644-A Megohm Bridge ±	
115-V Portable Model	1644-9701
115-V Rack Model	1644-9820
230-V Portable Model	1644-9711
230-V Rack Model	1644-9821

Patent Number 2,966,257

Ⓢ Federal stock numbers are listed before the Index.



1863 and 1864 Megohmmeters

GR 1863

- 5 test voltages: 50 to 500 V
- 50 k Ω to 20 T Ω ($2 \times 10^{13}\Omega$)
- economical, simple operation
- direct reading, safe, stable

GR 1864

- 200 test voltages: 10 to 1090 V
- 50 k Ω to 200 T Ω ($2 \times 10^{14}\Omega$)
- direct reading, safe, stable
- simple operation

If one of these GR megohmmeters doesn't exactly suit your high-resistance measurement needs, the other one should. Although the instruments are similar in appearance and accuracy, their operating ranges differ to match differing needs in the laboratory and production area:

Choice for production and inspection The 1863 Megohmmeter will measure resistance at any of five common test voltages up to 500 V, has fewer controls, and is the lower priced model. It is, therefore, the best selection when several test stations are to be equipped, when the operators are inexperienced, or when specifications call for standard insulation-testing voltages.

Choice for laboratory investigations The 1864 is the more flexible of the two instruments. The test voltage can be set to any value from 10 to 109 volts in 1-volt steps and to 1090 volts in 10-volt steps. Thus, the 1864 can be set to any common, or uncommon, test voltage for ceramic, mica or paper capacitors, or other devices. The reverse resistance of rectifiers can be readily measured; the low test voltages available are especially useful in measuring solid-state diodes. An additional range permits measurements up to 2×10^{14} ohms (200 T Ω).

Both instruments are easy to use with direct-reading meter indication and lighted range switch that shows the multiplier for each range and voltage. The maximum current possible at the terminals is limited to a safe 5 milli-

amperes and a panel light near the terminals warns when voltage is present. Stable power supplies and feedback voltmeter circuit minimize drift and time-wasting adjustments. Guard and ground terminals permit measurement of grounded or ungrounded two- or three-terminal resistors. The instruments are supplied for rack mounting or in a convenient, portable Flip-Tilt case that is a stand for the meter in use and protects it in transit and storage.

— See *GR Experimenter* for March-April 1969.

SPECIFICATIONS

Voltage and Resistance Ranges:

Voltage	R_{max} Full Scale	R_{min}^{\dagger} 10% of Scale	R_{min}^{\dagger} 2 1/2% of Scale	Useful Ranges
50, 100 V	50 k Ω	Type 1863		
200, 250, 500 V	500 k Ω	500 G Ω	2 T Ω	7
		5 T Ω	20 T Ω	7
		Type 1864		
10 to 50 V	50 k Ω	500 G Ω	2 T Ω *	7*
50 to 100 V	200 k Ω	5 T Ω	20 T Ω	8
100 to 500 V	500 k Ω	5 T Ω	20 T Ω *	7*
500 to 1090 V	5 M Ω	50 T Ω	200 T Ω	8

[†] Note: Meter deflects to the left, so 2 1/2% is near the right; however, the meter scale reads naturally, from left to right.

* Recommended limit.

Resistance Accuracy: ± 2 (meter reading + 1)% on lowest 5 ranges (min reading is 0.5). For 6th, 7th, 8th ranges, respectively, add $\pm 2\%$, $\pm 4\%$, \pm , for the 1863; $\pm 2\%$, $\pm 3\%$, $\pm 5\%$, for the 1864.

Voltage Accuracy (across unknown): $\pm 2\%$.

Short-Circuit Current: 5 mA approx.

Power: 100 to 125 or 200 to 250 V, 50 to 400 Hz, 13 W.

Supplied: Mounting hardware with rack models.

Mechanical: Flip-Tilt case and rack mount. **DIMENSIONS** (wxhxd): Portable, 6.63x10x6.75 in. (245x254x172 mm); rack, 19x7x4.63 in. (483x178x118 mm). **WEIGHT:** Portable, 9.5 lb (4.4 kg) net, 14 lb (7 kg) shipping; rack 11 lb (5 kg) net.

Description	Catalog Number
1863 Megohmmeter	
Portable Model \oplus	1863-9700
Rack Model	1863-9701
1864 Megohmmeter	
Portable Model	1864-9700
Rack Model	1864-9701

\oplus Federal stock numbers are listed before the Index.



1435 Programmable Decade Resistor

- 1.11 M Ω
- 0.02% basic accuracy
- completely programmable

The 1435 is a completely-programmable five-decade resistor (expandable to six or seven decades on special order) particularly adaptable to automatic test equipment for the control of load, time constant, gain, etc.

Each decade is controlled by a 12-position front-panel switch that displays 0 through X (10) and R (remote). This allows any decade or decades to be manually set while those remaining are remotely controlled. Another switch transfers total control of all the decades to the external control signal, regardless of the setting of the individual decade controls, and this transfer itself is externally programmable.

Four high-quality wire-wound resistors of low-temperature-coefficient Evanohm* wire are used in each decade. All are straight wound except the 10- Ω /step decade which is Ayrton-Perry wound to reduce inductance. Due to discontinuities that may exist when the settings are changed (manually or remotely), two logic lines are provided to short or open the decade-output terminals during the switching interval.

* Registered trademark of the Wilbur B. Driver Co.

SPECIFICATIONS

Range: 1,111,100 Ω total resistance; 10 Ω smallest step. Each decade can be individually controlled; manually by in-line-readout dials or remotely to digital techniques.

Programming: Control by negative true logic, 8-4-2-1 binary-coded decimal, at standard DTL or TTL levels (i.e., logic 0 = ground, logic 1 > +3.5 V) or closures to ground applied to rear-panel etched-board (36 pins.) **SWITCHING SPEED:** < 4 ms per change. Switches are mercury-wetted reed relays for low, stable, and repeatable zero resistance and are used for both manual and remote control.

Resistance Characteristics: **ACCURACY:** The difference between the resistances at any setting and at the zero setting is equal to the indicated value $\pm(0.02\% + 10 \text{ m}\Omega)$ for all decades except, for 10- Ω /step decade, the tolerance is $\pm(0.05\% + 10 \text{ m}\Omega)$; all at low currents and low or zero frequency. **ZERO RESISTANCE:** Typically 700 m Ω total (all decades set to zero). **TEMPERATURE COEFFICIENT:** $\pm(10 \text{ ppm} + 3 \text{ m}\Omega)/^\circ\text{C}$. **FREQUENCY DEPENDENCE:** At high resistance values, frequency characteristics depend mainly on capacitances and on the type of connections used (2- or 3-terminal,

grounded or guarded). At low resistance values, they depend mainly on the inductance. Calculations based on the values tabulated should give a good approximation to the series-resistance error. (Parameters are defined by diagram.)

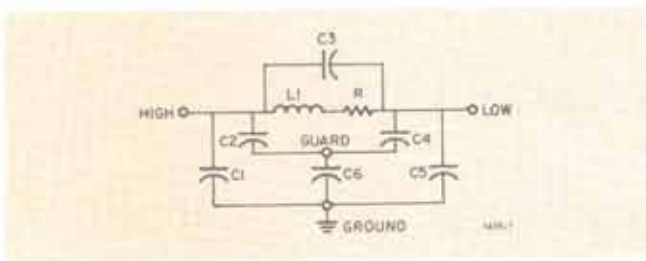

Parameter	Decade Resistance	
	R = 100 k Ω	R = 1 M Ω
C1	19 pF	11 pF
C2	76 pF	23 pF
C3	19 pF	16 pF
C4	247 pF	276 pF
C5	46 pF	51 pF
C6	1606 pF	1606 pF
L1	23 μH	23 μH

Signal Power Ratings: 0.125 W per step of the most-significant non-zero digit (1.25 W max) for specified accuracy; 0.25 W/step (2.5 W max) without damage. Each decade labeled with rated current. **GUARD VOLTAGE LIMIT:** 100 V max with respect to ground.

Terminals: 5 (High, Low, Ground, Guard, Guard) nickel-plated brass binding posts on rear panel; standard-spacing (0.75 in.).

Supplied: Power cord, Amphenol Type 225 board-edge connector, for programming input.

Power: 100 to 125 V or 200 to 250 V, 50 to 60 Hz, 7 W.

Mechanical: Bench or rack models. **DIMENSIONS (wxhxd):** Bench, 19.75x4.22x12.88 in. (502x107x327 mm); rack, 19x3.47x10.8 in. (483x88x275 mm). **WEIGHT:** Bench, 18 lb (8.5 kg) net, 23 lb (11 kg) shipping; rack, 13 lb (6 kg) net, 18 lb (8.5 kg) shipping.

Description	Catalog Number
1435 Programmable Decade Resistor	
Bench Model	1435-9700
Rack Model	1435-9701

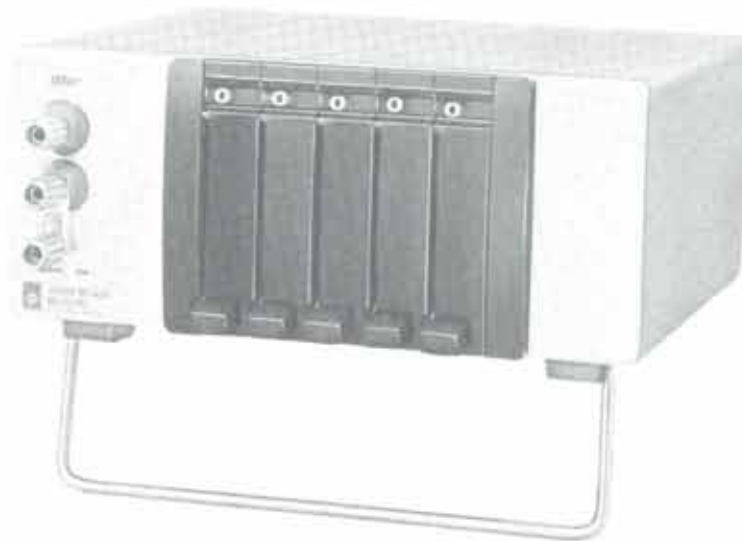

1436 Decade Resistor

- 111 k Ω or 1.11 M Ω
- 0.02% basic accuracy
- simple lever adjustment
- clear, easy-to-read display
- exceptionally small size

These decades feature small size, high accuracy, and convenient lever switches that provide digital readout and a means of easy and rapid adjustment.

Their accuracy at the higher values equals that of our most precise resistance decades. Solid silver-alloy is used

for the contacts to ensure long life and repeatable, low resistance. All resistors are precision, wire-wound units that use low-temperature-coefficient-alloy wire (Evanohm* for steps larger than 1 Ω). Resistors used for settings below one kilohm are Ayrton-Perry wound for low inductance. Six resistors are used per decade but they switch in such a manner that there are no discontinuities.

Specials Both models of the 1436 Decade Resistor are available without cabinets for custom installations. Other resistance values are available on request. Inquiries are invited.

* Registered trademark of the Wilbur B. Driver Co.



Rack model. Two can be combined for side-by-side mounting.

SPECIFICATIONS

Range:	Total Resistance	Smallest Step
1436-M	111,110 Ω	1 Ω
1436-P	1,111,100 Ω	10 Ω

Controlled by 5 lever switches with direct-reading digits. Solid silver-alloy contacts used for low, stable zero resistance.

Accuracy: The difference between the resistances at any setting and at the zero setting is equal to the indicated value $\pm(0.02\% + 5 \text{ m}\Omega)$ at low currents and at dc or low-freq ac.

Zero Resistance: $\approx 5 \text{ m}\Omega$ per decade, $\approx 25 \text{ m}\Omega$ total.

Temperature Coefficient: $\pm(10 \text{ ppm} + 100 \mu\Omega)/^\circ\text{C}$ at room temperature.

Maximum Power: 0.1 W per step (1 W max total) without accuracy change, 0.25 W per step (2.5 W max total) without damage.

Terminals: Three (HIGH, LOW, GROUND) gold-plated-copper binding posts with standard $\frac{3}{4}$ -in. spacing on front panel; lug connections on rear.

Mechanical: Convertible bench cabinet. DIMENSIONS (w x h x d): Bench, 8.5x3.88x8.31 in. (216x99x212 mm); rack, 19x3.5x7.25 in. (483x89x185 mm). WEIGHT: Bench, 5 lb (2.3 kg) net, 6 lb (2.8 kg) shipping; rack, 7.5 lb (3.4 kg) net, 9 lb (4.1 kg) shipping.

Description	Catalog Number
1436-M Decade Resistor, 111,110 Ω	
Bench Model	1436-9700
Rack Model	1436-9701
1436-P Decade Resistor, 1,111,100 Ω	
Bench Model	1436-9702
Rack Model	1436-9703

1433 Decade Resistor

- $\pm 0.01\%$ accuracy
- good frequency characteristics
- low temperature coefficient
- excellent stability
- low zero resistance

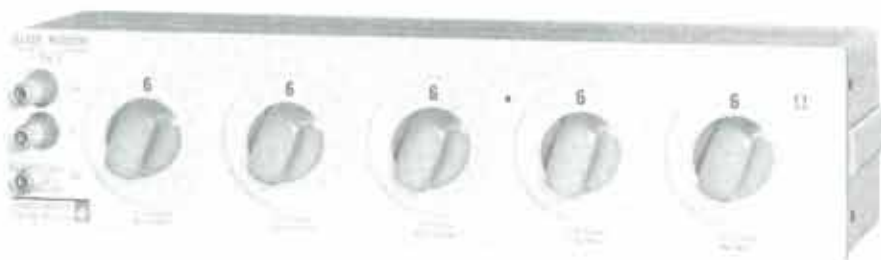

The 1433 Decade Resistors are primarily intended for precision measurement applications where their excellent accuracy, stability, and low zero resistance are important. They are convenient resistance standards for checking the accuracy of resistance-measuring devices and are used as components in dc and audio-frequency impedance bridges. Many of the models can be used up into the radio-frequency range. Although they are quite satisfactory as substitution boxes for optimizing electronic circuitry, the less expensive 1434 Decade Resistors are recommended for such less exacting applications.

Each 1433 Decade Resistor is an assembly of GR 510 Decade-Resistance Units in a single cabinet. Mechanical as well as electrical shielding of the units and switch contacts is provided by the attractive aluminum cabinet and panel. The resistance elements have no electrical connection to the cabinet and panel, for which a separate shield terminal is provided.

The individual decades (510 Decade-Resistance Units) are available for applications requiring only one decade or as components to be built into experimental equipment, production test equipment, or commercial instruments.

SPECIFICATIONS

Accuracy: The specified tolerances apply for low-current measurement at dc or low-frequency ac (see below).

Over-all Accuracy: The difference between the resistances at any setting and at the zero setting is equal to the indicated value $\pm(0.01\% + 2 \text{ m}\Omega)$.

Incremental Accuracy: See table. This is the accuracy of the change in resistance between any two settings on the same dial.

Max Current: The max current for each decade is given in the table below and also appears on the panel of each decade box and on the dial plate of each decade resistance unit.

Frequency Characteristic: The accompanying plot shows the max percentage change in effective series resistance, as a function of frequency for the individual decade units. For low-resistance decades the error is due almost entirely to skin effect and is independent of switch setting. For the high-resistance units the error is due almost entirely to the shunt capacitance and its losses and is approx proportional to the square of the resistance setting.

The high-resistance decades (510-E, -F, -G, and -H) are very commonly used as parallel resistance elements in resonant circuits, in which the shunt capacitance of the decades becomes part of the tuning capacitance. The parallel resistance changes by only a fraction (between a tenth and a hundredth)

of the series-resistance change, depending on frequency and the insulating material in the switch.

Characteristics of the 1433's are similar to those of the individual 510's modified by the increased series inductance, L_s , and shunt capacitance, C , due to the wiring and the presence of more than one decade in the assembly. At total resistance settings of approx 1000 ohms or less, the frequency characteristics of any of these decade resistors are substantially the same as those shown for the 510's. At higher settings, shunt capacitance becomes the controlling factor, and the effective value of this capacitance depends upon the settings of the individual decades.

Typical Values of R_s , L_s , and C for the Decade Resistors:

Zero Resistance (R_s): 0.001 Ω per dial at dc; 0.04 Ω per dial at 1 MHz; proportional to square root of frequency at all frequencies above 100 kHz.

Zero Inductance (L_s): 0.1 μH per dial $\pm 0.2 \mu\text{H}$.

Effective Shunt Capacitance (C): This value is determined largely by the highest decade in use. With the low terminal connected to the shield, a value of 15 to 10 pF per decade may be assumed, counting decades down from the highest. Thus, if the third decade from the top is the highest resistance decade in circuit (i.e., not set at zero), the shunting terminal capacitance is 45 to 30 pF. If the highest decade in the assembly is in use, the effective capacitance is 15 to 10 pF, regardless of the settings of the lower-resistance decades.

Temperature Coefficient of Resistance: Less than ± 10 ppm per degree C for values above 100 Ω and ± 20 ppm per degree C for 100 Ω and below, at room temperatures. For the 1433's

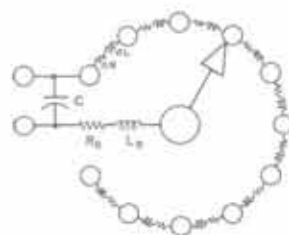

Equivalent circuit of a resistance decade, showing residual impedances.

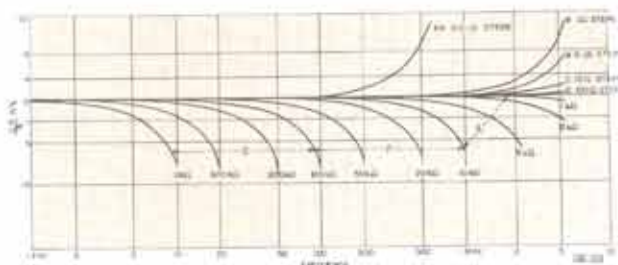

Max percentage change in series resistance as a function of frequency.

the box wiring will increase the over-all temperature coefficient of the 0.1- and 0.01- Ω decades.

Switches: Quadruple-leaf brushes bear on lubricated contact studs of $\frac{3}{16}$ -in. diameter in such a manner as to avoid cutting but yet give a good wiping action. A ball-on-cam detent is provided. There are eleven contact points (0 to 10 inclusive). The switch resistance is less than 0.0005 Ω . The effective capacitance is of the order of 5 pF, with a dissipation factor of 0.06 at 1 kHz for the standard cellulose-filled molded phenolic switch form and 0.01 for the mica-filled phenolic form used in the 510-G and 510-H units.

Max Voltage to Case: 2000 V pk.

Terminals: Low-thermal-emf jack-top binding posts on standard $\frac{3}{16}$ -in. spacing; also provisions for rear-panel connections. Shield terminal is provided.

Mounting: Lab-bench cabinet, rack models include mounting hardware.

Dimensions and Weights: in. (mm), lb (kg):

	4-dial U, K, J, L, Q	5-dial T, N, M, P, Y	6-dial W, X, B, Z	7-dial F, G, H
Width*	12.3 (312)	14.8 (375)	17.3 (439)	
Height	3.5 (89)		5.3 (135)	
Depth	5 in. over-all, 4 in. behind panel (127, 102)			
Net Wt**	4.8 (2.2)	5.8 (2.7)	7 (3.2)	8.8 (4.0)
Ship. Wt**	5.5 (2.5)	6.5 (3.0)	8.5 (3.9)	10.3 (4.7)

* Data given for bench models. All rack models same except 19 in. (483 mm) wide.

** Add approx 1 lb (0.5 kg) for rack-mount hardware.

Type	Total Ohms	Ohms per Step	No. of Dials	Type 510 Decades Used	Catalog Number	
					Bench	Rack
1433-U	111.1	0.01	4	AA, A, B, C	1433-9700	1433-9701
1433-K	1111	0.1	4	A, B, C, D	1433-9702	1433-9703
1433-J	11,110	1	4	B, C, D, E	1433-9704	1433-9705
1433-L	111,100	10	4	C, D, E, F	1433-9706	1433-9707
1433-Q	1,111,000	100	4	D, E, F, G	1433-9708	1433-9709
1433-T	1111.1	0.01	5	AA, A, B, C, D	1433-9710	1433-9711
1433-N	11,111	0.1	5	A, B, C, D, E	1433-9712	1433-9713
1433-M	111,110	1	5	B, C, D, E, F	1433-9714	1433-9715
1433-P	1,111,100	10	5	C, D, E, F, G	1433-9716	1433-9717
1433-Y	11,111,000	100	5	D, E, F, G, H	1433-9718	1433-9719
1433-W	11,111.1	0.01	6	AA, A, B, C, D, E	1433-9720	1433-9721
1433-X	111,111	0.1	6	A, B, C, D, E, F	1433-9722	1433-9723
1433-B	1,111,110	1	6	B, C, D, E, F, G	1433-9724	1433-9725
1433-Z	11,111,100	10	6	C, D, E, F, G, H	1433-9726	1433-9728
1433-F	111,111.1	0.01	7	AA, A, B, C, D, E, F	1433-9729	1433-9730
1433-G	1,111,111	0.1	7	A, B, C, D, E, F, G	1433-9731	1433-9732
1433-H	11,111,110	1	7	B, C, D, E, F, G, H	1433-9733	1433-9734

510 Decade-Resistance Unit

The 510 Decade Units that essentially make up the 1433 are also available separately for applications requiring a single decade or as components for experimental setups, production test equipment, or commercial instruments.

Each Decade-Resistance Unit is enclosed in an aluminum shield; a knob and etched-metal dial plate are supplied. Each decade has ten resistors in series; the contacts in the lower-valued decades have a silver overlay to ensure stability of resistance, and all the decades have a silver contact on the zero setting to give low and constant zero resistance. Winding methods are chosen to reduce the effects of residual reactances.

510-B mounted on a small panel.



SPECIFICATIONS

Electrical: See table.

Terminals: Soldering lugs.

Supplied: Dial plate, knob, template, and mounting screws.

Mechanical: Panel mounting, in shield can; DIMENSIONS: Dia. 3.06 in. (78 mm), depth 3.31 in. (85 mm) behind panel, WEIGHT: 11 oz (312 g) net.

Type	Total Resistance Ohms	Resistance Per Step (AR) Ohms	Accuracy of Resistance Increments	Max Current 40° C Rise	Power Per Step Watts	AL μ H	C** pF	L _s μ H	Catalog Number
510-AA	0.1	0.01	$\pm 2\%$	4 A	0.16	0.01	7.7-4.5	0.023	0510-9806
510-A	1	0.1	$\pm 0.4\%$	1.6 A	0.25	0.014	7.7-4.5	0.023	0510-9701
510-B	10	1	$\pm 0.1\%$	800 mA	0.6	0.056	7.7-4.5	0.023	0510-9702
510-C	100	10	$\pm 0.04\%$	250 mA	0.6	0.11	7.7-4.5	0.023	0510-9703
510-D	1000	100	$\pm 0.01\%$	80 mA	0.6	5	7.7-4.5	0.023	0510-9704
510-E	10,000	1000	$\pm 0.01\%$	23 mA	0.5	13	7.7-4.5	0.023	0510-9705
510-F	100,000	10,000	$\pm 0.01\%$	7 mA	0.5	70	7.7-4.5	0.023	0510-9706
510-G	1,000,000	100,000	$\pm 0.01\%$	2.3 mA	0.5	—	7.7-4.5	0.023	0510-9707
510-H	10,000,000	1,000,000	$\pm 0.01\%$	0.7* mA	0.5	—	7.5-4.5	0.023	0510-9708
510-P4	Switch only	(Black Phenolic Frame)							0510-9604
510-P4L	Switch only	(Low-Loss Phenolic Frame)							0510-9511

* Or a max of 4000 V, pk.

** The larger capacitance occurs at the highest setting of the decade. The values given are for units without the shield cans in place. With the shield cans in place, the shunt capacitance is from 0 to 20 pF greater than indicated here, depending on whether the shield is tied to the switch or to the zero end of the decade.

⊕ Federal stock numbers are listed before the index.

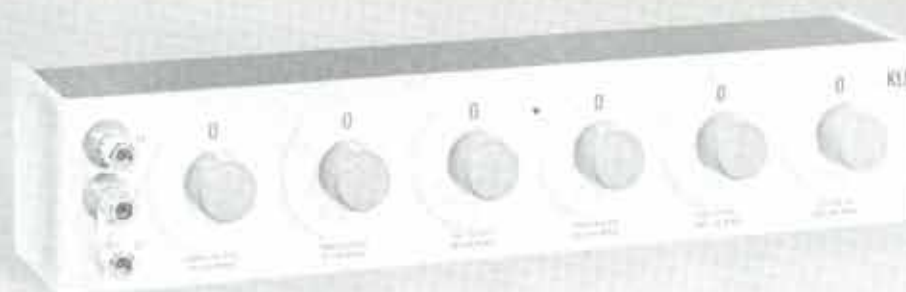

1434 Decade Resistor

- $\pm 0.02\%$ accuracy
- 5-, 6-, or 7-dial settability
- excellent stability, low cost

These laboratory-quality, budget-priced decade boxes are designed for maximum usefulness and economy in laboratory measurement, testing, and development work. Their accuracy is adequate for all but the most exacting applications. Their small size and clear readout should be particularly useful in experimental setups using small, modern components.

The 1434-M, -N, and -P contain five step decades of resistance in a small cabinet. The 1434-B and -X, 6-dial boxes, permit small as well as large values of resistance to be set with 3- or 4-place resolution and accuracy. The 1434-QC, a "best buy," has four step decades plus a rheostat to provide 1-ohm resolution in a 1-megohm box.

The larger, seven-decade, 1434-G box is easily converted into a 3½-inch relay-rack unit by the addition of angle brackets and dress strips, which are furnished. This box has lug terminals available at the rear, as well as at panel binding posts.

DESCRIPTION

High-quality, wire-wound resistors are used in these decades. The low price is made possible by the use of only six resistors per decade instead of ten. These are combined by switching in such a way that there are no discontinuities; that is, the resistance increases stepwise just as though ten resistors were used. The switches have solid-silver-alloy contacts for low resistance and long life.

Resistors are of low-temperature-coefficient Evanohm* wire, except the 1-ohm/step and 0.1-ohm/step decades which use wire and ribbon (respectively) of another low-temperature coefficient alloy. The resistors of the 100-, 10-, and 1-ohm/step decades are Ayrton-Perry wound to minimize inductance.

* Registered trademark of the Wilbur B. Driver Company.

SPECIFICATIONS

Accuracy: Tolerances apply at low currents and at dc or low-frequency ac.

Over-all: The difference between the resistances at any setting and at the zero setting is equal to the indicated value $\pm (0.02\% + 5 \text{ m}\Omega)$, except for the 1434-QC, which may have an additional error of $\pm 1 \Omega$ when the rheostat is used.

Incremental: See table. This is the accuracy of the change in resistance between any two settings of the same dial.

Zero Resistance: Approx 3 m Ω per dial at low frequencies; except for the 1434-QC, approx 30 m Ω .

Max Current: See table; these values also appear on the panel of each decade box. When this max current is passed through a decade, the temporary change in value will be less than the accuracy specification. Currents appreciably higher than this will cause permanent damage.

Total Resistance of Decade	Resistance Per Step	Incremental Accuracy*	Max Current
1 Ω	0.1 Ω	$\pm 3.0\%$	1 A
10 Ω	1.0 Ω	$\pm 0.3\%$	0.3 A
100 Ω	10 Ω	$\pm 0.05\%$	160 mA
1 k Ω	100 Ω	$\pm 0.02\%$	50 mA
10 k Ω	1 k Ω	$\pm 0.02\%$	16 mA
100 k Ω	10 k Ω	$\pm 0.02\%$	5 mA
1 M Ω	100 k Ω	$\pm 0.02\%$	1.6 mA
100- Ω Rheostat**	1 Ω /div	$\pm 1 \Omega$	200 mA

* At low currents and low frequencies.

** Used in 1434-QC.

Temperature Coefficient: ≤ 10 ppm/ $^{\circ}\text{C}$ at room temperature, except for the low-valued units where the $\pm 0.4\%/^{\circ}\text{C}$ temperature coefficient of the zero resistance must be added.

Frequency Characteristics: Generally similar to those of the 1433 Decades.

Switches: Multiple wiper, solid-silver-alloy switches are used to obtain low and stable zero resistance.

Terminals: Jack-top binding posts on standard ¾-in. spacing. A shield terminal is also provided. The 1434-G has lug connections accessible from the rear.

Mounting: All types except the 1434-G are in small cabinets for bench use. The 1434-G is also designed for bench use but, with the addition of mounting hardware, becomes 3½-in. high, 19-in. relay-rack unit.

Mechanical Data:

Models	Width		Height		Depth		Net Weight		Shipping Weight	
	in.	mm	in.	mm	in.	mm	lb	kg	lb	kg
M, N, P, QC	11½	300	2¾	70	4½	108	3	1.4	4	1.9
B, X	13¾	350	2¾	70	4½	108	3½	1.5	4	1.9
G (bench)	17¾	440	3½	89	5	127	6	2.8	7	3.2
G (rack)	19	483	3½	89	3½	89	6	2.8	7	3.2

Description	Total Resistance(Ω)	Resistance Per Step	Number of Decades	Catalog Number
Decade Resistor				
1434-N	11,111	0.1 Ω	5	1434-9714
1434-M	111,110	1.0 Ω	5	1434-9713
1434-P	1,111,100	10 Ω	5	1434-9716
1434-QC	1,111,105	1 Ω /div	4 + rheo	1434-9576
1434-B	1,111,110	1.0 Ω	6	1434-9702
1434-X	111,111	0.1 Ω	6	1434-9724
1434-G	1,111,111	0.1 Ω	7	1434-9707

* Federal stock numbers are listed before the Index.

1444-A 10-k Ω standard with temperature sensor, shown with carrying case.

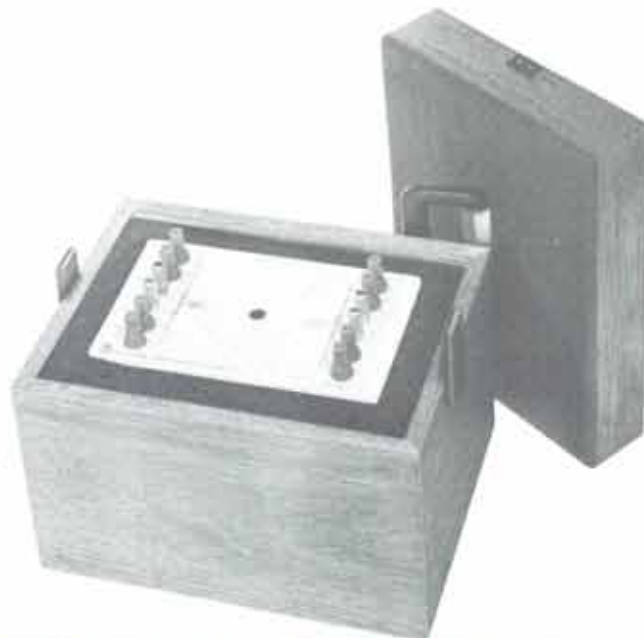

1444-A Reference Resistance Standard

- 10 k Ω
- 3 ppm accuracy
- 1 ppm-per-year stability
- extremely low temperature coefficient
- guarded 4-terminal connections

The high stability and extremely low temperature coefficient of the 1444 Reference Resistance Standard well suits it for use in standards laboratories that lack a closely controlled environment. Also, because this standard is practically unaffected by atmospheric pressure changes or mechanical and thermal shock, it is valuable as a portable standard for intercomparisons.

The resistor used as a standard consists of two large 5-kilohm resistor elements wound on metal substrates that have the same thermal expansion coefficient as the wire to avoid stresses caused by temperature changes. The Evanohm* wire used is bare to eliminate any me-

chanical constraints caused by changes in the hardness of the normally used lacquer coating. After winding, the resistor elements are high-heat treated to ensure the utmost stability. The resistor is then placed in a heavy stainless-steel container, totally evacuated, back-filled with extra-dry nitrogen, and hermetically sealed. The nitrogen avoids possible oxidation effects that might otherwise be caused by the minute amounts of humidity present in even the best oil. All leads are brought out through glass-to-metal seals, a thermometer well is provided, and a temperature correction chart is supplied.

Sensor The 1444-A contains an additional resistor, a 10-k Ω temperature sensor with a temperature coefficient of 1,000 ppm, which is mounted in close thermal contact with the standard resistor elements. The temperature of the standard can then be measured with a high degree of accuracy by measurement of the resistance of the sensor. The container of the 1444-A is shock mounted in an outer container and then placed in a foam-rubber-lined carrying case.

* Registered trademark of the Wilbur B. Driver Company.

SPECIFICATIONS

Nominal value: 10 k Ω .

Accuracy: \approx 3 ppm, compared with an uncertainty of 0.1 ppm to a standard measured by NBS with a stated uncertainty of 1 ppm.

Stability: 1 ppm, 1st year; 0.5 ppm/yr, thereafter.

Environment: TEMPERATURE COEFFICIENT, individual temperature-correction chart for 18 to 28°C supplied. At 23°C, $\alpha \leq \pm 0.1$ ppm/°C; $\beta \leq -0.05$ ppm/°C² between 18 and 28°C. Value changes $\leq \pm 0.1$ ppm with normal atmospheric and humidity variations. THERMAL TIME CONSTANT, 1 hour minimum.

Electrical: POWER, 0.1 W max. VOLTAGE, 500 V max to case. THERMAL EMF, $\leq \pm 0.1$ μ V under normal test conditions. CURRENT REVERSAL, value changes $\leq \pm 0.1$ ppm. DIELECTRIC SOAKING EFFECT, value stabilizes within 5 s to ≈ 0.1 ppm of

final value. INSULATION RESISTANCE, $>10^4$ Ω from resistor terminals to ground.

Terminals: Gold-plated copper binding posts, 4 each for standard, sensor, and ground.

General: Thermometer well and temperature sensor provided. Extra-dry-nitrogen filled, hermetically sealed in heavy stainless-steel case. Supplied with an outer container and foam-rubber-lined carrying case.

Mechanical: (With carrying case). DIMENSIONS (wxhxd); 11.5x10.63x8.5 in. (293x270x216 mm). WEIGHT: 12 lb (6 kg) net, 17 lb (8 kg) shipping.

Description	Catalog Number
1444-A Reference Resistance Standard, 10 k Ω , with sensor	1444-9700



1440 Standard Resistor

- 0.01Ω to 1 MΩ
- accuracy ±0.01%
- stability ±10 ppm per year
- low thermal emf to copper

These extremely stable resistors are intended for use as laboratory or production standards for calibrating resistance bridges and for substitution measurements.

Units of 0.01 and 0.1 Ω are made of sheet metal with a low temperature coefficient of resistance, punched in a meander pattern to reduce inductance. Units of 1 Ω and above are card-type wire-wound resistors, carefully

wound and adjusted. Low-temperature-coefficient wire is used for units of 1 Ω and 10 Ω; Evanohm* wire is used for units above 10 Ω. All units are heat cycled to reduce strains and are repeatedly checked to eliminate any that show abnormal behavior. They are encased in sealed, oil-filled, diallylphthalate boxes to promote long-term stability and to provide mechanical protection.

The 1440 resistors have low-thermal-emf binding posts and removable banana plugs to provide the four terminals necessary for accurate measurements at low values of resistance. A label on the reverse side lists initial calibration and date, serial number, and space for future calibration data.

* Registered trademark of the Wilbur B. Driver Company.

SPECIFICATIONS

Accuracy: See table. Measurements on the low-value units should be made with a four-terminal connection. All measurements at 23°C.

Calibration Accuracy: Resistors are calibrated by comparison, to a precision of ±20 ppm, with working standards whose absolute values are known typically to ±10 ppm as determined and measured in terms of reference standards periodically measured by the National Bureau of Standards. The measured deviation in % from nominal value, at 23°C and 0.01 watt, is entered on the label on the reverse side of the resistor.

Stability: Typically ±10 ppm per year (1 MΩ to 1 Ω).

Temperature Coefficient (Max): See table.

Power Rating: 1 W. The corresponding current is indicated on the resistor and in the table below. This dissipation will cause

a temperature rise of approx 25°C and a resulting temporary resistance change due to the temperature. If this rating is exceeded, permanent changes may result.

Residual Impedances: Approx shunt capacitance (2-terminal measurement), 2.5 pF; less for 3-terminal measurement. Typical series inductance, see table.

Approx Frequency Characteristics: See table.

Terminals: Gold-plated jack-top copper binding posts (¼-in. spacing) with banana plugs that are removable and can be replaced by 6-32 screws for installation of soldering lugs.

Dimensions (less terminals): 2.25x2.47x0.34 in. (58x63x9 mm).

Net Weight (approx): 2 oz (57 g).

Resistance*	Accuracy	Max Current	Inductance Typical	Approx Frequency for 0.1% Resistance Change		Temperature Coefficient	Catalog Number
				Series R	Parallel R		
0.01 Ω	±0.10%	5 A	0.1 μH	3 kHz	1 kHz	±20 ppm	1440-9671
0.1 Ω	±0.05%	2 A	0.1 μH	20 kHz	10 kHz	+30 ppm	1440-9681
1 Ω	±0.02%	1.0 A	0.12 μH	300 kHz	30 kHz	±20 ppm	1440-9601
10 Ω	±0.01%	310 mA	0.13 μH	1 MHz	300 kHz	±20 ppm	1440-9611
100 Ω	±0.01%	100 mA	5. μH	3 MHz	1 MHz	±10 ppm	1440-9621
1 kΩ	±0.01%	30 mA	2.5 μH	2 MHz	1 MHz	±10 ppm	1440-9631
10 kΩ	±0.01%	10 mA		200 kHz	1 MHz	±10 ppm	1440-9641
100 kΩ	±0.01%	3 mA		20 kHz	100 kHz	±10 ppm	1440-9651
1 MΩ	±0.01%	1 mA		2 kHz	10 kHz	±10 ppm	1440-9661

* Other special values, available on request.

* Federal stock numbers are listed before the Index.



1442 Coaxial Resistance Standard

- $\pm 0.05\%$ -per-year stability
- one- or two-port
- GR900® connectors

The General Radio 1442's are designed to serve as standards of resistance and, used with GR coaxial capacitance standards, as standards of dissipation factor. In either role, they can be used to calibrate impedance bridges at frequencies as high as 100 MHz.

—See **GR Experimenter** for March-April 1959.

SPECIFICATIONS

Initial DC Accuracy: $\pm 0.1\%$ except $\pm 0.25\%$ for 1442-D.

Stability: $\pm 0.05\%$ per year.

Dissipation: 1 W max.

Capacitance (inner to outer conductor): 5 pF, typical.

Inductance: 9 nH, typical.

Temperature Coefficient of Resistance: ± 50 ppm/°C, except ± 100 ppm/°C for 1442-D.

Available: 900-WN SHORT CIRCUIT, 900-Q9 ADAPTOR for

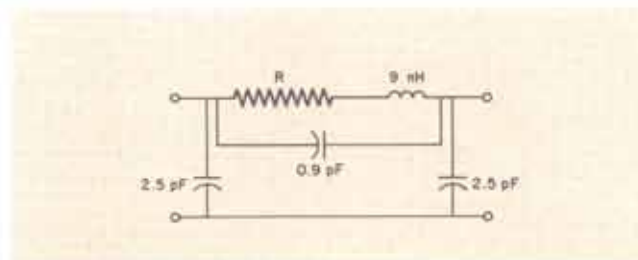

Equivalent circuit of a 1442 resistor shown with approximate values of capacitance and inductance.

connecting standard to $\frac{1}{8}$ -inch x 28 threaded stud (GR 938 binding post) or tapped hole.

Dimensions (diameter x length): 1.19x2.38 in. (31x61 mm).

Description	Resistance	Catalog Number
Coaxial Resistance Standard		
1442-D	1.0 Ω	1442-9703
1442-G	10 Ω	1442-9706
1442-K	100 Ω	1442-9709
1442-N	1000 Ω	1442-9712

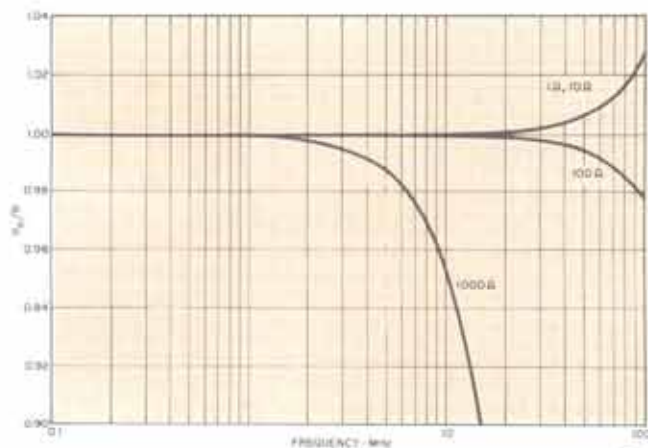

Typical ratios of effective ac series resistance to dc resistance, using a GR 900-WN connected to one end of the 1442 resistor.

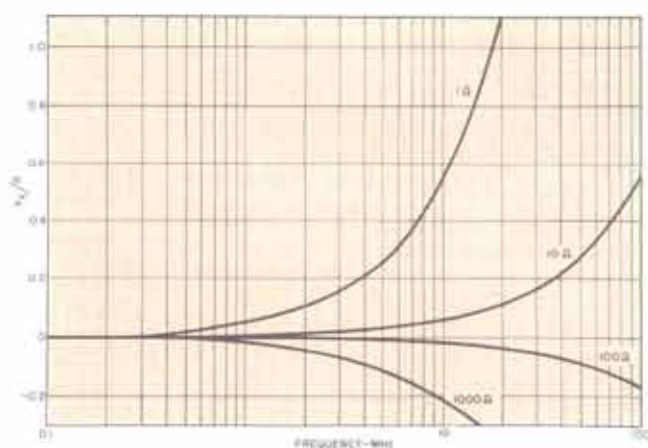

Typical ratios of effective ac series reactance to dc resistance, using a GR 900-WN connected to one end of the 1442 resistor.

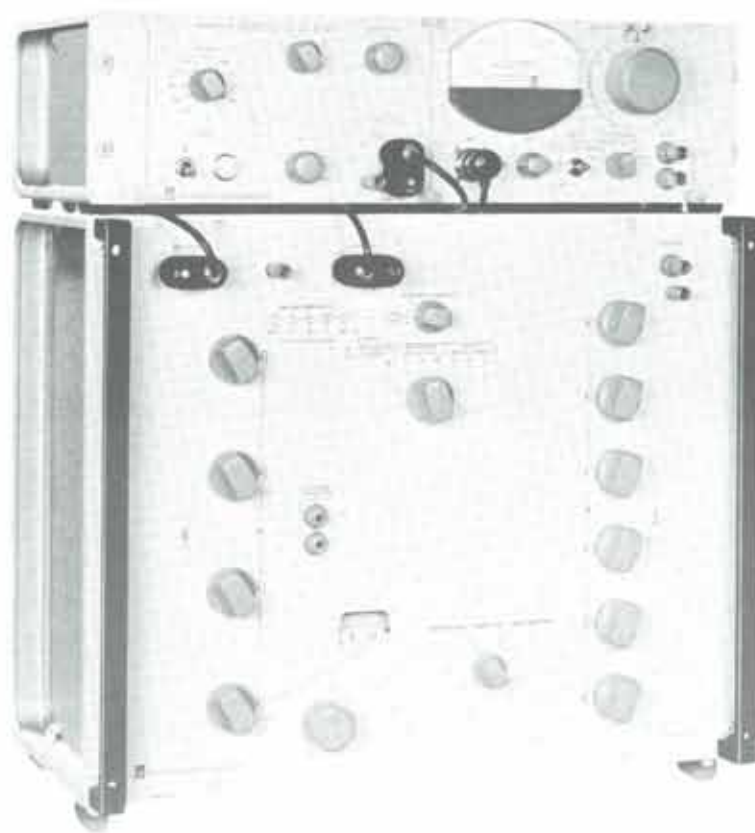

1660-A Precision Inductance-Measuring Assembly includes 1632-A Inductance Bridge, 1311-A Oscillator, 1232-A Tuned Amplifier and Null Detector.

1660-A Precision Inductance-Measuring Assembly

- 0.1 nH to 1.1 kH, $\pm 0.1\%$ accuracy
- comparison to 6-figure resolution
- series or parallel L, no sliding balance
- in-line readout, automatic decimal point

The 1660-A assembly contains the 1632-A Inductance Bridge with appropriate oscillator and null detector, assembled, interconnected, and measurement-ready. The inductance bridge can be supplied alone so you can make your own assembly with a suitable oscillator and detector, particularly if measurements are required at frequencies other than the 11 provided by the oscillator in this assembly.

The 1632 Bridge measures series or parallel components of two-terminal grounded inductors, at audio frequencies. Its high accuracy suits the most demanding absolute measurements, while its six-place resolution

enables you to make high-precision intercomparisons of inductance standards by substitution methods.

The Owen bridge circuit uses for the standard of reactance a capacitor that, owing to its very low residual impedances, exhibits a negligible change in its effective capacitance over the audio frequency range. The Owen circuit also makes possible the use of the high accuracy of decade resistors for the inductance balance.

Inductance is indicated by the setting of a six-decade control, conductance by the setting of four decades and a continuously variable control. The dials, which show only the pertinent digit of each decade, indicate inductance directly. Resistance, either series or parallel, is the reciprocal of the conductance setting. An eight-position multiplier automatically indicates both the decimal point and the units of measurement.

For maximum accuracy in the measurement of both large and small values of inductance, the residual impedances associated with the unknown terminals have been minimized.

SPECIFICATIONS

Inductance: RANGE, 0.1 nH to 1111 H. ACCURACY, $\pm 0.1\%$, direct reading, except at extremes of inductance, frequency, and Q ranges; $\pm(1\% + 1 \text{ nH})$ on lowest range (0.1 nH to 111 μH). If Q is less than 1, accuracy is reduced to: $(+0.05 \pm Q_x) / Q_x$. Values of Q_x at 1 kHz are:

Range	a, b, c	d- Low Z	e- High Z e- Low Z	f- High Z f- Low Z	g- High Z g	h
R_x	1 Ω	10 Ω	100 Ω	1 k Ω	10 k Ω	100 k Ω
Q_x	$\pm 0.03\%$	$\pm 0.005\%$	$\pm 0.002\%$	$\pm 0.002\%$	$\pm 0.02\%$	$\pm 0.1\%$

Above 1 kHz, multiply Q_x values by f_{min} . Additional error of 0.001 (f_{min})% on lowest L range and of 0.04 (f_{min})% on highest range. Two nearly even inductors can be intercompared to a precision of 10 ppm or better. Bridge adds about 1 pF to capacitance across inductor. Bridge reading with unknown terminals shorted is about 0.1 μH .

Conductance: RANGE: 0.1 nS to 1111 S. ACCURACY: $\pm 1\%$, direct reading, reduced at extremes of inductance, conductance, frequency, and Q ranges. C_x capacitor decades are adjusted within $\pm 1\% + 5 \text{ pF}$. PREDICTABLE ERRORS: If Q is greater than 10, the error in either series resistance or parallel conductance is increased to $Q_x (+0.05 \pm Q_x)\%$. (See above table for values of Q_x at 1 kHz, and, above 1 kHz, multiply Q_x values by f_{min} .) When bridge reads series conductance, there is an additional error in series resistance of 0.15 $Q_x\%$ at 1 kHz, when the L decades are set at 1/10 full scale ($R_x = 10 \text{ k}\Omega$); this error is proportional to frequency (with constant Q_x) and approximately proportional to resistance (R_x) of L decades.

Maximum Measurable Q: Series connection, proportional to frequency, 60 at 100 Hz; parallel connection, 80 at 100 Hz and R_x of 100 k Ω , inversely proportional to frequency and to R_x .

Frequency Range: Nominally 1 kHz and lower. Usable to 10 kHz with accuracy considerations discussed above. Oscillator in 1660 assembly generates 50, 60, 100, 120, 200, 400, and 500 Hz, 1, 2, 5, and 10 kHz only.

Generator: Type 1311-A Oscillator supplied in 1660 assembly. Type 1310-A is recommended for continuous frequency coverage. Max safe bridge voltage is 1 V on low-L ranges to 100 V on high ranges; values engraved on panel.

Detector: Type 1232-A Tuned Amplifier and Null Detector supplied in 1660 assembly and recommended for general use.

Supplied: 274-NL Shielded Patch Cord and 874-R34 Patch Cord for generator and detector connection; 1632-P1 Transformer to match low bridge input impedances to 600- Ω generator.

Power: 105 to 125 or 210 to 250 V, 50 to 400 Hz, 22 W for 1311-A Oscillator. Null Detector operates from internal battery supply. Bridge requires no power.

Mechanical: Bench cabinet assembly. DIMENSIONS (wxhxd): 19x23x10.5 in. (483x584x267 mm). WEIGHT: 62 lb (29 kg) net, 92 lb (42 kg) shipping.

Description	Catalog Number
Precision Inductance-Measuring Assembly	
1660-A, 115 V	1660-9701
1660-A, 230 V	1660-9711
Replacement Battery (9 used)	8410-1372

1632-A Inductance Bridge

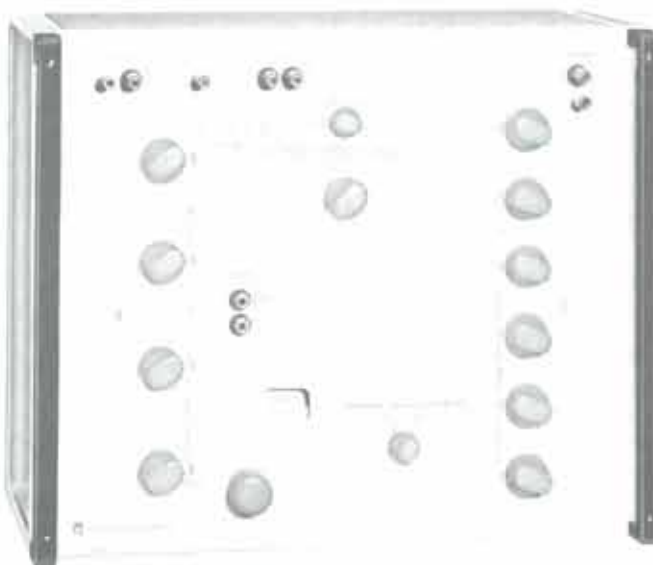

Although available in the Type 1660-A assembly with oscillator and null detector, the 1632-A Inductance Bridge is offered separately for those who have the necessary companion instruments or wish to use frequencies not provided.

The 1632 is ideally suited to the measurement of standard inductors, by direct measurement to $\pm 0.1\%$, or by substitution measurement, in comparison to external standards to a resolution of up to 1 ppm.

SPECIFICATIONS

Note: Specifications for the bridge alone are as given above for the assembly, except as noted.

Mechanical: Rack-bench cabinet. DIMENSIONS (wxhxd): Bench, 19x16x10.5 in. (483x406x267 mm); rack, 19x15.75x8.5 in. (483x400x230 mm). WEIGHT: 40 lb (19 kg) net, 53 lb (25 kg) shipping.

Description	Catalog Number
1632-A Inductance Bridge \oplus	
Bench Mount	1632-9801
Rack Mount	1632-9811

\oplus Federal stock numbers are listed before the Index.

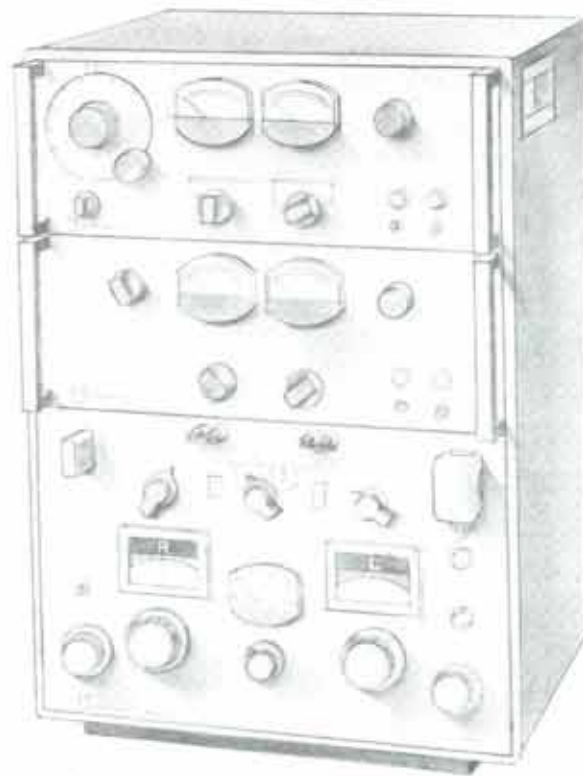

1630-AV Inductance-Measuring Assembly

- test levels from millivolts to kilovolts
- L accuracy 1% (R and Q, 2%)
- discrete frequencies: 50, 60, 100, 120, . . . 15.75 kHz

This assembly is a complete system for the measurement of inductance and loss of coils with ferromagnetic cores. It consists of a 1633 Incremental-Inductance Bridge with specially suited dc and ac power supplies in a cabinet-type rack with all necessary interconnecting cables.

The supplies can produce 200-voltampere outputs into a wide range of load impedances and are designed to pass the large dc and ac currents required.

The 1308-A oscillator provides continuous coverage from 20 Hz to 20 kHz. When measurements are required at frequencies other than those given for the internal detector, the 1232-A Null Detector is recommended.

SPECIFICATIONS

Supplied: This assembly includes the 1633 Incremental-Inductance Bridge, 1265 Adjustable DC Power Supply and 1308 Audio Oscillator and Power Amplifier.

Mechanical: Pedestal cabinet. DIMENSIONS (wxhxd): 22.5x43x20 in. (572x1092x508 mm). WEIGHT: 310 lb (145 kg) net, 460 lb (215 kg) shipping.

Description	Catalog Number
1630-AV Inductance-Measuring Assembly	
115 V, 60 Hz	1630-9827
115 V, 50 Hz	1630-9847
230 V, 60 Hz	1630-9837
230 V, 50 Hz	1630-9857

1633-P1 Range-Extension Unit

The 1633-P1 can be used with the 1633-A Incremental-Inductance Bridge to extend the current ratings to 50 amperes. It connects a 250-watt, 0.1-ohm resistor in parallel with one of the bridge arms.

SPECIFICATIONS

Inductance Ranges: Only a, b, and c ranges of the 1633-A bridge; its readout must be multiplied by 0.1 (otherwise it

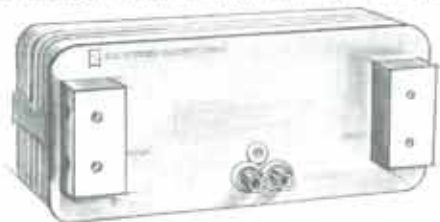

operates normally); upper limits are 100 mH for $f \leq 120$ Hz, 10 mH for $f \leq 1$ kHz.

Accuracy: Additional $\pm 1\%$ error for $f \leq 400$ Hz; correction can be made for errors at higher f . TEMPERATURE COEFFICIENT of resistance: 20 ppm/ $^{\circ}$ C.

Current Rating: 20 A continuous, 50 A intermittent, (total rms); 50 A continuous with forced air cooling.

Terminals: High-current type accommodates wires up to 0.25 in. dia from generator and unknown inductor; binding posts for connection to bridge.

Supplied: Cable, connects to bridge Unknown terminals.

Mechanical: Lab bench cabinet. DIMENSIONS (wxhxd): 10.5x4.25x5 in. (267x108x127 mm). WEIGHT: 5.3 lb (2.4 kg) net, 7 lb (3.2 kg) shipping.

Description	Catalog Number
1633-P1 Range-Extension Unit	1633-9601

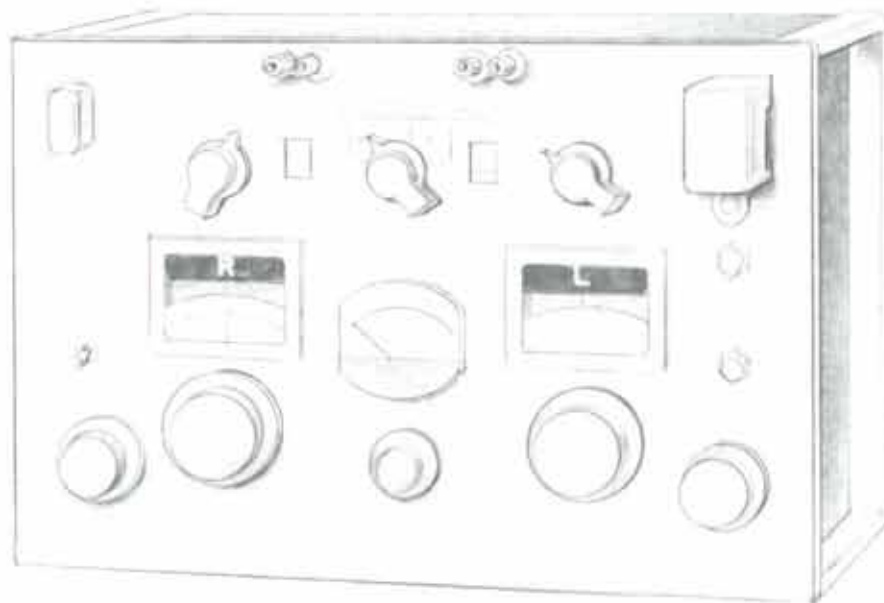

1633-A Incremental-Inductance Bridge

- direct reading at 9 frequencies in series L and R or Q
- 0.2 μ H to 1000 H
- 20 Hz to 20 kHz
- accuracy $\pm 1\%$
- apply up to 1250 V and 50 A, ac and dc
- numerous safety features

The 1633-A was designed primarily for measuring inductance and loss of transformers, chokes, and similar components at very high levels of ac and dc excitation and over a wide frequency range. Easy to operate and flexible in application, it can also measure other nonlinear elements such as Zener diodes, rectifiers, thermistors, and lamps. The bridge contains a highly selective nine-frequency detector for effective harmonic rejection and can be supplied complete with high-power ac and dc supplies as the Type 1630 Inductance-Measuring Assembly.

The incremental-inductance bridge uses a circuit that incorporates active elements* in stable operational am-

plifiers. Although large signal and bias levels may be applied to the unknown indicator, this circuit keeps signals in the bridge small, minimizes corrections, and eliminates sliding balance. Current and voltage in the unknown inductor are nearly identical in magnitude and waveform to those applied at the GENERATOR terminals. In many instances measurements can be made on the inductor while it is actually operating in your circuit.

Up to 7 amperes rms (combined ac and dc) can be passed through the inductor during measurement, up to 50 amperes if you use the 1633-P1 Range-Extension Unit. The impressed voltage can be as high as 1250 volts. Two power supplies are available, a dc supply and a variable-frequency oscillator, which are designed specifically for use with the bridge. Most conventional power supplies are not suitable.

The internal detector is highly selective at nine frequencies between 50 Hz and 15.75 kHz. Owing to high detector sensitivity and low noise, measurements can be made at excitation levels below one volt on the highest inductance ranges and 10 millivolts on the lowest range.

* H. P. Hall, R. G. Fulks, "The Use of Active Devices in Precision Bridges," *Electrical Engineering*, May 1962.

SPECIFICATIONS

Ranges and Accuracy:

Measurement	Frequency	Full-Scale Ranges						Lowest Scale Division	Accuracy
		a	b	c	d	e	f		
Inductance	50, 60, 100, 120 Hz	10 mH	100 mH	1 H	10 H	100 H	1000 H	20 μ H	$\pm(1\%$ of reading or 0.1% of full scale)
	400, 800, 1000 Hz	1 mH	10 mH	100 mH	1 H	10 H	100 H	2 μ H	$\pm(2\pi fL/100 Q_s) \%^*$, $\pm 2\%$ above 10 kHz or $\pm 3\%$ above 15.75 kHz
	10, 15.75 kHz	100 μ H	1 mH	10 mH	100 mH	1 H	10 H	0.2 μ H	
Resistance	All	10 Ω	100 Ω	1 k Ω	10 k Ω	100 k Ω	1 M Ω	10 m Ω	$\pm(2\%$ of reading or 0.1% of full scale) $\pm \frac{4\pi fL_s Q_s}{100} \%^*$
Q		\approx to 1, direct reading at above frequencies Largest scale reading: 1000						0.9	1/Q accuracy = $\pm 2\% \pm 0.001 \pm 0.0005 fL_s \%^*$
Max rms volts		12.5	125	1250	1250	1250	1250		
Min rms volts for 1% accuracy (internal detector)	50, 60 Hz	0.025	0.25	2.5	2.5	2.5	2.5		
	1 kHz	0.006	0.06	0.6	0.6	0.6	0.6		
Max rms amperes**		7	7	7	2	0.7	0.2		
	with extension unit†	50	50	50					

* The frequency-error term is 5 times larger on highest L range.

** Max rms current = $\sqrt{I_{dc}^2 + I_{ac}^2}$

† 1633-P1 Range-Extension Unit contains a 0.1- Ω resistor, which you connect externally to shunt R_s (on the 3 lowest bridge ranges). Inductance and resistance values are reduced by a factor of 10.

Generator: External only (not supplied). For optimum performance when dc bias is used, ac supply must be able to withstand large dc currents in output circuit, and dc supply large ac currents. For dc bias, use 1265-A Adjustable DC Power Supply, 200 W; over the audio-frequency range, use 1308-A Audio Oscillator and Power Amplifier, 200 VA.

Detectors: INTERNAL: Selectively tuned to 50, 60, 100, 120, 400, 800 Hz, 1, 10, and 15.75 kHz; response varies < 3 dB for frequency components within $\pm 1\%$ of the nominal. Response at 2nd harmonic is typically 50 dB lower. EXTERNAL: Use the 1232-A Tuned Amplifier and Null Detector, which is tunable continuously, 20 Hz to 20 kHz.

Available: 1633-P1 Range-Extension Unit, 1232-A Tuned Amplifier and Null Detector, 1308-A Audio Oscillator and Power Amplifier.

Power: 105 to 125 V or 210 to 250 V, 50 to 60 Hz, ≈ 6 W.

Mechanical: Rack-bench cabinet. DIMENSIONS (wxhxd): Bench, 19x12.75x10.25 in. (483x324x260 mm); rack, 19x12.25x8.75 in. (483x311x222 mm). WEIGHT: 31 lb (14 kg) net, 48 lb (22 kg) shipping.

Description	Catalog Number
1633-A Incremental-Inductance Bridge	
115-V Bench Model \diamond	1633-9801
115-V Rack Model	1633-9811
230-V Bench Model	1633-9802
230-V Rack Model	1633-9812

1265-A Adjustable DC Power Supply

The 1265-A supplies dc bias for the 1633-A Incremental-Inductance Bridge. Its characteristics include wide ranges of current and voltage, a passive low-impedance output circuit that will pass high alternating currents, and a choice of voltage or current regulation.

The instrument has four voltage ranges and four current ranges and will deliver its maximum rated power of 200 watts to 8, 80, or 800 ohms. Range switches are interlocked to prevent most likely overload situations. In addition, electronic circuit prevents damage from overload.



SPECIFICATIONS

Full-Scale Output Ranges: 12.5, 40, 125, 400 V dc; 0.16, 0.5, 1.6, 5 A dc; in any combination up to 200 W.

Meters: Voltage and current; ranges switch with output ranges.

Overload Protection: Overload circuit trips at approx $1\frac{1}{2}$ times full-scale current.

Regulation: VOLTAGE OR CURRENT: 0.2% for 10% line-voltage change; 1% for 100% load change. SPEED OF RESPONSE: Approx 0.1 second.

Hum Level (rms): For 60-Hz operation, approx 70 dB below full-scale dc output (55 dB on 5-A ranges); for 50-Hz operation, 6 dB higher.

Power: 105 to 125 or 210 to 250 V, 50 or 60 Hz, 380 W at rated load. (Specify if for 50 Hz.)

Mechanical: Rack-bench cabinet. DIMENSIONS (wxhxd): Bench, 19x7.5x17.25 in. (483x190x438 mm); rack, 19x7x15 in. (483x178x381 mm). WEIGHT: 70 lb (32 kg) net, 124 lb (57 kg) shipping.

Description	Catalog Number
1265-A Adjustable DC Power Supply	
115-V Models	
60-Hz, Bench	1265-9801
60-Hz, Rack	1265-9811
50-Hz, Bench	1265-9803
50-Hz, Rack	1265-9813
230-V Models	
60-Hz, Bench	1265-9802
60-Hz, Rack	1265-9812
50-Hz, Bench	1265-9804
50-Hz, Rack	1265-9814

\diamond Federal stock numbers are listed before the index.



1482 Standard Inductor

- stable within $\pm 0.01\%$ per year
- low, known temperature coefficient
- minimized connection errors
- toroidal — free from external fields

The 1482 is an accurate, highly stable standard of self inductance for use as a low-frequency reference or working standard in the laboratory. Records extending over 16 years, including those of inductors that traveled to national laboratories in several countries for calibration, show long-term stabilities well within $\pm 0.01\%$.

Each inductor is a uniformly wound toroid on a ceramic core. It has a negligible external magnetic field and hence essentially no pickup from external fields. The inductor is resiliently supported in a mixture of ground cork and silica gel, after which the whole assembly is cast with a potting compound into a cubical aluminum case.

Sizes of 1 mH and above have three terminals, two for the inductor leads and the third connected to the case, to provide either a two- or three-terminal standard. The 100- μ H size has three additional terminals for the switching used to minimize connection errors.

For comparing other inductors with these standards, the 1632-A Inductance Bridge is recommended.

SPECIFICATIONS

Inductance Range: See table.

Accuracy of Adjustment: See table.

Calibration: A certificate of calibration is provided with each unit, giving measured values of inductance at 100, 200, 400, and 1000 Hz, with temperature and method of measurement specified. These values are obtained by comparison, to a precision, typically, of better than $\pm 0.005\%$, with working standards whose absolute values, determined and maintained in terms of reference standards periodically certified by the National Bureau of Standards, are known to an accuracy typically $\pm (0.02\% + 0.1 \mu\text{H})$ at 100 Hz.

Stability: Inductance change is less than $\pm 0.01\%$ per year.

Dc Resistance: See table for representative values. A measured value of resistance at a specified temperature is given on the certificate of calibration.

Low-Frequency Storage Factor Q: See table for representative values of Q at 100 Hz (essentially from dc resistance). An individual value of Q, calculated from the measured dc resistance, is given on each certificate of calibration.

Temperature Coefficient of Inductance: Approx 30 ppm per $^{\circ}\text{C}$. Minute temperature corrections may be computed from dc resistance changes. A 1% increase in resistance, produced by a temperature increase of 2.54°C , corresponds to 0.0076% increase in inductance.

Resonant Frequency: See table for representative values. A measured value is given on the certificate of calibration.

Max Input Power: For a rise of 20°C , 3 W; for precise work, a rise of 1.5°C , 200 mW. See table for corresponding current limits.

Terminals: Jack-top binding posts on $\frac{3}{8}$ -in. spacing with removable ground strap.

Mechanical: Lab-bench cabinet. DIMENSIONS (wxhxd): 6.5x6.5x8 in. (165x165x204 mm). WEIGHT: 11.5 lb (5.3 kg) net, 13 lb (6 kg) shipping.

Description	Nominal Inductance	Adjustment Accuracy (Percent)	* Resonant Frequency (kHz)	* Dc Resistance (Ohms)	* Q at 100 Hz	Milliamperes, rms for,		Catalog Number
						200 mW	3 W	
Standard Inductor †								
1482-B	100 μH	± 0.25	2250	0.083	0.76	1550	6010	1482-9702
1482-E	1 mH	± 0.1	800	0.84	0.75	490	1890	1482-9705
1482-H	10 mH	± 0.1	220	8.2	0.77	156	600	1482-9708
1482-L	100 mH	± 0.1	71	81	0.78	50	192	1482-9712
1482-P	1 H	± 0.1	14.6	616	1.02	18	70	1482-9716
1482-T	10 H	± 0.1	4.9	6400	0.98	5.6	22	1482-9720

* Representative values. Actual values given on certificate.

† Federal stock numbers are listed before the Index.



1491 Decade Inductor

- high-Q, 200 and above
- shielded toroidal cores for small mutual inductance little effect from external fields
- sealed against moisture

The 1491 Decade Inductor is an assembly of several 940 Decade-Inductor Units in a single metal cabinet. The units have no electrical connection to the panel, but a separate ground terminal is provided, which can be connected to the adjacent low terminal, leading to the smallest decade.

These inductance decades are convenient elements for use in wave filters, equalizers, and tuned circuits throughout the range of audio and low radio frequencies. As components in oscillators, analyzers, and similar equipment, they are especially useful during the preliminary design period, when you need to vary circuit elements over relatively wide ranges to determine optimum operating values. As moderately precise standards of inductance they have values of low-frequency storage factor, Q, that are much larger than those of air-core coils.

SPECIFICATIONS

Note: See also specifications for 940 Decade Inductor Units.

Frequency Characteristics: Percentage increase in effective series inductance (above the zero-frequency value, L_0) may be obtained by interpolation in accompanying graph for any setting of the highest-value decade used, when LOW terminal is grounded to cabinet.

Zero Inductance: Approx 1 μ H.

Max Voltage: 500 V rms. Switch will break circuit at 500 V if turned rapidly, but voltages above 150 V may cause destructive arcing with switch between detent positions.

Terminals: Binding posts on $\frac{3}{8}$ -in. centers; separate ground terminal provided.

Mechanical: Lab-bench cabinet. DIMENSIONS (wxhxd): Bench, 17x8.75x6.5 in. (432x223x166 mm); rack, 19x8.75x4.88 in. (483x223x124 mm). WEIGHT: 1491-D, bench model, 23 lb (11 kg) net, 30 lb (14 kg) shipping; 1491-G, bench model, 27 lb (12 kg) net, 34 lb (16 kg) shipping; rack models are heavier by 1.75 lb (0.8 kg).

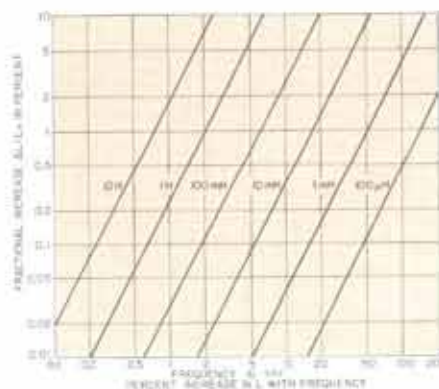

Variation of inductance with frequency for the 1491 Decade Inductors.

Description	Total	Steps	940's Included	Catalog Number
Decade Inductor				
1491-D Bench Rack	11.11 H	0.001 H	E, F, G, H	1491-9704 1491-9714
1491-G Bench Rack	11.111 H	0.0001 H	DD, E, F, G, H	1491-9707 1491-9717

† Federal stock numbers are listed before the Index.



940 Decade-Inductor Unit

Each 940 Decade-Inductor Unit is an assembly of four inductors (relative values, 1, 2, 2, 5) wound on molybdenum-permalloy dust cores, which are combined by switching to give the eleven successive values from 0 to 10. The decade switch has high-quality ceramic stator-and-rotor members and well-defined ball-and-socket detents. All contacts are made of a silver alloy and have a positive wiping action.

SPECIFICATIONS

Accuracy: Each unit is adjusted so that its inductance at zero frequency and initial permeability will be the nominal value within the accuracy tolerance given in the following table:

Unit	940-DD	940-E	940-F	940-G	940-H
Inductance per step	100 μ H	1 mH	10 mH	100 mH	1 H
Accuracy	$\pm 2\%$	$\pm 2\%$	$\pm 1\%$	$\pm 0.6\%$	$\pm 0.6\%$

Frequency Characteristics: For any specific operating frequency, Figure 2 shows the percentage increase in effective series inductance (above the value when $f = 0$), which is encountered with the extreme settings of each of the five decade-inductor units when the chassis is floating. Interpolation may be used for intermediate settings.

Change in Inductance with Current: Fractional change in initial inductance with ac current for each type of toroid is shown in the normal curves, Figure 1, in terms of the ratio of the operating current, I , to I_c , the current for 0.25% change, solid line (0.1%, broken line). For ratios below unity, inductance change is directly proportional to current. Values of I_c , listed below,

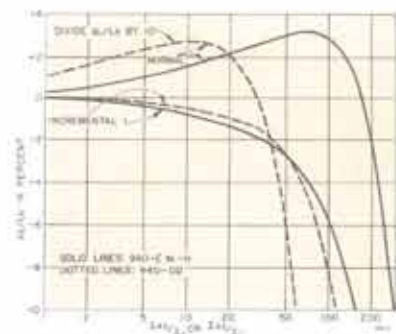

Figure 1. Percentage change in normal and incremental inductance with ac and bias current. Incremental curve is limited to an ac excitation less than I_c .

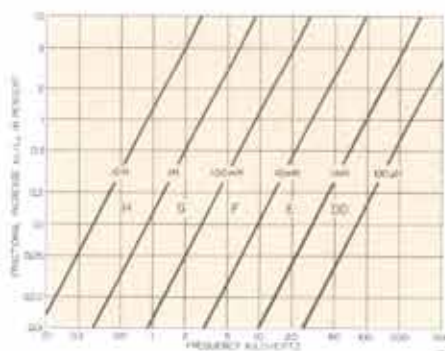

Figure 2. Change in effective inductance with frequency for the 940 Decade-Inductor Units.

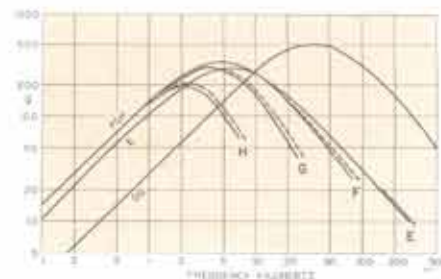

Figure 3. Variation of Q for the maximum inductance of each 940 Decade-Inductor Unit at low excitation levels. Dashed curves correspond to use with chassis floating.

are approximate and are based on the largest inductor in the circuit for each setting.

Incremental Inductance: Dc bias current I_b will reduce the initial inductance as shown in the incremental curves, Figure 1.

Switch Setting	RMS I_c (mA)				
	0.1% Increase	0.25% Increase			
	940-DD	940-E	940-F	940-G	940-H
1	141	17	5.4	1.7	0.54
2, 3, 4	100	12	3.8	1.2	0.38
5, 6, 7, 8, 9, 10	63	8	2.4	0.8	0.24

Storage Factor Q : See Figure 3.

Dc Resistance: Approx 45 Ω per henry.

Temperature Coefficient: Approx -25 ppm per degree C between 16° and 32° C.

Max Safe Current: Approx 200 times the pertinent I_c value (30 times for the 940-DD). Max current engraved on dial.

Terminals: Solder lugs. Circuit insulated from chassis.

Mechanical: Panel-mounting (hardware, dial plate, and knob included). DIMENSIONS (wxhxd): 8x3.5x4.25 in. (204x89x108 mm). WEIGHT: 3.5 lb (1.6 kg) net, 6 lb (2.8 kg) shipping.

Description	Inductance		Catalog Number
	Total	Steps	
Decade Inductor			
940-DD	1 mH	100 μ H	0940-9810
940-E	0.01 H	0.001 H	0940-9705
940-F	0.1 H	0.01 H	0940-9706
940-G	1 H	0.1 H	0940-9707
940-H	10 H	1 H	0940-9708

Ⓜ Federal stock numbers are listed before the Index.

High-Frequency Measuring Systems

RF network analyzer to 500 MHz

Sweep-frequency reflectometer to 18 GHz

Admittance meter and rf bridge

General-purpose and precision slotted lines

Precision directional coupler, detectors, and amplifiers

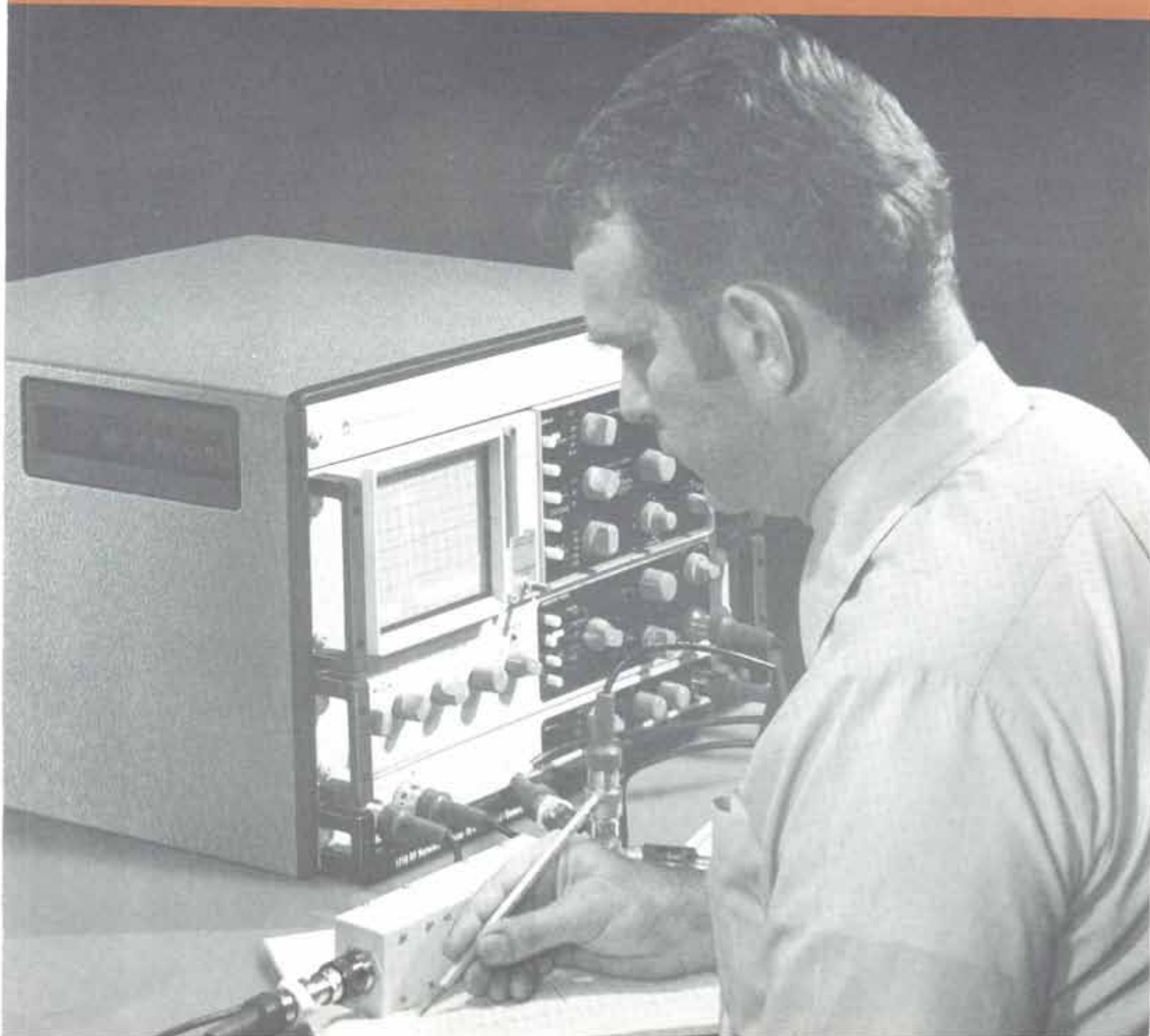

1710 New RF Network Analyzer

for complete rf network analysis:

- wide sweep range, 3 decades, 0.4 to 500 MHz
- wide dynamic range, 115 dB
- fine resolution, 0.005 dB
- three channels
- 50- Ω and 75- Ω measuring circuits
- complex impedance and admittance measurement
- complex transmission and reflection
- direct-reading group delay and test level
- built-in variable-width marker
- pushbutton s-parameter selection
- multiple displays including built-in polar
- fully programmable

Tailored capability The 1710 is a sophisticated, yet simply operated system for accurate measurements of magnitude, phase, and group delay of either of two signals relative to a third reference signal; impedance and immittance measurements are equally simple. The analyzer operates over a broad swept-frequency range of 400 kHz to 500 MHz and a wide dynamic range of 115 dB in either 50- or 75- Ω systems.

Measurements can be made with a 10-kHz or a 100-Hz bandwidth and the results can be displayed for one channel only, both channels alternately, or as a vector difference. The sweep is variable — as wide as 500 MHz or as narrow as 1 kHz, with a choice of log or linear sweep modes and a choice of sweep times from 10 ms to 100 s. A built-in variable-width marker adds to the operating ease.

The basic analyzer consists of a tracking sweep generator, a tracking detector, and a processor — individual units completely integrated into a single system and fully programmable for use in computer-controlled systems. An optional display oscilloscope, polar display capability, and group delay capability can be added to increase the usefulness of the basic system. Five measurement circuits are available to suit various applications and include 50-ohm and 75-ohm transmission tees, 50-ohm and 75-ohm transmission-reflection bridges, and, for the ultimate convenience and versatility, an s-parameter measuring set. A probe is offered for applications that require immittance and impedance measurements.

Time-saving simplicity The 1710 provides complete control over all parameters but does so with such simplicity that calibration, setup, and measurement procedures are reduced to little more than the push of a button and the twist of a knob. Consider, for example, the complete characterization of a 50-to-250 MHz amplifier. **CALIBRATE:** Using a 75- Ω Transmission-Reflection Bridge, set the 1710 controls to their marked initial positions and check the system calibration.

SETUP: Set the sweep controls for the 50-to-250 MHz frequency range and the desired sweep time, and set the

sweep-generator power to the desired input level, as displayed on the scope. Connect the 75-ohm amplifier to the Unknown terminals.

MEASURE: Set the channel selector to B and push the Both button to observe the simultaneous phase and magnitude characteristics (either can be displayed individually, if desired). Vary the input level to measure the gain-compression and saturation characteristics or expand the magnitude display to 0.025 dB per division for a detailed look at the flatness of the magnitude display (a simple turn of the offset control will keep the desired portion on-screen). Push the Delay button to observe the group delay (which can be displayed with the magnitude information, when needed).

Set the channel selector to A to measure both the magnitude and phase of the return loss or set it to AB Alternate for a simultaneous measurement of gain and return loss. For a polar plot, simply push the Polar display button.

Precise data for all needs In all probability, the 1710 will characterize any 400 kHz-to-500 MHz device in your facility and will do so with such speed, accuracy, and simplicity that hours of valuable development or production time can be saved.

You can test nearly any passive device including filters, cables, antennas, switches, di-plexers, couplers, attenuators, components (resistors, inductors, capacitors) and materials such as insulators, dielectrics, and semiconductors. Analyses of active devices are equally facilitated, including complete circuits or networks, amplifiers, ac-

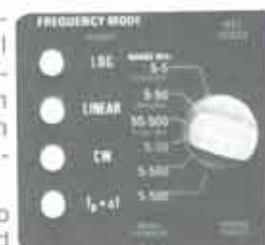
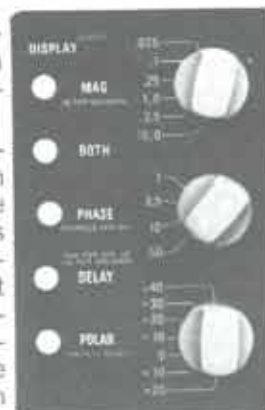

tive filters, monolithic or hybrid circuits, transistors, diodes, and tubes. The S-Parameter Measuring Set is particularly valuable for active devices and includes provision for external bias to each measurement port.

Narrow-band-filter response The excellent frequency stability, extremely low residual fm, and low spurious signal level permit precise frequency response measurements of a wide variety of narrow-band filters. The $f_0 \pm \Delta f$ sweep capability provides a simple, yet highly accurate, method for detailed narrow-band analyses of selected portions of the over-all response.

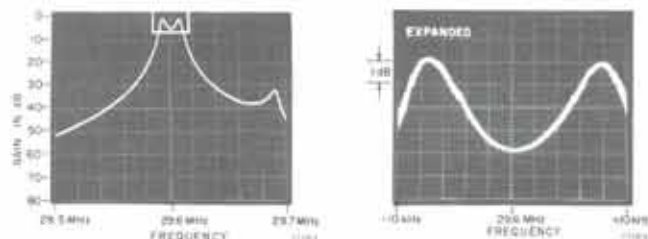

In this example, the characteristics of a crystal filter with a nominal center frequency of 30 MHz are first checked with a frequency resolution of 20 kHz per division and a magnitude resolution of 10 dB per division. A more detailed analysis is then made at 2 kHz per division to provide greater resolution around the center frequency. The measurements were made with a 50- Ω Transmission Tee.

Cable attenuation and return loss The wide sweep range provides a rapid means for comprehensive cable measurements, and the simultaneous display of attenuation and return loss simplifies interpretation.

Here the attenuation and return-loss characteristics of a 50-ohm cable assembly are presented on the display oscilloscope. The signal to the unknown (input level) was set to -10 dBm and is displayed simultaneously with the attenuation (which varies from 10 to 12 dB) and the return loss (which is greater than 30 dB).

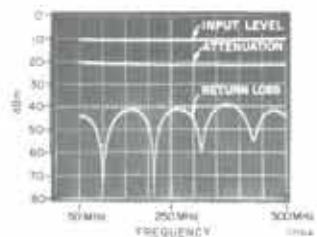

Amplifier gain vs frequency Amplifier-gain characteristics are readily determined from the simultaneous display of the input level and output level. The wide sweep range and the expanded-sweep feature permit displays of the over-all response or detailed portions of it.

Depicted is gain vs frequency of a vhf pre-amplifier with a 30-MHz notch filter. Note that the input level to the amplifier has been adjusted to -40 dBm. To determine the amplifier's saturation characteristics, the input level would be adjusted from -40 dBm toward 0 dBm and the subsequent change in gain observed. Since the measurement is automatic and the results are quickly obtained, displays of this type are very useful for tuning or otherwise adjusting wide-band circuits.

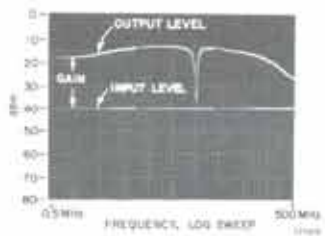

Bandpass filter characteristics Where both phase and magnitude are important, the simultaneous display of both on the rectilinear plot, plus the pushbutton ability to

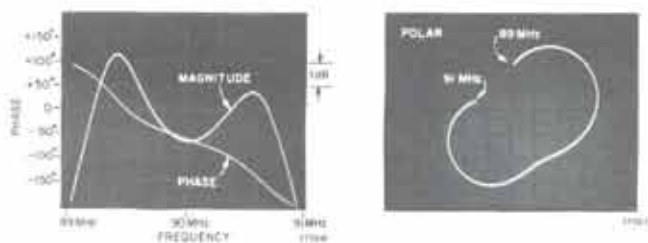

convert to a polar plot, greatly adds to the convenience and usefulness of the measurement.

The example shows the frequency response and phase characteristics of a bandpass filter from 89 to 91 MHz. A 50- Ω Transmission Tee, together with the optional display oscilloscope and polar display capability, makes such measurements possible — quickly and precisely.

Filter comparison Having two measurement channels greatly simplifies testing, particularly since the results from both channels can be displayed simultaneously. This capability is highly desirable for devices such as duplexers, tees, or any other network containing one input and two outputs. It is also useful for comparing one device to another, such as a standard unit.

The response characteristics of two 185-MHz low-pass filters are displayed to determine how closely they match. They were measured using a 50- Ω Transmission Tee and the built-in display oscilloscope.

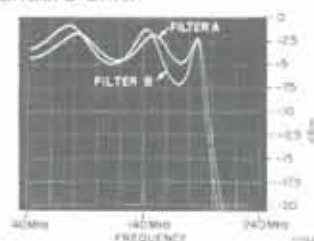

Delay equalization Group-delay measurements can be made simply and directly at the push of a button with the low-cost optional group delay capability. The example shows the combined characteristic of three cascaded delay equalizers using a 50- Ω Transmission Tee.

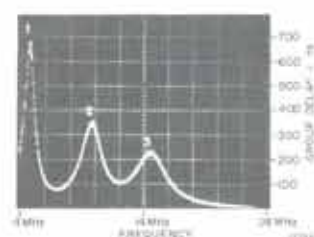

High-attenuation filter response This double exposure demonstrates the ease with which wide-dynamic-range measurements can be made. With normal gain, the entire response characteristics of the notch are not visible. But, by the simple flick of a switch, an additional 20-dB gain is inserted and the upper limit is increased to 100 dB. If desired, the range can be further increased to 115 dB by the use of rf substitution.

The measurements were made on a 75- Ω low-pass filter by the use of a 75- Ω Transmission Tee.

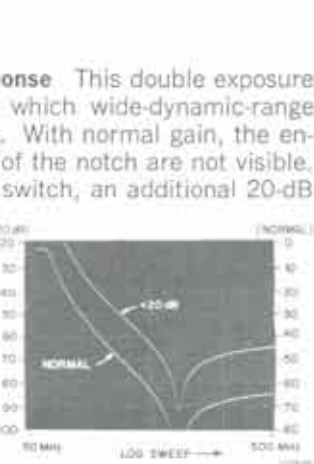

Transistor s parameters The S-Parameter Measuring Set provides measurements of s_{11} , s_{12} , s_{21} , or s_{22} , each at the push of a button. External bias is easily applied and a built-in line stretcher precisely establishes a reference plane to eliminate the effects of coaxial-line lengths of the mounts. Transistor mounts are available to accommodate a wide variety of transistor and diode configurations.

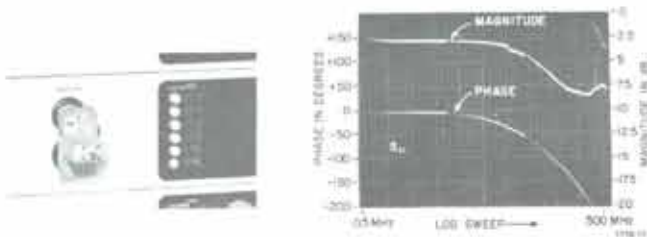

The measurements displayed are the s_{11} characteristics of a transistor attached to the optional S-Parameter Measuring Set by means of a 1607-P41 Transistor Mount.

Filter-response uniformity With a display resolution of 0.005 dB per minor division and the ability to select any portion of the 400 kHz-to-500 MHz frequency range for

observation, highly detailed and accurate analyses of response characteristics are not only possible but extremely simple. A continuously adjustable display offset from +100 to -100 dB is an additional aid in precisely selecting the portion of the characteristic that is of particular interest.

The ± 0.05 -dB response uniformity of the 70-MHz bandpass filter shown, for example, is determined easily by the high sensitivity of the analyzer. The filter was connected to a 50- Ω Transmission Tee.

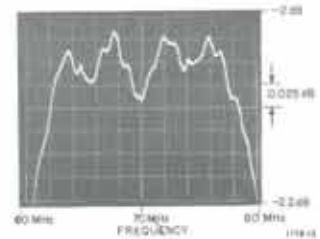

Error Analysis

E (system error) System error varies with the application and the measuring circuit as follows (for the worst cases):

$$\begin{aligned} \text{magnitude } E &= MC + D + FR + DR + CT + DO \\ \text{phase } E &= MC + D + FR + DR + CT + DO \\ \text{polar } E &= \text{magnitude } E + \text{phase } E + A \\ \text{absolute-level } E &= D + FR + CT \\ \text{group-delay } E &= D + A \end{aligned}$$

MC (measuring-circuit error) Measuring-circuit errors are given in the specifications for the individual circuits. For transmission measurements, MC is characterized by the transmission frequency response (can be calibrated out) and the equivalent-source and detector matches (greater than 25 and 30 dB, respectively, under normal operating conditions). For reflection measurements, MC is characterized by the directivity and the reflection frequency response. For absolute-level and group-delay measurements, the MC errors are small and are included elsewhere.

D (display error) This term is associated with the op-

tional display oscilloscope and is equal to the 0.05 div/div vertical linearity, the 0.05 div/div horizontal linearity, and any operator-readout error.

FR (frequency-response error) This term can be calibrated out.

DR (dynamic-response error) For magnitude measurements, there is one dynamic-response error term; for phase measurements, there are two. For absolute-level measurements, the dynamic-response error is included in the frequency-response specification.

CT (crosstalk error) This is given by the crosstalk curve.

DO (display offset error) For magnitude and phase measurements, this term applies only when it is necessary to expand the display about a position other than that used for the initial calibration.

A (miscellaneous errors characterized by accuracy) For polar measurements, this term defines the circle of confusion; for group-delay measurements, it includes errors due to the measuring circuit, frequency response, dynamic response, crosstalk, and display offset.

SPECIFICATIONS

Test Frequency: 0.4 to 500 MHz in 3 bands. (1) 0.4 to 5 MHz, (2) 4 to 50 MHz, (3) 40 to 500 MHz. CW ACCURACY: $\pm 2\%$ of dial setting. CW RESOLUTION: 3 digit with moving decimal; last digit subdivided into 5 parts. CW STABILITY: 0.02% of full band/10 min, after 1-h warmup. RESIDUAL FM: 100, 200, and 1000-Hz rms deviation in 100-Hz system bandwidth for bands 1, 2, and 3 respectively.

Sweep: MODES: Multiband Log, single-band Log or Linear, linear $f_c + \Delta f$. In $f_c + \Delta f$ mode, f_c continuously adjustable across full band; Δf continuously adjustable from zero to full band; 20% ($f_c + \Delta f$) over-range provided on bands 1 and 2; also 9 calibrated Δf positions in 1, 2, 5 sequence in each band. MARKER: Intensified trace displays position of $f_c + \Delta f$ sweep in full band log or linear mode as well as top band of multiband sweep. SWEEP TIME: 0.01, 0.1, 1, and 10 s/band calibrated, plus X1 to X10 continuous: Manual sweep mode converts continuous Time multiplier to manual control. SYNC: Free running. Line triggered, or single sweep selected by panel control; pushbutton and external Trigger.

Test Level (to unknown(s)): 0 to -66 dBm in 10- and 1-dB steps plus continuous vernier ACCURACY: ± 2 dB over full frequency range. SOURCE OUTPUT: +13 dBm max to allow for 13-dB measuring-circuit loss without comparable loss in test-level range.

Measurement Channels: 2 independent measuring detectors (A and B) in addition to a reference detector. MODES: A

only, B only, A/B alternate, A-B vector difference. CHARACTERISTIC IMPEDANCE: 50 or 75 Ω at measuring interface, with 25-dB equivalent source match and 30-dB equivalent detector match (with 1710-P50 or -P75).

Absolute Level Measurements: 80 dB (0 to -80 dBm). RESOLUTION: 10 dBm/div. FREQUENCY RESPONSE (can be calibrated out): ± 2 dB from 0.4 to 500 MHz.

Group-Delay Measurements (optional): 50, 10, 2.5, 1D ns/div (400 to 8D ns full scale), where D = sweep time in ms/sweep width in MHz. RESOLUTION: 4D ns, limited by noise base. DISPLAY OFFSET: +200 to -200D ns, continuous, with resolution of 0.2D ns. ACCURACY: 4D ns \pm 0.1 ns/ns, over a 20-dB magnitude range; 4D ns \pm 0.02 ns/ns with external calibration of sweep time and sweep width.

Magnitude Measurements (loss or gain): >130 dB (0 to -110 dBm normal, -20 to -130 dBm with signal-channel matching pad of +14 dB removed and detector switch at reflection +6-dB position). RESOLUTION: 10, 2.5, 1, 0.25, 0.1, and 0.025 dB/div (80 to 0.2 dB full scale). Polar magnitude displayed as radius of 4-in. dia circle with 0.02-in. spot dia; magnitude at 4-in. dia is adjustable over 80-dB range with zero at center in all cases. FREQUENCY RESPONSE (can be calibrated out): ± 0.2 dB from 0.4 to 200 MHz, ± 0.4 dB from 0.4 to 500 MHz. DYNAMIC RESPONSE: 0.2 \pm 0.005 dB/dB to 10 dB, ± 0.1 dB/10 dB beyond 10 dB. CROSSTALK: See curve. DISPLAY OFFSET: +100 to -100 dB, continuous, dial resolution ± 0.2 dB and accuracy ± 0.001 dB/dB offset.

Phase Measurements: $360^\circ - 180^\circ$ to $+180^\circ$ or 0 to 360°). RESOLUTION: 50, 10, 2.5, and $1^\circ/\text{div}$ (360° to 8° full scale). FREQUENCY RESPONSE (can be calibrated out): $\pm 2^\circ$ from 0.4 to 200 MHz; $\pm 4^\circ$ from 0.4 to 500 MHz. DYNAMIC RESPONSE: ± 0.015 degree/degree ± 0.04 div per major scale div; $\pm 0.5^\circ/10$ dB (2° total for 80 dB). CROSSTALK: See curve. DISPLAY OFFSET: $+200$ to -200° , continuous, with resolution of $\pm 0.2^\circ$ and accuracy of ± 0.005 degree/degree.

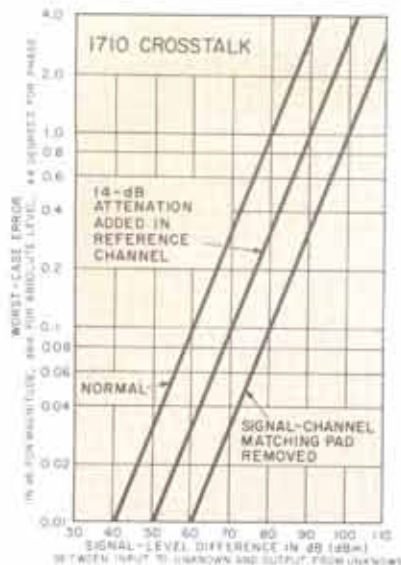

S-Parameter Measurements (optional): When ordered as an option for added capability, set is housed with sweep generator, detector, and processor in larger systems cabinet and includes coaxial interconnections. When ordered as a retrofit kit, set is housed separately from system in its own bench or rack cabinet and does not include coaxial interconnections (1710-P50 required). GR 1607-P transistor-mount accessories are directly compatible. MEASUREMENTS: S_{11} , S_{12} , S_{21} , S_{22} , S_{11} and S_{22} , S_{21} and S_{12} and vector difference between two similar parameters; push-button or remote selected. TRANSMISSION FREQUENCY RESPONSE (can be calibrated out): ± 0.8 -dB magnitude, $\pm 6^\circ$ phase. REFLECTION FREQUENCY RESPONSE: ± 1.5 -dB magnitude (short-circuit/open-circuit), $\pm 8^\circ$ phase. DIRECTIVITY: 40 dB from 1 to 500 MHz, 45 dB from 3 to 400 MHz; minimum frequency for 40-dB directivity under bias (> 27 mA) is (bias in mA $- 25$)/5.5, MHz. BIAS: ± 25 V, 300 mA max. REFERENCE-PLANE EXTENSION: 100 mm, calibrated to 0.1-mm increments. INSERTION LOSS (source to unknown): 16 dB nominal. CHARACTERISTIC IMPEDANCE: 50 Ω only.

Impedance and Admittance Measurements: The 1710-P5 Impedance Probe (available) provides measurements of impedance from 0.5 Ω to 1 M Ω and admittance from 1 μS to 2 μS . Displays magnitude and phase ($|Z| \angle \phi$ or $|Y| \angle \phi$) or polar ($R+jX$ or $G+jB$). MAGNITUDE ACCURACY: $\pm 3\%$ for decade ranges at fixed frequency, for multidecade ranges see curve. Add $\pm 3^\circ$ for sweep frequency. PHASE ACCURACY: $\pm 1.5^\circ$ typical for fixed frequency, $\pm 10^\circ$ for sweep frequency. POLAR ACCURACY: Same as magnitude (see curve); for best accuracy, the smaller of G or B should be $> 1/10$ the larger. BIAS: Bias can be applied at rf input for tests of semi-conductor devices. SUPPLIED: Probe tips with guard, BNC adaptor,

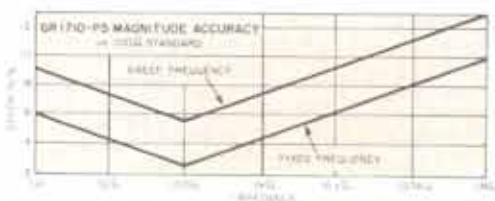

100- Ω Standard Calibrator, sweep adaptor cable, clip terminals, binding-post adaptor, GR900 \oplus adaptor, component test stand, storage box.

Interface: PROGRAMMABILITY: Functions programmable by, and data available as, analog or digital signals. Sweep functions not programmable but frequency programmable by analog voltage and digital band selection. RF level programmable in 10-dB steps by BCD signal and 10 dB continuously by analog voltage. All detector-channel switching and display-range switching programmable by logic-level inputs. X-Y OUTPUTS: 4 V full scale behind 100 Ω for recorder; pen lift output is switch closure with 100-mA sink capability from ± 12 V to lower pen. COUNTER OUTPUT: 10 mV rms into 50 Ω below 6 MHz; frequency is local oscillator (test frequency ± 80 kHz) divided by 1, 10, or 100 on bands 1, 2, or 3. AUXILIARY I-F OUTPUTS: Magnitude linearly related to channel monitored; 80-kHz bandwidth at 80-kHz i-f; channels A, B, and reference. SWEEP TRIGGER INPUT: 2 V required.

Display Oscilloscope (optional): Flat-faced rectangular crt with P7 phosphor and 4 x 5-in. internal parallel-free graticule with 0.5-in. major divisions and 0.1-in. minor divisions.

Polar-Display Capability (optional): MAGNITUDE: Displayed as radius of 4-in. dia circle with 0.02-in. spot dia; magnitude at 4-in. dia is adjustable over 80-dB range with zero at center in all cases. PHASE: 360° continuous, $10^\circ/\text{div}$ on arc of 4-in. dia circle. ACCURACY: 0.1-in. circle of confusion in 4-in. dia display. AUXILIARY GRATICULES (4 supplied): Linear and dB radial scales with 10° phase intervals; full size for direct viewing and parallax-corrected for photography.

Transmission Tees

(available): 50 Ω 1710-P1 (requires 1710-P50 Matching-Pad Cable Set), 75 Ω 1710-P4 (requires 1710-P75 Matching-Pad Cable Set). Three-way power dividers, 3 output ports. FREQUENCY: Dc to 500 MHz. FREQUENCY RESPONSE: Part of system specification. INSERTION LOSS: 10 dB for 1710-P1, 8 dB for 1710-P4; nominal.



Transmission-Reflection Bridges

(available): 50- Ω 1710-P2 (requires 1710-P50 Matching-Pad Cable Set), 75- Ω 1710-P3 (requires 1710-P75 Matching-Pad Cable Set). Include unknown, reflection, and reference ports and matched, open-circuit, and short-circuit standards. FREQUENCY: 0.4 to 500 MHz. TRANSMISSION FREQUENCY RESPONSE (can be calibrated out): ± 0.8 -dB magnitude, $\pm 6^\circ$ phase. REFLECTION FREQUENCY RESPONSE: ± 1.5 -dB magnitude (short circuit/open circuit), $\pm 8^\circ$ phase. DIRECTIVITY: 40 dB from 1 to 500 MHz, 45 dB from 3 to 400 MHz. INSERTION LOSS: 12 dB for 1710-P2, 14 dB for 1710-P4; nominal.



RF Bridges (available separately): The basic bridges of the 1710-P2 and -P3 Transmission-Reflection Bridges are available separately as the 874-BR and 874-BR (75 Ω) RF



Bridges. While these units can be used alone, in pairs, or with the 1710-P1 and -P4 to form special measuring circuits and test fixtures for use with the 1710 RF Network Analyzer, care must be taken to provide a reference signal of suitable level and frequency tracking. For most applications, the 1710-P2 and -P3 Transmission-Reflection Bridges, which do provide the required reference signal, are recommended.

Transistor Mounts (available): Four versions, each accepts up to 4 leads, which are "swallowed" so that lengths (up to 2 in.) and irregularities are of no consequence. Two versions are for grounded-base measurements, two for grounded emitter or collector; they differ in pin spacing. The 0.1-in. dia pin circle is for semiconductor package types: TO-18, 28, 52, 54; MT-30, 38; RO-44, 51, 64, 65, 66, 70, 73, 78; U-3; X-8, etc. The 0.2-in. dia pin circle is for package types: TO-5, 9, 11, 12, 16, 26, 31, 33, 37, 38, 39, 43; MD-14; MM-4, 8; MT-13, 20, 23, 37; RO-2, 3, 4, 5, 10, 24, 30, 33, 34, 46, 48, 49, 50, 61, 62, 79, etc.

Termination Kit (available): Recommended to help establish a zero-phase-reference plane at a known position with respect to the mount and the device under test. The 1607-P40 Termination Kit includes the 874-U10 U-Line Section, 874-WN10 Short Circuit, and 874-WO10 Open Circuit.

Power: 105 to 120 V, 50 to 60 Hz, 115 W max plus 50 W for Display Oscilloscope plus 20 W for S-Parameter Measuring Set.

Mechanical: Bench or rack models. **DIMENSIONS** (wxhxd): Bench, with or without Display Oscilloscope, 19.5x14x20.7 in. (495x356x526 mm); bench with S-Parameter Measuring Set, 19.5x17.2x20.7 in. (495x437x526 mm). **WEIGHT:** Bench with no options, 76 lb (35 kg) net, 96 lb (44 kg) shipping, plus 17 lb (8 kg) for Display Oscilloscope, plus 22 lb (10 kg) for S-Parameter Measuring Set.

Description	Catalog Number
1710 RF Network Analyzer	
Bench Model	(Describe exactly as shown on the left.)
Rack Model	
Select following options, if desired	
OP1 Display Oscilloscope	
OP2 S-Parameter Measuring Set	
OP3 Polar Display Capability	
OP4 Group-Delay Measurement Capability	
Options available for customer installation	
OP1R Retrofit Kit (Display Oscilloscope)	1710-9611
OP3R Retrofit Kit (Polar Display)	1710-9614
OP4R Retrofit Kit (Group Delay)	1710-9615
1713 S-Parameter Measuring Set*	
Bench Model	1713-9600
Rack Model	1713-9601
Service Kit , for maintenance ease, includes: 3 extender boards, 2 GR874 [®] adaptors with SMA plugs, and a GR874-to-GR874 patch cord	1710-9510
Accessories Available	
1710-P1 Transmission Tee (50 Ω)*	1710-9601
1710-P2 Transmission-Reflection Bridge (50 Ω)*	1710-9602
1710-P3 Transmission-Reflection Bridge (75 Ω)**	1710-9603
1710-P4 Transmission Tee (75 Ω)**	1710-9604
1710-P5 Impedance Probe, for impedance and admittance measurements	1710-9605
1710-P50 Matching-Pad Cable Set (50 Ω)	1710-9650
1710-P75 Matching-Pad Cable Set (75 Ω)	1710-9675
Transistor Mounts, for S-Parameter Measuring Set (OP2 or 1713)	
With 0.1-in. pin circle:	
1607-P43, Grounded Base	1607-9643
1607-P44, Gnd Emitter or Collector	1607-9644
With 0.2-in. pin circle:	
1607-P41, Grounded Base	1607-9641
1607-P42, Gnd Emitter or Collector	1607-9642
1607-P40 Termination Kit	1607-9640

* Requires a 1710-P50 Matching-Pad Cable Set (50 Ω).

** Requires a 1710-P75 Matching-Pad Cable Set (75 Ω).

Extended Capability

2260 RF Network Analyzer System

This computer-controlled system is based on the 1710 RF Network Analyzer, providing accurate transmission and reflection measurements from 400 kHz to 500 MHz. Because of its high speed and operating simplicity, this is an excellent investment for production applications and design or research applications that involve a large number of measurements.

The system typically includes a synthesizer and offset generator, tracking detector and display processor, display oscilloscope, computer and computer interface unit, teletypewriter, rf interface unit, and desk console. Accessories for both 50-ohm and 75-ohm measurements are available as are such options as a synthesizer for resolution to a fraction of 1 Hz, large-screen display oscilloscope, special rf interface units, device adaptors

and measurement adaptors, high-speed paper tape reader or magnetic tape unit, X-Y plotter, and programmable power supplies.

The 2260 RF Network Analyzer System is another in the System's 2200 family — a family characterized by high performance, simple programming and operation, supreme flexibility, and relatively low cost.



Synthesizer Systems

These systems incorporate a tracking synthesizer in place of the normal tracking oscillator. The resultant outstanding frequency resolution and noise reduction lend these systems to precision tests on narrow-band devices such as crystal filters.



Dual-Processor Systems

For independent measurements of each unknown channel, including separate settings of resolution, offset, and bandwidth, the 1710 can be equipped with two processors and two display oscilloscopes. This system provides a wide variety of measurement combinations, including simultaneous polar plots of return loss and rectilinear plots of transmission characteristics or vice versa; simultaneous displays of transmission group delay and return loss, and displays of multiple characteristics of a single parameter such as both a polar and rectilinear display of transmission characteristics or return loss.



1715 Sampling X-Y Recorder

This recorder attaches simply to the 1710 and provides a large, 8½x11- or 11x17-inch, recording of the measurements. It is an excellent accessory for applications where permanent records are required, such as for statistical analyses or documented performance verification. The sampling feature provides fast, pushbutton recordings of any oscilloscope display, even while the analyzer sweeps at a very high rate, and is required to obtain hard-copy group delay plots.



1716 Reference Storage Unit

The 1716 stores a reference or zero-line trace in a digital memory so that it may be subtracted from subsequent measurements as a frequency-response correction. For example, with this accessory, a frequency-response flatness of 0.025 dB can be achieved over the full 500-MHz operating band of the 1710 Network Analyzer.



1717 Counter-Marker Generator

The 1717 provides five continuously adjustable frequency markers on the display oscilloscope or X-Y plotter. The marker frequencies are precisely determined from a digital counter incorporated in the unit.





1641 Sweep-Frequency Reflectometer

- 20 MHz to 18 GHz
- direct reading in SWR and loss
- simple setup — accurate results
- unusually high directivity
- precalibrated operation
- complete — add only source

Simple setup The 1641 measures standing-wave ratios from 1.005 to infinity and insertion loss from 0 to 50 dB over a frequency range of 20 MHz to 18 GHz — single or swept frequency and direct reading! It's not just an indicator of transmitted and return signals; it contains all the required coaxial hardware including directional couplers, detectors, and terminations. Once calibrated, it requires no recalibration after range changes.

Accurate measurements The 1641 is an economical, yet highly accurate, reflectometer with the added advantages of simplicity and speed of operation. Having few, if any, intrinsic errors (residual or operational) this reflectometer eliminates the need for computing corrections. You can spend your time making measurements, not calculations.

Versatile measurements The GR sweep-frequency reflectometer meets the requirements of most common industrial and military specifications for production testing and quality-control procedures. It can be used for the adjustment of device parameters, data collection, and GO, NO-GO testing against established limits.

The 1641 features a broad frequency band, displays SWR and loss simultaneously, and incorporates a sweep mode that is particularly useful for the search and identification of resonances. Thus, cables and other transmission networks can be quickly analyzed, and filters,

cavities, and couplers can be easily adjusted for the desired performance.

The unknown can be one-, two-, or multi-port, passive or active, bi- or unidirectional. Vital characteristics can be measured of attenuators, isolators, power dividers, terminations, loads, switches, couplers, amplifiers, and what all. Antenna SWR measurements are a natural. By measurement of the insertion loss through a transmission path between two antennas, the characteristics of the antennas and those of the intervening dielectric material can also be analyzed. The resolution of the 1641 even permits measurements of connectors and other low-SWR devices.

Automatic measurements The 1641 can be remotely programmed, a feature that permits computer-controlled tests and automatic data acquisition when programmable sources and suitable data conversion, processing, and recording instruments are used.

Signal source Although the 1641 depends on an external source of test signals, its requirements aren't stringent — 10 mW into 50 Ω or, for greater resolution, 100 mW. The source should be capable of 10-kHz modulation and of output leveling controlled by signals from the 1641. A source with 1-kHz internal modulation can be used.

Sweep-frequency display, the 1641-Z For a display of sweep-frequency measurements, the 1641 can be ordered with a Tektronix* Type R564 Storage Oscilloscope and two Type 2A63 Plug-ins — completely assembled as the Type 1641-Z Sweep-Frequency Reflectometer. Other oscilloscopes, with a vertical sensitivity of 0.1 per cm and a horizontal sensitivity to suit the selected sweep generator, are adequate but a storage oscilloscope is recommended for use at the slow sweep rates required for low-level (low-SWR and high-attenuation) measurements.

* Registered trademark of Tektronix Inc.

—See **GR Experimenter** for March-April, 1969 and Oct/Dec 1970.

SPECIFICATIONS

Frequency: 20 MHz to 18 GHz, covered by 3 rf units with overlapping ranges, as tabulated.

RANGE of frequency, f	20 to 1500 MHz	0.5 to 7 GHz	1 to 18 GHz
Measurement Accuracy for return-loss and SWR, % of Γ of device being measured, for large Γ . Specified for fixed and swept frequency.	3%, fixed 4%, swept	6%, fixed 11%, swept	1 to 8%, fixed 4 to 11%, swept
Directivity , min, significant for measurements of small reflection coefficient Γ .*	40 dB	40 dB, $f < 4$ 36.5 dB, $4 < f$	34 dB, $f < 8$ 30 dB, $8 < f < 16$ 28 dB, $16 < f$
Residual SWR, max, corresponding to above directivity	1.02	1.02, $f < 4$ 1.03, $4 < f$	1.04, $f < 8$ 1.068, $8 < f < 16$ 1.08, $16 < f$
Insertion-Loss Accuracy , where L is insertion loss (in dB) of device being measured. Specified for fixed and swept frequency.	± 0.1 dB ± 0.015 L, for fixed-frequency measurements ± 0.3 dB ± 0.015 L, for swept-frequency measurements		
Equivalent Source Match (max SWR looking into the unknown connector)*	1.03	$1.02 + 0.02 f_{GHz}$	$1.04 + 0.012 f_{GHz}$ except 1.18, $12 < f$
Residual Detector Match to unknown device, max SWR	$1.01 + 0.007 f_{GHz}$	$1.01 + 0.007 f_{GHz}$	$1.02 + 0.005 f_{GHz}$
Connectors , for source for unknown device	GR874 GR900, 14 mm	GR874 GR900, 14 mm	Type N APC-7, 7 mm

* Also see curve.

Characteristic Impedance: 50 Ω , nominal.

RF Signal to Unknown Device: 100 μ W, typical.

SWR Ranges: 1.005 to 2.0 with source of 100 mW (1 W max), 1.02 to ∞ with source of 10 mW (1 W max). Individual meter-scale ranges are 1.005 to 1.03, 1.02 to 1.10, 1.05 to 1.35, 1.2 to 2.0, and 2.0 to ∞ .

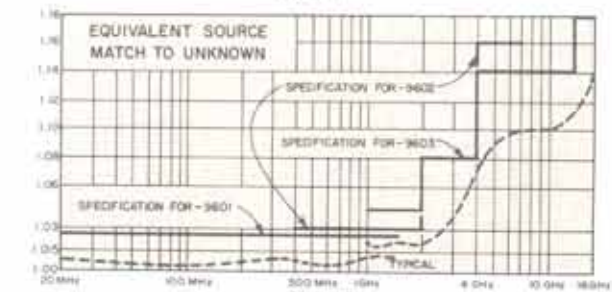
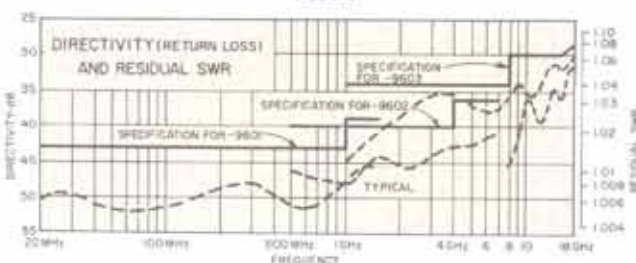
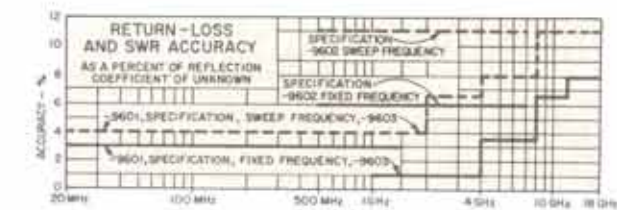

Insertion and Return-Loss Ranges: 10 to 50 dB with source of 100 mW (1 W max), 0 to 40 dB with source of 10 mW (1 W max). Individual meter-scale ranges of 0 to 13, 10 to 23, 17 to 30, 27 to 40, and 37 to 50 dB.

Outputs: MODULATION: 10 kHz, on-off, positive and negative, 0 to 15 V, 400- Ω internal impedance, 1-k Ω min load impedance. DC SIGNAL OUTPUT: ≥ 1 V into 1 k Ω .

Programmable Functions: Meter full scale, meter indication, meter display (SWR, loss, or both), meter-scale lamps, and display time constant are all remotely programmable by closures to ground.

Supplied: WITH 1641 AND 1641-Z: Calibrated graticule for Tektronix R564 oscilloscope, BNC-to-BNC and GR874-to-BNC

patch cords, and power cord. WITH 1641-9601 AND -9602 RF UNITS: 900-W100 Standard 100- Ω Termination, 900-WNC Standard Short-Circuit Termination, 1641-9606 Transfer Detector (14-mm connector) and GR874 patch cord. WITH 1641-9603 RF UNIT: 1641-6904 Transfer Detector (7-mm connector), and 1641-P11 Short/Open Termination.

Required: RF SOURCE: Fixed or swept frequency with 10- to 100-mW leveled output (1 W max). OSCILLOSCOPE: Preferably use a storage scope or dc recorder to display sweep-frequency data (fixed-frequency data are displayed on panel meter). FOR 1641-9603 HIGH-FREQUENCY RF UNIT: 50- Ω termination (Americon 7000-6100 or Weinschel 1404 GPA); for source cables, at 1 to 13 GHz, standard type N patch cords with male connectors, and at 13 to 18 GHz, 0.141 semi-rigid cable with male type N connectors.

Available: Tektronix R564B oscilloscope with 2A63 Differential Amplifier Plug-ins (included with 1641-Z), 1641-9605 Kit including carrying case with GR900[®] adaptors to N and SMA; GR874[®] adaptors to TNC, N, and BNC; and 900-W50 50- Ω Standard Termination.

Power: 100 to 125 or 200 to 250 V, 50 to 60 Hz, 5 W max.

Mechanical: Bench or rack models. DIMENSIONS (wxhxd): 1641 bench, 19.5x12x23 in. (495x305x584 mm); 1641 rack, 19x16.5x20.5 in. (483x419x521 mm). WEIGHT: 1641 bench mainframe, 42 lb (20 kg) net, 91 lb (42 kg) shipping; 1641 rack mainframe, 35 lb (16 kg) net, 84 lb (38 kg) shipping; 1641-9601 RF UNIT, 13 lb (6 kg) net. 1641-9603 RF UNIT: 3.5 lb (1.6 kg) net.

Description	Catalog Number	
	Bench Models	Rack Models
1641 Sweep-Frequency Reflectometer		
20 MHz to 1.5 GHz	1641-9702	1641-9712
20 MHz to 7 GHz	1641-9701	1641-9711
20 MHz to 18 GHz*	1641-9704	1641-9714
20 MHz to 18 GHz	1641-9705	1641-9715
500 MHz to 7 GHz	1641-9703	1641-9713
500 MHz to 18 GHz	1641-9706	1641-9716
1 GHz to 18 GHz	1641-9707	1641-9717
1641-Z Sweep-Frequency Reflectometer, with display oscilloscope		
20 MHz to 1.5 GHz	1641-9902	1641-9912
20 MHz to 7 GHz	1641-9901	1641-9911
500 MHz to 7 GHz	1641-9903	1641-9913
Transfer Detectors, included (where appropriate) with 1641 and 1641-Z; not included with RF Units purchased separately		
20 MHz to 7 GHz		1641-9606
1 GHz to 18 GHz		1641-9604
RF Units, to fill partially equipped models		
20 MHz to 1.5 GHz		1641-9601
500 MHz to 7 GHz		1641-9602
1 GHz to 18 GHz		1641-9603
1641-9605 Accessory Kit		1641-9605

* Includes all three RF Units.
U.S. Patent Number 3,479,587.

1602-B UHF Admittance Meter

- 20 MHz to 1.5 GHz
- direct-reading conductance and susceptance
- measures SWR directly



Versatile building block This null-type instrument measures complex impedance and admittance in coaxial systems and, as a reflectometer, will determine SWR, impedance magnitude, and reflection coefficient magnitude. It can be used to adjust a network to a predetermined admittance, to match one network to another, and to match antennas and other networks to 50-ohm circuits.

A broad line of accessories adapts the 1602-B to specific measurements, for example:

Constant-Impedance Adjustable Line The 874-LK20L can be set to one-half wavelength to eliminate corrections for the length of transmission line between the unknown and the measuring point. When the line is set to one-quarter wavelength, the Admittance Meter dials read in impedance parameters, i.e., the series resistance and reactance of the unknown.

874-UBL Balun for use with balanced impedances.

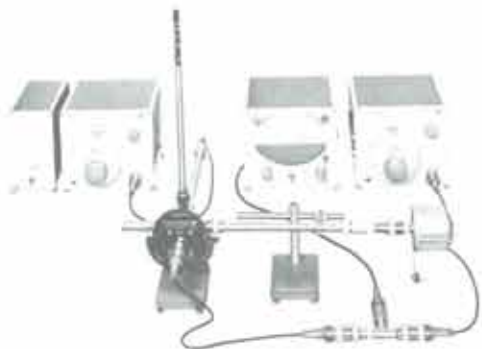

The Admittance Meter assembled for component measurements, with unit oscillator and 1241 Detector. A line stretcher (Type 874-LKL) connects the component mount to the unknown terminal of the Admittance Meter.

874-ML Component Mount for the connection of lumped elements (resistors, capacitors, or inductors).

Description The 1602-B UHF Admittance Meter comprises three identical loops, in parallel, driving a null detector and magnetically coupled to three coaxial lines. All these lines are fed from the same voltage so the current in each line, hence the magnetic field, is proportional to the terminating impedance. One of these lines is terminated with a standard resistance, one with a reactance standard, and one with an unknown admittance. In operation, the coupling of the loops must be adjusted simultaneously until a null is obtained on the detector. Each loop has a calibrated scale and the settings at null condition indicate the value of the unknown device.

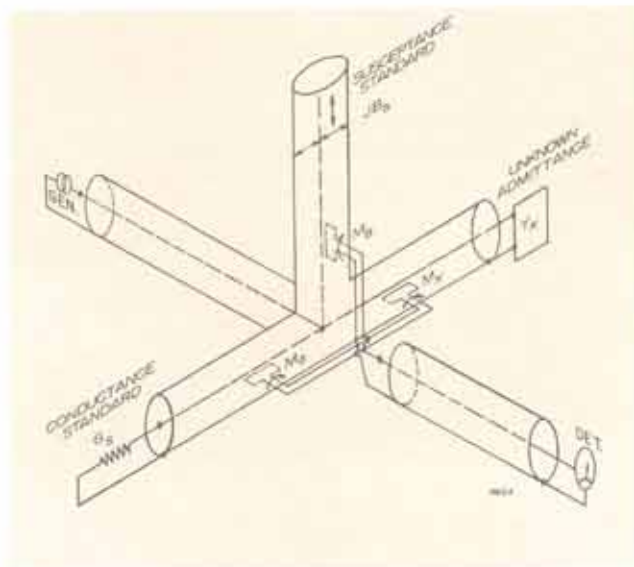

SPECIFICATIONS

Frequency: 40 MHz to 1.5 GHz, direct reading; to 20 MHz with a frequency correction applied to susceptance reading.

Conductance: 0.01 to 4000 m Ω .

Susceptance: -4000 to +4000 m Ω .

Accuracy (both conductance and susceptance): $\pm(3\% + 0.2 \text{ m}\Omega)$ for 0 to 20 m Ω , $\pm(3\sqrt{M} + 0.2 \text{ m}\Omega)$ above 20 m Ω (where M is scale multiplying factor), up to 1 GHz; $\pm(5\% + 0.2 \text{ m}\Omega)$ to 1.5 GHz. For matching of impedances to 50 Ω , accuracy is $\pm 3\%$ up to 1.5 GHz.

Supplied: Two 1602-P4 Terminations as conductance standards, one 1602-P1 Adjustable Stub and one 1602-P3 Variable Air Capacitor as susceptance standards, two GR874 patch cords to connect to generator and detector, 1602-P10 and -P11 Multiplier Plates, and a wooden storage case.

Required: GENERATOR: Must supply 1 to 10 V. GR high-frequency oscillators recommended. DETECTOR: Sensitivity of 10 μV needed. 1241 Heterodyne Detector recommended.

Available: 874-FBL Bias Insertion Unit, coaxial adaptors, line-stretcher, balun, component mount, Smith charts.

Mechanical: TERMINALS: GR874 coaxial connectors which can easily be converted to type N or other common connector types by means of GR874 adaptors. DIMENSIONS (wxhxd): 5.5x7.5x5.5 in. (140x190x140 mm). WEIGHT: 8.5 lb (3.8 kg) net, 18 lb (8.5 kg) shipping.

Description	Catalog Number
1602-B UHF Admittance Meter	1602-9702
874-LK20L Constant-Impedance Adjustable Line	0874-9631
874-UBL Balun	0874-9921
874-ML Component Mount	0874-9663

⊗ Federal stock numbers are listed before the index.



1606-B Radio-Frequency Bridge

- 400 kHz to 60 MHz
- direct reading in ohms
- adaptable to coaxial connectors
- accurate, compact, simple operation

The 1606-B accurately and easily measures the resistance and reactance of antennas, transmission lines, networks, and components. It is particularly well suited for measuring low values of impedance of rf devices. Its range can be extended by means of an external parallel capacitor to measure high impedances.

Precision Coaxial Connections In this latest model of the popular 1606 RF Bridge, the Unknown terminals are adaptable to coaxial connectors, in particular the GR900. This is a significant advantage that not only permits the measurement of components having coaxial fittings but also ensures better repeatability and more accurate definition of the measurement plane. This permits the 1606 to be precision calibrated against coaxial standards such as the 1406 Coaxial Capacitance Standards and the vari-

ous GR900® precision components: open- and short-circuits, 50-, 100-, and 200-ohm Standard Terminations, and the various lengths of precision air line.

Accessory Adaptor Kit With the 1606-P2 adaptor kit, the 1606-B can be fitted to accept GR900 and GR874® connectors (the adaptors include compensation to match 50-ohm standards and components). The kit will also adapt to a 14-mm flange connector (a GR900 flange is included to convert GR900 connectors), or to other common connectors (N, BNC, TNC, etc) by the use of GR900 adaptors.

Description Measurements are made by a series-substitution method in which the bridge is first balanced with a short circuit across the Unknown terminals. The short is then removed, the unknown impedance connected, and the bridge rebalanced.

The entire mechanical design is such that the instrument can operate under difficult environmental conditions similar to those specified for testing military electronics equipment. The 1606-B bridge is therefore an excellent instrument for field use.

SPECIFICATIONS

Ranges of Measurement	Accuracy
<p>Reactance: $\pm 5000 \Omega$ at 1 MHz. This range varies inversely as the frequency; at other frequencies the dial reading must be divided by the frequency in MHz.</p> <p>Resistance: 0 to 1000 Ω.</p>	<p>Reactance: At frequencies up to 5 MHz, $\pm 2\% \pm (1 + 0.004 Rf) \Omega$; 5 to 50 MHz, $\pm 2\% \pm (1 + 0.0008 Rf) \Omega$; where R is the measured resistance in ohms and f is the frequency in MHz.</p> <p>Resistance: At frequencies up to 50 MHz,</p> $\pm \left[1\% + 0.0024R \left(1 + \frac{R}{1000} \right) \right] \% \pm \frac{10^{-4} X}{f} \Omega + 0.1 \Omega$ <p>(where X is the measured reactance in ohms). Subject to correction for residual parameters.</p>

Frequency: 400 kHz to 60 MHz.

Satisfactory but somewhat less accurate operation can be obtained at frequencies as low as 100 kHz and somewhat above 60 MHz.

Generator: External only (not supplied), to cover desired frequency range. Recommended, Type 1211-C and Type 1215-C Unit Oscillators, Type 1330-A Bridge Oscillator, Type 1310-A Oscillator, Type 1003 Standard-Signal Generator.

Detector: External only (not supplied). A well shielded radio receiver is recommended.

Supplied: 2 leads of different lengths to connect unknown impedance to bridge terminals; $\frac{1}{2}$ -in. spacer and $\frac{3}{4}$ -in. screw to mount component to be measured directly on bridge terminals; 874-R22LA Patch Cord.

Available: 1606-P2 PRECISION COAXIAL ADAPTOR KIT.

Mechanical: Bench cabinet. DIMENSIONS (wxhxd): 12.5x9.5x10.25 in. (318x242x261 mm). WEIGHT: 23 lb (11 kg) net, 30 lb (14 kg) shipping.

SPECIFICATIONS FOR 1606-P2

Capacitance Added: By adaptor to GR900, 0.38 pF at reference plane (less fringing capacitance); by flange adaptor, 0.18 pF.

Weight: Net, 10 oz (283 g); shipping, 12 oz (340 g).

Description	Catalog Number
1606-B Radio-Frequency Bridge	1606-9702
1606-P2 Precision Coaxial Adaptor Kit	1606-9602

Ⓜ Federal stock numbers are listed before the Index.



874-LBB Slotted Line

- 300 MHz to 9 GHz
- low residual SWR
- rugged construction
- many lines in one with GR874® adaptors

A basic UHF measurement tool A slotted line is one of the most important basic measuring instruments in high-frequency work. It is used to determine the standing-wave pattern of the electric field in a coaxial transmission line; from this knowledge, several circuit characteristics can be determined of a circuit connected to the load end of the line. For example, the degree of mismatch (usually expressed as SWR) between the load and the transmission line can be calculated from the ratio of the maximum amplitude of the wave to the minimum. The load impedance can be calculated from the SWR and the position of the voltage minimum on the line. Electrical length and time delay can also be measured accurately. These capabilities make the slotted line a valuable instrument for measurements on antennas, components, coaxial elements, networks, transistors, and diodes.

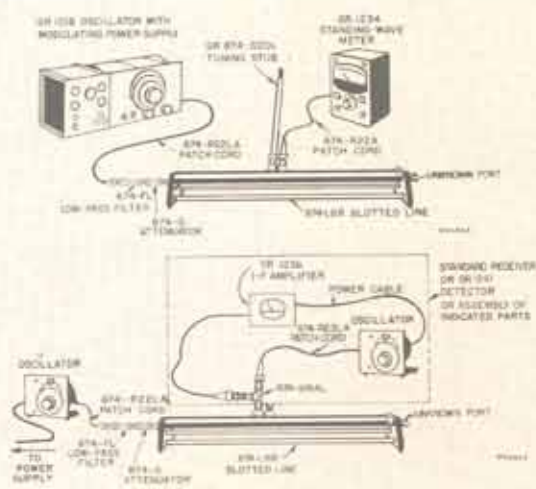

Typical measurement setups showing use of slotted line, SWR indicator (upper) and heterodyne detector (lower).

Twenty-two lines in one The 874-LBB can be converted in seconds to interface with any of the popular UG connectors by use of GR874 low-SWR adaptors, available for BNC, C, HN, Microdot, N, SMA, SC, TNC, GR900, and Amphenol APC-7 connectors. A complete set of adaptors will convert the 874-LBB into the equivalent of 22 low-SWR slotted lines.

The 874-LBB is a 50-ohm, air-dielectric coaxial line whose electric field is sampled by a probe that projects through a longitudinal slot in the outer conductor. The

probe rides on a carriage driven by a pulley-and-cord linkage conveniently operated from one end of the line. A source of about one milliwatt rf power is adequate for most measurements. The detector can be a 1-kHz standing-wave indicator such as the GR 1234 or a heterodyne detector such as the GR 1241. In the former case, rf detection takes place in a diode detector built into the carriage.

SPECIFICATIONS

Frequency: 300 MHz to 8.5 GHz, usable to 9 GHz. Operates below 300 MHz (where probe travel equals $\frac{1}{2}$ wavelength) if extended with lengths of GR874 air line or with another slotted line in series.

Probe: TRAVEL: 50 cm; scale in cm with 1 mm per division. SCALE ACCURACY: $\pm(0.1 \text{ mm} + 0.05\%)$. PICKUP CONSTANTCY (flatness): $\pm 1.25\%$.

SWR: $<1.01 + 0.0016 (f_{\text{GHz}})^2$ up to 7.5 GHz; <1.10 to 8.5 GHz.

Characteristic Impedance: $50 \Omega \pm 0.5\%$.

Supplied: Storage box, rf probe, 2 microwave diodes, Smith Charts.

Required: 874-D20L Adjustable Stub for tuning diode when audio-frequency detector such as GR 1234 is used, suitable generator and detector, one each 874-R22LA and 874-R22A Patch Cords.

Available: Oscillators, power supplies, s-w meter, detectors, 50- Ω air lines, adaptors, and terminations.

874-LV Micrometer Vernier:

For precise measurements of high SWR (>10) by width-of-minimum method, and for precise phase measurements. Micrometer head, calibrated to 0.001 cm, is mounted on arm that attaches to rear base rod of slotted line. One turn of barrel advances head 0.5 mm; maximum range is 2.5 cm, can be read to ± 0.002 cm.

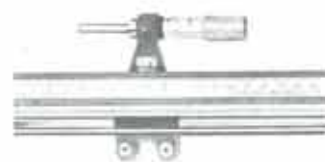

874-LV Micrometer Vernier

874-EKA Basic Slotted-Line Kit: For SWR and impedance measurements. Includes 874-LBB Slotted Line (does not include generator and detector); 25-ft ea of 874-A2 and -A3 coaxial cable; 2 ea 874-BBL, -B, -CA, -C8A, -CLA, -C58A, -CL58A, -PL58A, and -PRL58A connectors; 874-D20L and -D50L adjustable stubs; 874-LAL adjustable line; 874-QBJL, -QNJL, and -QNPL adaptors; 874-R22A, -R22LA, and -R34 patch cords; 874-TL tee; 874-W50BL, -WN, and -WO terminations, 874-TOK tool kit; and 874-Z stand.

Mechanical: DIMENSIONS (wxhxd): 26x4.5x3.5 in. (660x114x 89 mm). WEIGHT: 8.5 lb (3.9 kg) net, 23 lb (11 kg) shipping.

Description	Catalog Number
874-LBB Slotted Line	0874-9651
874-EKA Basic Slotted-Line Kit	0874-9521
874-LV Micrometer Vernier	0874-9652

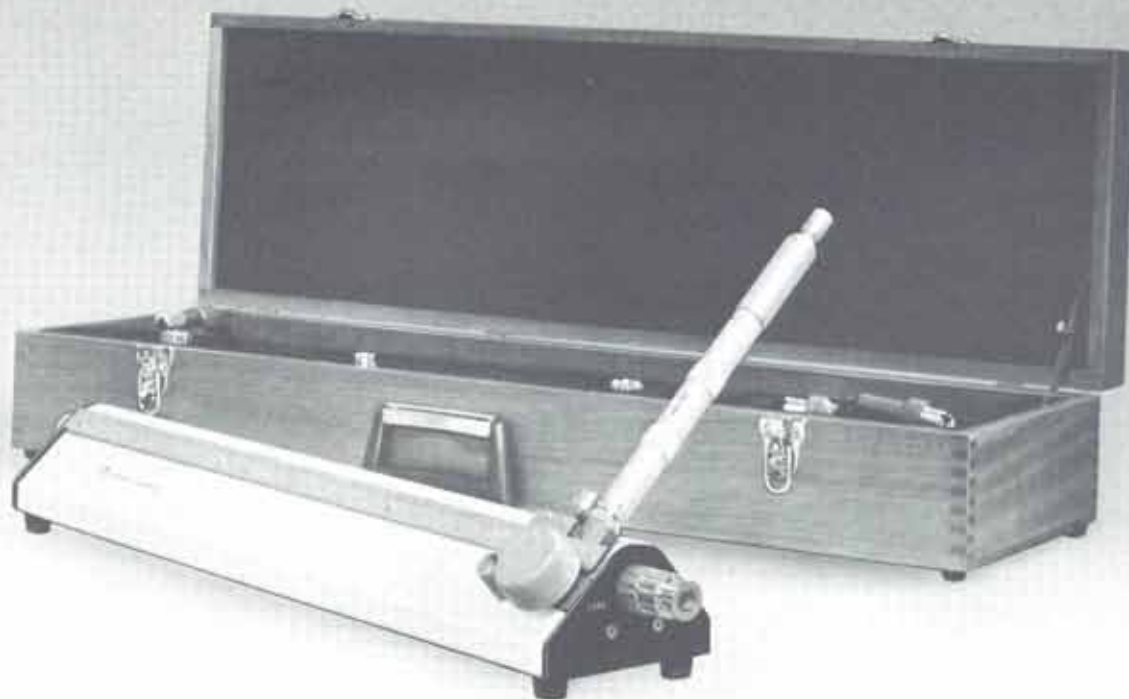

900-LB Precision Slotted Line

- 300 MHz to 8.5 GHz
- extremely low SWR
- impedance is $50 \Omega \pm 0.1\%$
- adaptable with precision to other connectors

Unparalleled precision The most precise coaxial connector, the GR900, and a nearly perfect section of coaxial transmission line combine to give the 900-LB Precision Slotted Line unparalleled performance specifications. The residual SWR of the instrument is that of its GR900® connector: $1.001 + 0.001 f_{GHz}$. For those whose applications demand the ultimate in accuracy, the 900-LB can be calibrated against a 900-LZ Reference Air Line, an impedance standard with a SWR under 1.0025 at 9 GHz.

In the field of microwave impedance measurement, the slotted line is the fundamental instrument, because of its inherent accuracy, broadband characteristics, and phase-measuring capabilities. Among the many transmission-line parameters that can be determined with the slotted line are SWR, reflection-coefficient magnitude and phase, attenuation or insertion loss, and wavelength. The admittance or impedance of source or termination can be measured; so also can transistor and diode characteristics and dielectric constant. It gives the design engineer all the

SPECIFICATIONS

Frequency: 300 MHz to 8.5 GHz. Operates below 300 MHz (where probe travel equals $\frac{1}{2}$ wavelength) if extended with lengths of GR900 air line or with another slotted line in series.

Probe: TRAVEL: 50 cm; scale in cm. SCALE ACCURACY: $\pm(0.1 \text{ mm} + 0.05\%)$. Attached vernier resolution is 0.1 mm and micrometer carriage-drive resolution is 0.002 mm. PICK-UP CONSTANCY (flatness): $\pm 0.5\%$.

SWR: $<1.001 + 0.001 f_{GHz}$ (unknown connector side), calibration data supplied.

Repeatability: Within 0.05% (0.0005 SWR).

Characteristic Impedance: $50 \Omega \pm 0.1\%$. CONTACT RESISTANCE (900-BT connector): $<0.57 \text{ m}\Omega$.

information he needs to evaluate the over-all performance of devices and networks over a wide band.

The outstandingly low SWR of the 900-LB should save users the many hours required to calibrate less accurate instruments.

Equipped with the appropriate GR900 low-SWR adaptor, the 900-LB becomes a type-N slotted line (or BNC, or TNC, etc) whose specifications still exceed those of slotted lines originally equipped with that connector (see curve below).

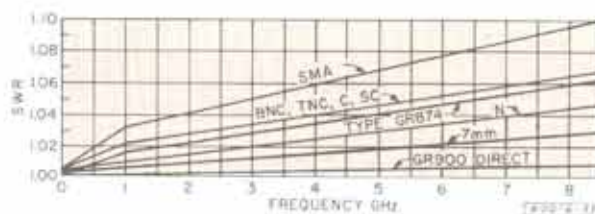

Specified residual SWR of the 900-LB Precision Slotted Line in combination with various GR900® precision adaptors.

Included with the slotted line is a full set of accessories; no additional parts are needed for common measurements, except the generator and detector, which should be selected according to frequency range of interest.

Supplied: Adjustable probe-tuner assembly, rf probe, micrometer carriage drive accurate to 0.01 mm, 900-WN Precision Short-Circuit Termination, 900-WO Precision Open-Circuit Termination, 874-R22A Patch Cord, 874-Q9000L adaptor, 1N21C and 1N23C detector diodes, Smith charts, storage case.

Required: Generator and detector.

Mechanical: DIMENSIONS (wxhxd): 27.5x10x4.75 in. (699x254x121 mm). WEIGHT: 11 lb (5 kg) net, 34 lb (16 kg) shipping.

Description	Catalog Number
900-LB Precision Slotted Line	0900-9651

* Federal stock numbers are listed before the Index.

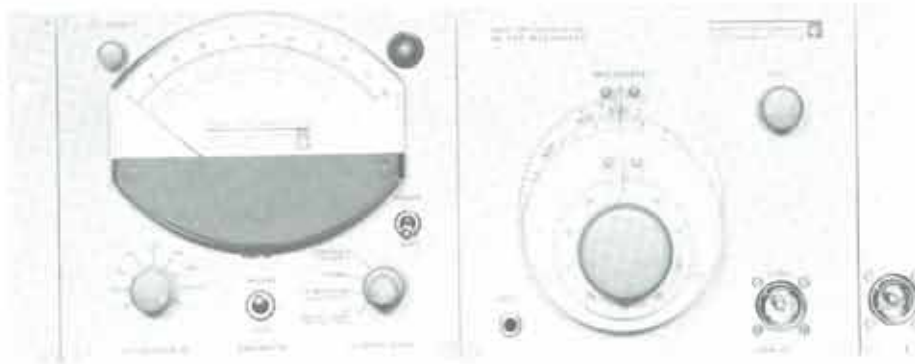

1241 Heterodyne Detector

40 to 2030 MHz

- high sensitivity
- choice of bandwidth
- agc for null detection
- 70-dB calibrated attenuator
- expanded scale

The 1241 is a general-purpose, highly sensitive high-frequency detector system for relative signal-level measurements and for use as a null detector. The excellent shielding makes it suitable for low-level measurements in the presence of high-level external fields.

Gain, loss, signal level The 1241 can be used to measure insertion loss and attenuation, crosstalk in multiterminal devices such as switches, and antenna gain and radiation patterns. It can also be used as a field-strength indicator and as a laboratory high-frequency receiver. Signal levels can be measured over an 80-dB range, even more with the use of external attenuators.

Rf voltmeter When calibrated at one signal level and frequency with the aid of a standard-signal generator, the 1241 can be used as a selective voltmeter, in a 50-ohm system, at that frequency.

Detector This is the recommended null detector for the 1602-B UHF Admittance Meter and is an excellent standing-wave indicator for use with the 874-LBB and 900-LB Slotted Lines. The 1241 is particularly useful for

measurements on nonlinear elements, measurements that require a high degree of harmonic rejection and the use of a low-level test signal. The expanded 1-dB full-scale range (equivalent to 1.12 SWR) makes possible very accurate low-SWR measurements at low signal levels.

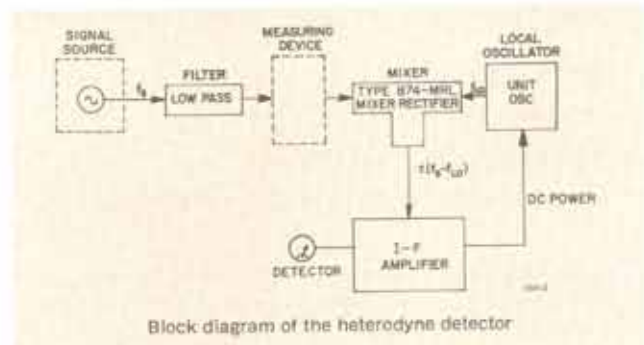

The system Each 1241 consists of an 874-MRAL Mixer, 1236 I-F Amplifier, 874-G10L 10-dB Pad, and 874-EL-L 90° EII, plus an oscillator and filter. For maximum shielding, components are equipped with locking GR874® connectors (which can be used interchangeably with the nonlocking type).

The frequency range can be extended by the use of oscillator harmonics, but with reduced sensitivity and dynamic range. To cover wide frequency ranges economically, it is recommended that you obtain one complete 1241 detector plus the appropriate oscillators and filters for the additional frequency ranges desired.

SPECIFICATIONS

Frequency (in MHz):

Local Oscillator →	1363	1362	1218-BV
Fundamental	40* to 530	190 to 950	870 to 2030
2nd harmonic **	82 to 1030	410 to 1870	1770 to 4030
3rd harmonic **	138 to 1530	630 to 2790	2670 to 6030
4th harmonic **	194 to 2030	850 to 3710	3570 to 8030
Filter Supplied	874-F500L	874-F1000L	874-F2000L

* 40 MHz is the practical low-frequency limit.

** For harmonic operation, the appropriate low-pass filter must be used.

Sensitivity: 4 μ V behind 50 Ω (-100 dBm) typical for 3-dB meter deflection over residual noise reading (narrow bandwidth).

Electrical: MIXER: GR 874-MRAL Mixer. INPUT TERMINAL: Locking GR874 coaxial connector.

Power: 105 to 125 or 210 to 250 V, 50 to 60 Hz, 40 W max.

Mechanical: Bench or rack models. DIMENSIONS (wxhxd): 19x7x8.25 in. (483x178x210 mm) except 1241-9704 and -9705 are 14 in. (386 mm) high. WEIGHT: 1241-9700 and -9701, 20 lb (10 kg) net, 26 lb (12 kg) shipping; 1241-9702 and -9703, 24 lb (11 kg) net, 30 lb (14 kg) shipping; 1241-9704 and -9705, 29 lb (14 kg) net, 35 lb (16 kg) shipping.

Description	Catalog Number
1241 Heterodyne Detector	
40 to 530 MHz, with 1363 oscillator, Bench Model	1241-9700
Rack Model	1241-9701
190 to 950 MHz, with 1362 oscillator, Bench Model	1241-9702
Rack Model	1241-9703
870 to 2030 MHz, with 1218-BV oscillator, Bench Model	1241-9704
Rack Model	1214-9705
1237-A VHF/UHF Preamp , recommended to provide local-oscillator isolation and improved sensitivity	1237-9700

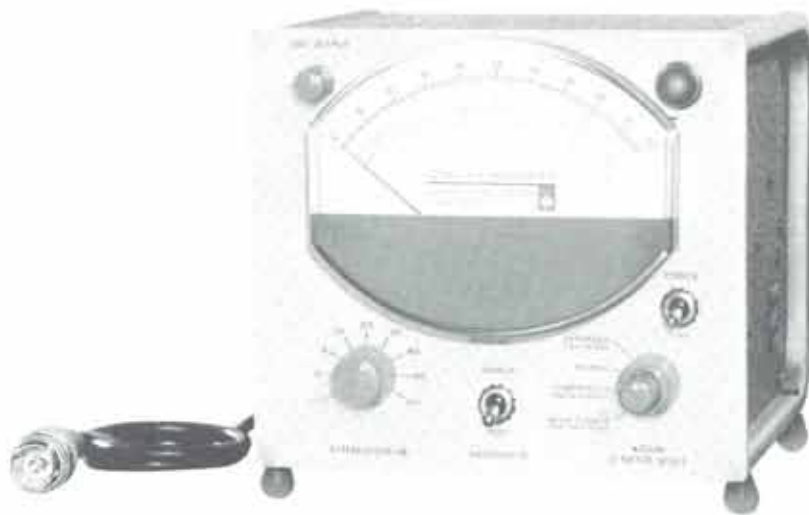

1236 I-F Amplifier

- 30-MHz precision lab receiver
- bandwidths: 0.5 and 4 MHz
- 2-dB noise figure, 3.5- μ V sensitivity
- preamplifier and 70-dB attenuator
- expanded scale

Precision laboratory receiver The 1236 will meet the many critical demands placed upon a precision laboratory receiver. More than an amplifier, it is a complete 30-MHz measuring receiver with preamplifier, wide-range calibrated attenuator, and a large meter with normal, expanded, and compressed scales. The high sensitivity, or low noise figure, with narrow bandwidth will provide good small-signal performance and noise rejection for excellent measurement accuracy. The availability of a wider bandwidth also greatly simplifies use at higher frequencies where sources are generally less stable.

Gain stability during a measurement is ensured by a fully regulated power supply; 10% line-voltage variations change gain less than 0.05 dB. Frequency stability of your local oscillator can be achieved by use of the 30-MHz i-f output of this amplifier to drive an external afc loop.

Precision attenuation measurements You can measure large values of attenuation easily with the 1236, owing to the wide dynamic range of its preamplifier and attenuator. A 1-dB full-scale, expanded meter scale is provided, which facilitates measurement of small values or changes in attenuation. A continuous gain control permits setting initial readings for easy subtraction in substitution measurements.

Precision SWR measurements The 1236 is recommended for the most precise SWR measurements, of both high and low values. The expanded scale is equivalent to 1.12:1 full scale. The high sensitivity of the 1236 permits the SWR of solid-state devices to be measured at signal levels low enough to avoid the effects of device nonlinearity.

As a null detector, the 1236 offers the advantages of its compressed (agc) meter scale for convenience in rapid null balancing and its high sensitivity for sharp nulls

and precise data. It will also find application in noise-figure measurements.

An excellent companion to the 1236 is the 1237 VHF/UHF Preamplifier. Use it as a superheterodyne preamp (ahead of the mixer) for even better sensitivity and measurement accuracy than you get with the 1236 alone.

Precision detector systems The 1236 I-F Amplifier is available in combination with an appropriate local oscillator (power supply for which is built into the 1236), mixer, low-pass filter, an additional preamplifier, and connecting coaxial components to make up complete precision test receivers. These Type 1241 Heterodyne Detectors are available for use in any one of three frequency ranges from 40 to 2030 MHz.

— See *GR Experimenter* for July-Aug 1967.

SPECIFICATIONS

Frequency: CENTER FREQUENCY: 30 MHz. BANDWIDTH: \approx 4 MHz wide band, \approx 0.5 MHz narrow band, selected by panel switch.

Sensitivity: 3.5 μ V narrow band, 9 μ V wide band, open-circuit voltage behind 400 Ω for indication 3 dB above noise level. NOISE FIGURE: 2 dB, typical. PREFERRED SOURCE IMPEDANCE: 400 Ω //7 pF (equivalent of 874-MRAL Mixer).

Meter: SCALE: -2 to 10 dB normal, with \pm 0.2-dB linearity over 0 to 10-dB range; 1 dB full scale expanded (1.12:1 SWR) with \pm 0.03-dB linearity; 40-dB min range, compressed scale.

Gain: ATTENUATOR: 70 dB in 10-dB steps with \pm (0.1 dB + 0.1 dB/10 dB) accuracy at 30 MHz; 10-dB min range continuous gain control.

Outputs: VIDEO (modulation): 1.5 V max behind 600 Ω , 1-MHz bandwidth. I-F: 0.5 V max into 50 Ω . POWER SUPPLY: 150 to 300 V dc adjustable, at 30 mA, regulated; 6.3 V ac at 1 A.

Available: GR 1362, 1363, and 1218-BV as local oscillators, 874-MRAL Mixer, low-pass filters, attenuators, adaptors, 1237 VHF/UHF Preamplifier.

Mechanical: Convertible bench cabinet. DIMENSIONS (wx hxd): 8x7.38x8 in. (213x187x213 mm). WEIGHT: 13 lb (6 kg) net, 15 lb (7 kg) shipping.

Description	Catalog Number
1236-I-F Amplifier	1236-9701

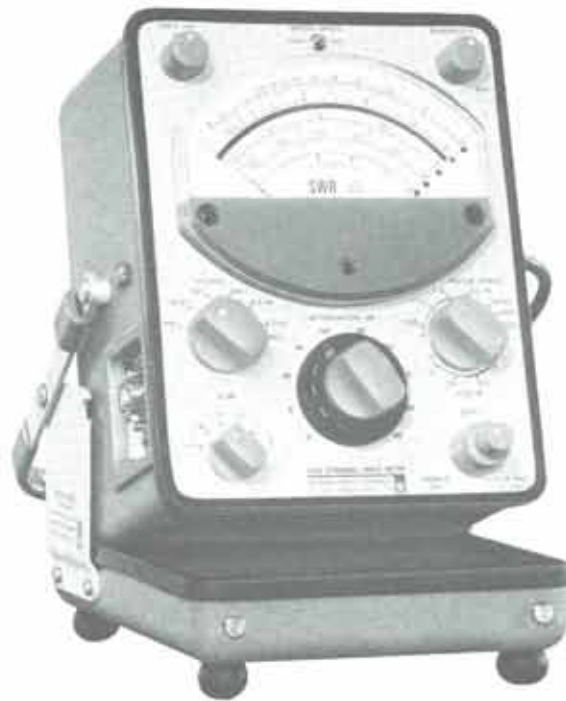

1234 Standing-Wave Meter

- SWR ranges 1.05 to 4, full scale
- large meter with light-keyed scales
- precision attenuators
- highly sensitive

Precise SWR measurements The 1234 Standing-Wave Meter incorporates many features to simplify its primary use in measuring SWR with a slotted line, such as the GR 874-LBB or the 900-LB Precision Slotted Line. Accurate measurements of low voltage SWR are possible with the expanded 1.05 scale on the oversize meter face. Reading the wrong meter scale is virtually impossible, as the correct one is identified automatically by a small light, right at the end of the scale.

You have fingertip control over (1) fine tuning of the 1-kHz amplifier, to permit matching exactly the frequency of the modulating oscillator, (2) bandwidth, for optimizing signal-to-noise ratio without affecting amplifier gain, and (3) meter damping, for the right balance between smoothing and speed of response. These controls, plus the other usual ones, give you adequate means to select appropriate measuring characteristics for a wide variety of important tasks.

Precise attenuation measurements In attenuation measurements, the 1234 also offers many particular advantages. Three precision attenuators have a total range of 70 dB in 1-, 5-, and 10-dB steps. Meter scales and attenuators are calibrated for use with a square-law detector. Readings can be interpolated with extremely high resolution on the 1.6- and 0.45-dB full-scale meter ranges. A special "memory" dial behind the wide-range 5-dB/step attenuator knob permits you to make substitution measurements rapidly, without subtraction, and therefore with little possibility of error.

— See **GR Experimenter** for February 1968.

SPECIFICATIONS

Frequency: 1 kHz, adjustable ± 30 Hz. **BANDWIDTH:** 10 to 100 Hz, adjustable with constant gain.

Input:	Crystal				Bolometer
	Optimum source R	35k Ω	20k Ω	2k Ω	200 Ω
Input Z	1M Ω	350k Ω /80H	35k Ω /8H	3.5k Ω /0.8H	3.5k Ω /0.8H
Sensitivity (fs)	1.2 μ V	1 μ V	0.32 μ V	0.1 μ V	0.1 μ V
Noise*	0.12 μ V	0.12 μ V	0.036 μ V	0.012 μ V	0.012 μ V

* Equivalent input noise level with optimum source resistance and minimum bandwidth.

Meter: SCALES: SWR, 1 to 4, 3.2 to 10, 1 to 1.2, and 1 to 1.05; 0 to 10, 1.6, and 0.45 dB; bolometer current, 0 to 10 mA. **ACCURACY:** $\pm(0.01$ dB + 2% of reading) for 10-dB scale; ± 0.02 dB for 1.6-dB scale; ± 0.007 dB for 0.45-dB scale. **SPEED:** Slow and Fast, switch selected.

Gain: ATTENUATOR: Three separate attenuators; 20 dB in 10-dB steps with ± 0.1 dB/10 dB accuracy, 45 dB in 5-dB steps with ± 0.05 dB/5 dB accuracy (for source R < 1.5 times optimum listed in table) and < 0.1-dB cumulative error, 5 dB in 1-dB steps with ± 0.01 dB/dB accuracy and < 0.03-dB cumulative error. **GAIN CONTROL:** 6-dB range with coarse and fine controls.

Bolometer Bias Current: 4.3 and 8.7 mA, adjustable $\pm 10\%$. Voltage limited for bolometer protection.

Outputs: DC: 1.5 V max behind 1.5 k Ω . AC: 100 mV rms (SWR range 1 to 4), 300 mV rms (SWR 1 to 1.2), and 1 V rms (SWR 1 to 1.05); 500- Ω source impedance; limitation on load, R > 6 k Ω .

Power: 100 to 125 or 200 to 250 V, 50 to 60 Hz, 4 W max; or 22 to 35 V dc at 90 mA from ext battery (use 1538-P3 Battery and Charger).

Mechanical: Flip-Tilt case. **DIMENSIONS (wxhxd):** 8.38x8.75x 11.25 in. (213x222x286 mm). **WEIGHT:** 9 lb (4.1 kg) net, 13 lb (6 kg) shipping.

Description	Catalog Number
1234 Standing-Wave Meter	1234-9701
1538-P3 Battery and Charger	1538-9603

880-DCA Precision Directional Coupler

The 880-DCA is a precision unidirectional 50-ohm coupler with excellent response from 3 GHz to 18 GHz and the highest directivity of any high-frequency or broadband coupler available. Its wide frequency coverage eliminates the need for three, or even four, separate octave couplers with their attendant expense and nuisance in broadband measurements.

Precise tracking of one unit to the next and the lowest SWR of any broadband coupler make the 880-DCA a valuable asset to your reflectometer or network-analysis application. This coupler is also well suited to signal leveling and power or SWR measurements. Altogether, it is a most useful component for your microwave standards lab or new microwave instrumentation.

SPECIFICATIONS

Frequency: 3 to 18 GHz.

Directivity: 34 dB to 8 GHz, 30 dB to 18 GHz; see curve.

SWR (main line): 1.12 to 14 GHz, 1.16 to 18 GHz.

Electrical: IMPEDANCE: 50 Ω . (INPUT: Main line 5 kW/ $\sqrt{10}$ max. Auxiliary line, 2 W max. INSERTION LOSS: 0.4 dB max, including coupled power. COUPLING: 18 \pm 2 dB to 18 GHz; see curve. TRACKING (unit to unit): \pm 0.6 dB.

Mechanical: IEEE 7-mm (APC-7) connectors. DIMENSIONS (wxhxd): 5.75x3.3x1.34 in. (146x87x34 mm). WEIGHT: 0.9 lb (0.4 kg) net, 2 lb (1 kg) shipping.

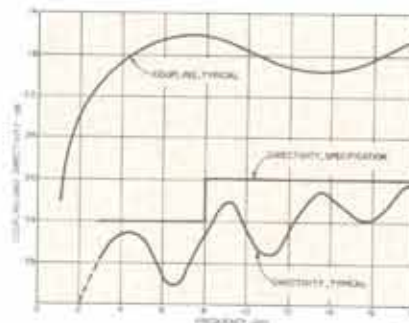
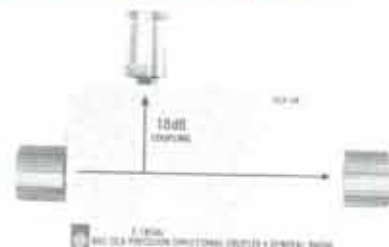

Description

880-DCA Precision Directional Coupler

Catalog Number

0880-9500

1237 VHF/UHF Preamplifier

- 150 kHz to 1 GHz
- 10- to 30-dB gain
- >43-dB isolation

The 1237 is a low-noise, low-level, transistor amplifier for use as a general-purpose amplifier, preamplifier, and isolator, from 150 kHz to 1 GHz. In many applications, it will provide the sensitivity you need for sophisticated measurements with precision (without the need for high test voltages). It is particularly useful in a heterodyne detector system, used with a bridge. As a component in a small-signal measurement system, the 1237 also replaces a local-oscillator trap or isolator that might otherwise be needed to isolate the receiver local-oscillator signal from the measurement instrument, bridge, or device under test. The reverse attenuation of the 1237 conveniently provides such isolation. A 30-MHz notch filter in this preamplifier effectively blocks noise at that frequency, noise that might otherwise pass through a mixer into a following i-f amplifier tuned to 30 MHz, such as the GR 1236, and reduce its sensitivity.

The signal detection system that employs a modulated signal, envelope detector, and tuned audio amplifier is usually not so sensitive as a heterodyne detector. However, with the broadband gain of one or two 1237's added ahead of the envelope detector, the sensitivity of this method approaches that of a heterodyne detector and gives the benefits of wide-band operation without need for a local oscillator.

The 1237 VHF/UHF Preamplifier consists of a three-stage solid-state amplifier, a 30-MHz stop-band filter, and an ac power supply. It will operate from a 9-V external battery for field use or for isolation from the power line.

—See **GR Experimenter** for March/April 1969.



SPECIFICATIONS

Frequency: 150 kHz to 1 GHz.

Gain: > 10 dB; see curve.

Electrical: REVERSE ATTENUATION: > 43 dB to 700 MHz. NOISE: See curve.

Power: 100 to 125 or 200 to 250 V, 50 to 400 Hz, 1.5 W; or 9 V dc, 18 mA.

Mechanical: Locking GR874[®] connectors for input and output. DIMENSIONS (wxhxd): 6.25x3.69x2.5 in. (159x94x64 mm). WEIGHT: 1.5 lb (0.7 kg) net, 3 lb (1.4 kg) shipping.

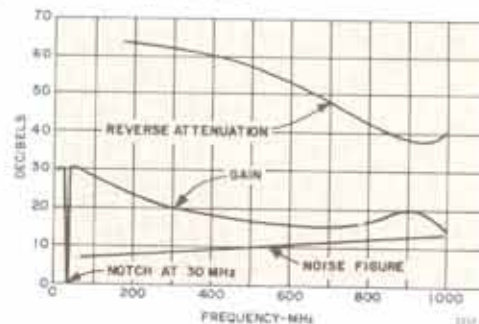

Typical noise figure, gain, and reverse attenuation characteristics of the VHF/UHF preamplifier.

1237 VHF/UHF Preamplifier

1237-9700

High-Frequency Signal Sources

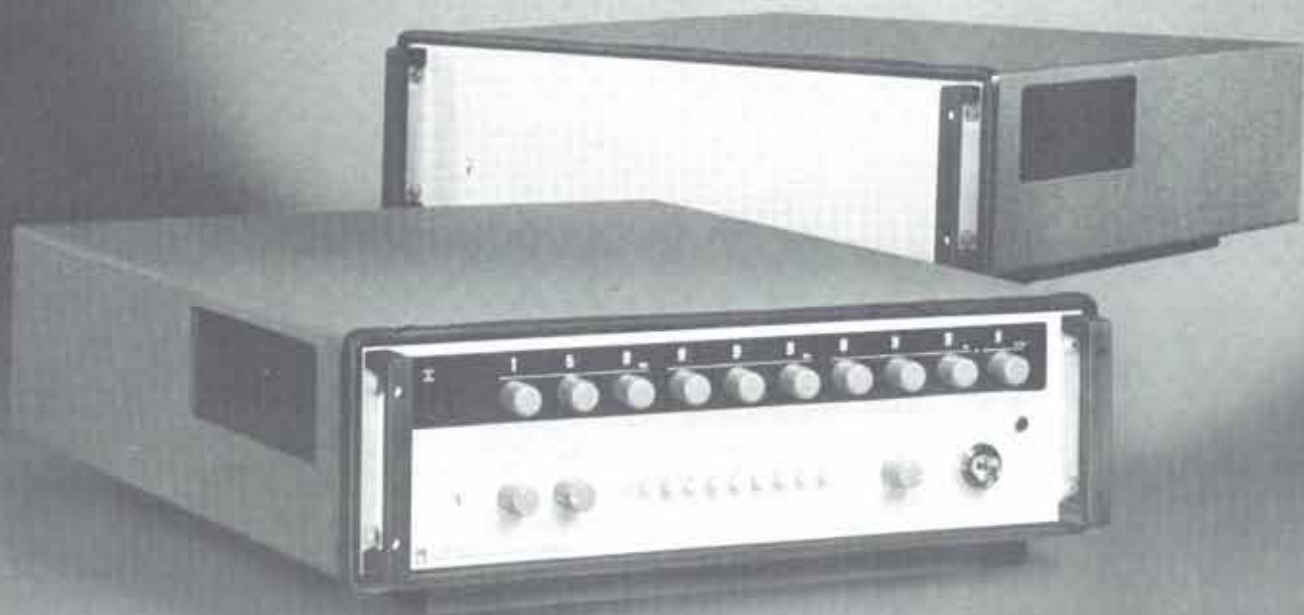
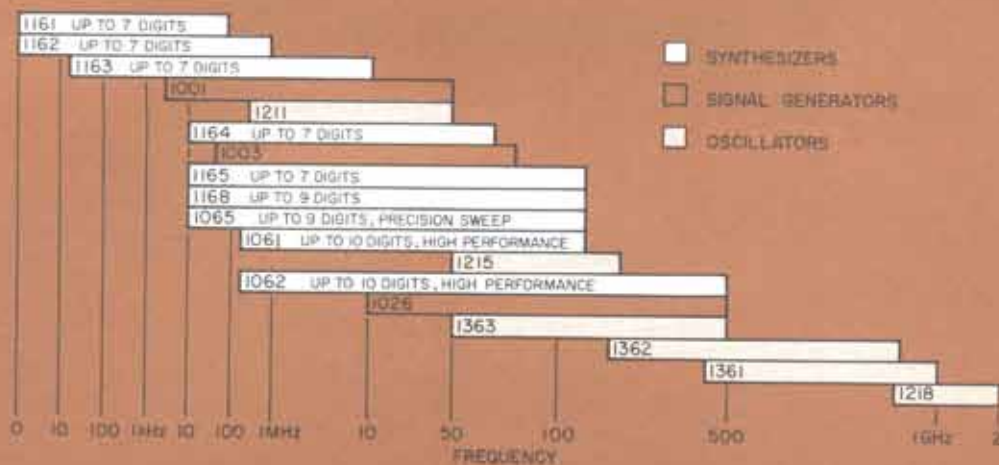



Frequency Synthesizers

dc to 500 MHz

Frequency synthesizers combine the features of a frequency standard with those of a tunable oscillator to provide a highly accurate, yet tunable, output. In addition, most synthesizers provide digital frequency selection for precise resettability and a supremely clean output. Use them for the most reliable and repeatable measurements.

General Radio synthesizers also offer add-on design so you need purchase only the capability you require. They also include provision to be externally locked to, or driven by, an external frequency standard for unlimited accuracy and repeatability from one unit to the next. All can be remotely programmed for systems use and most offer a search-sweep mode; one even provides you with a built-in automatic sweep.

The GR selection of synthesizers covers the frequency range from dc to 500 MHz with resolutions as fine as 0.0001 Hz. Choose among nine basic types and over 386 variations plus models specially tailored to your specific requirements. If you don't see exactly what you need on the following pages, ask.

Applications for frequency synthesizers include those normally associated with signal generators and frequency standards. Synthesizers are also uniquely qualified for a variety of other uses:

- For measurements on sharply tuned devices: The stability and resolution provided by a synthesizer may be absolutely necessary. A crystal filter with a Q of 10,000, for example, has half-power points only 50 ppm away from the resonant frequency.
- For precise frequency determination of nuclear magnetic resonance and electron paramagnetic resonance or for heterodyne frequency measurements, where you need answers continuously and without any ± 1 -count uncertainty.
- For the study of lock range, capture range, and loop stability of active bandpass filters found in frequency multipliers and phase-locked telemetry loops.
- For the control of communications transmitters and receivers or for the measurements of drift between a fixed-frequency standard and an unknown frequency.

A natural companion to the synthesizer is a programmable attenuator. Refer to the GR 1452, for accuracy in level control, over 80 dB, in 1-dB steps.



Oscillators

500 kHz to 2 GHz

General Radio offers a series of seven low-cost, compact oscillators that provide continuous coverage from 500 kHz to 2 GHz, with single-dial control and outputs in the order of several hundred milliwatts. By appropriate

choice of power supply, you can secure from these oscillators (1) maximum power, (2) optimum frequency stability with minimum residual fm and a-m, (3) pulse and square wave modulated output, (4) amplitude-regulated output for sweeping applications. Use them as local oscillators in your heterodyne detector systems.



Standard-Signal Generators

5 kHz to 500 MHz

A standard-signal generator is a source of alternating-current energy of accurately known characteristics. The carrier, or center, frequency is indicated by a dial setting, the output voltage by a meter reading and associated attenuator setting, and the modulation by a meter reading set by appropriate control knobs. Common types of modulation signals are sine-wave, square-wave, and pulse; the output signal may be either frequency- or amplitude-modulated by these signals. When the frequency-modulation system produces a considerable excursion in frequency at a relatively low-cyclical rate, the instrument is known as a sweep-frequency generator and is particularly useful for automatic data display. Standard-signal generators are used for testing radio receivers, as voltage standards over the range from fractional microvolts to about a volt, and generally as power sources in measurement of gain, bandwidth, sig-

nal-to-noise ratio, standing-wave ratio, and other circuit properties.

For use as a standard-signal generator, the oscillator must be stable, have reasonably constant output over any one frequency range, have good waveform, and have no appreciable hum or noise modulation. Careful over-all shielding of the generator is essential in order to minimize stray fields.

The three General Radio amplitude-modulated standard-signal generators are general-purpose, wide-tuning-range instruments covering the range from 5 kHz to 500 MHz. Amplitude modulation is provided from an internal, fixed-frequency, sine-wave generator or from an external audio-frequency source. In addition to a choice of frequency ranges, the GR generators offer a wide selection of performance features: high output, excellent shielding for accurate low-level output, leveling, modulation versatility, and unusually good stability. Each instrument offers a well balanced combination of features that allow the user to make fast and accurate measurements over a wide range of test conditions.

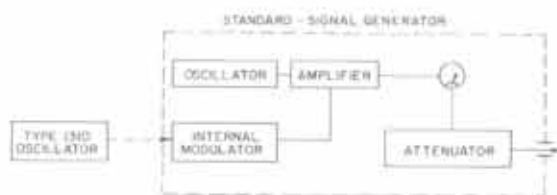

Elements of a standard-signal generator.

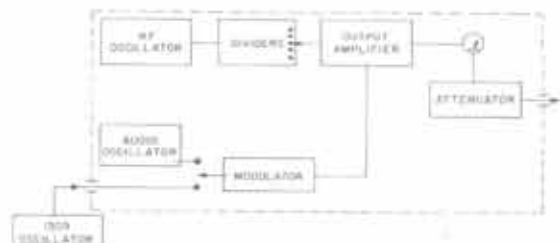

High-stability standard-signal generator.

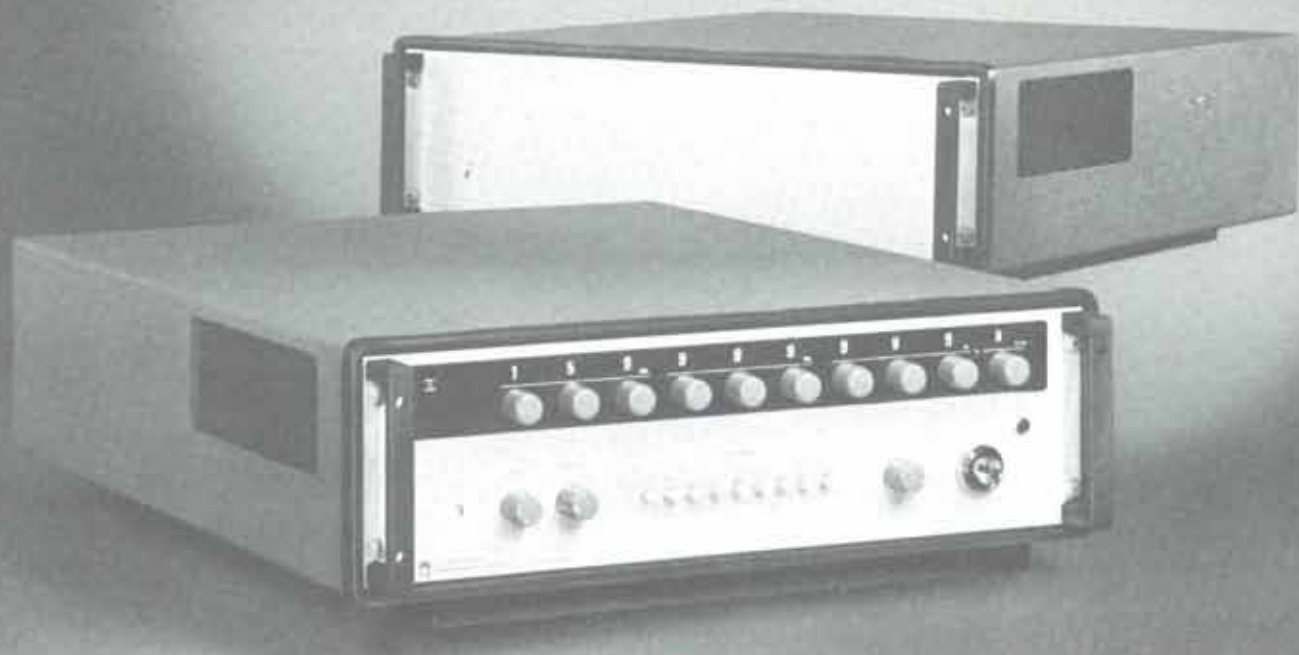

1061 Frequency Synthesizer

- to 160 MHz
- spurious > 80-dB down
- phase noise > 63-dB down
- 100- μ s switching speed
- +20-dBm leveled output
- your choice of resolution — 10 kHz to 0.1 Hz
- search sweep
- programmable frequency and amplitude
- frequency- and amplitude-modulation capability

Exceptional spectral purity The 1061 provides a signal output with exceptional spectral purity for any synthesizer application — non-harmonics are down more than 80 dB below the signal, harmonics are down more than 27 dB and phase noise is down at least 63 dB (typically 65 to 70 dB)! Equally important is the wide output range of 0 dBm to +20 dBm (224 mV to 2.24 V) into 50 Ω . The level can be set by an external dc signal or, with the local-control option, by a panel control.

Search-sweep standard One of the more useful features of the 1061 is its built-in search-sweep capability. Any decade, up to 1 MHz, can be electrically converted into a continuously adjustable decade, to extend the resolution two decades beyond its step-digit resolution (a synthesizer with a nominal resolution of 100 Hz actually has 1-Hz resolution via the search-sweep dial).

The decade to be replaced is selected by an external control input or, in models with the local-control option, by panel pushbuttons. This capability provides the synthesizer with the convenience of a signal generator for resonance or bandpass studies and also makes possible sweep-frequency measurements because the search-sweep dial can be remotely controlled by a dc signal or sawtooth waveform. Deviation rates up to 20 kHz can be used even in low-distortion fm applications.

Built-in remote programmability In the 1061, rapid remote programmability is standard — less than 100 μ s

per step, set by standard 8-4-2-1 BCD signals. The basic models have no front-panel controls, for system economy and a neat appearance and to reduce the possibility of accidental control misadjustments. A local-control panel is available as a standard option.

Highly flexible design A wide choice of options combines the benefits of custom design with the economy of off-the-shelf units. Standard resolution is 10 kHz (5 digits) but is expandable to 0.1 Hz (10 digits) in 1-digit increments.

The synthesizer also offers you a choice of a moderate-precision internal oscillator, a high-precision oscillator, or no internal oscillator at all (for applications where an external frequency standard is available to drive the synthesizer). In applications where two or more synthesizers are to be used, only one need be driven by the external standard (or internal oscillator) because the output from one synthesizer can be used to drive the next. This is both an economy in equipping a large facility and a means of assuring frequency coherence.

SPECIFICATIONS

Fixed Frequency: 400 kHz to 159.99 MHz (and dc to 10 MHz) in 10-kHz steps with 100-Hz search-sweep setability. Finer steps optional, the finest being 0.1-Hz steps with 0.001-Hz search-sweep setability. **LOCAL CONTROL (Option 1):** Set by in-line-readout panel switches or external remote-control signals; control transferred by single panel control. **REMOTE CONTROL:** Set by 8-4-2-1 external signals; logic "1" is 0 to 0.5 V at 3 mA, logic "0" is +5 V at 0 mA. Programming time < 100 μ s per step except with economy resolution options (4F or 4G), where it is ~ 5 ms for steps below 10 kHz.

Search-Sweep and Frequency Modulation — (not available with economy resolution options 4F and 4G): **SWEEP WIDTH:** Up to 11 MHz. Any decade, with 1-MHz steps or less, can be replaced by a continuous control with a range of -1 to $+10 \times$ one step of the decade being replaced, with a setability of 1/100 of one step. **LOCAL CONTROL (optional):** Digit to be replaced is chosen by panel pushbuttons or external signal; frequency is set by -1 to $+10$ multiplier plus continuous vernier or by external signal. **REMOTE CONTROL:** Digit to be

replaced is chosen by logic signal; frequency is set by +0.5V/step (-0.5 to +5.0 V) dc signal with nonlinearity of ± 0.2 step max. SWEEP (FM) RATE: Dc to 20 kHz, -3 dB. DEVIATION pk-pk: Same as sweep width. HARMONIC DISTORTION: $< 3\%$ for all deviations within range of decade selected. STABILITY: $\pm 2 \times 10^{-4}$ step, $\pm 1 \times 10^{-4}$ step/min, $\pm 1 \times 10^{-3}$ step/h. AMPLITUDE MODULATION: Dc to 1 kHz at 90% modulation, dc to 5 kHz at 30% modulation, dc to 10 kHz at 15% modulation; with 5% distortion. Control via remote-control Signal Output (see below), achieved by externally summing an a-m rate source with a dc voltage to set average value of rf composite signal.

Signal Output: 224 mV to 2.24 V rms (0 to +20 dBm into 50 Ω) from 50- Ω source, available at rear GR874[®] connector (optionally on front panel). LOCAL CONTROL (optional): Set by panel control with ± 1.5 -dB accuracy or by external remote-control signal. REMOTE CONTROL: Set by external dc signal of 2 X desired rms output voltage, into 100 k Ω applied to rear BNC connector. Programming time $< 100 \mu\text{s}$, to desired level with ± 1 dB.

	400 kHz	2 MHz	160 MHz
Output Level (freq response) full output	± 1 dB		± 0.3 dB
Harmonics, 50- Ω load		< -27 dB	
Discrete Non-Harmonics		< -80 dB	
Noise Modulation phase, rms*	< -60 dB, re 1 rad, $\pm(0.5 \text{ Hz to } 15 \text{ kHz})$		
amplitude, rms	< -75 dB, re 100% carrier, $\pm(0.5 \text{ Hz to } 15 \text{ kHz})$		

* Also see curve.

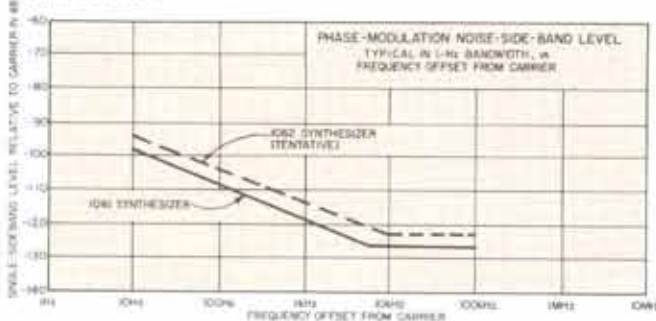

Auxiliary Outputs: Low-level output of dc to 10 MHz at 125 mV $\pm 10\%$ rms, with ± 0.25 -dB flatness, < -38 dB distortion, available at rear BNC connector. 10 MHz at 500 mV $\pm 20\%$ into 50 Ω , which can be used to drive another synthesizer, 1 MHz at 2.5 V pk-pk into 1 k Ω , 42 MHz at 165 mV $\pm 20\%$ into 50 Ω , all available at rear BNC connectors.

Phase Modulation (optional): Output can be phase modulated ± 3 rad from dc to 300 kHz, ± 1 rad at 1-MHz modulation frequency, by external signal of 1 V/rad at dc, flat within 2 dB to 300 kHz, into 7.5 k Ω , applied to rear BNC connector.

Accuracy of Fixed Frequency: Equal to that of drive source. Drive source can be internal oscillator or external drive.

Internal Oscillator (optional): MODERATE STABILITY: 10-MHz crystal oscillator. Adjustment range $> 5 \times 10^{-4}$ by manual trimmer or $> 5 \times 10^{-4}$ by +6- to +9-V external dc signal. Stability is $2 \times 10^{-7}/^\circ\text{C}$ from +20 to +50 $^\circ\text{C}$, $2 \times 10^{-4}/\text{mo}$. HIGH STABILITY: 10-MHz crystal oscillator in proportional-control oven. Adjustment range, $> 4 \times 10^{-4}$ by manual trimmer or $> 5 \times 10^{-4}$ by +6- to +9-V external dc signal. Stability, $< 2 \times 10^{-7}/^\circ\text{C}$ from 0 to +50 $^\circ\text{C}$. Drift, $\pm 1 \times 10^{-4}/\text{wk}$, $\approx 1 \times 10^{-3}/\text{day}$ after 1 month of continuous operation, $< 2 \times 10^{-8}$ with $\pm 10\%$ line-voltage variation, restabilizes within 2 h after power interruption. Connector provided on rear for battery to maintain oscillator during power interruption.

External Drive (required on models without internal oscillator): 5 or 10 MHz, 130 mV to 2.5 V rms into 500 Ω applied to rear BNC connector.

Environment: TEMPERATURE: 0 to +50 $^\circ\text{C}$ operating.

Supplied: Power cord, coaxial patch cord with GR874 connectors, 50-pin plug to mate with rear connector.

Available: GR874 adaptors, 1452 Programmable Attenuator.

Power: 90 to 110, 104 to 127, 180 to 220, 194 to 236, or 207 to 253 V; 48 to 66 Hz (45 to 48 Hz with high-line limit decreased 5%, 360 to 440 Hz with low-line limit increased 5%); 70 W max. Connection provided for 15- to 18-V, 200-mA, dc source to maintain high-stability oscillator during power interruption.

Mechanical: Bench or rack models. DIMENSIONS (wxhxd): Bench, 19.75x6.9x24.88 in. (502x176x632 mm); rack, 19x5.22x22.88 in. (483x133x569 mm). WEIGHT: Bench, 58 lb (27 kg) net, 69 lb (32 kg) shipping; rack, 50 lb (23 kg) net, 61 lb (28 kg) shipping.

Description	Catalog Number
1061 Frequency Synthesizer, 400 kHz to 160 MHz with 10-kHz resolution and 100-Hz search settability, remote control, and external drive only Bench Model Rack Model	
Select following options, if desired	
OP1 Local Control Panel	
OP2A Moderate-Stability Internal Oscillator	
OP2B High-Stability Internal Oscillator	
OP3 Phase Modulation	
OP4A 1-kHz digit resolution (10-Hz search)	
OP4B 100-Hz digit resolution (1-Hz search)	
OP4C 10-Hz digit resolution (0.1-Hz search)	
OP4D 1-Hz digit resolution (0.01-Hz search)	
OP4E 0.1-Hz digit resolution (0.001-Hz search)	
OP4F 100-Hz digit resolution (economy, 5-ms switching, no search-sweep)	
OP4G 1-Hz digit resolution (economy, 5-ms switching, no search-sweep)	
Available for customer installation Digit Insertion Kit*	1169-9600

* Additional digits of resolution may be added to any synthesizer equipped with options 4A through 4D.
U.S. Patent Number 3,509,483.

1062 Frequency Synthesizer

- to 500 MHz
- spurious > 80 -dB down
- phase noise > 60 -dB down
- 100- μs switching speed
- +13 dBm leveled output
- 10-kHz to 0.1-Hz resolution
- search-sweep
- programmable frequency and amplitude
- frequency and phase-modulation capability



This synthesizer is similar to the 1061 except its performance extends to 500 MHz! Detailed information is available on request.



1165 and 1168 Frequency Synthesizers

- to 160 MHz
- 1-V rms output
- 1-kHz to 1-Hz resolution
- programmable frequency and amplitude

A wide choice These synthesizers offer a variety of capabilities to suit widely differing applications. For example, if 6-digit resolution is adequate for your use, the basic 1165 with 1-kHz resolution is a natural choice. For higher resolutions, the 1165 is offered with 7 digits (100-Hz resolution) and the 1168 is available with 8 or 9 digits (10-Hz or 1-Hz resolution).

Remote control — a built-in advantage Ordinarily, easily read in-line panel controls provide direct decimal setting of the output frequency. However, frequency selection can also be transferred by a single control to external BCD signals for rapid remote programming (200

μs to 5 ms for the basic models, depending on the step). The 1165 and 1168 provide an output level continuously adjustable from 100 mV to 1 V. This also can be remotely programmed over the full range.

Basic economy The basic slave versions are an economical choice for applications where a precision 5-MHz or 10-MHz source is available. These versions contain no internal oscillator and must be driven by an external source such as a standard-frequency oscillator, the 10-MHz reference output of a version with an oscillator, or the 10-MHz reference output of a driven slave version. Any number of these synthesizers can be cascaded and thus offer the capability of multiple, *coherent*, frequencies for an entire system or array of systems.

Where independent operation is desired, a master version is available for both the 1165 and 1168. The master version includes a stable internal oscillator that can be operated independently, locked to an external standard, or replaced by one.

SPECIFICATIONS

	GR 1165, 6 or 7 digits	GR 1168, 8 or 9 digits																																
Frequency:	10 kHz to 159.999 MHz (optional to 159.9999 MHz), 1-kHz steps, optional to 100-Hz steps LOCAL CONTROL: Set by in-line readout panel switches or external remote-control signal; transferred by single panel control. REMOTE CONTROL: Set by 4-line 8-4-2-1 external signal; logic "0" is +5 V at 0 mA, logic "1" is < +0.5 V at 3 mA. Programming time, < 200 μs for steps ≥ 100 kHz, < 5 ms for remainder (with added-resolution option for 1165: < 50 ms for steps ≤ 10 kHz, 1168 < 50 ms for steps ≤ 100 Hz)	10 kHz to 159.99999 MHz (optional to 159.999999 MHz), 10-Hz steps, optional to 1-Hz steps																																
Signal Output:	100 mV to 1 V rms into 50 Ω from 50-Ω source; GR874® connector mounts on front or rear panel. LOCAL CONTROL: Set by calibrated control or by external remote control signal. REMOTE CONTROL: Set by external dc signal of 4x desired rms output voltage, into 100 kΩ, applied to rear BNC connector. Programming time, 10 ms to within 1 dB of desired output; control accuracy ±1 dB typical, ±2 dB max, including leveling errors.	100 mV to 1 V rms into 50 Ω from 50-Ω source; GR874® connector mounts on front or rear panel.																																
	OUTPUT LEVEL (frequency response), full output 1/10 output HARMONICS output into 50-Ω load DISCRETE NON-HARMONICS NOISE MODULATION phase, rms (see curve) amplitude, rms	<table border="1"> <thead> <tr> <th>10 kHz</th> <th>100 kHz</th> <th>110 MHz</th> <th>160 MHz</th> </tr> </thead> <tbody> <tr> <td>-0, +1 dB</td> <td></td> <td>±0.3 dB</td> <td></td> </tr> <tr> <td>-1, +2 dB</td> <td></td> <td>±1.3 dB (±1 dB typical)</td> <td></td> </tr> <tr> <td>< -25 dB</td> <td></td> <td>< -30 dB</td> <td></td> </tr> <tr> <td>< -60 dB (-70 dB typical)</td> <td></td> <td>< -55 dB (-60 dB typical)</td> <td></td> </tr> <tr> <td>< -53 dB (< -51 dB for 1165 with 100-Hz resolution)</td> <td></td> <td></td> <td></td> </tr> <tr> <td></td> <td></td> <td>re 1 rad, 0.5 Hz to 15 kHz</td> <td></td> </tr> <tr> <td></td> <td></td> <td>< -63 dB, re 100% carrier, 0.5 Hz to 15 kHz.</td> <td></td> </tr> </tbody> </table>	10 kHz	100 kHz	110 MHz	160 MHz	-0, +1 dB		±0.3 dB		-1, +2 dB		±1.3 dB (±1 dB typical)		< -25 dB		< -30 dB		< -60 dB (-70 dB typical)		< -55 dB (-60 dB typical)		< -53 dB (< -51 dB for 1165 with 100-Hz resolution)						re 1 rad, 0.5 Hz to 15 kHz				< -63 dB, re 100% carrier, 0.5 Hz to 15 kHz.	
10 kHz	100 kHz	110 MHz	160 MHz																															
-0, +1 dB		±0.3 dB																																
-1, +2 dB		±1.3 dB (±1 dB typical)																																
< -25 dB		< -30 dB																																
< -60 dB (-70 dB typical)		< -55 dB (-60 dB typical)																																
< -53 dB (< -51 dB for 1165 with 100-Hz resolution)																																		
		re 1 rad, 0.5 Hz to 15 kHz																																
		< -63 dB, re 100% carrier, 0.5 Hz to 15 kHz.																																
Auxiliary Outputs:	-12 V at 50 mA, +5.6 V at 50 mA, +18 V at 100 mA; available at rear tip jacks. 10 MHz at 500 ±50 mV rms into 50 Ω, 1 MHz at > 2 V pk-pk into 10 kΩ; available at rear BNC connectors.																																	

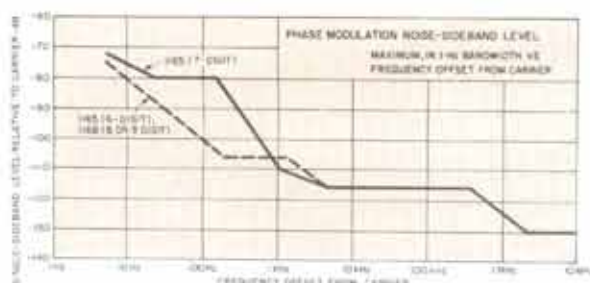

Phase Modulation: Output can be phase modulated ± 3 rad from dc to 300 kHz ± 1 rad at 1-MHz modulation frequency, by external signal of 1 V/rad at dc, flat within 2 dB to 300 kHz, into 7.5 k Ω , applied to rear BNC connector.

Frequency Modulation: (Via phase modulation, see above). **DEVIATION pk-pk:** Same as sweep width above. External 0-to-15 kHz signal of 2.5 V pk, applied to panel BNC connector or rear connector, produces full selected deviation, flat ± 1 dB. **HARMONIC DISTORTION:** $< 1\%$ for fm < 1 kHz, $< 3\%$ for modulation frequencies ≤ 15 kHz, with sweep-width range set to 1 or 10 kHz. **HUM AND NOISE:** ≥ 60 dB below max deviation at any sweep-multiplier setting.

Accuracy of Fixed Frequency: Equal to that of drive source. Drive source can be internal oscillator (master versions), external lock (with internal oscillator only), or external drive.

Internal Oscillator (master versions): 10-MHz precision oscillator in proportional-control oven. Adjustment range, $\pm 2 \times 10^{-4}$ by manual trimmer. Stability, $< 2 \times 10^{-7}/^{\circ}\text{C}$ from 0 to $+50^{\circ}\text{C}$ when operated continuously. Drift, $\pm 1 \times 10^{-4}/\text{wk}$, $= 1 \times 10^{-4}/\text{day}$ after 1-month continuous operation. 10% line-voltage variation causes $< 2 \times 10^{-8}$ change, restabilizes to within $\pm 1 \times 10^{-4}$ two hours after power interruption. Connection provided on rear for battery to maintain oscillator during power interruption.

External Lock (master versions): Internal oscillator can be locked to external signal within $\pm 4 \times 10^{-4}$ of 5 MHz or integer submultiple down to 100 kHz, 100 mV rms min into 1 k Ω to

3 V max into 50 Ω , at rear BNC connector. After power interruption to oscillator, 30 minutes required for oscillator to stabilize within lock range. Panel lamp warns of lock failure.

External Drive (required for slave versions): 5 or 10 MHz at 130 mV min, 3 V max into 50 Ω at rear BNC connector.

Environment: TEMPERATURE: 0 to $+50^{\circ}\text{C}$ operating, -40 to $+75^{\circ}\text{C}$ storage. HUMIDITY: 95% RH and $+40^{\circ}\text{C}$. **BENCH HANDLING:** 4 in. or 45° (MIL 810A-VI).

Supplied: Power cord, coaxial patch cord with GR874 connectors, 50-pin plug to mate with rear connectors.

Power: 100 to 125 or 200 to 250 V, 50 to 60 Hz; 105 to 125 or 210 to 250 V, 50 to 400 Hz; 50 W max. Connection provided for 15- to 18-V, 200-mA, dc source to maintain oscillator during power interruption.

Mechanical: Bench or rack models. 1165: DIMENSIONS (wx hxd): Bench, 19.75x5.15x20.88 in. (502x131x530 mm); rack 19x3.5x18.38 in. (483x89x466 mm). WEIGHT: Bench, 43 lb (20 kg) net, 52 lb (24 kg) shipping; rack, 36 lb (17 kg) net, 45 lb (21 kg) shipping. 1168: DIMENSIONS (wx hxd): Bench, 19.75x5.15x22.88 in. (502x131x581 mm); rack, 19x3.5x20.38 in. (483x89x517 mm). WEIGHT: Bench, 48 lb (22 kg) net, 59 lb (27 kg) shipping; rack, 41 lb (19 kg) net, 52 lb (24 kg) shipping.

Description	Catalog Number
1165 Frequency Synthesizer	
6-digit Master Version, Bench Model	1165-9710
6-digit Master Version, Rack Model	1165-9711
6-digit Slave Version, Bench Model	1165-9712
6-digit Slave Version, Rack Model	1165-9713
7-digit Master Version, Bench Model	1165-9720
7-digit Master Version, Rack Model	1165-9721
7-digit Slave Version, Bench Model	1165-9722
7-digit Slave Version, Rack Model	1165-9723
1168 Frequency Synthesizer	
8-digit Master Version, Bench Model	1168-9700
8-digit Master Version, Rack Model	1168-9701
8-digit Slave Version, Bench Model	1168-9702
8-digit Slave Version, Rack Model	1168-9703
9-digit Master Version, Bench Model	1168-9720
9-digit Master Version, Rack Model	1168-9721
9-digit Slave Version, Bench Model	1168-9722
9-digit Slave Version, Rack Model	1168-9723



1065 Sweeping Frequency Synthesizer

- to 160 MHz
- sweep frequencies
- 1-V rms output
- 1-Hz resolution
- programmable frequency and amplitude

Sweep frequencies The 1065 combines the accuracy, stability, and full 9-digit resolution of the 1168 with the versatility of a precision sweep-frequency generator. Any calibrated sweep width from 5 Hz to 2 MHz can be obtained, centered on any frequency selected by the normal

digital frequency controls with linearity better than 1%. Wide-band sweeps up to the full frequency range of 160 MHz are provided. The 1065 can also be frequency modulated with a peak-to-peak Δf of 5 Hz to 160 MHz by external signals with rates up to 15 kHz. All sweep-width and sweep-speed controls are remotely programmable.

Description	Catalog Number
1065 Sweeping Frequency Synthesizer, 9-digits, includes internal oscillator	
Bench Model	1065-9720
Rack Model	1065-9721



Frequency Synthesis to 70 MHz

1161, 1162, 1163, and 1164 Frequency Synthesizers

- to 70 MHz
- to 7 digits plus search sweep
- programmable frequency selection
- 80 models plus tailored specials

Economical variety This is one of the most economical families of synthesizers available today, thanks to its modular construction. You pay only for the capability you need. This same benefit also permits maximum flexibility to meet nearly any application, large or small, simple or complex. Over 80 models are stocked, with four basic upper-frequency limits of 100 kHz, 1 MHz, 12 MHz, and 70 MHz. In addition, each type is available with any number of digits from 3 to 7 and each can be ordered with or without "search-sweep" or remote programmability.

Search-sweep The optional search-sweep feature of these synthesizers allows any decade, up to 1 MHz, to be replaced by a continuously adjustable decade, controllable from -1 to $+10$ times one step of the decade being replaced. The added resolution is normally 100 times finer than that of the replaced decade; thus the resolution of a 7-digit 100-kHz model with the search-sweep option is 0.0001 Hz (rather than the normal 0.01 Hz). When the search-sweep dial is calibrated by means of an internal calibrating mixer, the resolution is greater still — as fine as 10^{-6} Hz for the same 100-kHz synthesizer. You select the decade to be replaced by simply pushing a button on the front panel.

An added advantage of the search-sweep mode is the fact it can also be externally controlled with an analog signal. Since any decade of 1 MHz or below can be re-

placed by the search-sweep dial, with an external sawtooth waveform (such as available from many oscilloscopes) you can convert the synthesizer for sweep-frequency use from 0 to 1 MHz (100 kHz for the GR 1161).

Remote control For automated measurements and computer control, these synthesizers can be ordered with remote programmability — each digit can be set by an external signal in less than 200 μ s. Together with the external control of search-sweep, these programmable digits make the synthesizer a boon to fully automatic testing of a host of frequency-sensitive instruments and components.

SPECIFICATIONS

Accuracy of Fixed Frequency: Equal to that of drive source. Drive source can be internal oscillator or external lock.

Internal Oscillator: 5-MHz crystal oscillator. Adjustment range ± 7 to 10×10^{-6} by panel trimmer. Stability $< 2 \times 10^{-7}/^{\circ}\text{C}$ from $+20$ to $+50^{\circ}\text{C}$.

External Lock: Internal oscillator can be locked to external signal of 5 MHz or integer submultiple down to 100 kHz, 250 mV rms min into 1 k Ω to 5 V rms max into 50 Ω , applied to rear GR874* connector.

Environment: TEMPERATURE: 0 to $+50^{\circ}\text{C}$ operating.

Supplied: Power cord, coaxial patch cord with GR874 connectors, bridging unit for maintenance ease.

Power: 100 to 125 or 200 to 250 V, 50 to 400 Hz, 55 W (60 W for 1164); or 20 to 28 V dc at 1.8 A.

Mechanical: Rack-bench cabinet. **1161, 1162, 1163:** DIMENSIONS (wxhxd): Bench, 19x5.5x15.5 in. (483x140x394 mm); rack, 19x5.25x13 in. (483x133x330 mm). WEIGHT: 38 lb (18 kg) net, 45 lb (21 kg) shipping. **1164:** DIMENSIONS (wxhxd): Bench, 19x5.25x19.25 in. (483x133x489 mm); rack, 19x5.25x17 in. (483x133x432 mm). WEIGHT: 45 lb (21 kg) net, 52 lb (24 kg) shipping.

GR 1161 0 to 100 kHz Fixed Frequency: 0 to 100 kHz, 100-Hz steps (optional to 0.01-Hz steps and 0.001-Hz search-sweep settability). LOCAL CONTROL: Set by in-line-readout panel switches. REMOTE CONTROL (optional): set by 10-line contact closures (4-line B-4-2-1 available). Programming time, 200 us to establish new frequency.	GR 1162 0 to 1 MHz 0 to 1 MHz, 1-kHz steps (optional to 0.1-Hz steps and 0.001-Hz search-sweep settability).	GR 1163 30 Hz to 12 MHz 30 Hz to 12 MHz, 10-kHz steps (optional to 1-Hz steps and 0.01-Hz search-sweep settability).	GR 1164 10 kHz to 70 MHz 10 kHz to 70 MHz, 100-kHz steps (optional to 10-Hz steps and 0.1-Hz search-sweep settability).
---	--	--	---

Search-Sweep and Frequency Modulation (optional)
 SWEEP WIDTH: To 100 kHz. | SWEEP WIDTH: To 1.1 MHz. | SWEEP WIDTH: To 1.1 MHz. | SWEEP WIDTH: To 1.1 MHz.
 Any decade, 1 MHz or below, can be replaced by continuous control of -1 to +10 X the decade replaced. LOCAL CONTROL: Decade replaced is set by panel pushbuttons, frequency set by -1 to +10 continuous dial with added resolution of 2 significant digits (4, when self calibrated). REMOTE CONTROL: Frequency set by +0.3 V/step (0 to ±1.5 V) dc signal into 6 kΩ. SWEEP (FM) RATE: Dc to 1 kHz, ±1 dB. DEVIATION pk-pk: Same as sweep width. HARMONIC DISTORTION: 3%; rate, up to 100 kHz at reduced deviation. STABILITY: 0.001 X digit step of decade replaced per h, after 2-h warmup.

Signal Output 0 to 2 V rms, ac coupled, into ≥ 50Ω, flat ±1 dB above 50 Hz, metered with ±0.2-V accuracy. 0 to 800 mV rms, dc coupled, into ≥ 100 kΩ, flat ±0.2 dB to 10 kHz, not metered. Panel GR874# connector. LOCAL CONTROL: Single control with panel monitor. REMOTE CONTROL (1164 only): 6 to 10 V into 5 kΩ. FRACTIONAL FREQUENCY DEVIATION, averaging times of 10 ms and 1 s: 100 kHz: 3x10 ⁻⁴ (10 ms), 3x10 ⁻⁵ (1 s) 1 MHz: 3x10 ⁻⁴ (10 ms), 3x10 ⁻⁵ (1 s) 100 kHz: 3x10 ⁻⁴ (10 ms), 3x10 ⁻⁵ (1 s) HARMONICS, full output into 50 Ω: < -40 dB DISCRETE NON-HARMONICS: < -80 dB NOISE MODULATION, rms, 0.5 Hz to 15 kHz, re 1 rad for phase, re 100% carrier for amplitude: Phase: -70 dB Amplitude: -70 dB	0 to 2 V rms, behind 50 Ω, metered with ±10% accuracy above 0.2 V, 0 to 2 V rms behind 0 Ω, flat ±1.5 dB into 50 Ω above 50 Hz, metered. Panel GR874# connector. LOCAL CONTROL: Single control with panel monitor. REMOTE CONTROL (1164 only): 6 to 10 V into 5 kΩ. FRACTIONAL FREQUENCY DEVIATION, averaging times of 10 ms and 1 s: 10 MHz: 3x10 ⁻⁴ (10 ms), 3x10 ⁻⁵ (1 s) 1 MHz: 3x10 ⁻⁴ (10 ms), 3x10 ⁻⁵ (1 s) 100 kHz: 3x10 ⁻⁴ (10 ms), 3x10 ⁻⁵ (1 s) HARMONICS, full output into 50 Ω: < -30 dB DISCRETE NON-HARMONICS: < -60 dB NOISE MODULATION, rms, 0.5 Hz to 15 kHz, re 1 rad for phase, re 100% carrier for amplitude: Phase: -52 dB Amplitude: -70 dB	200 mV to 2 V rms, behind 50 Ω, metered, leveled ±5% ±0.02 V to 100 kHz, ±3% ±0.02 V above 100 kHz. Switch selects panel or rear GR874# connector. LOCAL CONTROL: Single control with panel monitor. REMOTE CONTROL (1164 only): 6 to 10 V into 5 kΩ. FRACTIONAL FREQUENCY DEVIATION, averaging times of 10 ms and 1 s: 70 MHz: 7x10 ⁻⁴ (10 ms), 3x10 ⁻⁵ (1 s) 10 MHz: 5x10 ⁻⁴ (10 ms), 5x10 ⁻⁵ (1 s) 1 MHz: 5x10 ⁻⁴ (10 ms), 5x10 ⁻⁵ (1 s) 100 kHz: 5x10 ⁻⁴ (10 ms), 5x10 ⁻⁵ (1 s) HARMONICS, full output into 50 Ω: < -60 dB DISCRETE NON-HARMONICS: < -60 dB NOISE MODULATION, rms, 0.5 Hz to 15 kHz, re 1 rad for phase, re 100% carrier for amplitude: Phase: -52 dB Amplitude: -60 dB
--	---	---

Auxiliary Outputs:

50 and 50/51 MHz at 100 mV into 1 kΩ from rear subminiature connectors.	39/50 and 50/51 MHz at 100 mV into 1 kΩ from rear subminiature connectors.	40/49 MHz at 100 mV into 1 kΩ; 30 and 90 MHz at 50 mV into 50 Ω; and 50/51 MHz at 25 mV into 50 Ω from rear subminiature connectors.
---	--	--

1 MHz at 400 mV into 1 kΩ; 5, 5/5.1 ref, and 42 MHz at 100 mV into 1 kΩ; from rear subminiature connectors; +18 V dc, up to 200 mA.

Coherent Decade Frequency Synthesizers

	with Manual/Programmable Step Decades				with Manual Step Decades					
	Smallest Step	0-100 kHz	0-1 MHz	30 Hz-12 MHz	10 kHz-70 MHz	0-100 kHz	0-1 MHz	30 Hz-12 MHz		10 kHz-70 MHz
Continuously Adjustable Search/Sweep Decade (CAD) Included	0.01 Hz	1161-AR7C 1161-9527				1161-A7C 1161-9597				Type Catalog No.
	0.1 Hz	1161-AR6C 1161-9526	1162-AR7C 1162-9527			1161-A6C 1161-9596	1162-A7C + 1162-9597			Type Catalog No.
	1.0 Hz	1161-AR5C 1161-9525	1162-AR6C 1162-9526	1163-AR7C 1163-9527		1161-A5C 1161-9595	1162-A6C 1162-9596	1163-A7C 1163-9597		Type Catalog No.
	10 Hz	1161-AR4C 1161-9524	1162-AR5C 1162-9525	1163-AR6C 1163-9526	1164-AR7C 1164-9527	1161-A4C 1161-9594	1162-A5C 1162-9595	1163-A6C 1163-9596	1164-A7C 1164-9597	Type Catalog No.
	100 Hz	1161-AR3C 1161-9523	1162-AR4C 1162-9524	1163-AR5C 1163-9525	1164-AR6C 1164-9526	1161-A3C 1161-9593	1162-A4C 1162-9594	1163-A5C 1163-9595	1164-A6C 1164-9596	Type Catalog No.
	1 kHz		1162-AR3C 1162-9523	1163-AR4C 1163-9524	1164-AR5C 1164-9525		1162-A3C 1162-9593	1163-A4C 1163-9594	1164-A5C 1164-9595	Type Catalog No.
	10 kHz			1163-AR3C 1163-9523	1164-AR4C 1164-9524			1163-A3C 1163-9593	1164-A4C 1164-9594	Type Catalog No.
Step Decades Only	0.01 Hz	1161-AR7 1161-9507				1161-A7 1161-9417				Type Catalog No.
	0.1 Hz	1161-AR6 1161-9506	1162-AR7 1162-9507			1161-A6 1161-9416	1162-A7 1162-9417			Type Catalog No.
	1.0 Hz	1161-AR5 1161-9505	1162-AR6 1162-9506	1163-AR7 1163-9507		1161-A5 1161-9415	1162-A6 1162-9416	1163-A7 1163-9417		Type Catalog No.
	10 Hz	1161-AR4 1161-9504	1162-AR5 1162-9505	1163-AR6 1163-9506	1164-AR7 1164-9507	1161-A4 1161-9414	1162-A5 1162-9415	1163-A6 1163-9416	1164-A7 1164-9417	Type Catalog No.
	100 Hz	1161-AR3 1161-9503	1162-AR4 1162-9504	1163-AR5 1163-9505	1164-AR6 1164-9506	1161-A3 1161-9413	1162-A4 1162-9414	1163-A5 1163-9415	1164-A6 1164-9416	Type Catalog No.
	1 kHz		1162-AR3 1162-9503	1163-AR4 1163-9504	1164-AR5 1164-9505		1162-A3 1162-9413	1163-A4 1163-9414	1164-A5 1164-9415	Type Catalog No.
	10 kHz			1163-AR3 1163-9503	1164-AR4 1164-9504			1163-A3 1163-9413	1164-A4 1164-9414	Type Catalog No.
100 kHz				1164-AR3 1164-9503				1164-A3 1164-9413	Type Catalog No.	

Patent Number 3,300,731

See page 315 for digit-insertion modules.

© Federal stock numbers are listed before the Index.

High-Frequency Oscillators

500 kHz-to-50 MHz Oscillators

Frequency: 500 kHz to 50 MHz with $\pm 2\%$ calibration accuracy and 0.4% typical warmup frequency drift. Variable L and C in main tuned circuit.

Output: 200 mW into 50 Ω , see curves (solid, 1269; dashed, 1264 or 1267 power supply).

Power: 1269, 1267, or 1263 power supply recommended (available as sets); 1201 or 1203 can be used.

Mechanical: Unit cabinet. DIMENSIONS (wxhxd depth behind panel): 8x7.63x9.75 in. (203x193x248 mm). WEIGHT: 12 lb (6 kg) net, 19 lb (9 kg) shipping.

Description	Catalog Number
500 kHz-to-50 MHz Oscillators	
1211-C, without power supply, Bench Model	1211-9703
1211-C9, with 1269-A Power Supply for maximum power:	
115-V Bench Model	1211-9439
115-V Rack Model	1211-9579
215-V Bench Model	1211-9449
215-V Rack Model	1211-9589
230-V Bench Model	1211-9459
230-V Rack Model	1211-9599
1211-C7, with 1267-B Power Supply for best cw stability and very low residual fm:	
115 to 230-V Bench Model	1211-9437
115 to 230-V Rack Model	1211-9577
1211-C3, with 1263-C Power Supply for monitored and leveled output and square-wave modulation:	
115-V Bench Model	1211-9433
115-V Rack Model	1211-9573
230-V Bench Model	1211-9443
230-V Rack Model	1211-9583

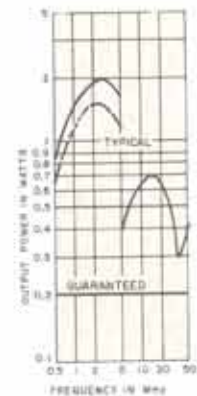

Description	Catalog Number
Rack Adaptor Sets, to rack mount bench models:	
480-P408 for 1211-C	0480-9848
481-P412 for 1211-C9 and 1211-C7	0481-9842
481-P416 for 1211-C3	0481-9846

50-to-250 MHz Oscillators

Frequency: 50 to 250 MHz with $\pm 1\%$ calibration accuracy and 0.2% typical warmup frequency drift. Semi-butterfly tuned circuit.

Output: To 125 mW into 50 Ω , see curves (solid, 1269; dashed, 1264 or 1267 power supply).

Power: 1269, 1267, 1264, or 1263 power supply recommended (available as sets); 1201 or 1203 can be used.

Mechanical: Unit cabinet. DIMENSIONS (wxhxd depth behind panel) 8x7.63x7.5 in. (203x193x191 mm). WEIGHT: 7.5 lb (3.5 kg) net, 10 lb (4.6 kg) shipping.

50-to-250 MHz Oscillators	
1215-C, without power supply, Bench Model	1215-9703
1215-C9, with 1269-A Power Supply for maximum power:	
115-V Bench Model	1215-9439
115-V Rack Model	1215-9579
215-V Bench Model	1215-9449
215-V Rack Model	1215-9589
230-V Bench Model	1215-9459
230-V Rack Model	1215-9599
1215-C7, with 1267-B Power Supply for best cw stability and very low residual fm:	
115 to 230-V Bench Model	1215-9437
115 to 230-V Rack Model	1215-9577
1215-C4, with 1264-B Power Supply for square-wave and pulse modulation:	
115-V Bench Model	1215-9434
115-V Rack Model	1215-9574
230-V Bench Model	1215-9444
230-V Rack Model	1215-9584

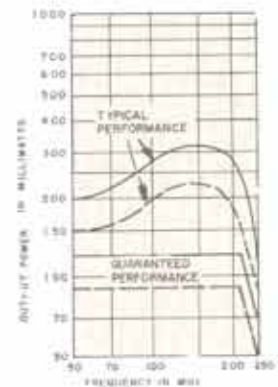

1215-C3, with 1263-C Power Supply for monitored and leveled output and squarewave modulation:	
115-V Bench Model	1215-9433
115-V Rack Model	1215-9573
230-V Bench Model	1215-9443
230-V Rack Model	1215-9583
Rack Adaptor Sets, to rack mount bench models:	
480-P408 for 1215-C	0480-9848
481-P412 for 1215-C7 and 1215-C9	0481-9842
481-P416 for 1215-C4 and 1215-C3	0481-9846

Ⓜ Federal stock numbers are listed before the Index.

56-to-500 MHz Oscillators

Frequency: 56 to 500 MHz with $\pm 2\%$ calibration accuracy and 0.8% typical warmup frequency drift. Variable L and C in main tuned circuit.

Output: To 250 mW into 50 Ω , see curve.

Power: 1269, 1267, 1264 or 1263 power supply recommended (available as sets); 1201 or 1203 can be used.

Mechanical: Convertible-Bench cabinet. DIMENSIONS (wxhx depth behind panel): 8x7.63x8.25 in. (203x193x210 mm). WEIGHT: 7.5 lb (3.5 kg) net, 10 lb (4.6 kg) shipping.

Description	Catalog Number
56-to-500 MHz Oscillators	
1363, without power supply, Bench Model	1363-9701
1363-A9, with 1269-A Power Supply for maximum power:	
115-V Bench Model	1363-9419
115-V Rack Model	1363-9509
215-V Bench Model	1363-9429
215-V Rack Model	1363-9519
230-V Bench Model	1363-9439
230-V Rack Model	1363-9529
1363-A7, with 1267-B Power Supply for best cw stability and very low residual fm:	
115 to 230-V Bench Model	1363-9417
115 to 230-V Rack Model	1363-9507
1363-A4, with 1264-B Power Supply for square-wave and pulse modulation:	
115-V Bench Model	1363-9414
115-V Rack Model	1363-9504
230-V Bench Model	1363-9424
230-V Rack Model	1363-9514

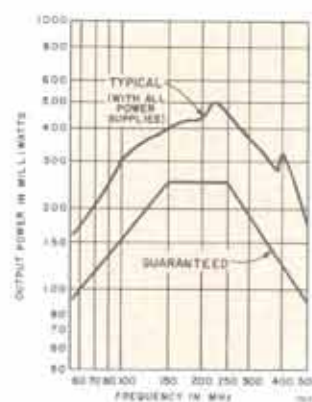

Description	Catalog Number
Rack Adaptor Sets, to rack mount bench models:	
480-P408 for 1363	0480-9848
481-P412 for 1363-A7 and 1363-A9	0481-9842
481-P416 for 1363-A4 and 1363-A3	0481-9846

220-to-920 MHz Oscillators

Frequency: 220 to 920 MHz with $\pm 1\%$ calibration accuracy and 0.2% typical warmup frequency drift. Butterfly tuned circuit.

Output: To 200 mW into 50 Ω , see curves (solid, 1269; dashed, 1264 or 1267 power supply). Calibrated attenuator.

Power: 1269, 1267, 1264, or 1263 power supply recommended (available as sets); 1201 or 1203 can be used.

Mechanical: Convertible-Bench cabinet. DIMENSIONS (wxhx depth behind panel): 8x7.63x8.25 in. (203x193x210 mm). WEIGHT: 8 lb (3.4 kg) net, 11 lb (5 kg) shipping.

220-to-920 MHz Oscillators	
1362, without power supply, Bench Model	1362-9701
1362-A9, with 1269-A Power Supply for maximum power:	
115-V Bench Model	1362-9419
115-V Rack Model	1362-9509
215-V Bench Model	1362-9429
215-V Rack Model	1362-9519
230-V Bench Model	1362-9439
230-V Rack Model	1362-9529
1362-A7, with 1267-B Power Supply for best cw stability and very low residual fm:	
115 to 230-V Bench Model	1362-9417
115 to 230-V Rack Model	1362-9507
1362-A4, with 1264-B Power Supply for square-wave and pulse modulation:	
115-V Bench Model	1362-9414
115-V Rack Model	1362-9504
230-V Bench Model	1362-9424
230-V Rack Model	1362-9514

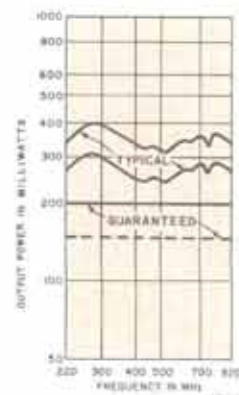

1362-A3, with 1263-C Power Supply for monitored and leveled output and square-wave modulation:	
115-V Bench Model	1362-9413
115-V Rack Model	1362-9503
230-V Bench Model	1362-9423
230-V Rack Model	1362-9513
Rack Adaptor Sets:	
480-P408 for 1362	0480-9848
481-P412 for 1362-A7 and 1362-A9	0481-9842
481-P416 for 1362-A4 and 1362-A3	0481-9846

⊗ Federal stock numbers are listed before the Index.

450-to-1050 MHz Oscillators

Frequency: 450 to 1050 MHz with $\pm 1\%$ calibration accuracy and 0.2% typical warmup frequency drift. Butterfly tuned circuit with logarithmic frequency scale.

Output: To 150 mW into 50 Ω , see curves (solid, 1269; dashed, 1264 or 1267 power supply). Calibrated attenuator.

Power: 1269, 1267, 1264, or 1263 power supply recommended (available as sets); 1201 or 1203 can be used.

Mechanical: Convertible-bench cabinet. DIMENSIONS (wxh depth behind panel): 8x7.63x8.25 in. (203x193x210 mm). WEIGHT: 7 lb (3.2 kg) net, 11 lb (5 kg) shipping.

Description	Catalog Number
450-to-1050 MHz Oscillators	
1361-A, without power supply, Bench Model	1361-9701
1361-A9, with 1269-A Power Supply for maximum power:	
115-V Bench Model	1361-9419
115-V Rack Model	1361-9509
215-V Bench Model	1361-9429
215-V Rack Model	1361-9519
230-V Bench Model	1361-9439
230-V Rack Model	1361-9529
1361-A7, with 1267-B Power Supply for best cw stability and very low residual fm:	
115 to 230-V Bench Model	1361-9417
115 to 230-V Rack Model	1361-9507
1361-A4, with 1264-B Power Supply for square-wave and pulse modulation:	
115-V Bench Model	1361-9414
115-V Rack Model	1361-9504
230-V Bench Model	1361-9424
230-V Rack Model	1361-9514

900 MHz-to-2 GHz Oscillators

With its electronic frequency control, the 1218-BV can be phase locked to an external reference signal to provide high power, low noise, and the stability of the reference signal against warmup drift and microphonics. In heterodyne systems, where a difference signal must be stable to remain within the bandwidth of a tuned detector, the 1218-BV can be used as the local oscillator. With a phase detector operating at the difference frequency, the 1218-BV can track small changes in the frequency of the test oscillator and hold the difference frequency steady.

— See *GR Experimenter* for November-December 1968.

Frequency: 900 to 2000 MHz with $\pm 1\%$ calibration accuracy and 0.1% typical warmup frequency drift. Main tuning by tracked adjustable lines.

Fine Tuning: MANUAL: $> \pm 2$ MHz, by turning of Δf knob. Power-level pulling by Δf control is ≈ 0.5 dB for ± 2 MHz change. REMOTE: > 4 MHz for 50 V change in dc signal applied to front or rear jacks; ± 25 V typical useful range; Δf control sets center value from +10 to -20 V. Positive-going voltage decreases frequency. Applied voltage ± 50 V max. Input equivalent to 10 k Ω , 150 pF, and -1.3 mA current source in parallel across terminals, one of which is grounded. Ext source should have $< 1000 \Omega$ internal impedance; can be ac coupled. Step-response time $< 1 \mu$ s typical.

Output Level: > 160 mW into 50 Ω to 1.5 GHz, drops linearly to > 110 mW at 2 GHz, see curve. CONTROL: > 20 -dB attenuation by uncalibrated control. EXTERNAL MODULATION: Panel jack provided for external audio-frequency modulation; ≈ 30 V rms into 6 k Ω produces 30% a-m.

Power: 1267, 1264, or 1263 power supply recommended (available as sets); 1201 can be used.

Mechanical: Unit cabinet. DIMENSIONS (wxh depth behind panel): 12x7.63x7.5 in. (305x193x191 mm). WEIGHT: 14 lb (7 kg) net, 26 lb (12 kg) shipping.

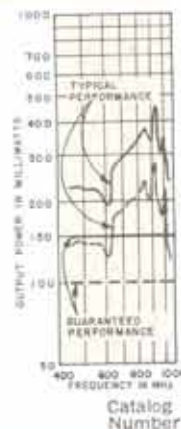
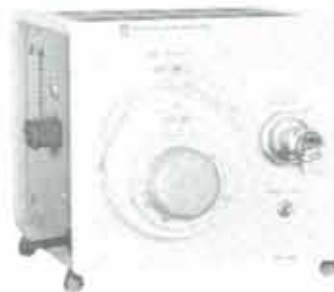

Description	Catalog Number
1361-A3, with 1263-C Power Supply for monitored and leveled output and square-wave modulation:	
115-V Bench Model	1361-9413
115-V Rack Model	1361-9503
230-V Bench Model	1361-9423
230-V Rack Model	1361-9513
Rack Adaptor Sets, to rack mount bench models:	
480-P408 for 1361-A	0480-9848
481-P412 for 1361-A7 and 1361-A9	0481-9842
481-P416 for 1361-A4 and 1361-A3	0481-9846

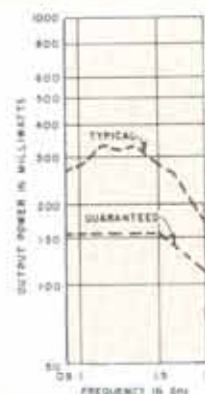

900-MHz-to-2 GHz Oscillators	
1218-BV, without power supply, Bench Model	1218-9724
1218-BV7, with 1267-B Power Supply for best cw stability and very low residual fm:	
115 to 230-V Bench Model	1218-9905
115 to 230-V Rack Model	1218-9906
1218-BV4, with 1264-B Power Supply for square-wave and pulse modulation:	
115-V Bench Model	1218-9903
115-V Rack Model	1218-9904
230-V Bench Model	1218-9913
230-V Rack Model	1218-9914
1218-BV3, with 1263-C Power Supply for monitored and leveled output and square-wave modulation:	
115-V Bench Model	1218-9901
115-V Rack Model	1218-9902
230-V Bench Model	1218-9911
230-V Rack Model	1218-9912
Rack Adaptor Sets, to rack mount bench models:	
481-P412 for 1218-BV	0481-9842
481-P416 for 1218-BV7	0481-9846
482-P412 for 1218-BV4 and 1218-BV3	0482-9842

Oscillator Power Supplies

1269-A for non-critical applications The 1269-A provides unregulated voltages, at a savings, for less stringent requirements.

1267-B for regulated voltages For such applications as parametric-amplifier pumps, the oscillator must be stable against all power-line variations and free of modulation from power-supply ripple. In these applications, the 1267-B, 1264-B, and 1263-C power supplies are recommended because of their regulated outputs.

1264-B for amplitude modulation Other applications require power supplies in which the plate-supply voltage is controllable to modulate or to regulate the oscillator output. The 1264-B provides 100% amplitude modulation at a high level by square waves or pulses as well as cw operation. Both plate and heater supplies are electronically regulated and the internal 1-kHz modulation frequency is highly stable.

A switch permits cw, standby, internal square-wave modulated, or externally modulated operation. Independen-

dent panel controls vary the regulated supply voltage for cw operation and the modulation amplitude for square-wave and pulse operation.

1263-C for leveled output and amplitude modulation

The 1263-C is particularly useful in a feedback loop to maintain constant oscillator output as the oscillator frequency is varied. Constant output not only speeds and simplifies measurements where the oscillator is tuned manually but is essential when sweep measurements are being made. Both plate and heater supplies are regulated and an internal 1-kHz is included for square-wave modulation.

The dc potential developed by the oscillator output rectifier is compared with an adjustable dc reference in the feedback system. A rapid correction is applied to the plate current to hold the oscillator output to a preset level. Rf blanking can be accomplished by external shorting of the reference potential.

SPECIFICATIONS

Supplied: Power cord, output-socket mating plug (entire cable for 1263) plus (for 1263) a GR874-to-GR874 coaxial patch cord, 874-VRL Voltmeter Rectifier, 874-EL-L 90° Ell.

Available: Rack adaptor sets for power supplies separately or with oscillators.

Description	Catalog Number
1269-A Power Supply , bench models:	
115-V model	1269-9701
215-V model	1269-9711
230-V model	1269-9712
1267-B Regulated Power Supply , bench models:	
115/215/230-V model	1267-9702
1264-B Modulating Power Supply , bench models:	
115-V model	1264-9702
230-V model	1264-9703
1263-C Amplitude-Regulating Power Supply , bench models:	
115-V model	1263-9703
230-V model	1263-9713
Rack Adaptor Set , for 1264-B or 1263-C alone (other combinations are available)	0480-9848
1264-P1 Adaptor Cable , used when 1264-B powers 1215-C Oscillator (included in 1215-C4 set)	1264-9601



1269-A Filtered Power Supply



1267-B Regulated Power Supply



1264-B Modulating Power Supply



1263-C Amplitude-Regulating Power Supply

High Output:	300 V $\pm 5\%$, at 50 mA; 410 V with no load; at nominal line voltage. < 80-mV ripple at full load, 50 mA max.	300 V, 70 mA max; voltage regulation: $\pm 0.25\%$ for line and load changes. < 1-mV ripple at full load.	200 to 300 V adjustable, 50 mA max; < 0.5-V change for 10-V line change. < 1-mV ripple (B- grounded), < 5-mV ripple (B+ grounded).	0 to 300 V adjustable, 30 mA max. < 1-mV ripple at full load.
Low Output:	6.3 V ac, 3 A max, unregulated.	6.5 V dc, 1 A max; $\pm 0.25\%$ regulation for line changes.	6.2 to 6.8 V dc adjustable, 1 A max; < 5-mV change with 10-V line change. < 5-mV ripple at full load.	6.5 V dc, 1 A max; regulated. < 1-mV ripple.
Modulated Output:	None	None. Standby switch controls 300-V output independently.	850 to 1150 Hz* internal square wave, adjustable to within 0.3 Hz of desired value (20 Hz to 50 kHz by external 20- to 50-V rms sine-wave input, to 100 kHz by external 20-V positive pulse). < 0.1% (0.04% typical) frequency change for 10-V line change; 0.5 $\pm 5\%$ adjustable duty ratio. 160 to 210 V adjustable output. < 1.5 μ s rise and decay times for 15-k Ω /300-pf load; no rampoff.	950 to 1050 Hz** internal squarewave, adjustable; < 5-Hz change with line changes; 0.5 to 0.53 adjustable duty ratio; 50 μ s rise and decay, no overshoot, < 0.5% rampoff.
Regulation of Oscillator Output Level:	None	None	None	Under $\pm 5\%$ rf-output change† (including effects of harmonics) below 500 MHz, with 1211, 1215, 1362 oscillators.
Output Voltmeter:	None	None	None	Reads average of rms carrier level with 1-kHz squarewave modulation; accuracy $\pm 10\%$ after standardizing with internal circuit and rectifier correction for extremely high frequencies.
Power:	105 to 125, 195 to 235, or 210 to 250V, 50 to 60 Hz (400 Hz with 5% increase in voltage requirements).		105 to 125 or 210 to 250 V, 50 to 60 Hz.	
	50 W	75 W	85 W	55 W
Mechanical:	Convertible-Bench cabinet. DIMENSIONS (wxhxd): 4.25x7.63x9.25 in. (108x193x235 mm). WEIGHT: 1269, 6 lb (2.7 kg) net, 8 lb (3.7 kg) shipping; 1267, 8 lb (3.7 kg) net, 10 lb (4.6 kg) shipping.		Convertible-Bench cabinet. DIMENSIONS (wxhxd): 8x7.63x9.25 in. (203x193x235 mm). WEIGHT: 1264, 12 lb (5.5 kg) net, 15 lb (7 kg) shipping; 1263, 15 lb (7 kg) net, 18 lb (9 kg) shipping.	

* Internal squarewave generator can be synchronized to external sinewave or squarewave signal, sync range is $> \pm 1\%$ for 5-V-rms, 1-kHz sinewave. In internal squarewave mode, a sync output of > 2 V pk-pk behind 18 k Ω is provided.

** A gate output is coincident with "off" interval of modulation, > 1 V into 30 k Ω \neq 300 pF; < 50- μ s rise and decay times; < 0.01 V during "on" interval.

† Correction time for 2:1 step change in selected oscillator output is < 0.5 ms, cw; < 50 ms 1-kHz squarewave modulated. Recovery time after blanking, < 2 ms, cw; < 200 ms, 1-kHz squarewave modulated. Hum and noise < $\pm 0.3\%$, cw, < $\pm 3\%$, 1-kHz squarewave modulated.

Ⓢ Federal stock numbers are listed before the Index.

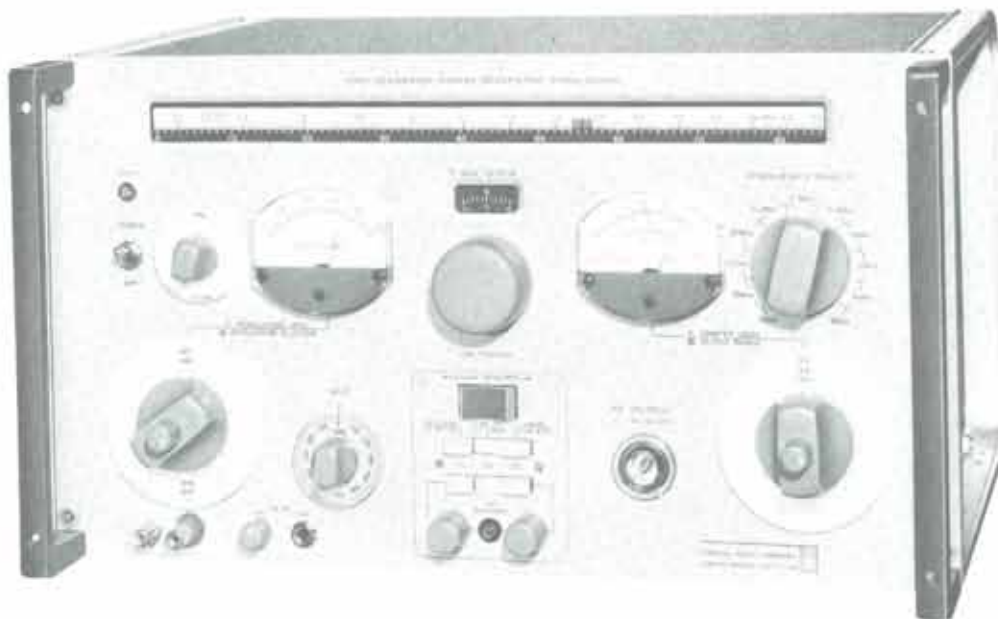

1003 Standard-Signal Generator

- 67 kHz to 80 MHz
- 1 ppm typical over-all stability
- variable-speed sweep
- optional programmability and crystal calibrator
- 180-mW output (3 V across 50 Ω)
- 0 to 95% a-m

High stability The GR 1003 achieves a 10-to-1 improvement in frequency stability without sacrificing the other performance characteristics expected in a fine signal generator. The frequency-generating system is a single-range, highly stable oscillator followed by frequency dividers to provide the successively lower ranges. Thus the high stability of one range is the stability of all, and range switching is accomplished without any transient instability. All-solid-state design ensures both low-drift warmup and high reliability.

Applications Important in the testing of devices with steep-slope frequency characteristics are the stability, residual fm, and settability of the signal source. Noise, drift, or poor resolution can make it impossible to determine the test frequency accurately enough. The 1003 eliminates these obstacles without introducing spurious outputs, tuning complications, and potential signal leakage.

Sweep operation and automatic tuning Two models of the 1003 contain the Auto-Control/Sweep Unit which enables the generator to be tuned automatically on command to within 0.1% of any preset frequencies. Two frequencies, which will also act as limits for sweep operation, can be set on front-panel controls; additional frequencies can be preset externally for automatic tuning. In the swept mode, the sweep rate can be set from 0.05 to 5%

per second and the sweep limits from 0.2% of the center frequency to the full width of the frequency range in use. Two potentiometers generate horizontal-sweep voltages with resolution suitable for both narrow- and wide-band sweeping. The rf output is blanked during return sweep and an external blanking voltage is also generated.

The simpler manual-control models use a fast, fixed-speed drive motor for rapid coarse tuning and a very fine manual vernier; this combination justifies the use of a long, high-resolution frequency scale.

Frequency control Vital to the use of a standard-signal generator is the accuracy with which frequency can be determined, both absolute and relative. The long slide-rule of the 1003 is calibrated to within 0.25% for absolute frequency readings; this main tuning control also has a vernier scale that permits small changes and interpolation between crystal-calibrator frequencies to be made to a resolution of 0.01%.

A separate front-panel Δf control, calibrated in ppm, tunes electronically over a ± 500 -ppm range with a resolution of 2 ppm. External control of this electronic tuning facilitates phase locking the generator frequency and gives a limited fm capability.

With external counters, for which outputs are provided, these high-resolution capabilities can be further extended to absolute frequency settability.

Thus, the excellent stability and control of the 1003 ensure that its frequency will change only when, and by the exact amount, desired by the operator.

Modulation Internal 400- and 1000-Hz a-m is adjustable and metered 0 to 95%; it has very low distortion owing to the use of envelope feedback. External a-m is provided for with a 20-kHz ac mode and a direct-coupled mode for remote level control and low-frequency square-wave modulation. Incidental fm is unusually low.

— See *GR Experimenter* for July-August 1967 and September-October 1969.

SPECIFICATIONS

Frequency: 67 kHz to 80 MHz in 10 ranges of 67 to 156, 135 to 312, 270 to 625, 540 to 1250 kHz, 1.08 to 2.5, 2.16 to 5, 4.32 to 10, 8.64 to 20, 17.28 to 40, and 34.56 to 80 MHz. **ACCURACY:** $\pm 0.25\%$ ($\pm 0.1\%$ typical); 140-in. logarithmic scale, plus logging scale, with vernier, of 8500 div, 0.01%/div.

Crystal Calibrator (in some models): Markers at 50-kHz, 200-kHz, and 1-MHz intervals, accurate to 20 ppm. Beat level adjustable and suitable for sweep-calibration purposes.

Tuning: **MANUAL:** 1% per revolution of manual fine-tuning control, calibrated in 0.01% increments; fast tuning by push-button-controlled drive motor. **ELECTRONIC:** Internal ± 500 ppm nominal, settable to better than 2 ppm. External = 60 ppm/V to ± 1000 ppm typical, limited fm capability. Input ± 15 V max into 15 k Ω ; +V increases frequency.

Auto-Control (Auto-Control models only): **TUNING:** Tunes on command to preset frequencies (2 set by panel controls, others by external voltages or voltage dividers); tuning speed = 5%/s, positioning accuracy 0.1%. **SWEEP:** Width adjustable from 0.2% of center frequency to full width of selected range. Rate adjustable from $\Delta f/f$ of 0.05% to 5%/s. Sweep-voltage output of 1 V/1% frequency change for sweep widths to 4% ($\pm 2\%$ of center frequency); for wide sweeps output is ≈ 65 mV for 1% frequency change. Either output can be centered with respect to ground. Blanking voltage of +9V behind 15 k Ω (separate from sweep voltage) available during return sweep. **ANALOG OUTPUT:** = -7 V to 0 V behind 7.5 k Ω (≈ 82 mV/1% frequency change) proportional to shaft position or logging scale.

Stability: < 5 ppm per 10 min after warmup, 1 ppm typical. Frequency varies < 1 ppm with $\pm 10\%$ line-voltage change, range switching (instant restabilization), rf-level adjustments, or load variations. Warmup drift, 150 ppm typical, in 3 h at 20°C.

Distortion and Noise: **DISTORTION:** $< 5\%$ typical. **RESIDUAL A-M** due to hum and noise within 15 kHz: ≥ 85 dB down, relative to carrier. **RESIDUAL FM:** < 3 Hz pk at high-frequency end, < 1 Hz pk at low-frequency end.

Rf Output: **CW:** 0.05 μ V to 3 V across 50 Ω (-133 to $+22.6$ dBm; to 180 mW). **MODULATED:** 0.05 μ V to 1.5 V across 50 Ω (-133 to $+16.6$ dBm; to 45 mW). **IMPEDANCE:** 50 Ω . **SWR:** < 1.02 with attenuator set for 0 dBm or less, < 1.05 for $+10$ dBm, < 1.20 for $+20$ dBm. **CONTROL:** 155 dB total, i.e., 140 dB in 10-dB steps with attenuator plus 10 dB or more with continuous control. **LEVELING:** At full power, accurate to ± 1 dB; allowance for attenuator, ± 0.1 dB/10-dB step, ± 0.5 dB max accumulated error. **STABILITY:** Warmup drift < 0.3 dB, temperature effects < 0.01 dB/°C, line-voltage variations < 0.02 dB. **METER:** Reads volts across 50 Ω and dBm.

Modulation: **LEVEL:** 0 to 95% continuously adjustable. Stable within ± 1 dB independent of carrier or modulation frequency (within modulation bandwidth) and output level. **BANDWIDTH:** At 100-kHz carrier, 500-Hz max modulation frequency for 95% a-m and 2 kHz for 30% a-m; > 1 -MHz carrier, 3 kHz max for 95%; > 2.5 -MHz carrier, 10 kHz max for 50%. **METER:** Reads 0 to 100%. Accuracy $\pm 5\%$ fs with internal modulation, $\pm 10\%$ fs with external modulation, 0 to 95% within modulation bandwidth. **INCIDENTAL ANGLE MODULATION:** < 0.1 rad pk at 30% a-m. **INTERNAL:** 400 and 1000 Hz $\approx 0.5\%$, 2-V output behind 100 k Ω available at panel connector. Envelope distortion: $< 1\%$ at 50% a-m, $< 2\%$ at 70% a-m. **EXTERNAL:** Ac coupled, 20 Hz to 20 kHz, 2 V into 2.5 k Ω for 95% modu-

lation within modulation bandwidth. Dc coupled, dc to 20 kHz, carrier off with 0-V input; 1.5-V output into 50 Ω with $+5$ V into 10 k Ω . Max input 10 V pk.

Auxiliary Outputs: **MAIN FREQUENCY:** ≥ 0.5 V pk-pk cw into 50 Ω at output carrier frequency. **SUBHARMONIC FREQUENCY:** ≥ 0.3 V pk-pk = squarewave behind 150 Ω . Frequency between 67 and 156 kHz is coherent and integrally related to carrier frequency by factor N shown on main dial.

Environment: **LEAKAGE:** Negligible effect on receiver sensitivity measurements down to 0.1 μ V. **TEMPERATURE:** 10 to 50°C operating.

Supplied: GR874-to-GR874 patch cord, power cord, two 12-pin connectors for external controls.

Power: 105 to 125, 195 to 235, or 210 to 250 V, 50 to 60 Hz (to 400 Hz for Auto-Control models), 33 W max.

Mechanical: Rack-bench cabinet. **DIMENSIONS (wxhxd):** Bench, 19x11x15.25 in. (483x279x387 mm); rack, 19x10.5x12.75 in. (483x267x324 mm). **WEIGHT:** 64 lb (30 kg) net, 87 lb (40 kg) shipping.

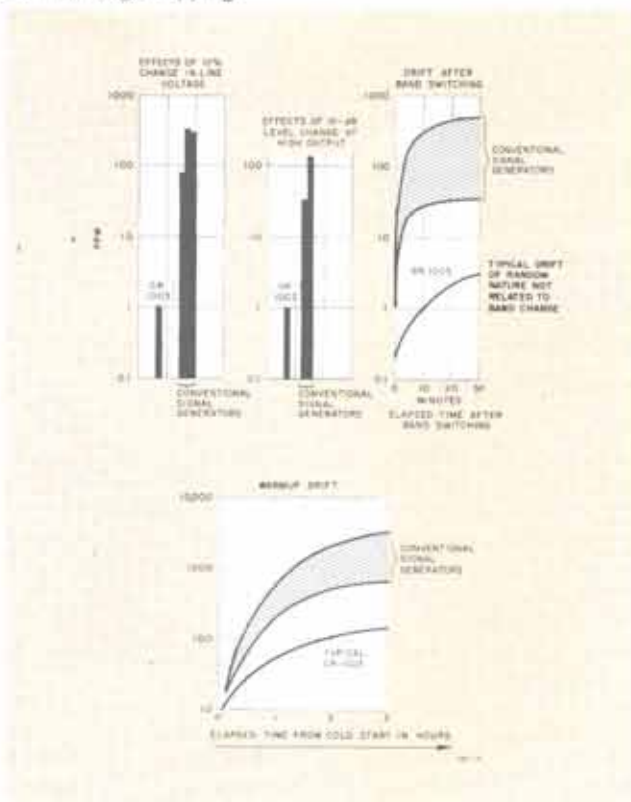

The stability of the 1003 compared with that of other signal generators.

Description	Catalog Number
1003 Standard-Signal Generator	
Basic model	1003-9701
With Auto-Control / Sweep Unit	1003-9702
with Crystal Calibrator	1003-9703
with Auto-Control and Crystal Calibrator	1003-9705
Patent Number 3,529,260.	

Ⓜ Federal stock numbers are listed before the index.

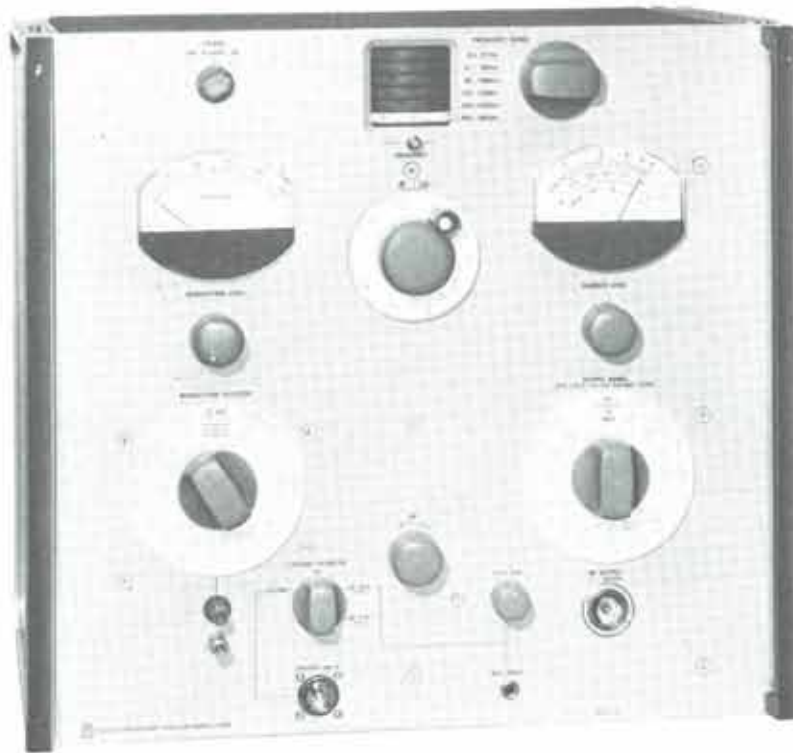

1026 Standard-Signal Generator

- 9.5 to 500 MHz, single-dial tuning
- 5-V output across 50 Ω (500 mW), leveled
- crystal calibrator
- incidental fm < 1 ppm + 100 Hz
- audio, video, and pulse a-m
- fm and phase-lock capability

Applications This vhf signal generator was designed to meet the most exacting requirements for measurements on a-m receivers, filters, attenuators, and other components and incorporates many convenience features to let the operator give his full attention to the measurement rather than the instrumentation. The ease of operation and outstanding performance of the 1026 in the most critical applications must be experienced to be appreciated.

Unusually high-level output signals are available for antenna-pattern and impedance measurements, receiver overload and cross-modulation tests, and measurements of large insertion losses without auxiliary amplifiers and the attendant setup and tuning problems. Similarly, precision attenuation and excellent shielding make possible tests with the very low signal levels required in other receiver measurements. Carrier distortion, residual a-m and fm, and incidental fm are all kept to very low levels.

Leveling High-gain feedback of the detected carrier to the modulation amplifier provides very precise leveling in all modes of operation, modulated and unmodulated. With audio modulation, envelope feedback ensures low envelope distortion; with pulse modulation, the peak of the pulsed carrier is leveled.

Modulation versatility Amplitude modulation up to 95% can be imposed on the carrier from a highly stable internal 1-kHz oscillator or from an external audio source. The dc-coupled modulation input eliminates low-frequency phase-shift modulation. The characteristics are suitable for glide-slope and omni-range receivers. In addition, the generator has provisions for wide-band external modulation to 300 kHz and for pulse modulation with an on-off ratio typically greater than 40 dB at full output. An accurate panel meter monitors modulation levels.

High accuracy The main frequency drum scales are accurate to $\pm 0.5\%$ direct reading and can be calibrated even more closely over small spans through use of the internal 1 and 5 MHz crystal frequencies, both of which are usable to 500 MHz and are accurate to $\pm 0.001\%$. The fiducial mark is adjustable to permit easy scale calibration. Also provided is an auxiliary output to drive a frequency counter for extreme precision in the setting and measuring of generator frequency. This output can be disabled at will and isolated by > 100 dB. An external signal applied to this same terminal will beat with the generator frequency and generate a difference frequency that is available at the Beat output jack; thus the 1026 will serve as a heterodyne frequency meter as well.

Fm and phase-locked operation The generator frequency can be electrically controlled by an external dc or audio frequency signal. Good linearity is attained for narrow-band fm throughout the carrier frequency range; in the important 88-108 MHz range, peak deviations up to 100 kHz are readily obtainable. Using an external phase detector and dc amplifier, one can phase-lock the generator frequency to an external frequency standard for stability.

Convenient Many features are included which not only mean convenience for the operator but will also reduce potential errors and permit operation by less-skilled personnel. True single-dial frequency control speeds frequency setting and eliminates the misadjustments possible with signal generators in which the amplifier tracking depends upon auxiliary-trimmer adjustment by the operator. A parallax-free fiducial mark and illumination of

only the scale in use reduce possible error in frequency readings. All controls and indicators are grouped by function, and their use is self-evident, obviating frequent reference to operating instructions. Output connectors are easily convertible to practically any common coaxial connectors with GR874® adaptors.

— See *GR Experimenter* for March 1967.

SPECIFICATIONS

Frequency: 9.5 to 500 MHz in 6 ranges (lowest 3 ranges are linear):

Frequency Range (MHz)	Main-Scale Interval	Vernier-Scale Interval (kHz)	Scale Length (in.)
9.5 to 22	100 kHz	5	14.25
21.2 to 49.6	200 kHz	11	14.25
47.4 to 111	500 kHz	25	14.25
100 to 220	1 MHz	45 to 60	13
215 to 430	2 MHz	80 to 150	10.5
400 to 500	2 MHz	150	4

ACCURACY: $\pm 0.5\%$ direct reading, after initial adjustment of fiducial mark; $\pm 0.01\%$ with internal crystal calibrator at 1.0-MHz intervals, $\pm 0.05\%$ typical by interpolation.

Calibration Provisions: INTERNAL CRYSTAL FREQUENCY: $\pm 0.001\%$ accuracy, provides calibration at 1- and 5-MHz intervals over entire frequency range. EXTERNAL COUNTER: Output of ≈ 0.1 to 1 V behind 500 Ω provided for calibration by counter. When not needed, output can be disabled with > 100 -dB isolation; external counter can be simultaneously disabled by a contact closure to eliminate interference from counter's internal signals.

Tuning: MANUAL: Main frequency control, spinner knob with 100-division vernier (25 turns per range) drives main drum-type dial; illuminated scale indicates selected range; parallax-free fiducial mark is adjustable for fine calibration. Uncalibrated Δf control spans $\pm 0.003\%$ typical at low end of range to $\pm 0.015\%$ at high end; actual spans can vary 2:1 depending on frequency range. ELECTRONIC: External ± 20 V dc signal varies frequency $\pm 0.04\%$ typical at low end of range to $\pm 0.2\%$ at high end; actual spans can vary 2:1 depending on frequency range.

Stability: < 50 ppm per 10 min after 1-h warmup to 400 MHz; < 100 ppm per 10 min to 500 MHz; < 10 min required for stabilization after frequency change.

Harmonic Output: > 30 dB below carrier.

RF Output: CW: 0.05 μ V to 5 V across 50 Ω (-133 to $+27$ dBm; to 500 mW). MODULATED: 0.05 μ V to 2.5 V across 50 Ω (-133 to $+21$ dBm; to 125 mW). Load SWR > 2.0 may restrict max output at some frequencies. IMPEDANCE: 50 Ω resistive. SWR: < 1.05 with attenuator set 0 dB or less; < 1.2 for higher outputs, the source being viewed as a Thevenin generator. CONTROL: 140 dB in 10-dB steps with voltage and dBm calibration; continuous interpolation with metered level control. Attenuator accuracy $\pm 1\%$ (± 0.1 dB) per step to -110 dBm, $\pm 2\%$ (± 0.2 dB) per step to -120 dBm; ± 0.5 -dB max accumulated error. CW output leveled to $\pm 3\%$ (0.3 dB) to 108 MHz and $\pm 5\%$ (0.5 dB) to 500 MHz. STABILITY: Output constant within ± 0.0025 dB/min or ± 0.01 dB/15 min after 2-h warmup; line-voltage variation, ± 0.005 dB, max. METER: Scales of 0.15 to 0.8 V, 0.5 to 2.5 V, and -13 to $+1$ dBm; scale extensions (in red, for cw use only) to 5 V and to $+7$ dBm. Metering accuracy $\pm 5\%$ to 108 MHz; above 108

MHz, harmonics can add $\pm 3\%$ and rectifier characteristic can add $\pm 2\%$ errors.

Modulation: Amplitude modulation provided in four modes: INTERNAL 1 kHz: Modulation level adjustable 0 to $> 95\%$ and metered to within $\pm 3\%$ of reading $\pm 2\%$ of full scale. Envelope feedback provides leveling and holds distortion to $< 1\%$ at 30% modulation and $< 3\%$ at 80% modulation. Modulating frequency, 1 kHz $\pm 0.5\%$; after 2-hour warmup stable to better than 0.1% over 8-hour period or for line-voltage variations of $\pm 10\%$. 1-kHz signal available at MOD binding posts, about 2.5 V behind 100 k Ω .

EXTERNAL AUDIO: Response flat to dc, down < 0.5 dB at 10 kHz. Square-wave response 0 to 10 kHz; rise and fall time < 10 μ s; overshoot $< 10\%$; rampoff negligible. Modulation is adjustable 0 to $> 95\%$ for dc to 5-kHz input, to $> 70\%$ at 10 kHz, and is metered to within $\pm 5\%$ of reading $\pm 5\%$ of full scale for sine-wave inputs from 20 Hz to 10 kHz. For 95% modulation < 3 V, peak required into 3 k Ω . Envelope feedback provides leveling and holds distortion at 30% modulation to $< 1\%$ up to 1 kHz, $< 5\%$ up to 10 kHz.

EXTERNAL WIDE BAND: Modulation level adjustable 0 to $> 80\%$. Response flat to ± 3 dB for 50-Hz to 300-kHz inputs at carrier frequencies above 108 MHz. Average carrier is leveled and metered, but modulation depth and linearity should be monitored externally. For full modulation, about 0.6 to 3.5 V (depending on carrier frequency) are required into 3 k Ω .

EXTERNAL PULSE: Required input pulses, at least 10 V peak, positive going (max 30 V); repetition rate 500 Hz to 150 kHz; duration 1 to 300 μ s (min 3 μ s on 9.5- to 22-MHz range); max 50% duty ratio. Input impedance 3 k Ω . Output pulse, duration within ± 0.5 μ s of input; rise and fall times < 1 μ s each on all ranges but 9.5 to 22 MHz (up to 3 μ s); rampoff $< 5\%$. On-off ratio > 30 dB; at max output setting of carrier level is typically > 40 dB. Peak amplitude of pulses is leveled and metered to within ± 1 dB added to accuracy specified for cw leveling.

INCIDENTAL FM (accompanying a-m): < 1 ppm ± 100 Hz pk at 1 kHz, 50% a-m. RESIDUAL FM: < 0.05 ppm pk. RESIDUAL A-M Due to hum and noise in 15-kHz bandwidth; ≥ 70 dB below carrier level in cw, internal 1-kHz, and external-audio modes.

Environment: LEAKAGE: Negligible effect on receiver sensitivity measurements down to 0.1 μ V.

Supplied: GR874-to-GR874 patch cord, power cord, 12-pin connector for external controls, phone plug.

Power: 105 to 125 or 200 to 250 V, 50 to 60 Hz, 90 W max.

Mechanical: Rack-bench cabinet. DIMENSIONS (wxhxd): Bench, 19x17.75x15.25 in. (483x451x387 mm); rack, 19x17.5x13 in. (483x445x330 mm). WEIGHT: 96 lb (44 kg) net, 156 lb (72 kg) shipping.

Description

Catalog Number

1026 Standard-Signal Generator

1026-9701

1001-A Standard-Signal Generator

- 5 kHz to 50 MHz
- 0 to 80% amplitude modulation
- 0.05 μV to 100 mV

Multiple use The 1001-A is an excellent laboratory instrument for the testing of receivers and other audio or rf equipment. Its simplicity also suits it to production testing and its compact, light-weight construction adapts it for use in field-strength measurements. Frequency precision is constant due to the logarithmic dial calibration, and a vernier is calibrated directly in percentage frequency increments.

Internal amplitude modulation from 0 to 80% at 400 Hz is possible, and a panel meter allows either the carrier-level or the modulation percentage to be monitored.

SPECIFICATIONS

Frequency: 5 kHz to 50 MHz in 8 ranges, with ends at 5, 15, 50, 150, 500 kHz and 1.5, 5, 15, and 50 MHz. **ACCURACY:** $\pm 1\%$ of reading. Logarithmic scale to 15 MHz, departs slightly from logarithmic at higher frequencies. Vernier-dial frequency increment is 0.1% per division to 15 MHz.

Stability: $\approx 0.25\%$ warmup drift; half the maximum is reached in ≈ 1.5 hr.

Signal Purity: **DISTORTION:** Envelope distortion $< 8\%$ at 80% a-m; carrier distortion $\approx 7\%$ except from 5 to 15 MHz where it is $\approx 15\%$. **NOISE:** Carrier noise level corresponds to $\approx 0.1\%$ modulation.

Rf Output: **ATTEN OUTPUT:** 0.1 μV to 200 mV open circuit (0.5 μV to 100 mV across 50- Ω load*). **ACCURACY:** $\pm(6\% + 0.1 \mu\text{V})$ from 150 kHz to 10 MHz with output dial near full

* Providing that the 1000-P2 40- Ω Series Unit is plugged into the output connector, but removed whenever the Multiplier (attenuator) is set for maximum output.

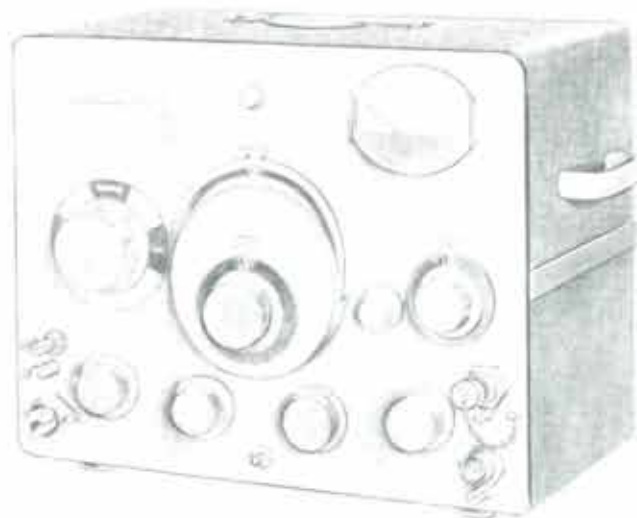

scale or 1/10 full scale, additional $\pm 4\%$ at midscale; $\pm(10\% + 0.3 \mu\text{V})$ above 10 MHz near full-scale output, additional $\pm 10\%$ at other output-dial settings. **SOURCE IMPEDANCE:** 50 Ω^* (10 Ω , without the 40 Ω in series, at most positions of the Multiplier). 1000-P4 Dummy Antenna provides standard (IEEE) test impedance; 1000-P10 Test Loop provides known induction field for testing loop receivers. **2-VOLT OUTPUT:** 2 V open circuit up to 15 MHz, when output meter is set to reference mark; accuracy, $\pm 3\%$ at mid frequencies. Source impedance, 300 Ω .

Terminals: Rf output from 2 ports labeled Atten and 2 Volts. Each port is a locking GR874 connector with grounded binding post at standard spacing, so that dual banana plugs are also accommodated. Short-circuit termination (supplied) normally seals the unused port.

Environment: **LEAKAGE:** $< 1 \mu\text{V}$ per meter, 2 ft from generator, at 1 MHz.

Supplied: GR874-to-GR874 patch cord, 1000-P1 50- Ω m Termination Unit, 1000-P2 40- Ω m Series Unit, 874-Q2 Adaptor, TO-44 Adjustment Tool, 274-MB plug, power cord.

Power: 105 to 125, 195 to 235, or 210 to 250 V, 40 to 60 Hz (115 to 125 V to 400 Hz), 65 W max.

Mechanical: Lab-Bench Cabinet. **DIMENSIONS (wxhxd):** 20.25x13.75x11 in. (514x349x279 mm). **WEIGHT:** 54 lb (25 kg) net, 67 lb (31 kg) shipping.

Description	Catalog Number
1001-A Standard-Signal Generator	1001-9701

Standard-Signal-Generator Accessories

1000-P10 TEST LOOP

3 MHz max. For testing radio receivers with loop antennas in accordance with ANSI C16.19-1951. The 3-turn loop is enclosed in aluminum tubing for electrostatic shielding. Field strength in V/meter, 19 in. from loop, is 1/10 generator output in V, with a 50- Ω generator. Accuracy with 1001-A is $\pm 15\%$ ($\approx 10\%$ typical). **DIMENSIONS (wxhxd):** 11.75x16.5x3.5 in. (298x419x90 mm). **WEIGHT:** 4.5 lb (2.1 kg) net, 6 lb (2.8 kg) shipping.



1000-P4 DUMMY ANTENNA

Provides the output characteristics specified by IEEE in "Standards on Radio Receivers, Methods of Testing Amplitude-Modulation Broadcast Receivers," 1948 (now ANSI Standard

C16.19-1951). **DIMENSIONS:** 4.38 in. long x 0.88 in. dia (111x22 mm). **WEIGHT:** 0.25 lb (0.1 kg) net, 1 lb (0.5 kg) shipping.

1000-P5 VHF TRANSFORMER

50 to 220 MHz. Produces an equal, balanced, open-circuit voltage behind a 300- Ω balanced impedance for measurements of fm and TV receivers. Plugs into a 50- Ω standard-signal generator; one terminal fits an Alden HA-902P Connector for standard 300- Ω line, the other a GR874[®] connector. **DIMENSIONS:** 4.38 in. long x 0.88 in. dia (111x22 mm). **WEIGHT:** 0.25 lb (0.1 kg) net, 1 lb (0.5 kg) shipping.

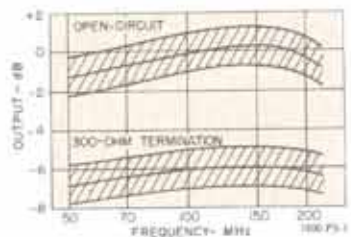

Description	Catalog Number
1000-P4 Dummy Antenna	1000-9604
1000-P5 VHF Transformer (to balanced 300 Ω)	1000-9605
1000-P10 Test Loop	1000-9610

* Federal stock numbers are listed before the Index.

GR874®

Broad-Band Coaxial Components

The GR874® components are available in 50 Ohm and 75 Ohm impedances in the following configurations:

50 Ohm Components

• Tee, T-junction and branching adapters
• 180° Rotators

• Couplers (1:1 and 1:4) and isolation pads
• Attenuators

Connectors and Adapters for 50 Ohm Systems

• SMA, SMA-F, SMA-Female, SMA-Female
• SMA-Female and SMA-Female
• SMA-Female to SMA-Female

Connectors and Adapters

• SMA-Female to SMA-Female

50 Ohm Connector Systems

• SMA-Female to SMA-Female
• SMA-Female to SMA-Female

• SMA-Female to SMA-Female
• SMA-Female to SMA-Female

75 Ohm Components

• Tee, T-junction and branching adapters

• 180° Rotators

• Couplers (1:1 and 1:4) and isolation pads
• Attenuators

Connectors and Adapters for 75 Ohm Systems

• SMA-Female to SMA-Female

• SMA-Female to SMA-Female



GR874® General-Purpose Coaxial Components

Over 24 years of design refinement General Radio entered the coaxial component field over 24 years ago with the introduction of the GR874® connector. This connector offered not only excellent electrical performance but a major convenience feature — any two, although identical, could be mated. The hermaphrodite, quick-connect GR874 connector was soon joined by a family of circuit elements and adaptors using it. GR874-equipped instruments were added to solve the special measurement problems of vhf and uhf and the availability of these precise measuring instruments in turn made possible a continuous refinement of the basic connector.

A universal choice The GR874 connector has gained wide popularity; highly respected instrument manufacturers have put the electrical and physical advantages of these connectors to good use on their products.

Based on the GR874 connector is a full line of coaxial components and instruments so that a user of the GR874-equipped laboratory need seldom turn to other connector types for a needed element. If he does, there are GR874 adaptors to fit most other common types of connector.

Locking connectors The GR874 connector is available in both the common nonlocking version and a high-performance locking version. The locking version has a threaded coupling nut that permits the two connectors to be mechanically locked together in a stable, semi-permanent union for better electrical repeatability, lower leakage, and less chance of accidental disconnection. The quick-connect/disconnect feature is retained if the coupling nut is not engaged.

Electrical characteristics The GR874 connector has truly outstanding reflection characteristics among standard, general-purpose coaxial connectors in the dc-to-9 GHz frequency range. Its SWR performance is typically superior to that of the type N connector, for example. Its low level of reflections at high frequencies makes the connector of particular value in pulse applications and in time-domain reflectometry. GR874 cable connectors, in fact, offer SWR performance superior to that of any cable with which they can be used and therefore add no significant reflections when used in cabled measurement set-ups. They also provide very low contact resistance, an important requirement to minimize intermodulation in multichannel communications systems.

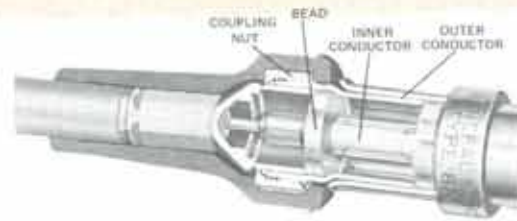

Cutaway view of GR874 basic connector mated with GR874 cable connector.

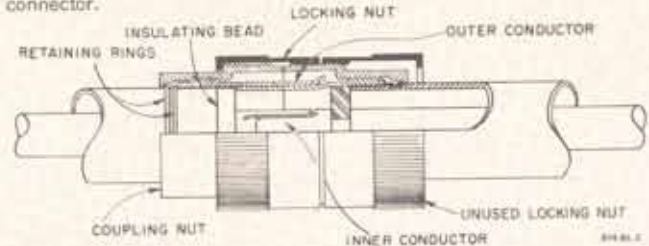

Mechanical characteristics The elements of a GR874 connector include an inner conductor, an outer conductor, a supporting polystyrene bead, a phosphor-bronze retaining ring, and a threaded coupling nut. All metal parts are machined and formed to very close tolerances; all are made of hard-drawn brass, except for the center conductor which is heat-treated beryllium copper to ensure good gripping capability and long wear. A bright-alloy finish on all surfaces produces good conductivity for low loss and gives long-lasting protection against tarnish.

Inner and outer conductors are similar in principle; each is a tube with four longitudinal slots in one end, with two opposite quadrants displaced inward. When two connectors are joined, the undisplaced quadrants of one overlap the displaced quadrants of the other.

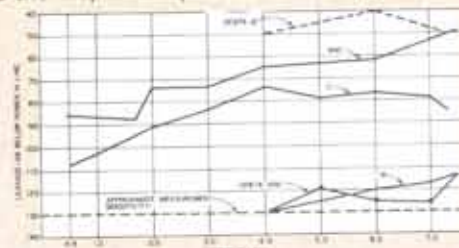

Leakage — note advantage of locking version (B74-BBL).

GR874® 50-Ohm Connectors

Basic Connectors

For use on rigid, 14-mm, air-dielectric 50- Ω coaxial lines or with capacitance, inductance, and resistance standards.

Frequency: Dc to 9 GHz.

Electrical: IMPEDANCE: 50 Ω . INPUT VOLTAGE: Up to 1500 V pk. POWER, average into 50- Ω load: Up to 40 kW, dc to 50 kHz, decreasing as $1/\sqrt{f}$ to 0.1 kW at 10 GHz.

Mechanical: DIMENSIONS: Non-locking, 1.19 in. (30 mm) x 0.813 in. (21 mm) dia; locking, same length x 1 in. (25 mm) dia. WEIGHT: 0.2 lb (0.1 kg) net, 1 lb (0.5 kg) shipping.

Description

Catalog Number

Basic 50- Ω Connector
874-B, non-locking
874-BBL, locking

0874-9400
0874-9403



non-locking



locking



Typical SWR of pairs of connectors.

Cable Connectors

For use with more than 40 different RG types of coaxial cable. Each cable connector consists of a basic connector, plus inner and outer transition pieces, a soft copper ferrule, a heat disk, and a flexible cable guard. The transition pieces maintain the 50-ohm characteristic impedance of the connector throughout the reduction to the cable diameter. The cable inner conductor is soldered to the inner transition piece; the cable braid and jacket are crimped to the outer transition by the specially perforated ferrule. Braid and jacket are thus securely fastened, to minimize reflections and leakage. A neoprene cable guard serves as a protective handle. Sized to grip the cable securely without compressing it, the cable guard adds to the quick-connect/disconnect convenience of the connector.

Frequency: Dc to 7.5 GHz.

Electrical: IMPEDANCE: 50 Ω . INPUT VOLTAGE, peak: For A (874-CA, -CLA, -C8A, -CL8A): Up to 1000 V; for B (874-C58A, -CL58A, -C62A, -CL62A): Up to 500 V; for C (874-C174A, -CL174A): Up to 300 V. POWER, average into 50- Ω load: For A, up to 20 kW, dc to 100 kHz, decreasing as $1/\sqrt{f}$ to 0.1 kW at 5 GHz; for B, up to 5 kW, dc to 500 kHz, decreasing as $1/\sqrt{f}$ to 0.1 kW at 1 GHz; for C, up to 1.8 kW, dc to 300 kHz, decreasing as $1/\sqrt{f}$ to 0.1 kW at 80 MHz.

Mechanical: DIMENSIONS: 2.69 in. (68 mm) long x 1 in. (25 mm) dia. WEIGHT: 0.2 lb (0.1 kg) net, 1 lb (0.5 kg) shipping.



non-locking

locking

Panel Connectors

For use on equipment panels. Connectors are available to fit the five popular cable sizes and wire leads. They are mounted to a panel by means of a flange and four screws; the non-locking connector can be mounted either front or back. The recessed connectors protrude forward only 0.13 in. (3.2 mm), for space saving and neatness.

Electrical: IMPEDANCE: 50 Ω . INPUT VOLTAGE, peak: For A (874-PB8, -PLA, -PRLA, -PB8A, -PL8A, -PRL8A): Up to 1000 V; for B (874-PB58A, -PL58A, -PRL58A, -PB62A, -PL62A, -PRL62A): Up to 500 V; for C (874-PB174A, -PL174A, -PRL174A): Up to 300 V; for D (874-PLT, -PRLT): Up to 1500 V. POWER, average into 50- Ω load: For A, up to 20 kW, dc to 100 kHz, decreasing as $1/\sqrt{f}$ to 0.1 kW at 5 GHz; for B, up to 5 kW, dc to 500 kHz, decreasing as $1/\sqrt{f}$ to 0.1 kW at 1 GHz; for C, up to 1.8 kW, dc to 300 kHz, decreasing as $1/\sqrt{f}$ to 0.1 kW at 80 MHz; for D, up to 40 kW, dc to 50 kHz, decreasing as $1/\sqrt{f}$ to 0.1 kW at 10 GHz.

Mechanical: WEIGHT: 0.2 lb (0.1 kg) net, 1 lb (0.5 kg) shipping.



non-locking

locking

recessed

Panel Feedthrough Connector

Mates any pair of GR874 connectors directly through a panel or wall. Can be mounted as recessed or nonrecessed panel locking connector. Can be mounted through thick bulkheads 0.25 to 2 inches (51 mm), or more, in thickness by counterboring.

Electrical: IMPEDANCE: 50 Ω , nominal. INPUT VOLTAGE: Up to 1500 V pk. POWER, average into 50- Ω load: Up to 40 kW, dc to 50 kHz, decreasing as $1/\sqrt{f}$ to 0.1 kW at 10 GHz.

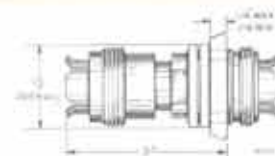

874-PFL Panel Feedthrough Connector

0874-9451

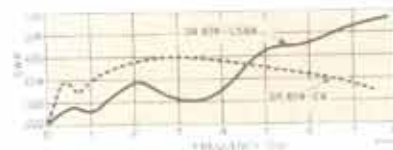

Average SWR of single connector on infinite length of 50-ohm cable.

Description	Catalog Number
50-Ω Cable Connectors:	
For GR 874-A2 Cable:	
874-CA, non-locking	0874-9410
874-CLA, locking	0874-9411
For 50- Ω cable including RG-8A/U, -9B/U, -10A/U, -87A/U, -116/U, -156/U, -165/U, -166/U, -213/U, -214/U, -215/U, -225/U, -227/U, and non-50- Ω cable including RG-11A/U, -12A/U, -13A/U, -63B/U, -79B/U, -89/U, -144/U, -146/U, -149/U, -216/U:	
874-C8A, non-locking	0874-9412
874-CL8A, locking	0874-9413
For 50- Ω cable including GR 874-A3, RG-29/U, -55/U series, -58A/U series, -141A/U, -142A/U, -159/U, -23/U:	
874-C58A, non-locking	0874-9414
874-CL58A, locking	0874-9415
For non-50- Ω cable including RG59/U, -62/U series, -71B/U, -140/U, -210/U:	
874-C62A, non-locking	0874-9416
874-CL62A, locking	0874-9417
For 50- Ω cable including RG-174/U, -188/U, -316/U, and non-50- Ω cable including RG-161/U, -187/U, -179/U:	
874-C174A, non-locking	0874-9418
874-CL174A, locking	0874-9419

50- Ω Panel Connectors:

For GR 874-A2 Cable:	
874-PBA, non-locking	0874-9440
874-PLA, locking	0874-9441
874-PRLA, recessed locking	0874-9461
For 50- Ω Cable including RG-8A/U, -9B/U, -10A/U, -87A/U, -116/U, -156/U, -165/U, -166/U, -213/U, -214/U, -215/U, -225/U, -227/U, and non-50- Ω cable including RG-11A/U, -12A/U, -13A/U, -63B/U, -79B/U, -89/U, -144/U, -149/U, -216/U:	
874-PB8A, non-locking	0874-9442
874-PL8A, locking	0874-9443
874-PRL8A, recessed locking	0874-9463
For 50- Ω cable including GR 874-A3, RG-29/U, -55/U series, -58/U series, -141A/U, -142/U, -159/U, -23/U:	
874-PB58A, non-locking	0874-9444
874-PL58A, locking	0874-9445
874-PRL58A, recessed locking	0874-9465
For non-50- Ω cable including RG59/U, -62/U series, -71B/U, -140/U, -210/U:	
874-PB62A, non-locking	0874-9446
874-PL62A, locking	0874-9447
874-PRL62A, recessed locking	0874-9467
For 50- Ω cable including RG-174/U, -188/U, -316/U, and non-50- Ω cable including RG-161/U, -187/U, -179/U:	
874-PB174A, non-locking	0874-9448
874-PL174A, locking	0874-9449
874-PRL174A, recessed locking	0874-9469
For Wire Leads:	
874-PLT, locking	0874-9459
874-PRLT, recessed locking	0874-9479

GR874® 50-Ohm Adaptors

Conversion These adaptors provide easy conversion from the GR874® connector to most popular military and industrial coaxial connectors. Many of the adaptors are available with locking GR874 connectors to allow semi-permanent attachment of the adaptor while ensuring stable electrical performance.

Without degradation GR874 adaptors extend the usefulness of GR874 connectors without sacrificing electrical performance. The SWR of the combination of GR874 connector and GR874 adaptor is actually comparable to that of the "other series" connector alone.

Excellent for OEM applications Original-equipment manufacturers recognize the possibilities of these adap-

tors in combination with the GR874 recessed panel connector. An instrument originally equipped with these connectors can be quickly converted by means of appropriate GR874 adaptors to almost any coaxial connector series; the resulting panel connector protrudes less than an inch in front of the panel.

Replace countless adaptors Because any two GR874 adaptors mate, a few of them can perform a cross-connection task that would otherwise involve a costly collection of direct adaptors. For example, interconnection of types BNC, C, Microdot, N, TNC, and UHF plugs and jacks would require 72 direct adaptors, whereas only 12 GR874 adaptors are needed to do the same job.

50-Ohm Adaptor Kit

- fifteen adaptors in one neat package provide the answer to the connector dilemma

Tame the connector menagerie Your device is fitted with type N connectors, your test equipment with UHF, and your patch cords with BNC — is that what plagues you? Or have you just wasted ten minutes trying to force one SMA plug onto another? Frustrating as these experiences may be, they're inevitable because of the multitude of connector types available to manufacturers. There is a bright side, however, and it comes in the form of a small gray box from General Radio. The box contains 15 different adaptor types that allow you to connect to any of 9 popular commercial and military connector types — conveniently and with a minimum of the usual fumbling.

With a double approach All adaptors in the kit have one connector type in common, the GR874. These connectors are hermaphroditic; i.e., any two, although identical, can be plugged together — no more worrying about whether you need a jack or a plug or whatever.

One approach to the problem is simply to connect the appropriate adaptor to each end of a GR874® patch cord and then connect it from one device to the other.

Equally simple is a second approach. Connect one adaptor to another, with the second adaptor appropriate to whatever type of patch cord you have available.

Supplied: In addition to the adaptors listed below, the kit also includes one 874-T tee connector to connect stubs and other elements in shunt with a coaxial line, one 874-EL 90° ell right-angle line section, and one 874-R33 three-foot 50-Ω cable terminated on one end with a GR874 connector and on the other with banana plugs.

Qty	Contains GR874 and	GR Type	Qty	Contains GR874 and	GR Type
2	BNC jack	874-QBJA	1	SMA jack	874-QMMJ
2	BNC plug	874-QBPA	1	SMA plug	874-QMMP
1	C jack	874-QCJA	1	TNC jack	874-QTNJ
1	C plug	874-QCP	1	TNC plug	874-QTNP
1	HN jack	874-QHJA	2	UHF jack	874-QUJ
1	HN plug	874-QHPA	2	UHF plug	874-QUP
3	N jack	874-QNJA	1	banana jacks	874-Q2
3	N plug	874-QNP		(See also preceding paragraph.)	

Mechanical: All components housed in a rugged steel case with piano hinge, 2 clasps, and carrying handle. DIMENSIONS: (wxhxd): 18.5x4x7 in. (470x102x178 mm). WEIGHT: 4.5 lb (2.1 kg) net, 6 lb (2.8 kg) shipping.

Description	Catalog Number
874-9099 Adaptor Kit	0874-9099



GR874® 50-Ohm Adaptors (Refer also to Types 274, 776, and 777.)

Adaptors to BNC

Four adaptors are available; two include a BNC jack with either a non-locking or a locking GR874 connector, and two include a BNC plug with either a non-locking or a locking GR874 connector.

Frequency: Dc to 8.5 GHz.

Electrical: IMPEDANCE: 50 Ω , nominal. INPUT VOLTAGE: Up to 500 V pk. POWER, average into 50- Ω load: Up to 5 kW, dc to 500 kHz, decreasing as $1/\sqrt{f}$ to 0.1 kW at 1 GHz.

Mechanical: WEIGHT: 0.2 lb (0.1 kg) net, 1 lb (0.5 kg) shipping.



874-QBJA



874-QBPA

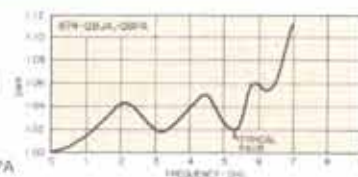

Description	Catalog Number
50-Ω Adaptors to BNC	
874-QBJA, BNC jack, non-locking GR874 connector	0874-9700
874-QBJL, BNC jack, locking GR874 connector	0874-9701
874-QBPA, BNC plug, non-locking GR874 connector	0874-9800
874-QBPAL, BNC plug, locking GR874 connector	0874-9801

Adaptors to C

Three adaptors are available; two include a type C jack with either a non-locking or a locking GR874 connector, and one includes a type C plug with a non-locking GR874 connector.

Frequency: Dc to 8.5 GHz.

Electrical: IMPEDANCE: 50 Ω nominal. INPUT VOLTAGE: Up to 1000 V pk. POWER, average into 50- Ω load: Up to 20 kW, dc to 100 kHz, decreasing as $1/\sqrt{f}$ to 0.1 kW at 5 GHz.

Mechanical: WEIGHT: 0.2 lb (0.1 kg) net, 1 lb (0.5 kg) shipping.



874-QCJA



874-QCP

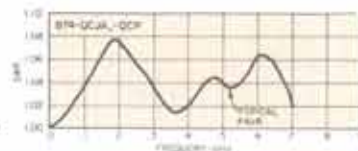

Description	Catalog Number
50-Ω Adaptors to C	
874-QCJA, C jack, non-locking GR874 connector	0874-9702
874-QCJL, C jack, locking GR874 connector	0874-9703
874-QCP, C plug, non-locking GR874 connector	0874-9802

Adaptors to HN

Two adaptors are available; one includes a type HN jack and the other includes a type HN plug. Each uses a GR874 non-locking connector on the other end.

Frequency: Dc to 8.5 GHz.

Electrical: IMPEDANCE: 50 Ω , nominal. INPUT VOLTAGE: Up to 1500 V pk. POWER, average into 50- Ω load: Up to 40 kW, dc to 50 kHz, decreasing as $1/\sqrt{f}$ to 0.1 kW at 10 GHz.

Mechanical: WEIGHT: 0.2 lb (0.1 kg) net, 1 lb (0.5 kg) shipping.



QHJA



QHPA

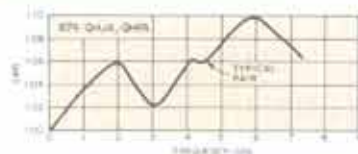

Description	Catalog Number
50-Ω Adaptors to HN	
874-QHJA, HN jack, non-locking GR874 connector	0874-9704
874-QHPA, HN plug, non-locking GR874 connector	0874-9804

Adaptors to Microdot

Three adaptors are available; two include a Microdot jack with either a non-locking or a locking GR874 connector, and one includes a Microdot plug with a non-locking GR874 connector.

Frequency: Dc to 4 GHz.

Electrical: IMPEDANCE: 50 Ω , nominal. INPUT VOLTAGE: Up to 300 V pk. POWER, average into 50- Ω load: Up to 1.8 kW, dc to 300 kHz, decreasing as $1/\sqrt{f}$ to 0.1 kW at 80 MHz.

Mechanical: WEIGHT: 0.2 lb (0.1 kg) net, 1 lb (0.5 kg) shipping.



874-QMDJ



874-QMDP

Description	Catalog Number
50-Ω Adaptors to Microdot	
874-QMDJ, Microdot jack, non-locking GR874 connector	0874-9720
874-QMDJL, Microdot jack, locking GR874 connector	0874-9721
874-QMDP, Microdot plug, non-locking GR874 connector	0874-9820

⊕ Federal stock numbers are listed before the index.

GR874® 50-ohm Adaptors (Cont'd)

Adaptors to N

Four adaptors are available; two include a type N jack with either a non-locking or a locking GR874 connector, and two include a type N plug with either a non-locking or a locking GR874 connector.

Frequency: Dc to 8.5 GHz.

Electrical: IMPEDANCE: 50 Ω , nominal. INPUT VOLTAGE: Up to 1000 V pk. POWER, average into 50- Ω load: Up to 20 kW, dc to 100 kHz, decreasing as $1/\sqrt{f}$ to 0.1 kW at 5 GHz.

Mechanical: WEIGHT: 0.2 lb (0.1 kg) net, 1 lb (0.5 kg) shipping.

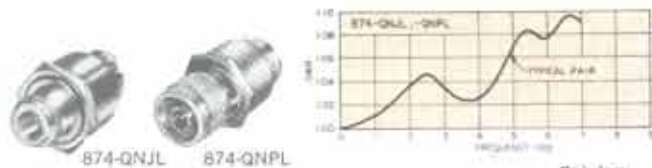

Description

Catalog Number

50- Ω Adaptors to N

874-QNJA, N jack, non-locking GR874 connector	↔	0874-9710
874-QNJL, N jack, locking GR874 connector	↔	0874-9711
874-QNP, N plug, non-locking GR874 connector	↔	0874-9810
874-QNPL, N plug, locking GR874 connector	↔	0874-9811

Adaptors to SMA

Four adaptors are available; two include an SMA jack with either a non-locking or a locking GR874 connector, and two include an SMA plug with either a non-locking or a locking GR874 connector. These adaptors also mate with NPM, STM, and others.

Frequency: Dc to 8.5 GHz.

Electrical: IMPEDANCE: 50 Ω , nominal. INPUT VOLTAGE: Up to 300 V pk. POWER, average into 50- Ω load: Up to 1.8 kW, dc to 300 kHz, decreasing as $1/\sqrt{f}$ to 0.1 kW at 80 MHz.

Mechanical: WEIGHT: 0.2 lb (0.1 kg) net, 1 lb (0.5 kg) shipping.



50- Ω Adaptors to SMA

874-QMMJ, SMA jack, non-locking GR874 connector	↔	0874-9722
874-QMMJL, SMA jack, locking GR874 connector	↔	0874-9723
874-QMMP, SMA plug, non-locking GR874 connector	↔	0874-9822
874-QMMP, SMA plug, locking GR874 connector	↔	0874-9823

Adaptors to TNC

Three adaptors are available; two include a TNC jack with either a non-locking or locking GR874 connector, and one includes a TNC plug with a non-locking GR874 connector.

Frequency: Dc to 8.5 GHz.

Electrical: IMPEDANCE: 50 Ω , nominal. INPUT VOLTAGE: Up to 500 V pk. POWER, average into 50- Ω load: Up to 5 kW, dc to 500 kHz, decreasing as $1/\sqrt{f}$ to 0.1 kW at 1 GHz.

Mechanical: WEIGHT: 0.2 lb (0.1 kg) net, 1 lb (0.5 kg) shipping.



Description

Catalog Number

50- Ω Adaptors to TNC

874-QTNJ, TNC jack, non-locking GR874 connector	↔	0874-9716
874-QTNJL, TNC jack, locking GR874 connector	↔	0874-9717
874-QTNP, TNC plug, non-locking GR874 connector	↔	0874-9816

Adaptors to UHF

Three adaptors are available; two include a UHF jack with either a non-locking or a locking GR874 connector, and one includes a UHF plug with a non-locking GR874 connector.

Electrical: IMPEDANCE: 50 Ω , nominal. INPUT VOLTAGE: Up to 500 V pk. POWER, average into 50- Ω load: Up to 5 kW, dc to 500 kHz, decreasing as $1/\sqrt{f}$ to 0.1 kW at 1 GHz.

Mechanical: WEIGHT: 0.2 lb (0.1 kg) net, 1 lb (0.5 kg) shipping.



50- Ω Adaptors to UHF

874-QUJ, UHF jack, non-locking GR874 connector	↔	0874-9718
874-QUJL, UHF jack, locking GR874 connector	↔	0874-9719
874-QUP, UHF plug, non-locking GR874 connector	↔	0874-9818

Adaptor to 7-mm Precision

One adaptor is available and includes an Amphenol APC-7, 7-mm precision, connector on one end and a locking GR874 connector on the other end.

Frequency: Dc to 8.5 GHz.

Electrical: IMPEDANCE: 50 Ω , nominal. INPUT VOLTAGE: Up to 1000 V pk. POWER, average into 50- Ω load: Up to 20 kW, dc to 100 kHz, decreasing as $1/\sqrt{f}$ to 0.1 kW at 5 GHz.

Mechanical: WEIGHT: 0.2 lb (0.1 kg) net, 1 lb (0.5 kg) shipping.



50- Ω Adaptor to 7-mm Precision

874-QAP7L, Amphenol APC-7, locking GR874 connector	↔	0874-9791
--	---	-----------

↔ Federal stock numbers are listed before the Index.

Adaptor to GR900® Connector

One adaptor is available and includes a GR900 precision connector on one end and a locking GR874 connector on the other end.

Frequency: Dc to 8.5 GHz.

Electrical: IMPEDANCE: 50 Ω , nominal. INPUT VOLTAGE: Up to 1500 V pk. POWER, average into 50- Ω load; Up to 40 kW, dc to 50 kHz, decreasing as $1/\sqrt{f}$ to 0.1 kW at 10 GHz.

Mechanical: WEIGHT: 0.2 lb (0.1 kg) net, 1 lb (0.5 kg) shipping.

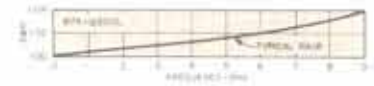

Description

Catalog Number

50- Ω Adaptor to GR900
874-Q900L, GR900 and locking; GR874 Connectors

0874-9709

Adaptor to Binding Posts

One adaptor is available and includes a pair of 0.75-in.-spaced binding posts on one end and a non-locking GR874 connector on the other end. Mates with banana plugs. (Note: A single post is also available, on the 874-MB Coupling Probe.)

Mechanical: WEIGHT: 0.2 lb (0.1 kg) net, 1 lb (0.5 kg) shipping.



50- Ω Adaptor to binding post

874-Q2, jacks, non-locking GR874 connector

0874-9870

Adaptors to Banana Plugs

Two adaptors are available; each includes a pair of 0.75-in.-spaced banana plugs and a non-locking GR874 connector on the other end. One adaptor is completely shielded; the other has unshielded banana plugs.

Mechanical: WEIGHT: 0.2 lb (0.1 kg) net, 1 lb (0.5 kg) shipping.



50- Ω Adaptors to banana plugs

777-Q3, shielded plugs
874-Q10, unshielded plugs

0777-9703
0874-9876

Balun

This is a tuned coaxial 4:1 transformer that matches 50- Ω coaxial line to 200- Ω balanced line and thus extends the usefulness of generally available coaxial instruments to balanced devices. Used with a slotted line, network analyzer, admittance meter, or transfer-function and impedance bridge, the balun permits measurements on balanced components over a frequency range from 54 MHz to 1 GHz without appreciable insertion loss or transformation error.

Tuning: 54 MHz to 1 GHz with following accessories (not supplied):

Frequency	Tuning Elements Required
54 to 88 MHz	Two 874-VCL and two 874-XL
88 to 140 MHz	Two 874-VCL and two 874-L30
140 to 174 MHz	Two 874-VCL and two 874-L20
174 to 216 MHz	Two 874-VCL and two 874-L10
170 to 280 MHz	Two 874-D50L and two 874-L30
225 to 280 MHz	Two 874-D20L and two 874-L30
275 to 380 MHz	Two 874-D20L and two 874-L20
350 to 525 MHz	Two 874-D20L and two 874-L10
470 to 1000 MHz	Two 874-D20L

Supplied: 874-UB-P1 300- Ω Terminal, 874-WN3 Short-Circuit Termination, 874-WO3 Open-Circuit Termination.

Recommended: 874-LK20L Adjustable Line (for use with 1602-B UHF Admittance Meter), one 874-Z Stand, and appropriate tuning elements as listed in the table.

874-UB-P2 200-Ohm Terminal Unit: Connects balun directly to 200- Ω transmission line or to balanced components via screw terminals. FREQUENCY: Dc to 1 GHz. IMPEDANCE: 200 Ω . SWR: 1.2 to 300 MHz, 1.3 to 1 GHz. TRANSMISSION LINE: RG-85/U recommended.

874-UB-P3 300-Ohm Terminal Pad: Converts the 200- Ω balanced output impedance, characteristic of the balun, to 300 Ω . Facilitates power and voltage measurements on balanced 300- Ω systems with signal generators and detectors designed for use with 50- Ω coaxial circuits.

Mechanical: DIMENSIONS (wxhxd): -UBL, 3.13x3.38x2.38 in. (79x86x60 mm); -P2 or -P3, 1x1.75x2.2 in. (25x44x56 mm). NET WEIGHT: -UBL, 1.3 lb (0.6 kg); -P2 or -P3, 0.6 oz (17 g).

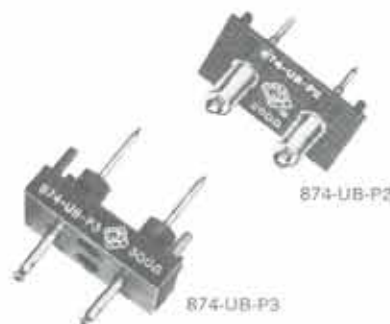
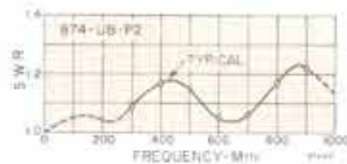

874-UBL Balun with two Stubs and one 874-Z Stand.



874-UBL Balun
874-UB-P2 200-Ohm Terminal Unit
874-UB-P3 300 Ohm Terminal Pad

0874-9921
0874-9923
0874-9924

GR874® Terminations and Attenuators for 50-Ohm Systems

Short-Circuit Terminations

Short-circuit terminations are useful in establishing initial coaxial line-length conditions for impedance measurements. Each termination consists of a fixed short-circuit mounted in a GR874 connector. Each of three versions has a counterpart open-circuit termination.

Frequency: Dc to 7 GHz; to 9 GHz if connector is locked.

Plane Position: Short-circuit plane is effectively 0 to 0.07 cm toward load from the generator face of bead, except in -WN3 where it is 3.2 cm (see drawing). (3.2 cm correspond to the bead-to-reference-plane distance in 874-ML Component Mount and 874-UBL Balun).

Description	Catalog Number
Short-Circuit Terminations for 50-Ω Lines	
874-WN, non-locking GR874 connector	0874-9970
874-WNL, locking GR874 connector	0874-9971
874-WN3, non-locking GR874 connector	0874-9972

Mechanical: WEIGHT: 0.2 lb (0.1 kg) net, 1 lb (0.5 kg) shipping.

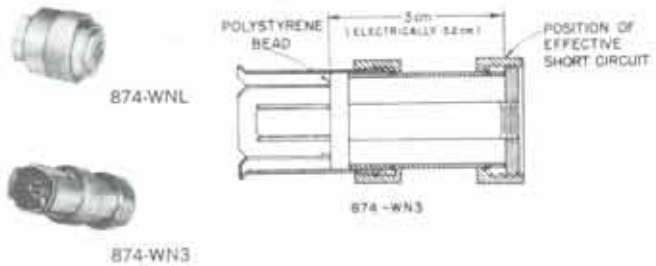

Open-Circuit Terminations

Open-circuit terminations are useful in establishing initial coaxial line-length conditions for impedance measurements and as a shielding cap for open-circuited lines.

Frequency: Dc to 7 GHz; to 9 GHz if locked.

Plane Position (effective position of open-circuit plane, measured from generator face of bead, toward load): 0 to 0.05 cm, for 874-WO; 0 to 0.10 cm, for -WOL, see curve; 3.2 cm, for -WO3, see drawing. The latter position corresponds to that of the short-circuit plane in the 874-WN3 (3.2 cm also correspond to the bead-to-reference-plane distance in 874-ML Component Mount and 874-UBL Balun).

Mechanical: WEIGHT: 0.2 lb (0.1 kg) net, 1 lb (0.5 kg) shipping.

Description	Catalog Number
Open-Circuit Terminations for 50-Ω Lines	
874-WO, non-locking GR874 connector	0874-9980
874-WOL, locking GR874 connector	0874-9981
874-WO3, non-locking GR874 connector	0874-9982

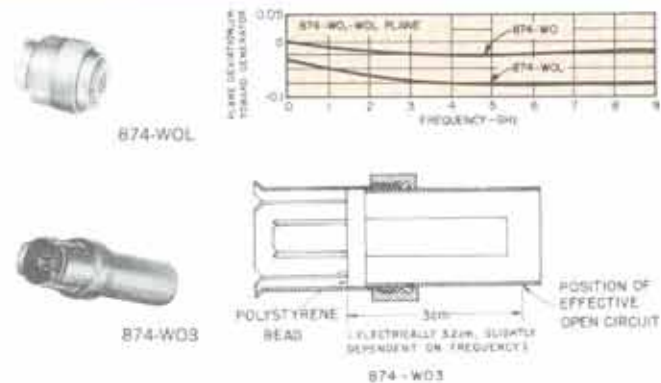

Resistive Terminations

Resistive terminations are useful in slotted-line measurements and for checking accuracy of network analyzers, directional couplers, bridges, and admittance meters. The known location of a purely resistive termination permits the production of sections of 874-L Air Line, fixed or adjustable.

Frequency: Dc to 9 GHz for -W50B and -W50BL; dc to 2 GHz for -W100 and -W200.

Dc Resistance: 50 Ω ± 0.5% for -W50B and -W50BL; 100 Ω ± 1% for -W100; 200 Ω ± 1% for -W200.

Electrical: POWER, max continuous: 2 W for -W50B and -W50BL, 0.35W for -W100, 0.25 W for -W200. SWR: < 1.005 + 0.013 f_{GHz} for -W50B and -W50BL; also see curves.

Mechanical: WEIGHT: 0.2 lb (0.1 kg) net, 1 lb (0.5 kg) shipping.

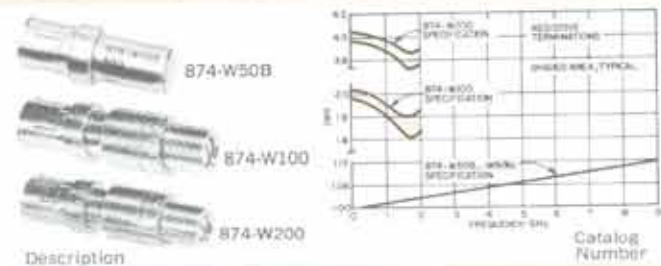

Description	Catalog Number
Resistive Terminations for 50-Ω Lines	
874-W50B, 50 Ω, non-locking GR874 connector	0874-9954
874-W50BL, 50 Ω, locking GR874 connector	0874-9955
874-W100, 100 Ω, non-locking GR874 connector	0874-9956
874-W200, 200 Ω, non-locking GR874 connector	0874-9958

Adjustable Stubs

For matching or tuning, for use as adjustable short-circuit terminations, and as reactive elements. With an external indicator, the stub can function as a reaction-type wavemeter. Stub consists of a coaxial line with a sliding short circuit of the multiple-spring-finger type.

Frequency: Dc to 8.5 GHz.

Length: 874-D20L: 20 cm max travel, calibrated in electrical distance from junction in 874-T tee to plane of short circuit. 874-D50L: 50 cm max travel, not calibrated but has an adjustable reference marker.

Electrical: IMPEDANCE: 50 Ω, nominal.
Mechanical: NET WEIGHT: 874-D20L, 0.5 lb (0.2 kg); 874-D50L, 0.9 lb (0.4 kg).

Description	Catalog Number
Adjustable Stubs for 50-Ω Lines	
874-D20L, 20 cm, locking GR874 connector	0874-9511
874-D50L, 50 cm, locking GR874 connector	0874-9513

† Federal stock numbers are listed before the Index.

Variable Capacitor

Tuning element for resonant-line circuits, matching transformers, and baluns at low frequencies where line-type elements are awkward to use. Well shielded, Rexolite[®] insulation, precision ball bearings. Linear capacitance variation.

Frequency: <500 MHz, typical.

Capacitance at low frequencies: 14 to 70 pF at connector, 16.5 to 72.5 pF at junction of 874-T Tee. Refer to graph.

Mechanical: DIMENSIONS: 5.25 in. (133 mm) long x 2.5 in. (64 mm) dia. WEIGHT: 0.8 lb (0.4 kg) net.

[®] Registered trademark of Brand Rex Division, American Enka Corporation.

Description	Catalog Number
874-VCL Variable Capacitor, with locking GR874 connector	0874-9931

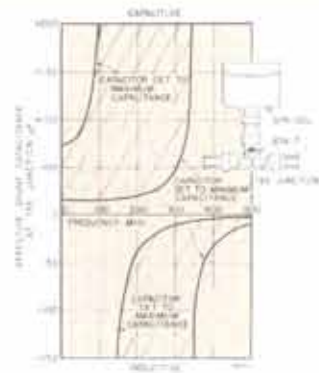

Fixed Attenuators

Single-section, F type resistance pads, for insertion of fixed attenuation in 50-ohm systems and for isolation and matching to 50 ohms over a broad frequency range. Each attenuator consists of one disk and two cylindrical resistors, as shunt and series elements respectively. The 6-, 14-, and 20-dB attenuators are particularly convenient in pulse applications as voltage dividers.

Frequency: Dc to 4 GHz.

Attenuation Accuracy (relative to correction curves shown): ± 0.2 dB, dc to 1 GHz; ± 0.4 dB, to 2 GHz; ± 0.6 dB, to 4 GHz. TEMPERATURE COEFFICIENT: <0.0003 dB/°C/dB.

Electrical: DC RESISTANCE: 50 $\Omega \pm 1\%$ when terminated in 50 Ω . INPUT POWER, max: 1 W cw or average; 2 kW peak, pulsed.

Mechanical: DIMENSIONS: 3.5 in. (89 mm) long. WEIGHT: 0.2 lb (0.1 kg) net, 1 lb (0.5 kg) shipping.

50- Ω Fixed Attenuators*

874-G3, 3 dB ± 0.045 dB, non-locking	0874-9564
874-G3L, 3 dB ± 0.045 dB, locking	0874-9565
874-G6, 6 dB ± 0.09 dB (X2), non-locking	0874-9568
874-G6L, 6 dB ± 0.09 dB (X2), locking	0874-9569
874-G10, 10 dB ± 0.15 dB, non-locking	0874-9570
874-G10L, 10 dB ± 0.15 dB, locking	0874-9571
874-G14, 14 dB ± 0.21 dB (X5), non-locking	0874-9560
874-G14L, 14 dB ± 0.21 dB (X5), locking	0874-9561
874-G20, 20 dB ± 0.30 dB (X10), non-locking	0874-9572
874-G20L, 20 dB ± 0.30 dB (X10), locking	0874-9573

* Connector on each end; locking or non-locking, as noted.



874-G, non-locking

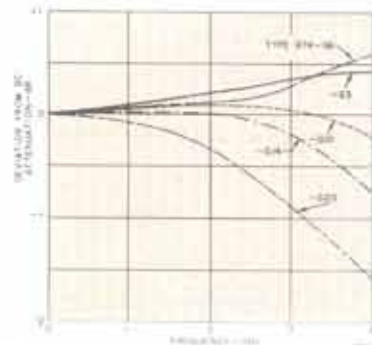

Correction factor

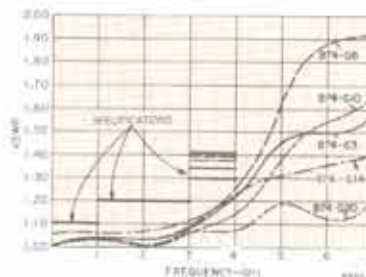

Typical and specified SWR

Adjustable Attenuator

A waveguide-below-cutoff type, useful as a calibrated attenuator or as a sampling device. Calibrated in decibels, on a micrometer-type scale. Absolute attenuation is the sum of insertion loss and scale reading. Phase shift is essentially constant as the attenuation is varied. The main line is a short coaxial section with locking GR874 connectors, one end for source, the other for load. It introduces minimal discontinuity when inserted in a 50-ohm line. The loop output is brought out through 3 feet of 50-ohm cable with a locking GR874 connector. If a source is connected to this output port, signals with relative phases of 0° and 180° are produced at the main line connectors.

Frequency: 100 MHz to 4 GHz.

Relative Attenuation: RANGE: 120 dB, with main line terminated in 50 Ω ; 129 dB, with main line terminated in adjustable stub, set to minimize electric field at the coupling point. MICROMETER SCALE: -9 to 120 dB. ACCURACY: For 50- Ω terminated input, $\pm (0.015 \times \text{difference in scale readings} + 0.2)$ dB, when corrected; correction chart is supplied. For stub-terminated input, $\pm (0.01 \times \text{difference in scale readings} + 0.2)$ dB, direct reading.

Insertion Loss from input connector to end of output cable at 1 GHz, when signal source impedance is 50 Ω : For 50- Ω terminated main line, 30.4 ± 2 dB with scale set at 0 dB; 17 ± 2 dB with scale set at -9 dB (settings below 0 dB not accurate). For stub-terminated unit (that extends range over which calibration is accurate to the -9 dB scale setting), 19 ± 2 dB min. Insertion loss is approx proportional to 1/f, up to 1 GHz. Insertion loss directly through main line is negligible.

SWR: MAIN LINE: < 1.03 at 1 GHz, < 1.12 from 1 to 4 GHz. OUTPUT: < 4 at 1 GHz, < 5 from 1 to 4 GHz.

Electrical: INPUT POWER, max: 300 W at 1 GHz; proportional 1/ \sqrt{f} . OUTPUT, max: 0.5 W.

Mechanical: WEIGHT: 1.3 lb (0.6 kg) net.

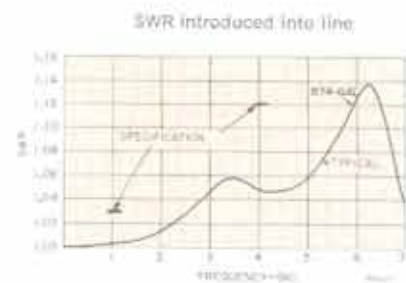

Description	Catalog Number
874-GAL 50- Ω Adjustable Attenuator	0874-9577

Ⓜ Federal stock numbers are listed before the index.



The manual-remote model offers manual control and a cabinet for bench use.

The remote-only model offers small size and reduced cost for systems use.



1452 Programmable Attenuator

**New Since
Catalog U**

- all solid-state — no relays
- 10 kHz to 500 MHz
- 0 to 80 dB in 1-dB steps
- high accuracy
- fast switching, < 500 μ s
- precision metal-film resistors ensure long-term stability

80-dB, no waiting The 1452 provides any attenuation from 0 to 80 dB for any signal from 10 kHz to 500 MHz in less than half a millisecond! Signals up to a half watt are accommodated at most frequencies; insertion loss and SWR are minimal.

Reliable and adaptable There are no life-limited relays in the 1452; all switching is accomplished by solid-state devices. The accuracy is achieved by precision metal-film resistors with long-term stability, and careful design of the attenuator networks preserves their 50-ohm characteristic impedance.

Two models are offered. One allows manual, as well as remote, control of the attenuator. It includes a cabinet for bench use which can also be adapted for installation in a standard rack. The other saves money and space in systems applications by excluding manual control and instrument cabinet.

— See **GR Experimenter** for October-December 1970

SPECIFICATIONS

Frequency: 10 kHz to 500 MHz.

Impedance: 50 Ω .

Attenuation: 0 to 80 dB with 1-dB resolution. Controlled by two in-line-readout panel rotary switches (0 to 79 dB) on manual-remote model or remotely (0 to 80 dB) by 40-20-10-8-4-2-1 BCD signal at standard DTL and TTL levels (negative true, logic "1" = ± 1 V at 0.7 mA, logic "0" = +3.5 to +5 V at 0 mA)



Rear view of manual-remote model.

applied to rear 14-pin type 57 connector on manual-remote and remote-only models. **SWITCHING TIME:** <500 μ s including settling time at max rate of 2000 changes/s for 1-dB steps, 400 for 10-dB steps, 300 for 20-dB steps, and 200 for 40-dB steps.

	10 kHz	1 MHz	10 MHz	100 MHz	300 MHz	500 MHz
Attenuation Accuracy*	$\pm(1\% + 0.4 \text{ dB})$	$\pm(0.5\% + 0.2 \text{ dB})$	$\pm(1\% + 0.4 \text{ dB})$	$\pm(1\% + 0.7 \text{ dB})$		
SWR†	< 1.4/1.1		< 1.6/1.3		< 1.6/1.5	
Insertion Loss	$\leq 2 \text{ dB}$					
Maximum Input	0.02 W, 1 V	0.1 W, 2.2 V	0.5 W, 5 V			

* Accuracy as % of attenuation setting. † Max/typical.

Typical switching transition 0 to 20-dB attenuation at 30 MHz; 1 ms/div horizontal, 10 dB/div vertical.

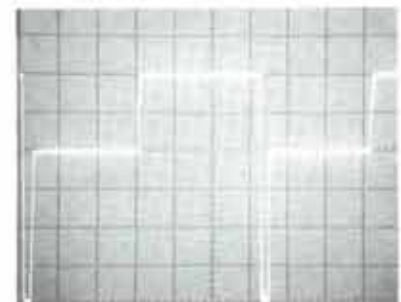

Environment: TEMPERATURE: 0 to +55°C operating, -40 to +75°C non-operating. HUMIDITY: 95% RH and +40°C. VIBRATION: 0.03 in. from 10 to 55 Hz for manual-remote model, 10 to 41 Hz for remote-only model. BENCH HANDLING: 4 in. or 45° (MIL STD-810A-VI). SHOCK: 30 G, 11 ms. DROP: 30 in.

Power: 100 to 125 and 200 to 250 V, 50 to 400 Hz, 21 W max.

Mechanical: Manual-remote and remote-only models. DIMENSIONS (wtxhxd): Manual-remote, 8.5x3.47x13.39 in. (216x88x340 mm); remote-only, 9.13x3.47x10.64 in. (232x88x270 mm). WEIGHT: Manual-remote, 8 lb (3.7 kg) net, 11 lb (5 kg) shipping; remote-only, 5.5 lb (2.5 kg) net, 8.5 lb (3.9 kg) shipping.

Description	Catalog Number
1452 Programmable Attenuator	
Manual-Remote, Bench Model	1452-9700
Manual-Remote, Rack Model	1452-9701
Remote-Only Model	1452-9702
Rack Adaptor Set, for manual-remote model	0480-9722

GR874® 50-Ohm Air Lines

Fixed Air Lines

For use as spacing interconnecting elements of a coaxial system, as time-delay elements, and as absolute impedance references in time-domain reflectometry. Each air line consists of a length of 50- Ω , air-dielectric coaxial line with a GR874 connector at each end.

Frequency: Dc to 7 GHz; to 9 GHz if connectors are locked.
Electrical: IMPEDANCE: 50 Ω INPUT VOLTAGE: Up to 1500 V pk. POWER, average into 50- Ω load: Up to 40 kW, dc to 50 kHz, decreasing as $1/\sqrt{f}$ to 0.1 kW at 10 GHz.

Length:	ELECTRICAL	DELAY TIME
874-L10, -L10L	10.085 \pm 0.06 cm	0.3356 \pm 0.0018 ns
874-L20, -L20L	20.095 \pm 0.06 cm	0.6706 \pm 0.0018 ns
874-L30, -L30L	30.111 \pm 0.06 cm	1.0047 \pm 0.0018 ns

874-L, non-locking

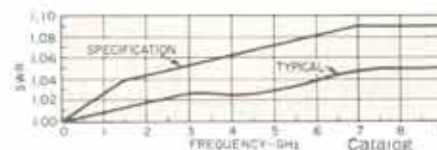

Description

50- Ω Fixed Rigid Air Lines

874-L10, 10 cm, non-locking GR874 connectors	⊕	0874-9604
874-L10L, 10 cm, locking GR874 connectors	⊕	0874-9605
874-L20, 20 cm, non-locking GR874 connectors	⊕	0874-9608
874-L20L, 20 cm, locking GR874 connectors	⊕	0874-9609
874-L30, 30 cm, non-locking GR874 connectors	⊕	0874-9612
874-L30L, 30 cm, locking GR874 connectors	⊕	0874-9613

Adjustable Air Line

An air-dielectric coaxial line that can be telescoped to change its length. For use in matching networks, as a phase shifter, and as a variable line-delay element. Contacts are made by multiple-spring fingers and connectors are locking GR874.

Frequency: Dc to 7 GHz.
Length of Adjustment: 25 cm (half wavelength at 600 MHz).
Electrical: IMPEDANCE: \approx 50 Ω when fully collapsed, \approx 57 Ω when fully extended. INPUT VOLTAGE: Up to 1500 V pk. POWER, average into 50- Ω load: Up to 40 kW, dc to 30 kHz, decreasing as $1/\sqrt{f}$ to 0.1 kW at 5 GHz.
Mechanical: LENGTH: 13 to 23 in. (33 to 58 cm).



Typical SWR curves (solid lines) and 874-LK10L specifications (colored dashes).

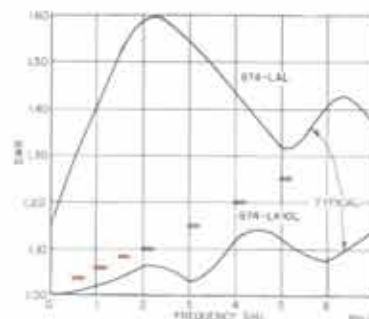

50- Ω Adjustable Air Line

874-LAL, 25 cm, locking GR874 connectors	⊕	0874-9621
--	---	-----------

Constant-Impedance Adjustable Air Lines

Line stretchers with a very low SWR and a uniform characteristic impedance of 50 Ω . Especially useful for eliminating the usual Smith-chart corrections for length of line between unknown and impedance-measuring device. Also useful as impedance-matching transformers and phase-adjustment elements in coaxial systems. Most useful at frequencies above that for which the length of adjustment is a half wavelength.

Frequency: Dc to 7 GHz.

	874-LK10L	874-LK20L
Length of Adjustment	10 cm	22 cm
HALF WAVELENGTH	at 1.5 GHz	at 680 MHz
SWR, also see curve above	< 1.03 at 500 MHz, < 1.06 at 1 GHz, < 1.08 at 1.5 GHz, < 1.10 at 2 GHz	
	< 1.15 at 3 GHz, < 1.2 at 4 GHz, < 1.25 at 5 GHz	

Electrical: IMPEDANCE: 50 Ω . INPUT VOLTAGE: Up to 1500 V pk. POWER, average into 50- Ω load: Up to 40 kW, dc to 30 kHz, decreasing as $1/\sqrt{f}$ to 0.1 kW at 5 GHz.
Mechanical: LENGTH (min): -LK10L, 14 in. (35 cm); -LK20L, 23 in. (58 cm).



50- Ω Constant-Impedance Adjustable Air Lines

874-LK10L, 10 cm, locking GR874 connectors	⊕	0874-9627
874-LK20L, 20 cm, locking GR874 connectors	⊕	0874-9631

Trombone Constant-Impedance Adjustable Air Line

Used to vary the length of a 50- Ω transmission line between two fixed terminals without moving the terminals or using flexible cables. Consists of two 874-LK20L Adjustable Lines joined at one end by a U-shaped section to form a rigid assembly. Can be plugged into two adjacent GR874 coaxial connectors or inserted in a line by means of two ellis (not included) and installed vertically to save bench space. Low SWR. An excellent phase shifter and variable delay line.

Frequency: Dc to 2 GHz (874-LK10L recommended above 2 GHz).

Length of Adjustment, electrical: 44 cm (half wavelength at 340 MHz).

SWR: < 1.10 to 1 GHz, < 1.25 to 2 GHz.

Electrical: IMPEDANCE: 50 Ω .

Mechanical: LENGTH: 24 to 33 in. (61 to 83 cm). SPACING between centers: 1.1875 in. (30 mm). WEIGHT: 2.5 lb (1.2 kg) net.



50- Ω Trombone Constant-Impedance Adjustable Air Line

874-LTL, 44 cm, locking GR874 connectors	⊕	0874-9645
--	---	-----------

⊕ Federal stock numbers are listed before the inhex.

GR874[®] 50-Ohm Coupling Elements

Tee

For connecting stubs and other elements in shunt with a coaxial line.

Electrical: IMPEDANCE: 50 Ω , nominal. INPUT VOLTAGE: Up to 1500 V pk. POWER, average into 50- Ω load: Up to 40 kW, dc to 50 kHz, decreasing as $1/\sqrt{f}$ to 0.1 kW at 10 GHz.

Mechanical: DIMENSIONS: 3.38 in. (86 mm) long x 2.25 in. (57 mm) wide. WEIGHT: 0.4 lb (0.2 kg) net.



Description

Catalog Number

50- Ω Tees
874-T, non-locking GR874 connectors
874-TL, locking GR874 connectors

0874-9910
0874-9911

Power Divider

A coaxial tee with a 16.67- Ω resistor in each leg, connected so the tee is matched at any port when the other two ports are terminated in 50- Ω loads. The match holds throughout the wide frequency range. There is 0° phase difference between the outputs. The use of stable deposited-carbon-film resistors and the linear SWR-frequency relationship make these power dividers particularly valuable for pulse work and in network-analyzer applications.

Frequency: Dc to 7 GHz; to 9 GHz if connectors are locked.

Power Division: Equal within 0.3 dB when symmetrically fed.
Electrical: IMPEDANCE: 50 Ω , nominal. INSERTION LOSS: 6 dB (+2, -0.5 dB), input to each output. INPUT POWER: 2 W max continuous.

Mechanical: DIMENSIONS: 4 in. (102 mm) long x 2.38 in. (50 mm) wide.



50- Ω Power Divider
874-TPD, non-locking GR874 connectors
874-TPDL, locking GR874 connectors

0874-9912
0874-9913

90° EII

Convenient right-angle line section.

SWR: <1.06 at 2 GHz, <1.15 at 4 GHz.
Electrical: IMPEDANCE: 50 Ω , nominal. ELECTRICAL LENGTH: \approx 7 cm. INPUT VOLTAGE: Up to 1500 V pk. POWER, average into 50- Ω load: Up to 40 kW, dc to 50 kHz, decreasing as $1/\sqrt{f}$ to 0.1 kW at 10 GHz.

Mechanical: DIMENSIONS: 2.25 in. (57 mm) long x 2.25 in. (57 mm) wide.



50- Ω 90° EII
874-EL, non-locking GR874 connectors
874-EL-L, locking GR874 connectors

0874-9526
0874-9527

U-Line Section

A coaxial line section in the shape of a U that is useful in many coaxial setups.

Frequency: Dc to 7 GHz.
Electrical: IMPEDANCE: 50 Ω , nominal.
Mechanical: DIMENSIONS (wxhxd): 2.25x2x0.88 in. (57x51x22 mm). WEIGHT: 0.5 lb (0.3 kg) net.

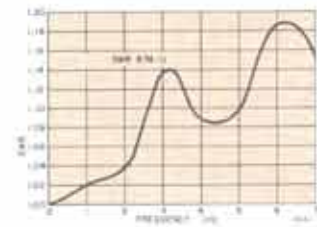

Description	Catalog Number
874-U, U-Line Section, non-locking GR874 connectors	0874-9528

Rotary Joint

Used when one part of a coaxial system must be rotated with respect to another part. Not for motor-driven applications.

Frequency: Dc to 4 GHz.
SWR: <1.06 at 1 GHz, <1.3 at 4 GHz.
Electrical: IMPEDANCE: 50 Ω , nominal.
Mechanical: LENGTH: 2.5 in. (64 mm).



874-JR Rotary Joint, 50 Ω , non-locking GR874 connectors 0874-9590

Mixer

A broadband mixer of improved design for use in general applications and, with the 1236 I-F Amplifier, as a heterodyne detector. It offers wider frequency range, lower SWR, lower-leakage connectors; it requires less local-oscillator power.

Frequency: 10 MHz to 9 GHz. MAX I-F: 60 MHz.
Sensitivity: <6 μ V, typical, input behind 50 Ω will increase output of I-F amplifier (30-MHz i-f, 0.5-MHz bandwidth, 2-dB noise figure) by 3 dB, for mixer current of 0.5 mA.
Input: < 6 mW typically required from local oscillator for 0.2-mA rectified current (signal and l-o source impedances, each 50 Ω).

Electrical: IMPEDANCE: 50 Ω , input; 400 Ω avg//7 pF, output. DIODE: 1N23C.
Mechanical: DIMENSIONS: 4.63 in. (117 mm) long x 2.5 in. (64 mm) wide. WEIGHT: 0.5 lb (0.3 kg) net.

Typical SWR (mixer current = 0.5 mA);

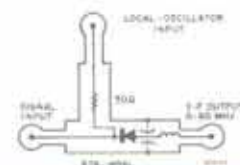
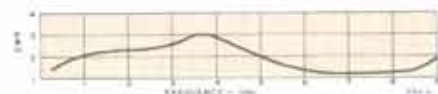

874-MRAL Mixer, locking GR874 connectors 0874-9947

Ⓜ Federal stock numbers are listed before the Index.

Mixer Rectifiers

A broadband rf mixer for use as a heterodyne detector with an i-f amplifier.

Frequency: 40 MHz to 5 GHz, less sensitive at lower and higher frequencies. MAX I-F: 30 MHz.

Sensitivity: $< 5 \mu\text{V}$ typical (equivalent to $\approx 10 \mu\text{V}$ behind 50 Ω to increase output of i-f amplifier by 3 dB).

Input: 2 V max required from local oscillator.

Electrical: IMPEDANCE: 50- Ω input, \approx 400- Ω output. DIODE: 1N21B.

Mechanical: DIMENSIONS: 3.75 in. (95 mm) long x 3.5 in. (89 mm) wide.



locking

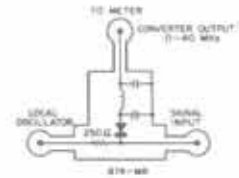

Description

Catalog Number

50- Ω Mixer Rectifiers

874-MR, non-locking GR874 connectors

874-MRL, locking GR874 connectors

0874-9944

0874-9945

Voltmeter Rectifiers

Used to monitor the voltage in a coaxial system. Similar to 874-VQ but includes a 50- Ω resistor in series with the output-port center conductor. In combination with a signal source and a properly calibrated indicator, it can simulate a 50- Ω generator with known open-circuit voltage and thus be used in an oscillator amplitude-regulating system.

Frequency: 15 MHz to 2.5 GHz when used as a calibrated voltmeter.

Electrical: IMPEDANCE: 50 Ω nominal. INPUT VOLTAGE: 2 V max. BYPASS CAPACITANCE: \approx 300 pF. DIODE: 1N23B.

Mechanical: DIMENSIONS: 3.75 in. (95 mm) long x 2.5 in. (64 mm) wide. WEIGHT: 0.4 lb (0.2 kg) net.



locking

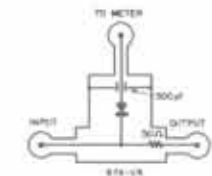

50- Ω Voltmeter Rectifiers

874-VR, non-locking GR874 connectors

874-VRL, locking GR874 connectors

0874-9942

0874-9943

Voltmeter Detectors

For use as a general-purpose rf-level detector with a dc indicator or as a modulated-signal detector with a sensitive amplifier. It can be inserted into a 50- Ω line without introducing appreciable discontinuity or, with a GR874 50- Ω termination, it can be used as a matched detector to terminate a line.

Frequency: 500 kHz to 2 GHz when used as a matched detector.

SWR: < 1.1 at 1 GHz, < 1.2 at 2 GHz.

Electrical: IMPEDANCE: 50 Ω , nominal. INPUT VOLTAGE: 2 V max. BYPASS CAPACITANCE: \approx 300 pF. DIODE: 1N23B.

Mechanical: DIMENSIONS: 3.75 in. (95 mm) long x 2.5 in. (64 mm) wide. WEIGHT: 0.4 lb (0.2 kg) net.



locking

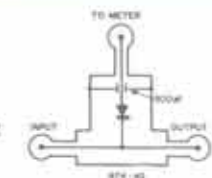

Typical SWR and correction factor for 874-VQ.

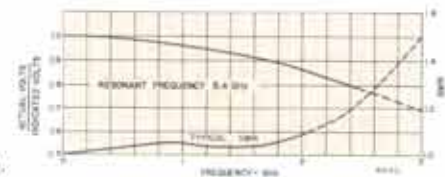

50- Ω Voltmeter Detectors

874-VQ, non-locking GR874 connectors

874-VQL, locking GR874 connectors

0874-9940

0874-9941

Low-Pass Filters

Recommended for use in impedance- or voltage-measuring systems to reduce harmonics, and especially in systems that contain nonlinear elements or sections that might resonate at a harmonic. Also useful in slotted-line measurements. Uses Chebyshev-type filters that produce a very steep cutoff characteristic at the expense of passband flatness. Spurious responses in the stopband are very small.

Electrical: IMPEDANCE: 50 Ω , nominal. INPUT VOLTAGE: Up to 200 V pk. POWER, average into 50- Ω load; Up to 0.8 kW, dc to 20 MHz, decreasing as $1/\sqrt{f}$ to 0.1 kW at 1 GHz.

Mechanical: LENGTH: -F185L, 17.63 in. (448 mm); -F500L, 10.19 in. (259 mm); -F1000L, 7.13 in. (181 mm); -F2000L, 4.38 in. (111 mm).



874-F2000L

Typical insertion loss and SWR

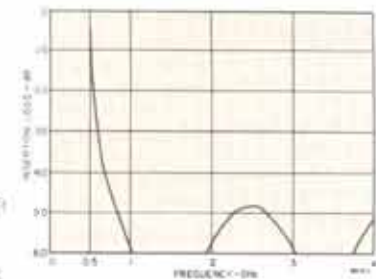
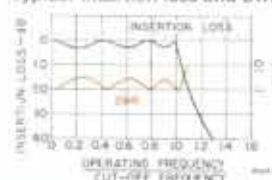

Typical stop-band response of 874-F500L.

50- Ω Low-Pass Filters

874-F185L, 185 MHz, locking GR874 connectors

874-F500L, 500 MHz, locking GR874 connectors

874-F1000L, 1 GHz, locking GR874 connectors

874-F2000L, 2 GHz, locking GR874 connectors

0874-9533

0874-9537

0874-9541

0874-9545

⊗ Federal stock numbers are listed before the Index.

GR874® 50-Ohm Coupling Elements (Cont'd)

Coupling Capacitor

A short length of coaxial line with a disk capacitor in series with the inner conductor. High frequencies are transmitted with small reflections, but dc and low audio frequencies are blocked.

Frequency: To 4 GHz.

Capacitance: 4700 pF, $-20 + 50\%$, series.

SWR: <1.06 at 1 GHz, <1.15 at 2 GHz, <1.3 from 2 to 4 GHz.

Electrical: IMPEDANCE: 50 Ω , nominal. INPUT VOLTAGE: Up to 500 V pk. POWER, average into 50- Ω load: Up to 5 kW up to 500 kHz, decreasing as $1/\sqrt{f}$ to 0.1 kW at 1 GHz.

Mechanical: LENGTH: 3 in. (76 mm).



Description	Catalog Number
50- Ω Coupling Capacitors 874-K, non-locking GR874 connectors 874-KL, locking GR874 connectors	0874-9596 0874-9597

Series Inductor

Used as a general-purpose tuning element in resonant-line circuits, matching transformers, and baluns at low frequencies.

Frequency: To 300 MHz.

Inductance: 0.226 μ H $\pm 5\%$ at 1 kHz, series.

Electrical: IMPEDANCE: 50 Ω , nominal.

Mechanical: WEIGHT: 0.25 lb (0.1 kg) net.



874-XL Series Inductor, non-locking GR874 connectors	0874-9998
--	-----------

Insertion Unit

Small components, pads, vhf transformers, filters, or other networks mounted within the 2-inch long, 9/16-inch diameter space can be conveniently inserted into a 50- Ω coaxial system with minimum leakage and discontinuity.

Electrical: IMPEDANCE: 50 Ω , nominal.

Mechanical: LENGTH: 4.38 in. (111 mm).

Description	Catalog Number
874-X Insertion Unit, non-locking GR874 connectors	0874-9990



Component Mount

A shielded enclosure for convenient mounting of small components to be measured. Use of mount minimizes stray-capacitance variation in impedance measurements of circuit elements. Includes two accessories, an 874-WN3 Short-Circuit Termination and an 874-WO3 Open-Circuit Termination. For use with 1602-B UHF Admittance Meter, an 874-LK20L Constant-Impedance Adjustable Line is also recommended.

Frequency: Dc to 5 GHz.

Electrical: IMPEDANCE: 50 Ω , nominal.

Mechanical: DIAMETER: 3 in. (76 mm). WEIGHT: 0.7 lb (0.4 kg) net.

874-ML Component Mount, locking GR874 connector	0874-9663
---	-----------



Coupling Probe

Electrostatic probe consisting of a binding post mounted on a GR874 connector. (Note: A pair of posts is also available, the 874-Q2 Adaptor.)

Electrical: IMPEDANCE: 50 Ω , nominal.

Mechanical: LENGTH: 2.08 in. (53 mm).



874-MB Coupling Probe, non-locking GR874 connector	0874-9666
--	-----------

Bias Insertion Unit

Used with slotted lines, the 1602-B Admittance Meter, and 1609 UHF Admittance Bridge for immittance and similar measurements when bias is to be applied to diodes, transistors, and other solid-state devices. It comprises a blocking capacitor in series with the line, an isolating choke, and a low-pass filter. In slotted-line measurements, the unit is inserted at the source end of the line and therefore introduces no reflections at the measurement terminals.

Frequency: Dc to 5 MHz, in bias circuit.

Electrical: IMPEDANCE: 50 Ω , nominal. BIAS, max: 400 V or 2.5 A. INSERTION LOSS: <1.7 dB typical from 300 MHz to 3 GHz, <0.8 dB typical from 3 to 5 GHz.

Mechanical: DIMENSIONS: 4.38 in. (111 mm) long x 3.88 in. (98 mm) wide. WEIGHT: 0.5 lb (0.3 kg) net.

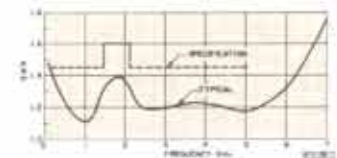
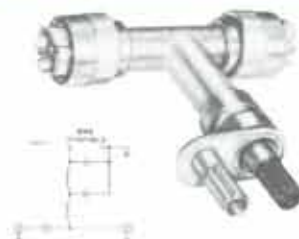

874-FBL Bias Insertion Unit, with locking GR874 connectors	0874-9759
--	-----------

⊕ Federal stock numbers are listed before the Index.

GR874® Cable and Patch Cords

50-Ohm Coaxial Cable

Low-loss 874-A2 This flexible, double-shielded, low-loss coaxial cable consists of No. 14 stranded inner conductor centered in solid polyethylene dielectric (OD: 0.244 in.) sheathed by 2 tinned-copper braids and covered with a gray, noncontaminating polyvinyl-chloride jacket.

General-purpose 874-A3 This cable is more flexible than the 874-A2 but with somewhat higher losses; it is the same as RG-58A/U but with double braided shielding. The inner conductor is 19 strands of 0.0071-in. tinned soft-copper wire, centered in solid polyethylene dielectric (OD: 0.115 in.) sheathed by 2 tinned-copper braids. The jacket is black, noncontaminating polyvinyl chloride. This cable is recommended for most general-purpose applications.

	Capacitance, nominal	Attenuation/100 ft			Use Connectors GR874-
		100 MHz	1 GHz	3 GHz	
874-A2	30.8 pF/ft	2.6 dB	10.5 dB		-CA, -CLA, -PBA, -PLA, -PRLA
874-A3	29 pF/ft	5.3 dB	22 dB	15 dB	-C58A, -CL58A, -PB58A, -PL58A, -PRL58

Electrical: IMPEDANCE: 50 Ω \pm 5%. PROPAGATION VELOCITY FACTOR: 66%.

Mechanical: OUTER DIAMETER: -A2, 0.375 in. (9.5 mm); -A3, 0.206 in. (5.3 mm). WEIGHT: -A2, 3 lb per 25 ft (0.18 kg/m) net; -A3, 1 lb per 25 ft (0.06 kg/m), net.



Description

50- Ω Coaxial Cable

874-A2, low-loss (100-foot length)
874-A3, general-purpose, (100-foot length)

Catalog Number

0874-9862
0874-9863

50-, 72-, and 75-Ohm Coaxial Patch Cords



874-R20A



874-R22LA



874-R33



874-R34

874-R20 and -R22 These cords (50 Ω or 75 Ω) feature low SWR to 9 GHz and convenient GR874 connectors at each end.

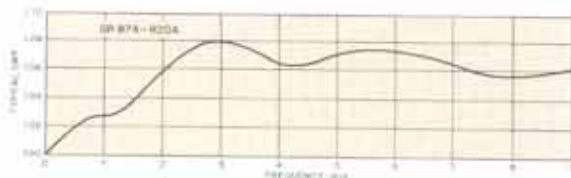

874-R33 This cord (72 Ω) terminates in a pair of banana plugs, one connected to the center conductor and the other to the braid through a 5-in. pigtail. These plugs mate directly with GR 274 and 938 Jacks and 938 Binding Posts. The other end has a GR874 connector.

874-R34 This cord (50 Ω) terminates in a 274-NK Shielded Double Plug. The other end has a GR874 connector.

Electrical Rating: INPUT VOLTAGE: -R20, up to 1000 V pk; -R22, up to 500 V pk. POWER, average into 50- Ω load: -R20, up to 20 kW, dc to 100 kHz, decreasing as $1/\sqrt{f}$ to 0.1 kW at 5 GHz; -R22, up to 5 kW, dc to 500 MHz, decreasing as $1/\sqrt{f}$ to 0.1 kW at 1 GHz.

50- Ω Coaxial Patch Cords, 3 ft long

Low-loss 874-A2 cable, GR874 connectors

874-R20A, non-locking

874-R20LA, locking

General-purpose 874-A3 cable, GR874 connectors

874-R22A, non-locking

874-R22LA, locking

General-purpose RG-58C/U cable

874-R34, with shielded double banana plug

72- Ω Coaxial Patch Cord, 3 ft long

Low-capacitance cable

874-R33, with pair of banana plugs

75- Ω Coaxial Patch Cord, 3 ft long

Low-loss cable, GR874 75- Ω connectors

874-R20L (75 Ω)

General-purpose cable, GR874 75 Ω connectors

874-R22L (75 Ω)

0874-9680
0874-9681

0874-9682
0874-9683

0874-9692

0874-9690

0874-9757

0874-9758

Ⓢ Federal stock numbers are listed before the Index.

GR874® 75-Ohm Components

New

New versatility A new series of GR874 general-purpose coaxial components extends the versatility of the line to the field of 75-ohm transmission-line measurements. The series includes matching pads and adaptors to permit direct conversion of existing 50-ohm systems to the 75-ohm capability.

The GR874 75-ohm components use a connector similar to their 50-ohm counterparts except a new inner conductor and insulating bead are used to achieve the 75-ohm characteristic impedance. Although the GR874 50-

ohm and 75-ohm connectors will mate with one another, the combination is not recommended because the inner conductors do not join snugly. A black outer ring is used on the 75- Ω connectors; bright metal, on the 50- Ω ones, ensures distinction.

Frequency response for the new series is specified from dc to 2 GHz although the units are often satisfactory at higher frequencies. Locking connectors are standard in the series; nonlocking 75- Ω connectors are available in OEM quantities.

Basic Connector

For use on rigid 14-mm, air-dielectric, 75- Ω coaxial lines or with capacitance, inductance, and resistance standards.

Frequency: Dc to 2 GHz.

Electrical: IMPEDANCE: 75 Ω , nominal. INPUT: 1.5 kV max, 4 kW max to 1 MHz, 4 kW/ $\sqrt{f_{MHz}}$ max above 1 MHz. LEAKAGE: > 120 dB below signal.

Mechanical: DIMENSIONS: 1.13 in. (29 mm) long x 1.02 in. (26 mm) dia. WEIGHT: 0.2 lb (0.1 kg) net, 1 lb (0.5 kg) shipping.

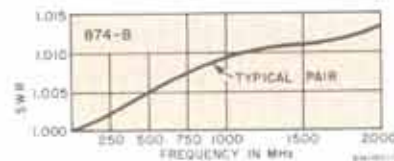

Description	Catalog Number
874-B (75- Ω) Basic Connector	0874-9730

Cable Connectors

For use with flexible cable such as RG-11, RG-59, and RG-187.

Frequency: Dc to 2 GHz.

Electrical: IMPEDANCE: 75 Ω , nominal. INPUT: 1 kV for 0874-9742; 500 V for 0874-9743; 300 V for 0874-9744. LEAKAGE: > 120 dB below signal at GR874 (75 Ω) junction only.

Mechanical: DIMENSIONS: 3.27 in. (83 mm) long x 1.02 in. (26 mm) dia. WEIGHT: 0.2 lb (0.1 kg) net, 1 lb (0.5 kg) shipping.



Description	Catalog Number
75-Ω Cable Connector	
874-C11 (75- Ω), for RG-11 A/U, -12 A/U, -216/U cable	0874-9742
874-C59 (75- Ω), for RG-59 B/U, -140/U cable	0874-9743
874-C187 (75- Ω), for RG-187 A/U, -179 B/U cable	0874-9744

Panel Connectors

For use on equipment panels.

Frequency: Dc to 2 GHz.

Electrical: IMPEDANCE: 75 Ω , nominal. INPUT: 1 kV for 0874-9745, 500 V for 0874-9746, 300 V for 0874-9747. LEAKAGE: > 120 dB below signal at GR874 (75 Ω) junction only.

Mechanical: DIMENSIONS: 0874-9745 2.08 in. (53 mm) long; 0874-9746 2.23 in. (57 mm) long; 0874-9747 2.53 in. (64 mm) long; ALL 1.06 in. (27 mm) dia. WEIGHT: 0.2 lb (0.1 kg) net, 1 lb (0.5 kg) shipping.



Description	Catalog Number
75-Ω Panel Connector	
874-P11 (75- Ω), for RG-11 A/U, -12A/U, -216/U cable	0874-9745
874-P59 (75- Ω), for RG-59 B/U, -140/U cable	0874-9746
874-P187 (75- Ω), for RG-187 A/U, -179 B/U cable	0874-9747

Adaptors to BNC

Two adaptors are available; one includes a 75- Ω BNC jack and the other includes a 75- Ω BNC plug. Each uses a locking GR874 (75- Ω) connector on the other end.

Frequency: Dc to 2 GHz.

Electrical: IMPEDANCE: 75 Ω , nominal. INPUT: 500 V max; 3 kW max to 1 MHz, 3 kW/ $\sqrt{f_{MHz}}$ max above 1 MHz.

Mechanical: DIMENSIONS: 0874-9750 1.5 in. (39 mm) long; 0874-9751 1.81 in. (46 mm) long; ALL 1.02 in. (26 mm) dia. WEIGHT: 0.2 lb (0.1 kg) net, 1 lb (0.5 kg) shipping.

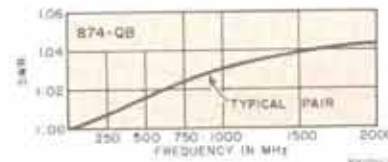

Description	Catalog Number
75-Ω Adaptors to BNC	
874-QBJ (75- Ω), with BNC jack	0874-9750
874-QBP (75- Ω), with BNC plug	0874-9751

Adaptors to Type F

Two adaptors are available; one includes a type F jack and the other includes a type F plug. Each uses a locking GR874 (75- Ω) connector on the other end. Type F jacks are designed for use with 0.023-in. dia. (0.58 mm) wire.

Frequency: Dc to 2 GHz.

Electrical: IMPEDANCE: 75 Ω , nominal.

Mechanical: DIMENSIONS: 0874-9748 2.1 in. (52 mm) long; 0874-9749 1.87 in. (48 mm) long; ALL 1.02 in. (26 mm) dia. WEIGHT: 0.2 lb (0.1 kg) net, 1 lb (0.5 kg) shipping.

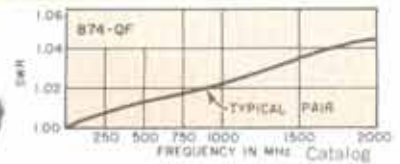

Description

75- Ω Adaptors to F
874-QFJ (75- Ω), with type F jack
874-QFP (75- Ω), with type F plug

0874-9748
0874-9749

Adaptors to Type N

Two adaptors are available; one includes a (75- Ω) type N jack and the other includes a 75- Ω type N plug. Each uses a locking GR874 (75- Ω) connector on the other end.

Frequency: Dc to 2 GHz.

Electrical: IMPEDANCE: 75 Ω , nominal. INPUT: 1 kV max; 4 kW to 1 MHz, 4 kW/ $\sqrt{f_{MHz}}$ max above 1 MHz.

Mechanical: DIMENSIONS: 0874-9754 1.62 in. (41 mm) long; 0874-9755 1.95 in. (50 mm) long; ALL 1.02 in. (26 mm) dia. WEIGHT: 0.2 lb (0.1 kg) net, 1 lb (0.5 kg) shipping.

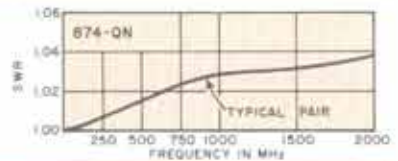

75- Ω Adaptors to N

874-QNJ (75- Ω), with type N jack
874-QNP (75- Ω), with type N plug

0874-9754
0874-9755

Adaptors to Large WE

Two adaptors are available; one includes a large Western Electric jack and the other includes a large Western Electric plug. Each uses a locking GR874 (75- Ω) connector on the other end.

Frequency: Dc to 1 GHz.

Electrical: IMPEDANCE: 75 Ω , nominal.

Mechanical: DIMENSIONS: 0874-9740 3.52 in. (89 mm) long; 0874-9741 3.02 in. (77 mm) long; ALL 1.02 in. (26 mm) dia. WEIGHT: 0.2 lb (0.1 kg) net, 1 lb (0.5 kg) shipping.

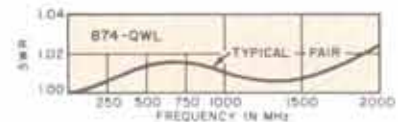

Description

Catalog Number

75- Ω Adaptors to Western Electric, large
874-QWJL (75- Ω), with large WE jack
874-QWPL (75- Ω), with large WE plug

0874-9740
0874-9741

Adaptors to Small WE

Two adaptors are available; one includes a small Western Electric jack and the other includes a small Western Electric plug. Each uses a locking GR874 (75- Ω) connector on the other end.

Frequency: Dc to 1 GHz.

Electrical: IMPEDANCE: 75 Ω , nominal.

Mechanical: DIMENSIONS: 0874-9738 3 in. (76 mm) long; 0874-9739 2.75 in. (70 mm) long; ALL 1.02 in. (26 mm) dia. WEIGHT: 0.2 lb (0.1 kg) net, 1 lb (0.5 kg) shipping.

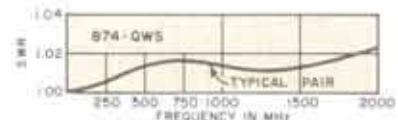

75- Ω Adaptors to Western Electric, small
874-QWJS (75- Ω), with small WE jack
874-QWPS (75- Ω), with small WE plug

0874-9738
0874-9739

Adaptor to GR900 (75 Ω)

Includes a GR900 (75- Ω) connector on one end and a locking GR874 (75- Ω) connector on the other end.

Frequency: Dc to 2 GHz.

Electrical: IMPEDANCE: 75 Ω \pm 0.4%. INPUT: 1.5 kV max; 4 kW max to 1 MHz, 4 kW/ $\sqrt{f_{MHz}}$ max above 1 MHz. LEAKAGE: > 120 dB below signal.

Mechanical: DIMENSIONS: 2.88 in. (73 mm) long x 1.06 in. (27 mm) dia. WEIGHT: 0.2 lb (0.1 kg) net, 1 lb (0.5 kg) shipping.

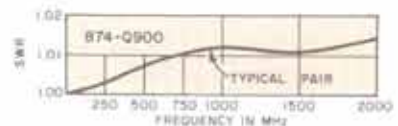

874-Q900 Adaptor, GR874 (75- Ω) to GR900 (75- Ω)

0874-9733

75- to 50-Ohm Matching Pad

A two-port minimum-loss network to match 50-ohm GR874-equipped devices to similarly equipped 75-ohm devices.

Frequency: Dc to 2 GHz.

SWR: 1.05 + 0.12 f_{MHz} for 50- Ω side; 1.05 + 0.08 f_{MHz} for 75- Ω side; also see curve.

Electrical: IMPEDANCE: 50 Ω and 75 Ω . INPUT: 0.5 W max continuous. INSERTION LOSS: 5.72 dB nominal. LEAKAGE: > 120 dB below signal.

Mechanical: DIMENSIONS: 3.5 in. (90 mm) long x 1.02 in. (26 mm) dia. WEIGHT: 0.2 lb (0.1 kg) net, 1 lb (0.5 kg) shipping.

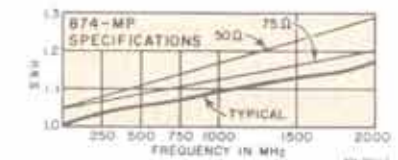

874-MP Matching Pad, 75- Ω to 50- Ω

0874-9736

GR874® 75-Ohm Components (Cont'd)

Short-Circuit Termination

A fixed short circuit mounted in a locking GR874 (75- Ω) connector for establishing reference conditions in coaxial lines.

Frequency: Dc to 2 GHz.

Plane Position: Short-circuit is effectively 0 to 0.10 cm toward load from face of bead.

Mechanical: DIMENSIONS: 1.19 in. (30 mm) long x 1.02 in. (26 mm) dia. WEIGHT: 0.2 lb (0.1 kg) net, 1 lb (0.5 kg) shipping.

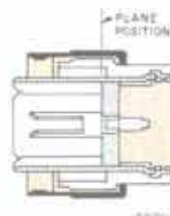

Description

Catalog Number

874-WN (75- Ω) Short-Circuit Termination

0874-9732

Open-Circuit Termination

A fixed open circuit mounted in a locking GR874 (75- Ω) connector for establishing reference conditions in coaxial lines; also useful as a shielding cap for open-circuited lines.

Frequency: Dc to 2 GHz.

Plane Position: Open-circuit plane is 0 to 0.10 cm toward load from nominal position of face of bead, to match the short-circuit plane in 874-WN Short-Circuit Termination above.

Mechanical: DIMENSIONS: 1.89 in. (30 mm) long x 1.02 in. (26 mm) dia. WEIGHT: 0.2 lb (0.1 kg) net, 1 lb (0.5 kg) shipping.



Description

Catalog Number

874-WO (75- Ω) Open-Circuit Termination

0874-9752

75-Ohm Termination

A fixed 75- Ω resistor mounted in a locking GR874 (75- Ω) connector for establishing reference conditions in coaxial lines, for impedance matching, and for use as a termination.

Frequency: Dc to 2 GHz.

Dc Resistance: 75 Ω \pm 0.5%. TEMPERATURE COEFFICIENT: < 150 ppm/°C.

SWR: < 1.005 + 0.013 f_{GHz} to 2 GHz, also see curve.

Electrical: IMPEDANCE: 75 Ω , nominal. INPUT: 1 W with negligible change, 5 W max.

Mechanical: DIMENSIONS: 1.95 in. (50 mm) long x 1.02 in. (26 mm) dia. WEIGHT: 0.2 lb (0.1 kg) net, 1 lb (0.5 kg) shipping.

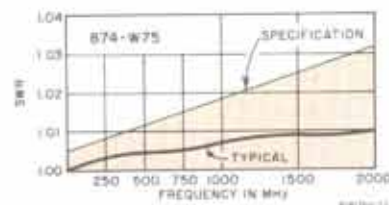

874-W75 (75- Ω) 75- Ω Termination

0874-9737

Fixed Attenuators

Single-section, T-type, resistance pads for attenuation, isolation, or matching in 75-ohm coaxial systems.

Frequency: Dc to 2 GHz.

Attenuation: 0874-9731 is 6 \pm 0.5 dB; 0874-9734 is 10 \pm 0.5 dB. TEMPERATURE COEFFICIENT: < 0.0005 dB/°C/dB.

SWR: < 1.05 + 0.05 f_{GHz} , also see curve.

Electrical: IMPEDANCE: 75 Ω , nominal. DC RESISTANCE: 75 Ω \pm 1% when terminated in 75 Ω . DC ATTENUATION: 0874-9731 is 6 \pm 0.1 dB; 0874-9734 is 10 \pm 0.1 dB. INPUT: 0.5 W max continuous cw; 500 W max peak; 0.5 W max average.

Mechanical: DIMENSIONS: 3.5 in. (89 mm) long x 1.02 in. (26 mm) dia. WEIGHT: 0.2 lb (0.1 kg) net, 1 lb (0.5 kg) shipping.

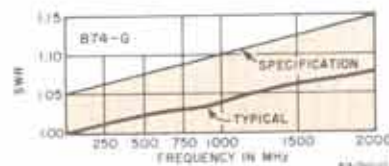

75- Ω Fixed Attenuators

874-G6 (75- Ω), 6-dB attenuation
874-G10 (75- Ω), 10-dB attenuation

0874-9731

0874-9734

Air Line

For use as a spacing stub or other element of a coaxial system or as a time-delay element or impedance standard in a time-domain reflectometer.

Frequency: Dc to 2 GHz.

Length: ELECTRICAL: 30.111 \pm 0.06 cm. TIME DELAY: 1.0036 \pm 0.0018 ns.

SWR: < 1.01 + 1.015 f_{GHz} to 2 GHz, also see curve.

Electrical: IMPEDANCE: 75 Ω \pm 0.4%. INPUT: 1.5 kV max peak; 4 kW max to 1 MHz, 4kW/ $\sqrt{f_{MHz}}$ max above 1 MHz.

Mechanical: DIMENSIONS: 12 in. (305 mm) long x 1.06 in. (27 mm) dia. WEIGHT: 0.4 lb (0.2 kg) net, 2 lb (1 kg) shipping.

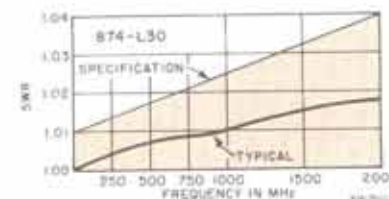

874-L30 (75- Ω) Rigid Air line

0874-9735

GR874® Miscellany

50-Ohm Transistor and Component Mounts

These mounts permit three-terminal measurements of a variety of devices with instruments such as the 1710 RF Network Analyser. Using the recommended short- and open-circuit terminations, you can precisely establish a phase reference plane at the transistor socket or other appropriate surface. By this means, the effects of coaxial line lengths and of the mount itself between unknown and instrument are eliminated.

In each transistor mount, the leads are inserted into hollow contact tubes that are the center conductors of small coaxial lines. Thus, all but about 1/32 inch of the leads at the header are completely shielded; small bends, various lengths, or other irregularities of the leads have no effect and the discontinuity at the transistor-to-mount connection is minimized. Additional advantages include complete accessibility to the socket, provisions for bolting a heat sink to the mount, and a fourth lead in the mount socket that is dc ground.

Frequency: Dc to 5 GHz.

Electrical: IMPEDANCE: 50 Ω , nominal. LEADS: 4. Each mount includes 2 damper resistors (10 and 50 Ω) to control oscillators in the measurement of wide-band, high-gain transistors.

Mechanical: WEIGHT: Mount, 0.8 lb (0.4 kg) net, 2 lb (1 kg) shipping; termination kit, 1 lb (0.5 kg) net, 2.5 lb (1.2 kg) shipping.



Description	Grounded Connection	Pin Circle	Catalog Number
50-Ω Transistor Mounts , require 1607-P40 Termination Kit			
For TO5, 9, 11, 12, 16, 26, 31, 33, 37, 38, 39, 43; MD-14; MM-4, 8; MT-13, 20, 28, 37; RO-2, 3, 4, 5, 10, 24, 30, 33, 34, 46, 49, 50, 61, 62, 79, etc. transistor, diode, and tube packages:			
1607-P41	base	0.2 in. dia	1607-9641
1607-P42	emitter or collector	0.2 in. dia	1607-9642
For TO-18, 28, 52; MT-30, 35; RO-44, 48, 51, 64, 65, 66, 70, 73, 78; U-3; X-8, etc. transistor, diode, and tube packages:			
1607-P43	base	0.1 in. dia	1607-9643
1607-P44	emitter or collector	0.1 in. dia	1607-9644
50-Ω Termination Kit , includes 874-U10 U-Line Section, 874-WN10 Short-Circuit, and 874-WO10 Open-Circuit			
			1607-9640

Stand

A solid, stable support for components of coaxial systems. Consists of a heavy cast-iron base with rubber feet, 22-inch and 8-inch stainless-steel rods, and three universal clamps. The vertical rod can be used to hold long tuning stubs. The horizontal rod can be moved longitudinally or can be clamped to two bases to support a long horizontal run of coaxial parts. Clamps fit a range of diameters. Base can be bolted to bench top.

Mechanical: DIMENSIONS: Base, 3.5x4.44 in. (89x113 mm); rods, 8 and 22 in. (203 and 559 mm). WEIGHT: 5.5 lb (2.5 kg) net.

Description	Catalog Number
874-Z Stand	0874-9996
874-ZC Extra Clamp	0874-9997



Tools

These tools ensure quick assembly, neat, uniform appearance, and best electrical and mechanical performance of GR874 connectors (50 and 75 Ω).

The **874-TOK Tool Kit** consists of an inner-conductor wrench to install the insulating bead and hold the inner conductor, an outer-conductor wrench to install the outer conductor, and a third wrench to tighten the coupling nut. The other tools are useful for installation of retaining rings.

The **874-T058 or -T08 Crimping Tool** assures a neat, fast crimp of the ferrule that clamps the shield braid and outer jacket of the cable to a cable connector.

Crimping Dimensions, across flats of hexagonal crimp: For -T08, 0.389 and 0.411 in. (9.88, 10.45 mm); for -T058, 0.215, 0.250, and 0.375 in. (5.46, 6.35, 9.53 mm).

874-TOK Tool Kit, for all GR874 cable connectors	0874-9902
874-T08 Crimping Tool, for GR874-()8A cable connectors	0874-9900
874-T058 Crimping Tool, for all other GR874 cable connectors	0874-9901



874-TOK

1. Outer-conductor wrench
2. Inner-conductor wrench
3. Coupling-nut wrench
4. Front-ring expander (red)
5. Keeper for ring expanders
6. Back-ring expander (green)
7. Ring pusher

874-T058 874-T08

GR874® Miscellany (Cont'd)

Air-Line Tube and Rod

Used to fabricate custom-length 14-mm air lines and components in conjunction with GR874, GR 880, and GR900® connectors.

Outer-Conductor Tube (50 and 75 Ω)

Mechanical: Bright-alloy-plated brass; ends grooved and slotted to accept 874-B, -BBL, 890-BT, 900-AB, -AC, -AP, -BT, and -BT (75 Ω) connectors. DIMENSIONS: 15.88 in. (403 mm) long x 0.624 \pm 0.000 \pm 0.002 in. OD.

50- Ω Inner-Conductor Rod

Electrical: IMPEDANCE: 50 \pm 0.1875 Ω (\pm 0.375%) when centered in the outer-conductor tube.

Mechanical: High-conductivity silver-plated brass; ends tapped to accept 874-B, -BBL, 890-BT, 900-AB, -AC, -AP, -BT and -BT (75 Ω) connectors. DIMENSIONS: 15.88 in. (403 mm) long x 0.24425 \pm 0.00025 in. dia.

75- Ω Inner-Conductor Rod **NEW**

Electrical: IMPEDANCE: 75 \pm 0.25 Ω (\pm 0.375%) when centered in the outer-conductor tube.

Mechanical: High-conductivity gold-plated brass; ends tapped to accept 874-B (75 Ω) and 900-BT (75 Ω) connectors. DIMENSIONS: 15.88 in. (403 mm) long x 0.24425 \pm 0.00025 in. dia.



Description

Catalog Number

Outer-Conductor Tube (50 and 75 Ω)

0874-9509

Inner-Conductor Rod

50- Ω
75- Ω

0874-9508
0874-9550

Smith Charts

Measurements made with slotted lines are facilitated by the use of Smith Charts; you can use them to determine the impedance that corresponds to any SWR and to convert from impedance to admittance and vice versa. Charts with normalized coordinates are for use with lines of any impedance. Charts with 50- Ω characteristic impedance (20-m Ω characteristic admittance) are directly applicable to all GR 50- Ω coaxial equipment.

Smith Charts

NORMALIZED COORDINATES

Type NX, 22.5x35 in. (571x889 mm), pad of 75 charts

5301-7563

Type N, 8.5x11 in. (216x279 mm), 50 charts

5301-7560

Type NE, expanded (for use when SWR \leq 1.58),

8.5x11 in., 50 charts

5301-7561

Type HE, highly expanded (for use when SWR

\leq 1.12), 8.5x11 in., 50 charts

5301-7562

50-OHM COORDINATES

Type Z, 8.5x11 in., 50 charts

5301-7569

20-MILLIMHO ADMITTANCE COORDINATES

Type Y, 8.5x11 in., 50 charts

5301-7568

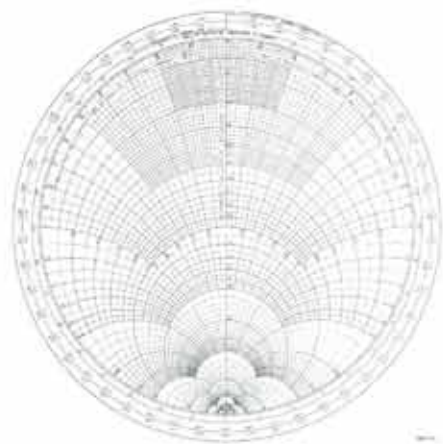

NX, N, Y, Z

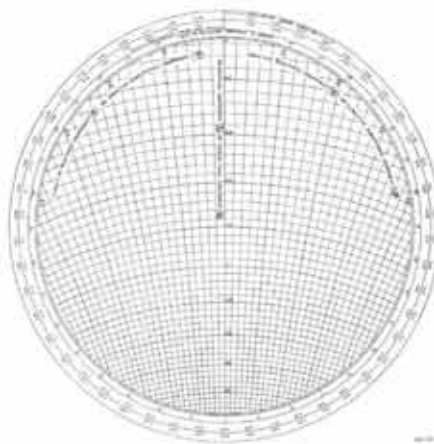

NE

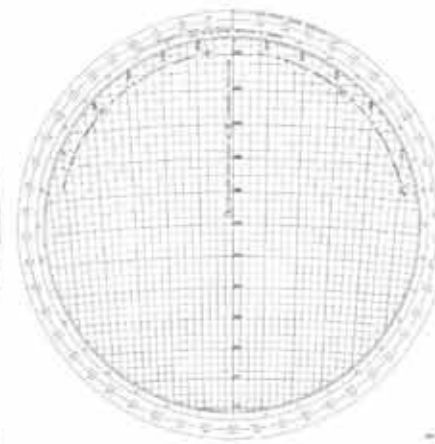

HE

RF Bridges

- broad range — 400 kHz to 500 MHz
- high directivity — 40 dB
- low-cost 50-ohm or 75-ohm models

New

These bridges combine small size and low price with high performance. They are excellent for use in general-purpose or specialized SWR- or reflection-measurement systems in research, calibration, standards, and maintenance applications.

Both the standard and unknown ports of these bridges are accessible. Normally, the standard port is terminated in an 874-W50 50-ohm or an 874-W75 (75 Ω) termination so that no degradation in directivity is encountered. For applications where structural return loss is important, a variable termination can be connected to the standard port. All ports are GR874® connectors and accept a wide variety of GR components to adapt the bridges to specific uses or measurement applications.

Frequency: 400 kHz to 500 MHz.

Directivity: 40 dB from 1 MHz to 500 MHz; 45 dB, 3 MHz to 450 MHz.

Electrical: IMPEDANCE: 50 or 75 Ω . INSERTION LOSS: 6 dB from load port (standard or unknown) to detector port, 6 to 10 dB from source port to load port.

Mechanical: DIMENSIONS: 3.75x6.25x1 in. (95x159x25 mm). WEIGHT: 0.8 lb (0.4 kg) net, 2 lb (1 kg) shipping.



RF Bridges

874-BR (50 Ω)
874-BR (75 Ω)

0874-9453
0874-9756

High-Frequency GR900[®] Precision Coaxial Components

The GR900[®] line of precision coaxial components consists of:

50-Ohm Connectors

Basic, cable, and panel connectors and connector kits

50-Ohm Adaptors

Adaptors to most popular connector types

50-Ohm Terminations and Attenuators

Short-circuit, open-circuit, and resistive terminations

Tuners

Fixed attenuators

50-Ohm Air Lines

Fixed air lines

75-Ohm Components NEW

Connectors, adaptors, and terminations

Miscellaneous

Ells, tools, cleaning kit, tube and rod



GR900® Precision Coaxial Components

The first precision series For many years it was difficult to improve the design of highly accurate high-frequency measuring equipment since any improvements were obscured by connector difficulties. This fact spurred General Radio, with its long experience in coaxial-connector development, to design the first commercial coaxial connector that could honestly be called "precision" — the GR900® connector.

A versatile choice The successful development of the GR900® connector signaled the initiation of an entire line of precision coaxial components and instruments. These, together with connector kits and precision rod and tubing, can bring GR900 precision to every corner of your laboratory.

Electrical characteristics One of the most important characteristics of a connector is standing-wave ratio and in the GR 900-BT connector $SWR < (1.001 + 0.001 f_{GHz})$. Of ever greater importance in many applications is connector repeatability because this sets the limit of measurement accuracy. The GR 900-BT connector offers repeatability of ± 0.002 dB in insertion loss, $\pm 0.008^\circ$ in insertion phase, and 0.05% in SWR.

Leakage of the GR900 connector is better than 130 dB below signal level — lower than that of any other commonly used coaxial connector. This remarkable characteristic is due to the triple shielding action of the butt contact between outer conductors, the interlocking and overlapping of the centering gear rings, the threaded engagement of the outer locking nut, and the precise machining of the mating surfaces. Insertion loss is extremely small, due to the unique design of the contacts and the use of very low-loss materials — Teflon* for the bead and solid-silver alloys for both inner and outer conductors.

Electrical length of a connector pair is 3.50 cm and is virtually independent of frequency. Dc resistance is typi-

cally 0.4 mΩ for the inner conductors and 0.04 mΩ for the outer conductors of a mated pair.

The 900-BT connector meets all specifications contained in Part III, Section 1 of the IEEE Standard for Precision Coaxial Connectors, No. 287. The connectors are available in pairs, each with a calibration certificate that verifies the combined SWR of the pair to be within the limits specified in the IEEE document.

Mechanical characteristics The spring contact and inner conductor are made of gold-plated solid-silver alloy; the bead support, Teflon; the centering gear ring, stainless steel; the outer conductor, gold-plated coin silver; the retaining ring, phosphor bronze; and the coupling and locking nuts, chrome-plated brass.

When the parts are assembled onto an air line, the coupling nut and retaining ring attach the outer conductor of the connector to the outer conductor of the line. The inner conductor is threaded into the center conductor of the air line and is supported by the Teflon bead.

When two connectors are mated, the centering gear rings interlock and overlap to center the connectors with respect to each other. The interlocking also prevents the connectors from rotating against each other (with possible impairment of repeatability and reliability). The front surfaces of the outer conductors meet at a common reference plane, where they butt firmly together under the pressure of the locking nut.

The front surface of the inner conductor is recessed 0.001 inch with respect to the reference plane of the outer conductor, to ensure outer-conductor contact. Inner-conductor contact is made by a springy center contact assembly that projects slightly beyond the reference plane of the outer conductor until the connector is mated. The spring contact assembly consists of six independently sprung segments that are forced back and together upon mating, thereby making a wiping contact with both the inside of the inner conductor and the mating face of the other center contact. This connector structure is free from the reflections that would be caused by slots in the inner and outer conductors. It will give you exceptionally long life, with excellent repeatability, in part because micro-abrasion of the rubbing surfaces cannot affect the electrically critical conductor diameters.

* Registered trademark of the E. I. du Pont de Nemours and Company.

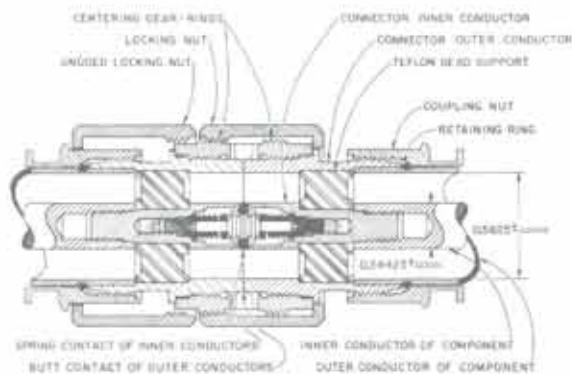

Cross-section view of mated 900-BT Precision Coaxial Connectors.

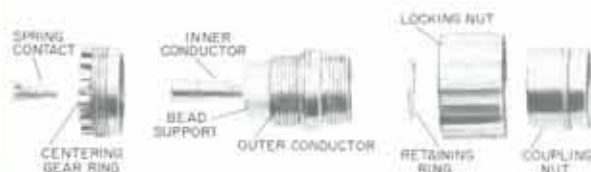

Exploded view of 900-BT Precision Coaxial Connector.

GR900® 50-Ohm Connectors

Basic Precision Connector

For use on rigid, 14-mm, air-dielectric 50- Ω coaxial lines (principal dimensions of 0.5625 in. and 0.24425 in.). The basic connectors are available as single connectors or as a pair of connectors with calibration certificate; the same SWR specification applies to either. These limits are those approved in the IEEE Recommended Practice for Precision Coaxial Connectors in the 14-mm general precision connector class. 900-BT Connectors are 100% tested at six frequencies. The 900-TOK Tool Kit is recommended for proper assembly.

Frequency: Dc to 8.5 GHz.

SWR: $\leq (1.001 + 0.001 f_{GHz})$ applies to single connectors and pairs.

Repeatability: SWR: Within 0.05%. **INSERTION LOSS:** ± 0.001 dB to 30 MHz, ± 0.002 dB to 1 GHz, ± 0.0025 dB to 8.5 GHz. **PHASE:** Within 0.008° at 1 GHz, 0.015° at 2 GHz, 0.05° at 6 GHz.

Electrical: **IMPEDANCE:** 50 $\Omega \pm 0.1\%$ at frequencies where skin depth is negligible. **INPUT VOLTAGE:** Up to 3000 V pk. **POWER** average into 50- Ω load: Up to 20 kW, dc to 1 MHz, decreasing as $1/\sqrt{f}$ at higher f. **INSERTION LOSS:** $< (0.003 \sqrt{f_{GHz}})$ dB per pair. **LEAKAGE:** > 130 dB below signal. **ELECTRICAL LENGTH:** 3.500 ± 0.005 cm per pair; 1.750 ± 0.0025

cm for single connector. **DC CONTACT RESISTANCE:** < 0.07 m Ω for outer conductor, < 0.5 m Ω for inner conductor.

Mechanical: **DIMENSIONS:** 1.19 in. (30 mm) long x 1.06 in. (27 mm) dia. **WEIGHT:** 0.2 lb (0.1 kg) net.

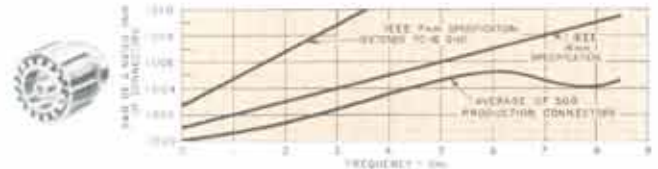

Typical and specified SWR of single and certified pairs of 900-BT Precision Coaxial Connectors. Specified SWR is identical to that given as IEEE Recommended Practice.

Description	Catalog Number
50-Ω Basic Precision Coaxial Connectors	
900-BT, single \oplus	0900-9405
900-BT, pair, with calibration certificate	0900-9407

Low-Cost Basic Precision Connector

For use on rigid, 14-mm, air-dielectric 50- Ω coaxial lines (principal dimension of 0.5625 in. and 0.24425 in.). The GR890 is a low-cost version of the GR900® precision coaxial connector and is intended for use when the lowest SWR is not required. Below 500 MHz, the difference in SWR, compared with the GR900, is insignificant; above 500 MHz, the SWR specification is somewhat degraded. For example, at 8 GHz the SWR specification is 1.019, compared with 1.009 for the GR900.

The GR 890 connector is generally used at lower frequencies on capacitance, inductance, or resistance standards, and at higher (microwave) frequencies where the SWR of the device is much greater than that of the connector. The other useful properties of the GR900 series, such as repeatability, well-defined reference plane, and low contact resistance, are retained. Grooves in the 890-BT locking nut distinguish the low-cost version from the 900-BT connector, but they mate without restriction.

Frequency: Dc to 8.5 GHz.

SWR: $< (1.003 + 0.002 f_{GHz})$ per connector. For mated connectors, add SWR specs, i.e., double this spec for pair of 890 connectors.

Repeatability: SWR: $\leq \pm 0.0005$ or $\pm 0.05\%$. **INSERTION LOSS:** ± 0.001 dB to 30 MHz, ± 0.002 dB to 1 GHz, ± 0.0025 dB to 8.5 GHz. **PHASE:** $\leq 0.008^\circ$ at 1 GHz, 0.015° at 2 GHz, 0.05° at 6 GHz.

Electrical: **IMPEDANCE:** 50 $\Omega \pm 0.3\%$ at frequencies where skin depth is insignificant. **INPUT VOLTAGE:** Up to 3000 V pk. **POWER**, average into 50- Ω load: Up to 20 kW, dc to 1 MHz, decreasing as $1/\sqrt{f}$ at higher f. **INSERTION LOSS:** $< (0.004 \sqrt{f_{GHz}})$ dB per pair. **LEAKAGE:** > 130 dB below signal. **ELECTRICAL LENGTH:** (3.500 $\pm 0.005 - 0.01$) cm per pair; (1.750 $\pm 0.0025 - 0.005$) cm for single connector. **DC CONTACT RESISTANCE:** < 0.07 m Ω for outer conductor, < 0.5 m Ω for inner conductor.

Mechanical: **DIMENSIONS:** 1.19 in. (30 mm) long x 1.06 in. (27 mm) dia. **WEIGHT:** 0.2 lb (0.1 kg) net.



50- Ω Low-Cost Basic Precision Coaxial Connector
890-BT, single **0890-9405**

Basic Precision Connector Kits

For custom fabrication of rigid, 14-mm, air-dielectric 50- Ω coaxial lines and terminations compatible with the GR900® connector. Rigid air lines can be made from GR900 Precision Rod (0900-9507) and Tube (0900-9509) to serve as precision capacitance or time-delay standards, as well defined reactance standards, and as dielectric sample holders for dielectric-constant and loss measurements with the slotted line. The connectors formed by these three kits are beadless.

900-AP for unsupported inner conductor The 900-AP is for use on elements that have unsupported inner conductors. A reference air line can be assembled from a pair of these kits and appropriate lengths of precision rod and tube. The kit consists of locking nut, centering gear ring, and a spring-loaded centering pin that allows the inner conductor of the resulting beadless air line to derive its support from the mating 900-BT Connector.

900-AC for supported inner conductor The 900-AC can be used in place of the 900-BT on any component whose inner conductor is supported within the component itself. The kit consists of locking nut, centering gear ring, and center contact of a standard GR900 connector. Since it includes only those parts necessary for its particular application, this kit

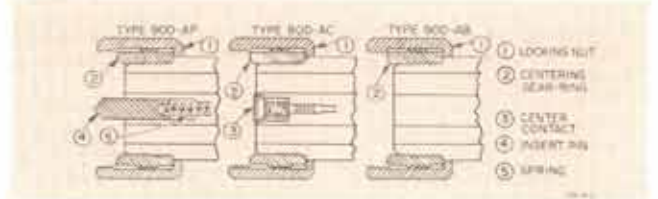

\oplus Federal stock numbers are listed before the index.

offers superior electrical performance at a considerable savings in cost.

900-AB for supported inner conductor, less center contact. The 900-AB can be used to fabricate an air line to be mated with a 900-BT Connector, but it cannot mate with a 900-LZ Reference Air Line or with another 900-AB or 900-AP Connector. The 900-AB is like the -AC in appearance and function, except it does not contain the center contact. Repeatability is specified in %; example: if SWR varies from 1.00012 to 1.00016 (for a pair mated successively), the repeatability is ± 0.00002 or $\pm 0.002\%$.

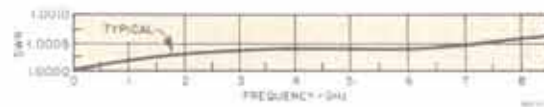

Description	Catalog Number
50-Ω Laboratory Precision Connector Kits	
900-AP, repeatability within $\pm(0.010 + 0.003 f_{GHz})\%$	0900-9406
900-AC, repeatability within $\pm 0.05\%$	0900-9404
900-AB, repeatability within $\pm(0.010 + 0.003 f_{GHz})\%$	0900-9402

Cable Precision Connectors

For use with more than 20 different RG types of coaxial cable. The SWR of these connectors is much lower than that of even the best-made cables. The braid retention system does not compress the cable, yet it has good pull and torque

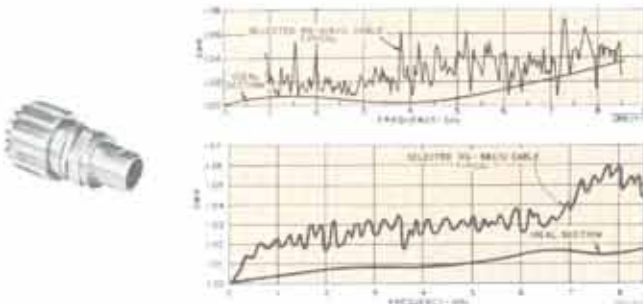

Typical SWR performance of a single Type 900-C9 Connector on an "infinite" length of RG-214/U cable and on an "ideal" section with the same diameters.

resistance. The usual distortion and flow of cable dielectric during inner-conductor soldering have been virtually eliminated by means of a Teflon spacer and a special, low-temperature solder supplied with every connector. All inner-conductor parts are captive and supported by a bead.

SWR of connector itself is represented by "ideal section" data (see curves) measured with precision coaxial line in place of cable.

Frequency: Dc to 8.5 GHz.

Electrical: IMPEDANCE: 50 Ω . INPUT VOLTAGE: Up to 1500 V pk for -C9; 500 V pk for -C58. INSERTION LOSS: $<(0.006 f_{GHz})$ dB per pair for -C9; $<(0.010 \sqrt{f_{GHz}})$ dB per pair for -C58.

50- Ω Coaxial Cable Precision Connectors

For RG-9B/U and RG-214/U cable; can be used, with some sacrifice in performance or mechanical reliability, with RG-8/U, -8A/U, -10A/U, -87A/U, -116/U, -156/U, -165/U, -166/U, -213/U, -215/U, -225/U, and -222/U:

900-C9

0900-9421

For GR 874-A3 and RG-58/U cable; has limited application with RG-29/U, -55/U, -141A/U, -142A/U, -159/U, and -233/U:

900-C58

0900-9431

Panel Mounting Kits

Used to mount standard GR 890 and GR900 connectors on a panel. Kit includes a threaded flange that accepts the outer conductor, mounting hardware, and a gear ring that, for the rotatable version, can be turned to permit any desired angular orientation of the mating connector.

Description	Catalog Number
Panel Mounting Kits	
900-PKM, non-rotatable	0900-9498
900-PKMR, rotatable	0900-9500

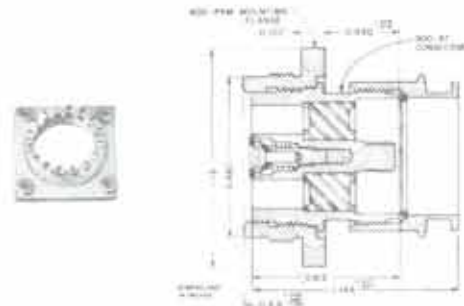

Rotatable Centering Ring

Permits proper mating with another GR 890 or GR900 connector in any orientation. Threads onto the connector in place of the regular centering gear ring.

Rotatable Centering Ring	0900-9499
--------------------------	-----------



Adaptor Flange

To connect GR900 components to instruments (like some bridges) that terminate in a broad plane surface and to a variety of flange-type connectors. This flange threads onto a 900-BT Connector in place of the centering gear ring and locking nut.



Adaptor Flange	0900-9782
----------------	-----------

GR900® 50-Ohm Adaptors

Conversion plus precision The availability of precision adaptors from the GR900® connectors to other popular coaxial connectors means that the user of GR900 equipped instruments can convert to other series and still retain precision performance. For example, a 900-LB Precision Slotted Line equipped with a 900-QNJ or -QNP adaptor becomes a

type N slotted line with an over-all residual SWR (line plus adaptor) of only 1.02 at 3 GHz. Conversely, users of instruments equipped with SMA, TNC, N, C, and GR874® connectors can, by means of adaptors, take advantage of the precision offered by GR900 tuners, airline standards, terminations, and other elements.

50-Ohm Precision Adaptor Kit

This set consists of the most commonly used GR900 precision adaptors including one each of the jack and plug versions of adaptors to BNC, C, N, SC, SMA, and TNC, as well as adaptors to Amphenol APC-7, Precifix AA, and GR874® connectors. All components are supplied in an attractive mahogany storage case with recessed foam inserts.

Mechanical: WEIGHT: 8 lb (3.7 kg) net, 12 lb (5.5 kg) shipping.

Description	Catalog Number
GR900 Precision Adaptor Set	0900-9451
GR900 Storage Case	0900-9450



Precision Adaptors to BNC

Two versions: One includes a BNC jack and the other includes a BNC plug. Both use a GR900 precision connector on the other end.

Frequency: Dc to 8.5 GHz.

SWR: $<(1.005 + 0.015 f_{GHz})$ to 1 GHz, $<(1.015 + 0.005 f_{GHz})$ to 8.5 GHz.

Electrical: IMPEDANCE: 50 Ω nominal. INPUT VOLTAGE: Up to 500 V pk. POWER, average into 50- Ω load: Up to 3 kW, dc to 1 MHz, decreasing as $1/\sqrt{f}$ at higher f.

Mechanical: WEIGHT: 0.3 lb (0.2 kg) net; 1.3 lb (0.6 kg) shipping.

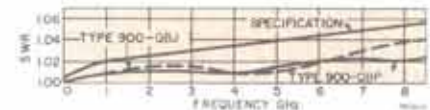

Description	Catalog Number
50- Ω Precision Adaptors to BNC 900-QBJ, with BNC jack	0900-9701
900-QBP, with BNC plug	0900-9801

Precision Adaptors to C

Two versions: One includes a type C jack and the other includes a type C plug. Both use a GR900 precision connector on the other end.

Frequency: Dc to 8.5 GHz.

SWR: $<(1.005 + 0.015 f_{GHz})$ to 1 GHz, $<(0.015 + 0.005 f_{GHz})$ to 8.5 GHz.

Electrical: IMPEDANCE: 50 Ω nominal. INPUT VOLTAGE: Up to 1000 V pk. POWER, average into 50- Ω load: Up to 7 kW, dc to 1 MHz, decreasing as $1/\sqrt{f}$ at higher f.

Mechanical: WEIGHT: 0.3 lb (0.2 kg) net; 1.3 lb (0.6 kg) shipping.



Description	Catalog Number
50- Ω Precision Adaptors to C 900-QCJ, with C jack	0900-9703
900-QCP, with C plug	0900-9803

Precision Adaptors to N

Two versions: One includes a type N jack and the other includes a type N plug. Both use a GR900 precision connector on the other end.

Frequency: Dc to 8.5 GHz.

SWR: $<(1.004 + 0.004 f_{GHz})$ to 8.5 GHz.

Electrical: IMPEDANCE: 50 Ω nominal. INPUT VOLTAGE: Up to 1000 V pk. POWER, average into 50- Ω load: Up to 7 kW, dc to 1 MHz, decreasing as $1/\sqrt{f}$ at higher f.

Mechanical: WEIGHT: 0.3 lb (0.2 kg) net; 1.3 lb (0.6 kg) shipping.

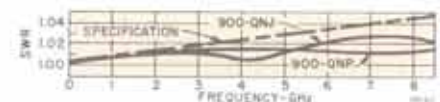

Description	Catalog Number
50- Ω Precision Adaptors to N 900-QNJ, with N jack	0900-9711
900-QNP, with N plug	0900-9811

† Federal stock numbers are listed before the Index.

Precision Adaptors to TNC

Two versions: One includes a TNC jack and the other includes a TNC plug. Both use a GR900 precision connector on the other end.

Frequency: Dc to 8.5 GHz.

SWR: $<(1.005 + 0.015 f_{GHz})$ to 1 GHz, $<(1.015 + 0.005 f_{GHz})$ to 8.5 GHz.

Electrical: IMPEDANCE: 50 Ω nominal. INPUT VOLTAGE: Up to 500 V pk. POWER, average into 50- Ω load: Up to 3 kW, dc to 1 MHz, decreasing as $1/\sqrt{f}$ at higher f.

Mechanical: WEIGHT: 0.3 lb (0.2 kg) net; 1.3 lb (0.6 kg) shipping.

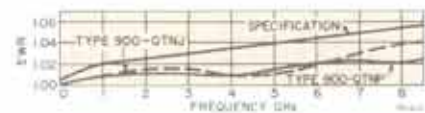

Description

Catalog Number

50- Ω Precision Adaptors to TNC
900-QTNJ, with TNC jack
900-QTNP, with TNC plug

0900-9717
0900-9817

Precision Adaptors to SMA

Two versions: One includes an SMA jack and the other includes an SMA plug. Both use a GR900 precision connector on the other end.

Frequency: Dc to 8.5 GHz.

SWR: $<(1.005 + 0.025 f_{GHz})$ to 1 GHz, $<(1.022 + 0.008 f_{GHz})$ to 8.5 GHz.

Electrical: IMPEDANCE: 50 Ω nominal.

Mechanical: WEIGHT: 0.3 lb (0.2 kg) net; 1.3 lb (0.6 kg) ship.

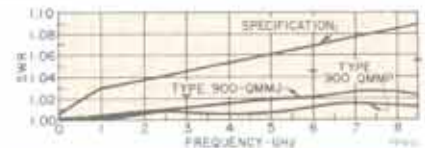

50- Ω Precision Adaptors to SMA
900-QMMJ, with SMA jack
900-QMMP, with SMA plug

0900-9723
0900-9823

Precision Adaptors to SC

Two versions: One includes an SC jack and the other includes an SC plug. Both use a GR900 precision connector on the other end.

Frequency: Dc to 8.5 GHz.

SWR: $<(1.005 + 0.015 f_{GHz})$ to 1 GHz, $<(1.015 + 0.005 f_{GHz})$ to 8.5 GHz.

Electrical: IMPEDANCE: 50 Ω nominal. INPUT VOLTAGE: Up to 1000 V pk. POWER, average into 50- Ω load: Up to 7 kW, dc to 1 MHz, decreasing as $1/\sqrt{f}$ at higher f.

Mechanical: WEIGHT: 0.3 lb (0.2 kg) net; 1.3 lb (0.6 kg) ship.



50- Ω Precision Adaptors to SC
900-QSCJ, with SC jack
900-QSCP, with SC plug

0900-9713
0900-9813

Precision Adaptors to 7-mm Precision

Includes an Amphenol APC-7 or R&S 7-mm connector on one end and a GR900 precision connector on the other.

Frequency: Dc to 8.5 GHz.

SWR: $<(1.003 + 0.003 f_{GHz})$ to 8.5 GHz.

Electrical: IMPEDANCE: 50 Ω nominal. INPUT VOLTAGE: Up to 1000 V pk. POWER, average into 50- Ω load: Up to 6 kW, dc to 1 MHz, decreasing as $1/\sqrt{f}$ at higher f. ELECTRICAL LENGTH: 5.30 ± 0.02 cm.

Mechanical: WEIGHT: 0.3 lb (0.2 kg) net; 1.3 lb (0.6 kg) ship.



50- Ω Precision Adaptor to 7-mm Precision
900-QAP7, with APC-7 connector
900-QPF7, with R&S 7-mm connector

0900-9791
0900-9793

Precision Adaptor to GR874® Connector

Includes a locking GR874 connector on one end and a GR900 precision connector on the other.

Frequency: Dc to 8.5 GHz.

SWR: $<(1.00 + 0.015 f_{GHz})$ to 1 GHz, $<(1.010 + 0.005 f_{GHz})$ to 8.5 GHz.

Electrical: IMPEDANCE: 50 Ω nominal. INPUT VOLTAGE: Up to 1500 V pk. POWER, average into 50- Ω load: Up to 10 kW, dc to 1 MHz, decreasing as $1/\sqrt{f}$ at higher f.

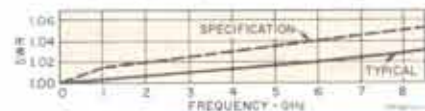

50- Ω Precision Adaptor to GR874
900-QB74, with locking GR874 connector

0900-9883

Precision Adaptor to Binding Posts

One convertible version: Adapts binding posts (spaced on 0.75- to 1-in. centers) to GR900 connector and (after a simple mechanical modification) adapts GR900 connector to binding posts. Particularly useful for converting "unknown" terminals of bridges.

Electrical: RESIDUAL IMPEDANCE: When binding posts are adapted to GR900, ≈ 3.55 pF and ≈ 4.8 nH are added to terminals. When GR900 is adapted to binding posts, ≈ 5.2 pF

and ≈ 11 nH are added at base and ≈ 20 nH at top of binding posts.

Mechanical: WEIGHT: 0.3 lb (0.2 kg) net; 1.3 lb (0.6 kg) ship.



50- Ω Precision Adaptor to Binding Posts
900-Q9

0900-9874

Ⓢ Federal stock numbers are listed before the Index.

GR900® 50-Ohm Precision Terminations and Attenuators

Precision Resistive Terminations and Mismatches

Standard terminations are useful for calibration of bridges, slotted lines, admittance bridges, network analyzers, and reflectometers. The 50-ohm 900-W50 termination can also be used as a precision dummy load or as a termination in measurements of networks with more than one port. This termination, together with the 900-WNC Short Circuit and 900-LZ Air Lines, can form a calibration set for computer correction of measuring instruments. With an appropriate GR900 adaptor, it can be used as a low-SWR, precision type-N termination, or BNC, or C, etc.

Standard mismatches introduce reflections of known SWR in a 50-ohm transmission line and are therefore useful in the calibration of reflectometers, network analyzers, and SWR-measuring instruments.

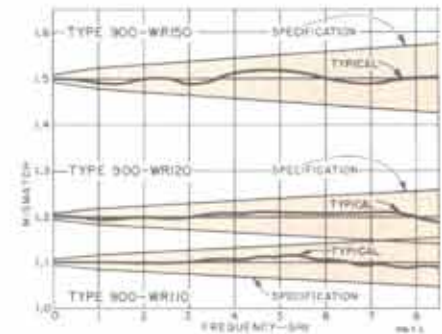
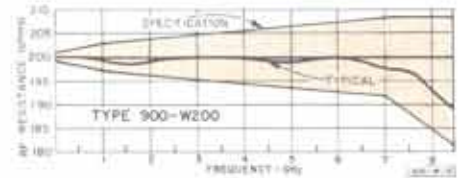
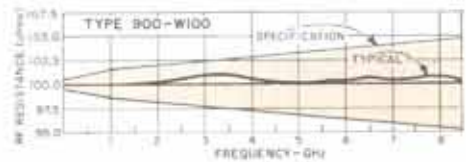
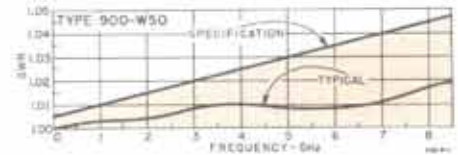

Frequency: Dc to 8.5 GHz.

900	-W50	-W100	-W200	-W110	-W120	-W150
Dc						
Resistance:	50 Ω	100 Ω	200 Ω	45.45 Ω	41.67 Ω	33.33 Ω
Accuracy:	±0.3%	±0.5%	±0.5%	±0.5%	±0.5%	±0.5%
SWR, also see curves:	1.005 + 0.005 fMHz	—	—	1.1 nom	1.2 nom	1.5 nom
Plane Position*:	—	4 cm nom	4 cm nom	—	—	—

Electrical: INPUT POWER: <1 W with negligible change, <5 W without damage. TEMPERATURE COEFFICIENT: <150 ppm/°C.

Mechanical: DIMENSIONS: 2 in. (51 mm) long x 1.06 in. (27 mm) dia. WEIGHT: 0.2 lb (0.1 kg) net.

Description	Catalog Number
Precision Resistive Terminations	
900-W50 50-Ω Standard Termination	0900-9953
900-W100 100-Ω Standard Termination	0900-9957
900-W200 200-Ω Standard Termination	0900-9959
Precision Mismatches:	
900-WR110 Standard Mismatch, SWR 1.1	0900-9961
900-WR120 Standard Mismatch, SWR 1.2	0900-9963
900-WR150 Standard Mismatch, SWR 1.5	0900-9965

Open-Circuit Terminations

Open-circuit terminations are useful in establishing initial conditions of line length and signal phase, as shielding caps for open-circuited lines, and, at low frequencies, as capacitance standards.

Frequency: Dc to 8.5 GHz.

Plane Position*: For 900-WO, typically 0.26 cm, but varies with frequency within ±0.012 cm of value shown on graph. For -WO4, 4.00 ± 0.01 cm (corresponds to 4-cm offset in 900-W100 and -W200 Standard Terminations).

Electrical: CAPACITANCE: 0.172 ± 0.008 pF for -WO, at low frequencies; 2.670 pF ± 0.25% for -WO4, below 70 MHz.



900-WO4

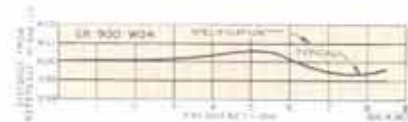

900-WO

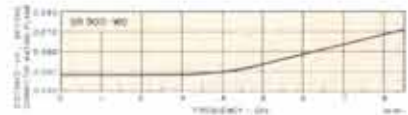

Description	Catalog Number
Precision Open-Circuit Terminations	
900-WO, plane at 2.6 mm	0900-9981
900-WO4, plane at 4 cm	0900-9985

* Location of effective position of termination, measured toward "load", from reference plane of connector (where outer conductors butt together).

Precision Short-Circuit Terminations

Short-circuit terminations are useful in establishing initial conditions of line length and signal phase in, for example, impedance measurements. An s-c termination consists of a precision-machined, silver-plated disk, mounted in a centering gear ring and locking-nut assembly, to produce a fixed short circuit. The 900-WNC, -WNE, and -WN4 each includes a support for one end of the inner conductor of a 900-LZ Reference Air Line, which is beadless.

Frequency: Dc to 8.5 GHz.

Plane Position:* For 900-WN and -WNC, 0.00 cm; for 900-WNE, 0.26 ± 0.005 cm (corresponding open circuit is 900-WO); for 900-WN4, 4.00 ± 0.01 cm (corresponding resistive terminations are 900-W100 and -W200).

Reflection Coefficients: >0.999 for -WN and -WNC, >0.998 for -WNE, >0.996 for -WN4; all to 8.5 GHz.

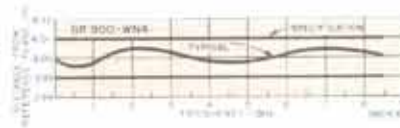

Description

Catalog Number

50- Ω Precision Short-Circuit Terminations

900-WN, without support, plane at 0.00 cm	0900-9971
900-WNC, with support, plane at 0.00 cm	0900-9977
900-WNE, with support, plane at 2.6 mm	0900-9979
900-WN4, with support, plane at 4 cm	0900-9975

Precision Tuner

Used to match out small residual reflections in low-SWR measuring instruments and devices. The tuner has three smoothly adjustable tuning screws that are used in pairs to tune out reflections of any phase throughout the tuner's frequency range. Each screw has a "neutral" setting, independent of frequency, at which it is effectively out of the circuit. Screws can be locked at any setting to enhance the excellent SWR resetability and to protect against accidental disturbance. They can be partially clamped for the desired friction.

Frequency: 1 to 8.5 GHz.

SWR Matching Range: 1.00 to $1.00 + 0.012 f_{GHz}$, worst-case minimum. RESETTABILITY: $<(1.0005 + 0.0003 f_{GHz})$.

Repeatability: 0.05% (limited by connector).

Electrical: IMPEDANCE: 50 Ω nominal. INSERTION LOSS: <0.1 dB to 4 GHz, <0.3 dB to 8.5 GHz. ELECTRICAL LENGTH: 12.0 cm.

Mechanical: DIMENSIONS: 4.5x3.5x1 in. (114x89x25mm). WEIGHT: 1 lb (0.5 kg) net, 3 lb (1.4 kg) shipping.

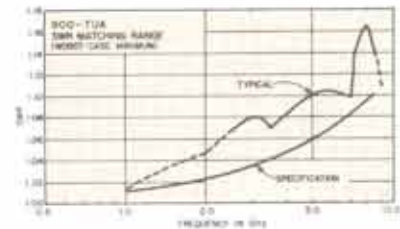
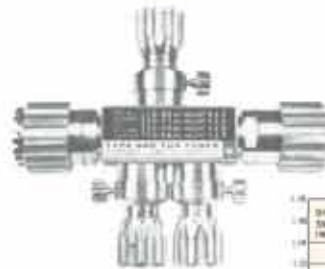

900-TUA Tuner

0900-9635

Precision Fixed Attenuators

GR900 attenuators permit greatly improved accuracy in the measurement of insertion loss, impedance, power, or phase, which requires precise impedance matching of the source and detector. In particular, they are ideal for swept measurements of these quantities. In point-by-point measurements, they reduce or eliminate the need to tune out residual reflections from source or detector.

The SWR characteristic of these attenuators is much lower than was previously available, and they exhibit uniform attenuation over a wide frequency range. They display a high degree of repeatability in SWR, contact resistance, and insertion loss, factors that contribute to their value in substitution measurements. The high repeatability and low SWR also permit them to be accurately calibrated for use as attenuation standards.

Frequency: Dc to 8.5 GHz.

Attenuation Accuracy: ± 0.04 dB at dc, ± 0.2 dB to 5 GHz, ± 0.3 dB to 8.5 GHz. TEMPERATURE COEFFICIENT: <0.0001 dB/ $^{\circ}$ C/dB.

SWR: $<(1.005 + 0.005 f_{GHz})$.

Electrical: IMPEDANCE: 50.0 Ω . INPUT POWER: <1 W continuous, or <500 W peak with <1 W average. DC RESISTANCE: 50.0 $\Omega \pm 0.3\%$ when terminated in 50.0 Ω .
Mechanical: DIMENSIONS: 3.75 in. (95 mm) long. WEIGHT: 0.7 lb (0.4 kg) net.



Description

Catalog Number

50- Ω Precision Fixed Attenuators:	0900-9850
900-G6, 6 dB	0900-9851
900-G10, 10 dB	

* Federal stock numbers are listed before the index.

* Location of effective position of termination, measured toward "load", from reference plane of connector (where outer conductors butt together).

GR900® 50-Ohm Precision Air Lines

Reference-Air-Line Set

This set consists of one each of the seven lengths of 900-LZ Reference Air Lines, a 900-WN4 short circuit, and a 900-WO4 open circuit. All components are supplied in an attractive mahogany storage case, with recessed foam insets, which also can be supplied separately.

Mechanical: WEIGHT: 8 lb (3.7 kg) net, 13 lb (6 kg) shipping.

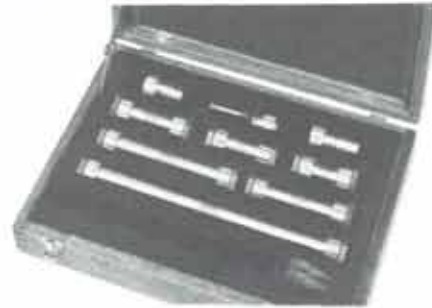

Description	Catalog Number
GR900 Reference-Air-Line Set	0900-9452
GR900 Storage Case	0900-9450

Reference Air Lines



For use in calibrations, especially in substitution measurements, as precision capacitance or time-delay standards, as well defined reactance standards, as dielectric sample holders for dielectric-constant and loss measurements with slotted lines and network analyzers, and as absolute impedance references in time-domain reflectometry. The 900-LZ series are beadless, virtually reflectionless coaxial air lines, with spring-loaded supporting tips on the ends of the inner conductor to mate with GR900 connectors; microfinished outer-conductor ends make butt contact with the mating connectors.

Frequency: Dc to 8.5 GHz.

SWR: $<(1.0005 + 0.0002 f_{GHz})$; calibration data supplied.

Repeatability: SWR: Within $(0.010 + 0.003 f_{GHz})\%$.

Electrical: IMPEDANCE: $50 \Omega \pm 0.05\%$ at 23°C and where skin depth is negligible. Additional skin-effect error is calculable.¹ INPUT VOLTAGE: Up to 3000 V pk. POWER, average into 50- Ω load: Up to 20 kW, dc to 1 MHz, decreasing as

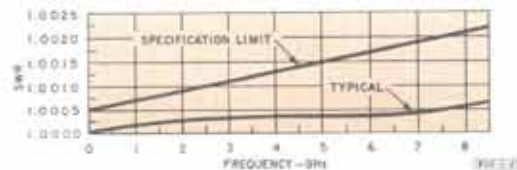

$1/\sqrt{f}$ at higher f . INSERTION LOSS: $<(0.0008 \sqrt{f_{GHz}})$ dB/cm. LEAKAGE: >130 dB below signal. DC CONTACT RESISTANCE each end, when mated with GR900 connector: <0.07 m Ω for outer conductor, <0.5 m Ω for inner conductor.

50- Ω Reference Air Lines

Type	Electrical Length (± 0.002 cm)	Capacitance ($\pm 0.07\%$) pF	Time Delay (± 0.1 ps) ps	Odd $\lambda/4$ Frequencies* GHz	Catalog Number
900-LZ3	2.998	2.0000	100.0	(2n+1) 2.50	0900-9603
900-LZ5	4.997	3.3333	166.7	(2n+1) 1.50	0900-9600
900-LZ6	5.996	4.0000	200.0	(2n+1) 1.25	0900-9601
900-LZ7H	7.495	5.0000	250.0	(2n+1) 1.00	0900-9602
900-LZ10	9.993	6.6667	333.3	(2n+1) 0.75	0900-9604
900-LZ15	14.990	10.0000	500.0	(2n+1) 0.50	0900-9606
900-LZ30	29.979	20.0000	1000.0	(2n+1) 0.25	0900-9612

* Frequencies at which air-line section is an odd multiple of a quarter wavelength, where n is zero or any integer).

Precision Air Lines



Useful as low-SWR line extenders, as 50-ohm impedance standards at frequencies at which the electrical length is an odd multiple of a quarter wavelength, as capacitance and time-delay standards, and as absolute impedance standards in time-domain reflectometry. Each line consists of a short section of precision 50-ohm air line with a GR900 connector at each end.

Frequency: Dc to 8.5 GHz.

SWR: $<(1.0013 + 0.0013 f_{GHz})$.

Electrical: IMPEDANCE: $50 \Omega \pm 0.065\%$. Additional skin-effect error is calculable.¹ INPUT VOLTAGE: Up to 3000 V pk. POWER, average into 50- Ω load: Up to 20 kW, dc to 1 MHz, decreasing as $1/\sqrt{f}$ at higher f . DC CONTACT RE-

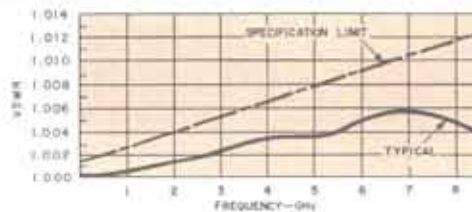

SISTANCE each end, when mated with GR900 connector: <0.07 m Ω for outer conductor, <0.5 m Ω for inner conductor.

50- Ω Precision Air Lines

Type	Electrical Length (± 0.02 cm)	Capacitance pF	Time Delay (± 1 ps) ps	Insertion Loss dB	Catalog Number
900-L3	3	2.0000	100	$<0.005 \sqrt{f_{GHz}}$	0900-9608
900-L10	10	6.6667	333	$<0.012 \sqrt{f_{GHz}}$	0900-9605
900-L15	15	10.000	500	$<0.016 \sqrt{f_{GHz}}$	0900-9607
900-L30	30	20.000	1000	$<0.028 \sqrt{f_{GHz}}$	0900-9613

¹ J. Zorzy, "Skin-Effect Corrections in Standards," *IEEE Transactions on Instrumentation and Measurement*, Vol. IM-15 No. 4, December 1966, p. 358 (GR Reprint A-134).

GR900® 75-Ohm Components

New Since
Catalog U

New versatility. A new series of GR900® general-purpose coaxial components extends the versatility of the line to the field of 75-ohm transmission-line measurements. The series includes matching pads and adaptors to permit direct conversion of existing 50-ohm systems to the 75-ohm capability.

The GR900 75-ohm components use a connector similar to the 50-ohm counterpart except for an identifying black coupling nut and modified inner conductor and insulating bead. Performance for the new components is specified up to 1 GHz but they are useful to 8.5 GHz or higher.

Basic Precision Connector

For use on rigid, 14-mm, air-dielectric, 75- Ω coaxial lines or with capacitance, inductance, and resistance standards.

Frequency: Dc to 1 GHz, usable to 9 GHz.

SWR: $< (1.0015 + 0.0015 f_{GHz})$.

Repeatability: SWR: ± 0.0006 ($\pm 0.06\%$). **INSERTION LOSS:** ± 0.001 dB to 30 MHz, ± 0.002 dB to 1 GHz. **PHASE:** 0.01° at 1 GHz.

Electrical: IMPEDANCE: $75 \Omega \pm 0.3\%$. **INPUT VOLTAGE:** Up to 3000 V pk. **POWER:** average into matched load: Up to 18 kW, dc to 1 MHz, decreasing as $1/\sqrt{f}$ at higher f . **INSERTION LOSS:** $< 0.004 \sqrt{f_{GHz}}$ per pair. **LEAKAGE:** > 130 dB below signal. **ELECTRICAL LENGTH:** Nom 1.75 cm (3.5 cm, mated pair); exactly 1.7488 ± 0.0038 cm (3.4976 ± 0.0076 cm). **DC CONTACT RESISTANCE:** < 0.07 m Ω for outer conductor, < 0.5 m Ω for inner conductor.

Mechanical: DIMENSIONS: 1.19 in. (30 mm) long x 1.06 in. (27 mm) dia. **WEIGHT:** 0.2 lb (0.1 kg) net, 1 lb (0.5 kg) shipping.



Description

900-BT (75- Ω) Precision Coaxial Connector

Catalog
Number

0900-9730

Precision Adaptors to Type F

Two adaptors are available; one includes a type F jack and the other includes a type F plug. Each uses a GR900 (75- Ω) connector on the other end. Type F jacks are designed for use with 0.023-in. dia (0.58 mm) wire.

Frequency: Dc to 1 GHz.

Electrical: IMPEDANCE: 75 Ω nominal.

Mechanical: DIMENSIONS: 0900-9738 1.92 in. (49 mm) long; 0900-9739 1.75 in. (44 mm) long; either, 1.06 in. (27 mm) dia. **WEIGHT:** 0.2 lb (0.1 kg) net, 1 lb (0.5 kg) shipping.

Description

Catalog
Number

75- Ω Adaptors to F

900-QFJ (75- Ω), with type F jack

900-QFP (75- Ω), with type F plug

0900-9738

0900-9739

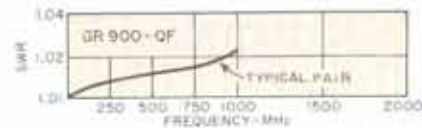

99-111-1

Precision Adaptors to Large WE

Two adaptors are available; one includes a large Western Electric jack and the other includes a large Western Electric plug. Each uses a GR900 (75 Ω) locking connector on the other end.

Frequency: Dc to 1 GHz.

Electrical: IMPEDANCE: 75 Ω nominal.

Mechanical: DIMENSIONS: 0900-9736 3.4 in. (86 mm) long; 0900-9737 2.9 in. (74 mm) long; either, 1.06 in. (27 mm) dia. **WEIGHT:** 0.2 lb (0.1 kg) net, 1 lb (0.5 kg) shipping.

75- Ω Adaptors to Western Electric, large

900-QWJL (75- Ω), with large WE jack

900-QWPL (75- Ω), with large WE plug

0900-9736

0900-9737

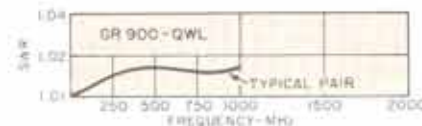

99-111-1

Precision Adaptors to Small WE

Two adaptors are available; one includes a small Western Electric jack and the other includes a small Western Electric plug. Each uses a GR900 (75- Ω) locking connector on the other end.

Frequency: Dc to 1 GHz.

Electrical: IMPEDANCE: 75 Ω nominal.

Mechanical: DIMENSIONS: 0900-9734 2.89 in. (73 mm) long; 0900-9735 2.62 in. (67 mm) long; either, 1.06 in. (27 mm) dia. WEIGHT: 0.2 lb (0.1 kg) net, 1 lb (0.5 kg) shipping.

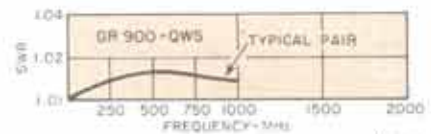

Description	Catalog Number
75- Ω Adaptors to Western Electric, small 900-QWJS (75- Ω), with small WE jack	0900-9734
900-QWPS (75- Ω), with small WE plug	0900-9735

Precision Adaptor, 75- to 50-Ohm GR900

Includes a GR900 (50- Ω) connector on one end and a GR900 (75- Ω) connector on the other end. It is a mechanical adaptor for the conversion from GR900 50-ohm connectors to GR900 75-ohm connectors (it is not an impedance transformer; see 900-MP below).

Frequency: Dc to 1 GHz, usable to 8.5 GHz.

Electrical: IMPEDANCE: 50 $\Omega \pm 0.3\%$ for 50- Ω side; 75 $\Omega \pm 0.5\%$ for 75- Ω side. LEAKAGE: > 130 dB below signal. ELECTRICAL LENGTH: 4 ± 0.01 cm for 50- Ω side; 0.24 ± 0.005 cm for 75- Ω side.

Mechanical: DIMENSIONS: 1.66 in. (42 mm) long x 1.06 in. (26 mm) dia. WEIGHT: 0.2 lb (0.1 kg) net, 1 lb (0.5 kg) shipping.



Description	Catalog Number
900-Q75 Precision Adaptor, 50 to 75- Ω	0900-9731

75- to 50-Ohm Precision Matching Pad

A two-port minimum-loss network to match 50-ohm GR900-equipped devices to similarly equipped 75-ohm devices. It features low SWR, low leakage, and the excellent repeatability inherent in GR900 connectors.

Frequency: Dc to 1 GHz, usable to 8.5 GHz.

SWR: Better than 1.003 + 0.003 f_{GHz} for 50- Ω side, 1.01 + 0.012 f_{GHz} for 75- Ω side.

Electrical: IMPEDANCE: 50 Ω and 75 Ω . INPUT: 1 W max continuous. INSERTION LOSS: 5.72 dB nominal. LEAKAGE: > 130 dB below signal.

Mechanical: DIMENSIONS: 3.75 in. (95 mm) long x 1.06 in. (27 mm) dia. WEIGHT: 0.6 lb (0.3 kg) net, 2 lb (1 kg) shipping.



900-MP 50 to 75- Ω Precision Matching Pad	0900-9732
--	-----------

Precision 75-Ohm Termination

A fixed 75- Ω resistor mounted in a GR900 (75 Ω) connector for establishing reference conditions in coaxial lines, for impedance matching, for use as a termination, for the calibration of bridges, slotted lines, and reflectometers, and for use as a dummy load in network measurements.

Frequency: Dc to 1 GHz, usable to 9 GHz.

SWR: < (1.005 \pm 0.005 f_{GHz}).

Electrical: IMPEDANCE: 75 $\Omega \pm 0.3\%$, temperature coefficient < 150 ppm/ $^{\circ}$ C. INPUT: 1 W with negligible change, 5 W without damage.

Mechanical: DIMENSIONS: 1.83 in. (47 mm) long x 1.06 in. (27 mm) dia. WEIGHT: 0.2 lb (0.1 kg) net, 1 lb (0.5 kg) shipping.



900-W75 (75- Ω) Precision Standard Termination	0900-9733
--	-----------

GR900® Miscellaneous

50-Ohm Precision 90° Ell

Permits coaxial devices, such as vertical liquid-dielectric sample holders, to be physically oriented as required, with better electrical performance than could be obtained with flexible cable.

Frequency: Dc to 8.5 GHz.

SWR: $<(1.004 + 0.004 f_{GHz})$.

Electrical: IMPEDANCE: $50 \Omega \pm 0.4\%$ at frequencies where skin depth is small. INPUT VOLTAGE: Up to 1500 V pk. POWER, average into 50- Ω load: Up to 10 kW, dc to 1 MHz, decreasing as $1/\sqrt{f}$ at higher f. INSERTION LOSS: $(0.017 \sqrt{f_{GHz}})$ dB. ELECTRICAL LENGTH: $[10.00 + 0.0014 (f_{GHz})^2 \pm 0.02]$ cm.

Mechanical: Gear rings rotatable, for proper mating in any orientation. MATING DIMENSIONS: 2.066 in. (5.246 mm) from center line of one connector to reference plane of other connector. OVER-ALL DIMENSIONS: 2.69x2.69x0.88 in. (68x68x22 mm). WEIGHT: 0.7 lb (0.3 kg) net.

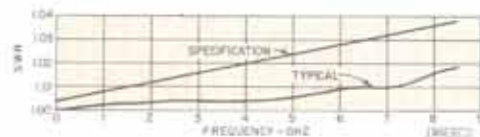

Description

900-EL Precision 90° Ell

Catalog Number

0900-9527

Tool Kit

Nine-piece tool kit in fitted case for convenient installation of 890-BT, 900-BT, 900-C58, and 900-C9 50-ohm precision coaxial connectors. With 0900-9904 accessory tools, the kit can also be used for 900-BT (75 Ω) connectors. Complete instructions are included.

Mechanical: WEIGHT: 7 lb (3.2 kg) shipping.

Description

900-TOK Tool Kit

Accessory Tools, for use with 900-TOK on 900-BT (75 Ω) connectors

Catalog Number

0900-9902

0900-9904



Storage Case and Cleaning Kit

Storage Case

An attractive mahogany case with firm, foamed plastic inserts having molded recesses designed to hold various types of GR900® precision coaxial components. An excellent way to keep together a set of adaptors, air lines, terminations, and the like and to carry or store them with minimum exposure to dirt or damage to the precision machined surfaces.

Mechanical: WEIGHT: 8 lb (3.7 kg) shipping.

Cleaning Kit

For cleaning both 50-ohm and 75-ohm GR900 connectors. Solvent supplied in 16-oz aerosol will not affect insulator nor any metal surface in these connectors. Kit also includes two brushes and 24 lint-free wiping pads.

GR900 Storage Case

900-TOC Cleaning Kit

0900-9450

0900-9610



Precision Tube and Rod

Used to fabricate custom-length 14-mm air lines and components in conjunction with GR900 connectors and connector kits. Machining instructions are furnished.

Precision Outer-Conductor Tube

Mechanical: Precision-forged, silver-lined brass; stress relieved to minimize dimensional changes during machining; for use with 890-BT, 900-AB, -AC, -AP, -BT, and -BT (75 Ω) connectors. DIMENSIONS (diameters specified at 23°C): 27 in. (690 mm) long, 0.830 in. nominal OD, 0.5625 in. \pm 220 μ in. ID with straightness of 0.005 in./ft and inner-surface finish of 30 μ in. max, 0.134 in. nominal wall thickness.

50- Ω Precision Inner-Conductor Rod

Electrical: IMPEDANCE: $50 \pm 0.035 \Omega$ ($\pm 0.07\%$) when centered in 0900-9509 tube.

Mechanical: Supplied in pairs; centerless-ground, silver-layered brass rod; for use with 890-BT, 900-AB, -AC, -AP, and -BT connectors. DIMENSIONS (diameters specified at 23°C): 13 \pm 0.0312 in. (330 mm) long with straightness of 0.0015 in./ft; 0.24425 in. \pm 65 μ in. dia with uniformity of $\pm 25 \mu$ in. and surface finish of 20 μ in. max.



Precision Outer-Conductor Tube
50- Ω Precision Inner-Conductor Rod

0900-9509

0900-9507

Stroboscopes

Useful data from useless blurs!

A strobe makes the difference and GR makes the strobe — nine of them in fact, plus a broad selection of accessories to tailor them for nearly any general-purpose or specialized use. Custom models and generous quantity discounts make GR strobes particularly attractive in

OEM applications. Stroboscopy is the simplest, most versatile, and most economical principle of motion analysis ever devised. GR has refined the principle to one of the most thoroughly engineered and most comprehensive lines of strobe equipment available anywhere.

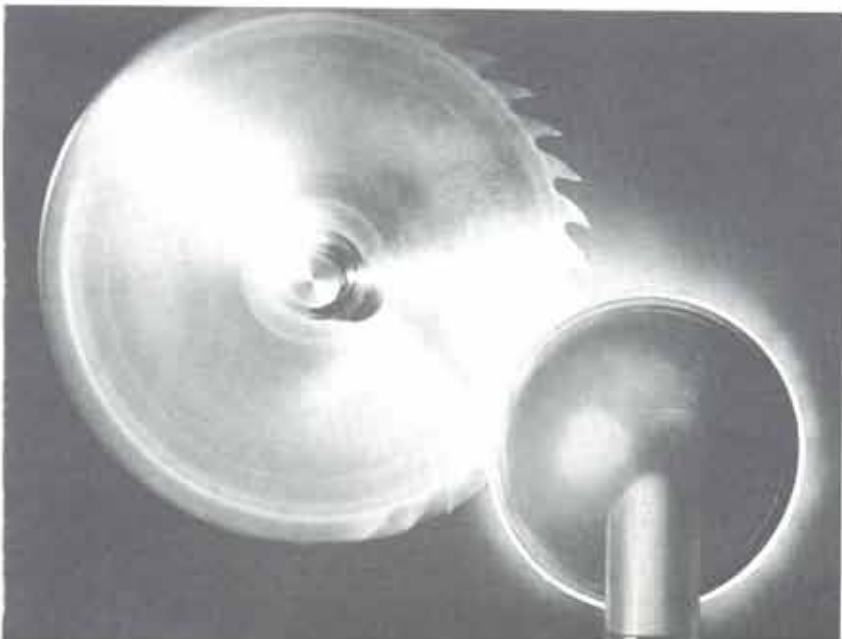
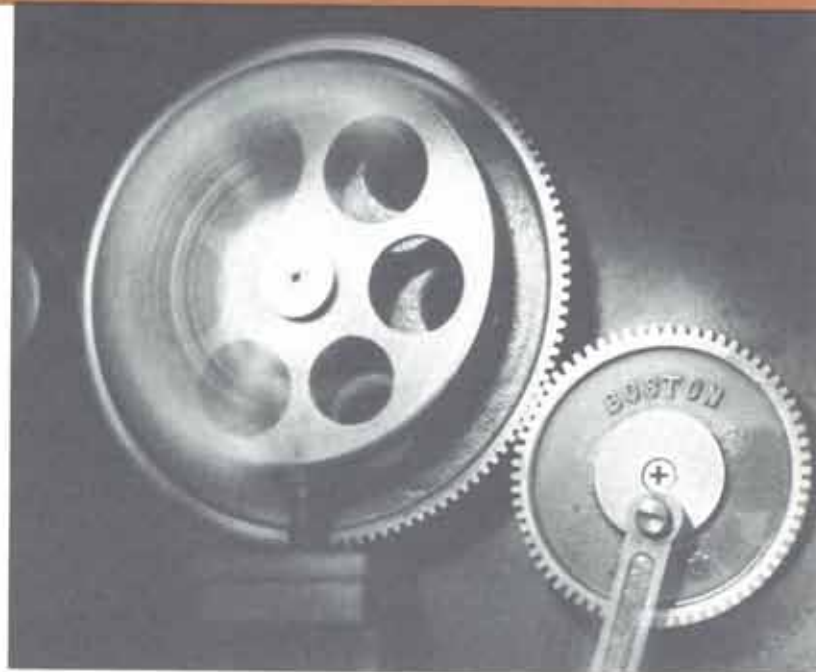
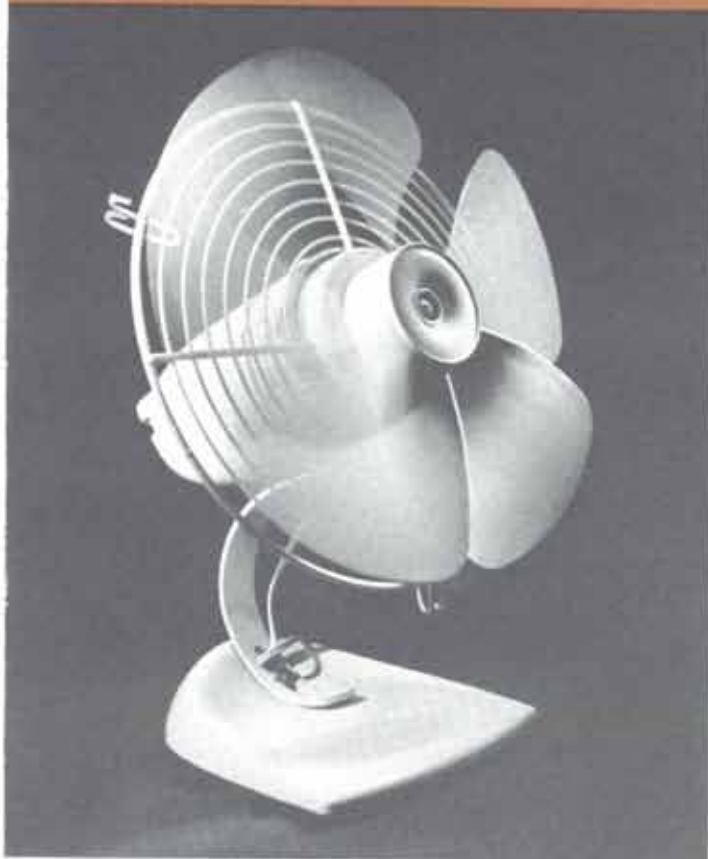

Strobe Selection

In principle, all strobes are basically the same — they are very bright, flashing lights normally used to observe action that is too fast to be seen by the unaided eye. When a strobe is aimed at a repetitive action and its flash rate is set to the same speed as the action (or some integer submultiple of it), the action appears stopped. It can be easily viewed, analyzed, and even measured, thanks to the stroboscope.

In practice, strobes differ significantly in their characteristics in order to match more exactly the requirements of a wide variety of applications. They also differ from one manufacturer to another in such important aspects as flash quality and reliability, attention to engi-

neering and production details, and applications and service assistance. A properly chosen strobe can be an invaluable asset in your application and will undoubtedly reap benefits well in excess of its purchase price.

Since the matter of selection is important, we have tabulated a summary of broad application areas with the appropriate strobes and their features. Later pages give you detailed descriptions of their individual characteristics. We also have an extensive library on stroboscopy, and we provide free advice and technical assistance from offices located throughout the world. Inquire about our 15-day free trial on any of our strobe equipment.

Application	Appropriate GR Strobe	Features Useful in The Application
Education		Strobes help demonstrate certain laws of physics, relations between frequency and wavelength, finite velocity of light, effects of combining colors, properties of standing waves, and the laws of gravity. Use a strobe for studies of velocity, acceleration, and energy transfer, or the principles of stroboscopy itself.
Physics lab	1543 1542	Low cost, accurate time base, external triggering for stable synchronization. Excellent where economy is important; uncalibrated time base.
Mechanical engineering	1539-A with 1531-P2 1544 1531-AB	Wide-range trigger delay for optimum image positioning, detachable lamp. Economical where normal-range trigger delay is adequate; fixed lamp. Accurate calibration enables you to measure rpm.
Electrical engineering	1531-AB or 1538	Accurate calibration — a must for torque/speed measurements.
Chemistry, biology, psychology, etc	1531-AB 1543 or 1544	Accurate calibration for precise speed or time measurements. More economical where accurate calibration is not required.
Textiles		The high operating speeds in the textile industry make the strobe almost mandatory. Its versatility permits rapid checks on spindle operation, twist loss, travelers and twisters, pattern pickage, dobby head, harness cams and motion, shuttle flight and arm tension, boxing and picking, filling transfer and ring-up bobbin ejection, hopper-stand setting, rapier action, filling transfer, and pickage in shuttleless looms, let-off and takeup, power-arm operation and adjustment, and condition, meshing and running of gears.
Shuttle looms	1540 with 1540-P4	Super-bright light for maximum clarity, delay triggering for optimum image positioning.
Water-jet and shuttleless looms	1544	Delay triggering for optimum image positioning, lower cost.
Spinning	1538 or 1531	Accuracy for speed or rpm measurements; fast, short flash provides clear image.
Printing and converting		High-speed printing presses and converters can be checked easily by means of a strobe. Printing registration, ink or glue uniformity, water catch up, and material stretch can all be checked without slowing or stopping the press. The strobe provides equally simple and valuable checks of other printing equipment such as folders, blankers, box- or bag-making machinery, creasing and scoring equipment, coaters or laminators, slitters-rewinders, stitchers, as well as doctoring, embossing, and perforating equipment.
Presses	1544 1540 with 1540-P4	Photoelectric and delay triggering for stable synchronization and optimum image positioning. Better choice where a large area is to be illuminated or the ambient light is very bright.
Inspection slitter-rewinders	1544	Photoelectric trigger capability and delay triggering — an excellent choice for inspection slitter-rewinders.
Machine design and maintenance		Stroboscopes can be used to observe the slippage between two shafts or between a motor and belt, to measure motor slip speed in accordance with IEEE 112A and 114, and to study the effects of cavitation on turbine blades or other hydraulic equipment. They can also be used in the design and checkout of production, handling, and packaging equipment or appliances and for studies of automobile wheel, motor, or chassis vibration.
Electro-mechanical design	1539-A with 1531-P2 1544	Photoelectric and wide-range delay triggering for optimum image positioning. An economical choice where the delay-triggering range need not be so great.
Production inspection	1531 or 1538	Accurate calibration provides speed and rpm measurements.
Plant maintenance	1531 or 1538 1542 or 1543	Best suited where accurate flash rates are necessary. More economical where accurate flash rates are unimportant.
Electrical and electronic fields		The strobe is a valuable aid in the development of loudspeakers and other audio devices and in the design, production and servicing of electric motors, card sorters or punches, and automatic component-handling equipment. Also valuable for monitoring the action of environmental shake tables and to study switch or relay bounce.
Electrical inspection	1531 or 1538	Provide accurate speed, time, or rpm measurements.
Photography and TV		Effective shutter speeds some 1000 times faster than mechanical shutters are possible by use of a strobe. Permits detailed examinations of such single-action events as the impact of a bullet, an explosion, glass fracture, destructive tests, and other extremely high-speed phenomena.
Single or multiflash	1540 with 1540-P4 1539-A with 1531-P2	Super-bright light, precise camera synchronization. Provides excellent single-flash photos at an economical price. The 1541 Multiflash Generator is an excellent accessory for any high-speed photo work and can be used with any GR strobe to produce flash rates as high as 100,000 per second.

GR Strobe Characteristics

	Internal Oscillator		External Triggering				Flash Rate*			Super-Bright Light	Battery Operation
	Accurate Time Base	Accurate Calibration	Contact	Signal	Photoelectric	Delayed	(max flashes per minute)				
							3800	25,000	150,000		
1540 with 1540-P1, brightest light	yes	yes	yes	yes	yes		yes	yes		yes	
1540 with 1540-P3, brightest light	no internal oscillator		yes	yes	yes		yes	yes		yes	
1540 with 1540-P4, brightest light			yes	yes	yes	100 μ s to 1 s	yes	yes		yes	
1531-AB, best general-purpose	yes	yes	yes	yes	yes with 1531-P2	100 μ s to 800 ms with 1531-P2	yes	yes			
1538-A, most versatile	yes	yes	yes	yes	yes with 1531-P2	100 μ s to 800 ms with 1531-P2	yes	yes	yes	with 1538-P4	with 1538-P3
1542-B, lowest cost							yes				
1543, low cost	line sync		yes				yes				
1544, low cost	line sync		yes	yes	yes	16 to 330 ms	yes				
1539, excellent for high-speed photography	no internal oscillator		yes	yes	yes with 1531-P2	with 1531-P2	yes	yes			

* To "stop" motion effectively, the flash rate need not be so high as the rpm of the machinery. For very high speeds, the use of strobe light at a sub-multiple flash rate (and consequently with brighter flashes) often provides the best image. This equipment is augmented by important accessories, including photoelectric pickoffs and the 1541 Multiflash Generator.

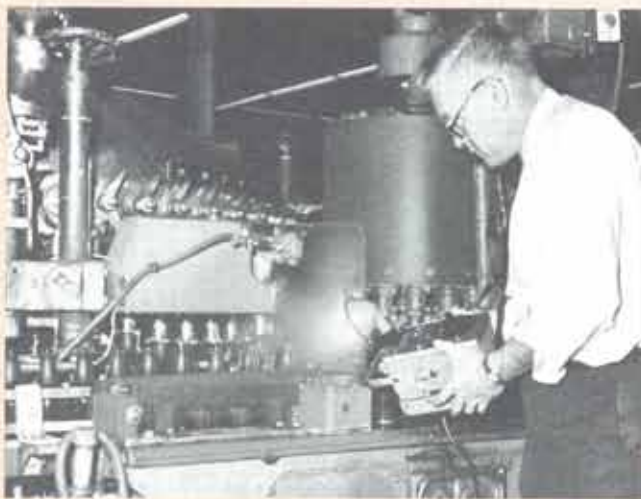

The strobe in packaging.



The strobe in the textile plant.

Internal oscillator Most GR strobes include an internal oscillator that allows the strobe to flash repetitively without need of any external signal. The frequency of the internal oscillator is adjusted by means of a knob (and a range control on some models) and thus the flash rate can be set to any desired value within its range.

Accurate time base Two of the strobes incorporate a line-sync mode, in which the internal oscillator is synchronized to the line frequency or to a submultiple (3600, 1800, 1200, 900, 720 . . . flashes per minute for 60-Hz lines). In the U.S.A., this mode provides 0.1% accuracy at these rates. Thus, the flash rate, which in the normal (free-running) mode can be adjusted continuously without accurate calibration, in the line-sync mode can be set to specific rates with a very high accuracy. The time base (known time interval) thus provided is a great convenience or even a necessity in many applications.

Accurate Calibration In some models, the flash rate is calibrated to an accuracy of $\pm 1\%$ and dial readings can be used to measure speed, rpm, or time.

In many applications, this feature is used to measure rpm so the strobe becomes an accurate and convenient tachometer. Some care must be taken in this application because the action under observation will appear stopped not only at the true rate at which the device is rotating but at whole-number submultiples of it such as $\frac{1}{2}$, $\frac{1}{3}$, $\frac{1}{4}$, etc. The truth can be simply determined as follows: True speed = $A \times B / (A - B)$, where A and B are adjacent apparent measurements (two adjacent settings of the strobe's flash rate at which the object appears stopped).

For example, assume you first obtained a reading of 2400 rpm. You then decreased the flash rate until the

object again appeared stopped and this second reading indicated 1800 rpm.

$$\text{True rpm} = \frac{2400 \times 1800}{2400 - 1800} = 7200$$

From the example, it can also be seen that the flash rate of the strobe need not be as high as the speed of the device in order to obtain accurate measurements of rpm.

Strobes that do not contain an internal oscillator require an external signal for operation. Where neither "Accurate Time Base" nor "Accurate Calibration" is indicated (shaded area), the frequency of the internal oscillator (and, hence, the flash rate) is approximate only. With that strobe, the markings on the dial (if any) cannot be used as an accurate measure of speed, rpm, or time unless they have been calibrated by the user.

External Triggering In a strobe with an internal oscillator, the motion of a device under test appears stopped when the flash rate is set to the same rate as the motion (or to some submultiple of it). If the rate of motion changes or the strobe's flash rate changes, the illusion of stopped motion disappears, and the strobe's flash rate must be readjusted for synchronization.

In many cases, the rate of motion changes often so that readjusting the strobe's flash rate to obtain synchronization becomes difficult if not impossible. Also, in many high-speed, non-repetitive events (such as explosions, rifle shots, and the like) it is necessary to flash the strobe at some precise moment determined by the event, not the strobe. In these applications, the strobe must be triggered by an external signal, rather than by its internal oscillator.

Contact The simplest method of triggering is a contact closure (or opening) such as from a switch or relay. The switch can be mounted on the device and operated by a cam, it can be a hand-held pushbutton, a camera flash-synchronization contact, or any of several dozen other switch arrangements.

Signal Another trigger source can be an electrical signal such as from an ultra-precise oscillator in order to obtain greater flash-rate accuracies, a microphone to trigger the flash from a noise such as an explosion, or another piece of electrical or electronic equipment with which synchronization is required.

Photoelectric One of the most common trigger sources is the photoelectric pickoff. These devices use light to create an electrical signal that, in turn, triggers the strobe. They are widely used because they are inexpensive, simple to install, and do not interfere with the normal operation of the device under observation. Several styles are available, including:

- A light source and a photo cell are housed in a single unit (the GR 1536-A and 1536-O). The light is aimed at the path of a piece of reflective tape attached to the device. As the tape moves past the light, the reflection back to the photo cell causes the strobe to flash.
- The light and cell are housed in two different units, mounted so that the light is aimed at the cell. The object under study moves between the light and the cell and alternately blocks the light to the cell and then allows it to pass. This arrangement is particularly useful in many printing applications where the object under study is printed on a web. The 1537-A is such a pickoff; it requires an external light source.

Delayed Without delayed triggering, the strobe flashes immediately following receipt of a trigger and, in many cases, this is exactly what is required. But in some others, this is not desirable and an adjustable time delay is in-



The strobe at the printing press.

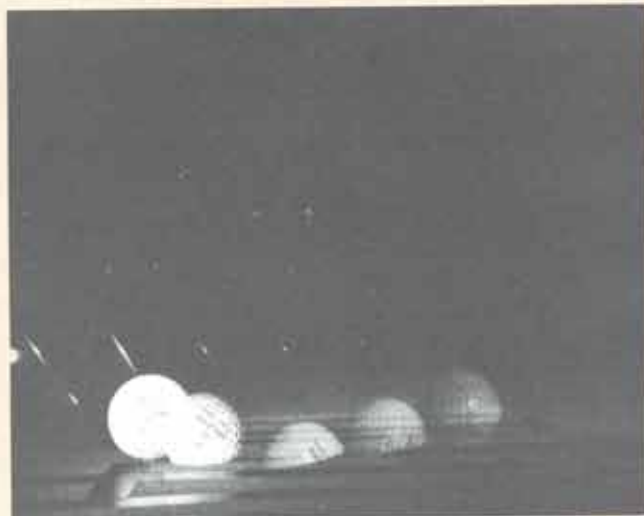

The strobe on a ballistic range.



The strobe in the air-moving industry.

corporated so the strobe flashes some time after the trigger is applied.

For example, the only convenient place to obtain a trigger on many printing presses is often somewhere remote from the point at which you wish to observe the action — the strobe may then flash at the wrong time unless great care is taken in the placement of the trigger device.

In another case, you may want to observe the action slightly after it has been initiated and yet the only time at which you can obtain a trigger is exactly at the moment the action starts. One example of this is the use of a microphone to trigger a strobe from a rifle shot — you may want to see the bullet later in flight and not at the moment it is fired.

Many machine applications require observations at several points in the operating cycle. Without a delayed trigger, several trigger devices would have to be used or a single trigger device would have to be repositioned for each observation — both solutions are costly and time consuming.

Flash rate The rate at which the strobe flashes is known as its flash rate and is usually measured in flashes per minute (fpm). For GR strobes, the flash rate is adjustable to a maximum of 3800, 25,000 or 150,000, depending on the model.

Super bright The light output from any GR strobe is bright; it has to be for clear viewing. You get the very brightest flashes from the 1540 and almost as bright from the 1538 model equipped with a 1538-P4 High-Intensity Flash Capacitor. The extra light output is very valuable in TV or photographic applications.

Battery operation Most GR strobes are small, light, and very portable. One is capable of battery operation — the 1538-A with a 1538-P3 Battery and Charger.

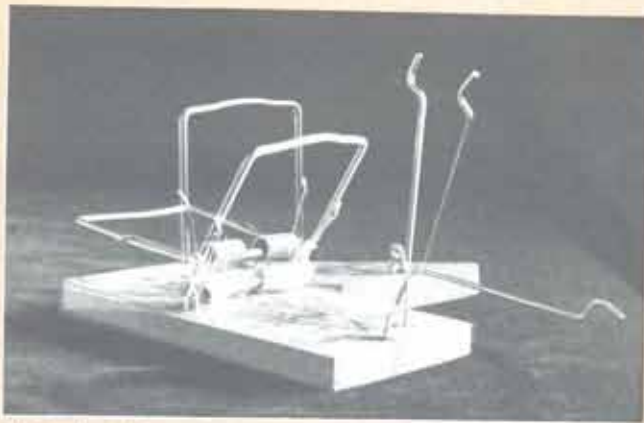

The strobe in the product-testing lab

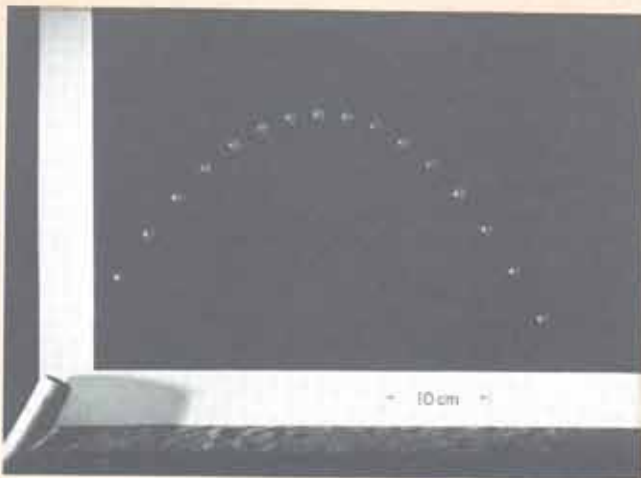

The strobe in the photo studio and classroom.

The General Radio Library

We offer not only one of the broadest lines of strobe equipment available today but also one of the broadest selections of information — all of it at your disposal and most of it free of charge:

A Primer of Stroboscopy — free. A 20-page booklet that describes the basic principles of the strobe.

Handbook of Stroboscopy — \$2.00. A 117-page authoritative work on all aspects of the strobe and its applications.

Strobotactics — free. A periodical devoted to the latest developments and applications in the strobe field.

Using Stroboscopy — free. A 16-page reprint from *Machine Design* on the principles and techniques of strobe photography.

Handbook of High-Speed Photography — \$1.00. A 92-page book that thoroughly details the strobe's role in photography.

Man's Control Over Time — A 15-minute color film on the principles of recording high-speed events. A \$15.00 handling fee is charged for the use of this film.

A Better Buy

Although GR strobes differ from unit to unit to provide you with a suitable choice, they all share one important characteristic — over 35 years of design refinement, an asset shared by no other strobe equipment. GR introduced the first commercially available strobes and has been improving them ever since. The benefits from this experience are yours no matter which GR strobe you select.

Flicker-free, reliable light from flash tubes designed for optimum performance in GR stroboscopes.

Extremely short flash durations to reduce blur and improve clarity.

Rugged construction to withstand even severe abuse or demanding environments.

Local assistance from a continually expanding network of national and international offices.

A Sure Buy

Strobes are highly dynamic tools and no measure of descriptive literature can fully describe their potential in your application. To ensure the strobe you select is the one most suited to your needs, we offer a **free trial**,

in the U.S.A. and several other countries, on all our strobe equipment. For more information, please contact your nearest Regional Center or representative.

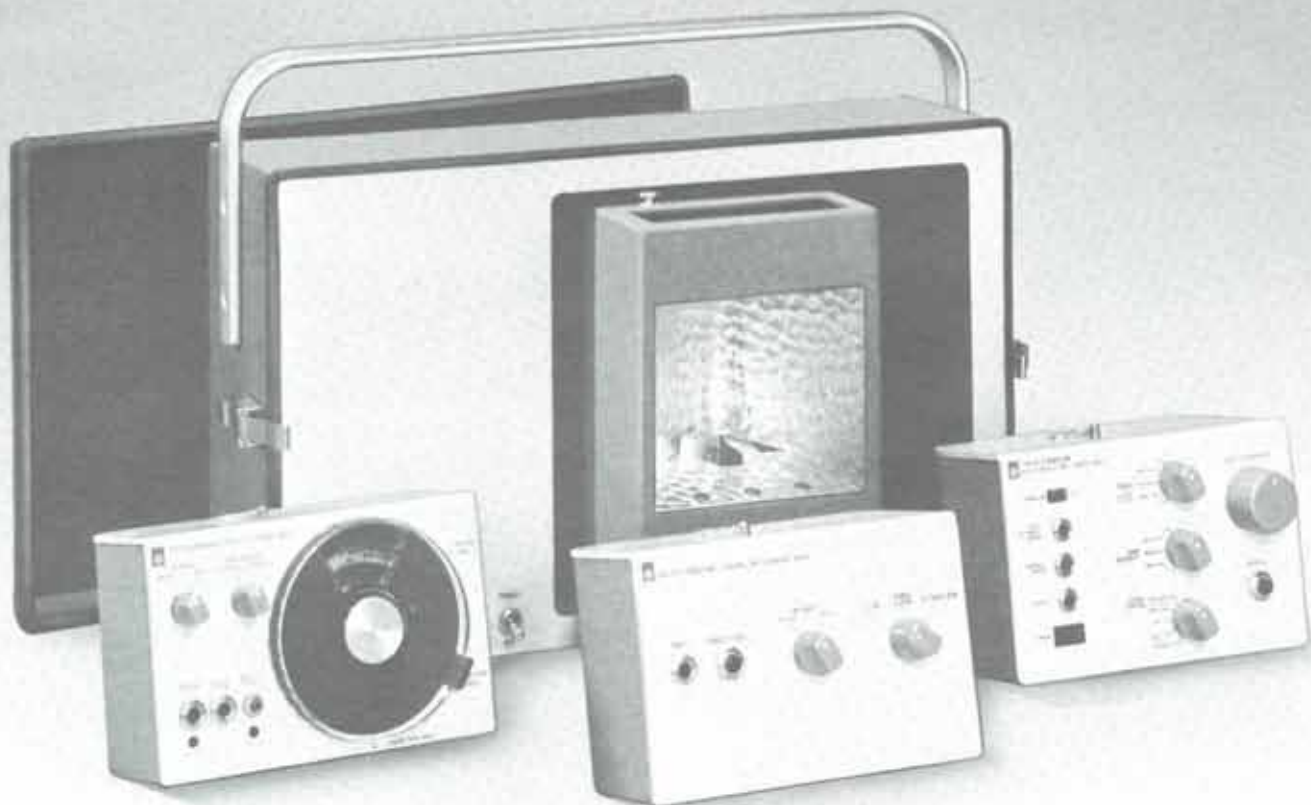

Strobolume® electronic stroboscope

Type 1540

- flash rates to 25,000 per minute
- brilliant white light
- wide-beam flood area for photography and TV

Stopped motion With the aid of a stroboscope you can examine the motion of machines, objects exploding or in flight, fluid spray patterns, and many other events as though they were motionless. With a calibrated stroboscope, you can measure the rate of repeating motion to 1% accuracy up to ¼ million rpm.

With the bright-light 1540 Strobolume® electronic stroboscope, you can perform all these tasks, and more, under difficult lighting conditions and even make color stopped-motion photographs or make videotapes. The 1540 is the first stroboscope to generate so much light and also provide the versatility for general-purpose uses. Three control units are available; with the right one for the job, the 1540 can be flashed continuously or synchronized with the motion or camera for single flashes or bursts. Thus, you can "hold" cyclic motion in one chosen position, freeze a once-only event on film or tape, or expose a motion to multiple-flash analysis.

Bright flashes Every one is a pulse of white light lasting less than 15 microseconds and illuminating a 7-by-13-foot area, 10 feet away, with brilliance enough for still or movie photography or TV recording.

The flash can be triggered from a photoelectric pickoff, the opening or closing of a switch contact or camera shutter, or an electrical pulse or sine-wave signal. The flash can occur at the instant of the triggering event or be delayed by any desired time from 100 microseconds to 1 second to catch a subsequent event.

Versatile construction The working part of the Strobolume stroboscope is the lamp head to which one of the three control units attaches, either directly or by extension cables for remote operation. The combination is small and easy to hold or mount on a tripod. A twelve-foot cable brings dc power from the larger power supply/carrying case.

To use, aim the lamp at the object to be studied (from a distance determined by the area to be illuminated and the amount of light needed). Connect the camera (any ordinary type with "X" flash synchronization) and photoelectric pickoff to the control unit and set the controls to "stop" the motion at the right point. Set the strobe for single flash, operate the shutter, and you have a picture.

—See *GR Experimenter* for Sept-Oct 1969.

SPECIFICATIONS



1540-P1 Strobolume® Oscillator

For speed measurements and general use. Provides internally generated flashing rates, accurate to 1%, for general use and is particularly well-suited for speed measurements from 110 to 25,000 rpm.

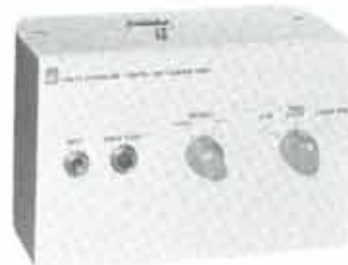

1540-P3 Strobolume® Control Unit

For use with external equipment. Provides flashes only in response to external signals. It is the lowest-priced control unit and is well suited for use with the 1541 Multiflash Generator.



1540-P4 Oscillator/Delay Unit

For motion analysis and photography. Provides internally-generated flashing rates and is the only unit that provides gated bursts of flashes as well as variable delay between receipt of a trigger and each flash. Well suited to photography; the flash can be synchronized with both motion and camera.

Flash Rate (flashes per minute):

0 to 25,000 external; single flash by means of panel pushbutton; 110 to 25,000 internal by means of calibrated control in 3 overlapping decade ranges with 1% of-reading accuracy.

0 to 25,000 external; single-flash by means of panel pushbutton.

0 to 25,000 external; single-flash by means of panel pushbutton, = 30 to 25,000 internal by means of uncalibrated control in 3 overlapping ranges. MULTIFLASH MODE permits flash bursts as long as panel pushbutton is depressed or contact closure exists at Camera jack, flash rate is set by panel controls.

Trigger:

INPUT: From 1537 Photoelectric Pickoff; contact closure; $\geq +1$ -V pulse; or ≥ 3.5 V rms sinewave at flash rate of 300, decreasing to 0.35 V at flash rates of 6000 to 25,000. OUTPUT: $\geq +6$ -V pulse behind 600 Ω .

INPUT: From 1537 Photoelectric Pickoff; contact closure; or $\geq +1$ -V pulse. OUTPUT: None.

INPUT: From 1536 (light-to-dark or dark-to-light transitions) or 1537 Photoelectric Pickoffs; contact closure or opening; $\geq +1$ -V pulse; ≥ 0.35 V rms sinewave. OUTPUT: $\geq +10$ -V pulse behind 10 k Ω .

Camera:

single flash from contact closure

single flash from contact closure

yes, see below

Delay:

none

none

yes, see below

1540-P4 Characteristics: CAMERA INPUT: Permits "X" contact closure of camera to cause flash at instant of contact closure, delayed flash synchronized to subject by external trigger signal, or multiflash "burst." DELAY: Time from external trigger to flash is continuously adjustable from ≈ 100 μ s to 1 s, uncalibrated control, 3 overlapping decade ranges. RATE of multiflash: 30 to 25,000 per min, continuously adjustable, 3 overlapping ranges.

Light Output: Measured with silicon photo detector 1 meter from lamp at maximum beam width of $\approx 40 \times 65^\circ$ (7.5x13 ft at a distance of 10 ft); can be narrowed to $\approx 17 \times 65^\circ$ (3x13 ft), intensity increases as beam narrows; beam width measured at $\frac{1}{2}$ -intensity points:

Intensity Range	Low	Medium	High
FLASH RATE, per minute	690 max	4170 max	25,000 max
FLASH DURATION*	15 μ s	12 μ s	10 μ s
ENERGY*, watt-seconds	10	1.8	0.25
BEAM INTENSITY*, candela	16x10 ⁶	4x10 ⁶	0.5x10 ⁶

* For low flash rates. Energy is electrical input to lamp.

Auxiliary input is provided for connecting a booster capacitor to increase single-flash intensity.

Remote Programming: Can be controlled by external signals, applied to rear of lamp assembly, in place of any control unit. INTENSITY: Range selection by switch closures to ground; required ratings 28 V, 60 mA. FLASH: Triggered by pulse of $\geq +0.75$ V, which must not occur while intensity range is being changed.

Environment: VIBRATION: 0.03 in. from 10 to 30 Hz. BENCH HANDLING: 4 in. or 45° (MIL STD-810-VI). SHOCK: 30 g, 11 ms.

Supplied: Power cord, 12-ft flat cable for connection of lamp head to mainframe, pouch containing adjustable neck strap for combination lamp head and control unit, phone plug for trigger input/output jacks, 6-ft cable for remote connection between lamp head and control unit.

Available: 1536 and 1537 Photoelectric Pickoffs; 1541 Multiflash Generator; extension cables for greater separation between mainframe, lamp head, and control unit.

Power: 100 to 125 and 195 to 250 V, 50 to 60 Hz, 250 W max.

Mechanical: Mainframe housed in portable cabinet and contains power supply, lamp head in associated storage compartment, and storage space for one control unit and cables. DIMENSIONS (wxhxd): Case (closed), 19x8x13.75 in. (483x203x349 mm); lamp head with control unit attached, 9.25x5.5x8.5 in. (335x140x216 mm). WEIGHT (including one control unit): 32 lb (15 kg) net, 39 lb (18 kg) shipping.

Description	Catalog Number
1540 Strobolume® electronic stroboscope mainframe. Includes 1540-P2 lamp head and power supply:	1540-9600
Select at least one of the following control units, unless the 1540 is to be remotely programmed:	
1540-P1 Strobolume® oscillator	1540-9601
1540-P3 Strobolume® control unit	1540-9603
1540-P4 Oscillator/Delay Unit	1540-9604
1540-P2 Strobolume® lamp, additional assembly	1540-9602
1540-P5 Strobotron Flash Lamp, replacement	1540-9605

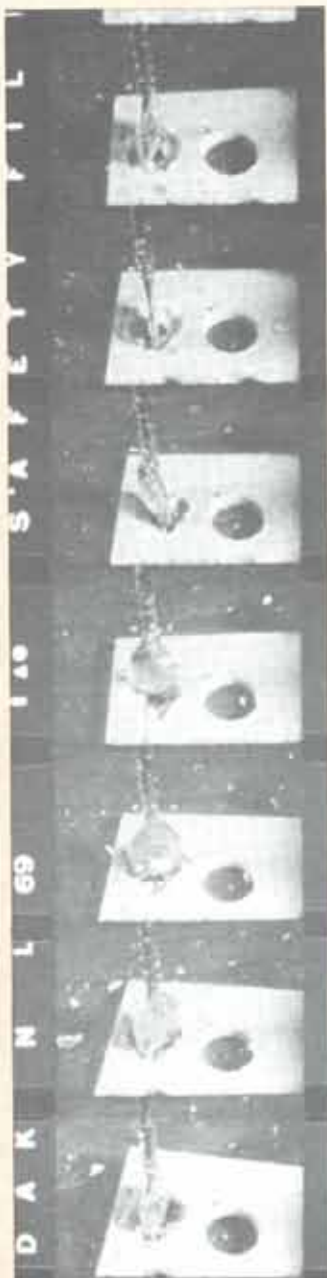

The 1540 is a valuable, economical, high-speed photographic tool. This sequence follows the action of a 2000-rpm wood bit going through a piece of particle board.



The lamp-head assembly can also be hand-held separately using the pistol-grip handle supplied.



The control unit and lamp-head assembly can be attached together and mounted on a tripod for convenience or, with the neck strap supplied, can be made as portable as your need dictates.



Its brightness and versatility make this strobe a natural for TV applications such as video recordings of rapidly-moving parts in mechanical devices.

Strobotac[®] electronic stroboscopes

Types 1531-AB and 1538-A

- speed measurements to 1 million rpm; 1% accuracy
- bright white light for high-speed photography, for observations in any normal ambient light
- simple to use, easy to handle

Compact and accurate These stroboscopes are small portable flashing-light sources used to measure the speed of fast-moving devices or to produce the optical effect of stopping or slowing high-speed motion for observation. A built-in system uses the power-line frequency for quick and easy checks and adjustment of the flash-rate calibration. Each flash-lamp/reflector assembly is hinged at the panel and the reflector swivels 360 degrees, for complete flexibility. The cases have standard sockets (0.25x20 threads/inch) for tripod mounting. The instruments are all approved by CSA Testing Laboratories.

Versatile synchronization A variety of trigger inputs can be used for flash synchronization. Contact closures, pulses, or sinewave signals will trigger the flash and an output trigger is provided so the stroboscope, in turn, can trigger another device. A 1536 Photoelectric Pickoff can be used with a 1531-P2 Flash Delay to provide an adjust-



able delay between the time a selected point on a moving object passes the pickoff and the time the strobe flashes. Single-flash photographs of high-speed motion are a snap with any still camera when the 1531-P2 is used.

The difference The 1531 is more economical to buy. On the other hand, the 1538 gives you six times the maximum flash rate of the former and also works with accessories that increase the single-flash light output (for example) by a factor of about 6, provide the convenience of an extension lamp, and enable portable operation with a rechargeable battery.

— Note: These stroboscopes are manufactured also in Europe.

SPECIFICATIONS

1531-AB: Accurately calibrated flash rates to 25,000 per minute.



1538-A: Accurately calibrated flash rates to 150,000 per minute, accessories for brighter light, extension lamp, and battery operation.



Flash Rate in flashes per minute:

110 to 25,000 in 3 ranges; speeds up to 250,000 rpm can be measured. ACCURACY: $\pm 1\%$ of reading after calibration on one range against 50-to-60 Hz line frequency.

110 to 150,000 in 4 ranges; speeds to 1,000,000 rpm can be measured. ACCURACY: $\pm 1\%$ of reading after calibration on 670-to-4170 rpm range against 50-to-60 Hz line frequency.

External Trigger, input and output connections are phone jacks:

INPUT: Contact opening, pulse $\geq +6$ V pk-pk, or sinewave ≥ 2 V rms for $f > 5$ Hz. OUTPUT: Negative pulse ≥ 500 to 1000 V.

INPUT: Contact closure, pulse $\geq +1$ V pk-pk, or sinewave ≥ 0.35 V rms for $f > 100$ Hz (3.5 V at 10 Hz). OUTPUT: $\geq +6$ V behind 400 Ω .

Light Output: Beam width 10° at 1/2-intensity points for both units:

	Duration*	Energy** watt-seconds	Beam Intensity† candela
at 690 fpm	3 μ s	0.5	11x10 ⁶
at 4170 fpm	1.2 μ s	0.09	3.5x10 ⁶
at 25,000 fpm	0.8 μ s	0.014	0.6x10 ⁶
at 150,000 fpm			

	Duration*	Energy** watt-seconds	Beam Intensity† candela
	3 μ s	0.5	15x10 ⁶
	1.2 μ s	0.09	5x10 ⁶
	0.8 μ s	0.014	1x10 ⁶
	0.5 μ s	0.0023	0.16x10 ⁶

* Measured at 1/2 peak intensity; for 1538 with -P4, duration is 8 μ s.

† Measured with silicon photo detector 1 meter from lamp; single-flash beam intensity for 1531 is = 18x10⁶ and for 1538 with -P4 it is = 44x10⁶ candela.

** Electrical input to lamp.



1538-P2



1538-P3



1538-P4

Supplied: Adjustable neck strap, phone plug for input and output jacks, power cord.

Available: 1536 and 1537 Photoelectric Pickoffs, 1531-P2 Flash Delay.

Power: 100 to 125 or 200 to 250 V, 50 to 400 Hz, 25 W max for 1531, 15 W max for 1538; 1538 can also be powered from 20 to 30 V dc, 12 W max, such as from **1538-P3** Battery and Charger that provides up to 6 h of continuous, completely portable operation and recharges in 14 h.

Mechanical: Flip-Tilt Case. DIMENSIONS (wxhxd): 10.63x6.63x13 in. (270x168x156 mm); 1538 with -P4 is 3 in. (76 mm) higher. WEIGHT: 7.5 lb (3.5 kg) net, 10 lb (4.6 kg) shipping; 1538-P4 is 5 lb (2.3 kg) net, 7 lb (3.2 kg) shipping.

Description

Catalog Number

1531-AB Strobotac® electronic stroboscope	
115-V Model	1531-9430
230-V Model	1531-9440
1538-A Strobotac® electronic stroboscope	
115-V Model	1538-9701
230-V Model	1538-9702
Accessories for 1538-A Only	
1538-P2 Extension Lamp, cannot be used when 1538-P4 is used	1538-9602
1538-P3 Battery and Charger	1538-9603
1538-P4 High Intensity Flash Capacitor, increases light output by approx 6 times	1538-9604
1531-P2 Flash Delay, for 1531 or 1538	
115-V Model	1531-9602
230-V Model	1531-9605
1538-P1 Replacement Strobotron Flash Lamp, for 1531 or 1538	1538-9601
1560-P76 Patch Cord, connects one strobe to another or to 1531-P2 Flash Delay	1560-9676
U.S. Patent Numbers 2,977,508 and 3,339,108.	

New Since
Catalog U

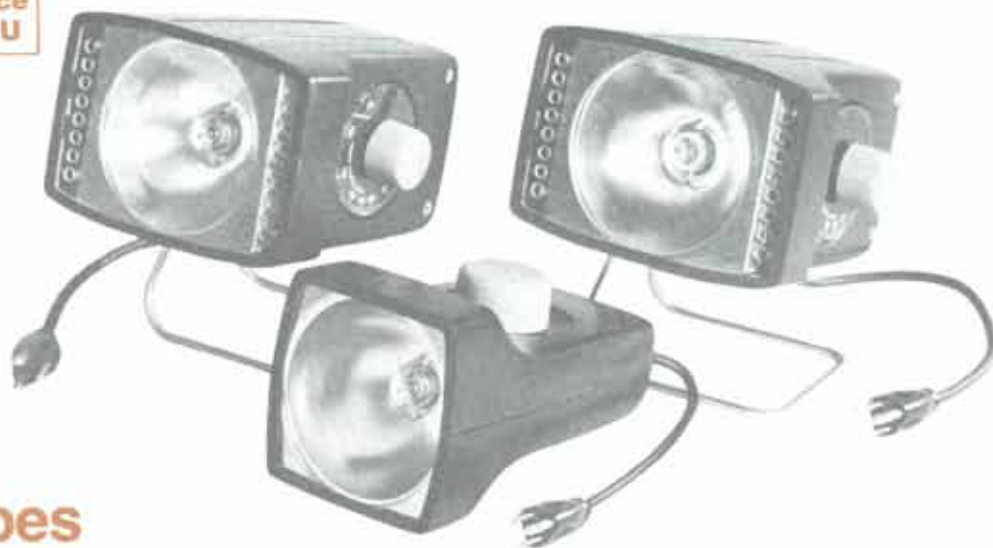

Strobotac® electronic stroboscopes

1542-B, 1543 and 1544

Feature-packed, low-cost capability

- Up to 3800 bright-white flashes per minute — to observe motion as fast as 40,000 rpm
- Wide-range continuous flash-rate control
- Low-cost, excellent OEM strobes, special versions available
- Simple pushbutton operation
- Compact, light-weight, rugged

Tailored for convenient operation These strobes were designed specifically for inspection applications and feature simple pushbutton control with a single knob to control the flash rate — no range switching is ever necessary. These strobes include unique electronically compensated output for visually constant image brightness (as the flash rate decreases, the light intensity increases). All are housed in a tough plastic case that is designed for comfortable hand-held operation and includes a threaded hole for tripod mounting.

⊕ Federal stock numbers are listed before the Index.

All components are industrial grade and the engineering is completely thorough, including exacting environmental testing to ensure reliable operation under extreme conditions.

The 1542-B — simple, economical The 1542-B is as easy to operate as an extension lamp but is considerably more useful. Plug in the attached power cord, push the On-Off button, point the light at the action, and turn one knob until the visual image of the action slows to the desired rate or stops. That's the sum total of the operation — plug, push, point, and turn!

The 1543 — triggerable In addition to the features of the 1542-B, the 1543 includes provision for external triggering and line sync. The capability of the flash to be triggered by an external contact closure is especially valuable when the motion varies or is erratic and when perfect synchronization is desired, such as with a camera for high-speed photography. A special trigger circuit automatically counts down when the input rate exceeds the normal flash rate (giving you a flash for perhaps

every second or third trigger) thereby providing for a sharp, flicker-free view. The line-sync mode allows the internal oscillator to be synchronized to a submultiple of the line frequency (3600, 1800, 1200, 900 fpm, etc). This feature is valuable for studies of line-frequency-related motion, as an accurate time base for graphic studies of acceleration and velocity, or for measurements of motor slip speed in accordance with IEEE 112A and 114.

The 1544 — delay triggerable The 1544 provides all the features of the 1543. In addition, it can be externally triggered by positive pulses and from a photoelectric pick-off, as well as contact closures, and its flash can be delayed from the moment of an external trigger by any duration from approximately 16 to 330 milliseconds. This delay feature is quite useful to vary the position of the stopped image in order to observe different phases of cyclic motion.

— Note: 220-volt versions of these strobes are manufactured in Europe.
— See **GR Experimenter** for October/December 1970.

SPECIFICATIONS

**1542-B: Simple, most economical
NEW bright light**



For education and general-purpose inspection and design applications

1543: Line sync and contact-closure trigger



For photographic, educational (especially the physics lab), and general-purpose inspection and design applications

1544: Line sync, contact-closure, photo-electric, and delayed triggers



For printing, textile, photographic, educational (mechanical engineering), mechanical design, and general-purpose inspection applications

Flash Rate	1542-B	1543	1544												
in flashes per minute (fpm):	180 to 3800, continuously adjustable over a single range by a 5-turn uncalibrated control.	180 to 3800, continuously adjustable over a single range by a 10-turn control marked in approximate flash rate. Line-sync mode provides \approx 0.1% accuracy (60-Hz line in U.S.A.) by synchronizing to integer submultiples of line frequency.	180 to 3800, continuously adjustable over a single range by a 10-turn control marked in approximate flash rate. Line-sync mode provides \approx 0.1% accuracy (60-Hz line in U.S.A.) by synchronizing to integer submultiples of line frequency.												
External Trigger:	None	Contact closure (isolated from ground) applied to phone jack.	Contact closure, positive signal $>$ 2 V peak, or GR 1536 Photoelectric Pickoff.												
Trigger Delay:	None	None	\approx 16 to 330 ms from application of external trigger; set by flash-rate control.												
Light Output, Beam width 10° at 1/2-intensity points for all units:	<table border="1"> <thead> <tr> <th></th> <th>Duration*</th> <th>Energy**</th> <th>Beam Intensity†</th> </tr> </thead> <tbody> <tr> <td>at 180 fpm:</td> <td>4 μs</td> <td>0.25 Ws</td> <td>6 \times 10⁶ cd</td> </tr> <tr> <td>at 3800 fpm:</td> <td>3 μs</td> <td>0.05 Ws</td> <td>1 \times 10⁶ cd</td> </tr> </tbody> </table>				Duration*	Energy**	Beam Intensity†	at 180 fpm:	4 μ s	0.25 Ws	6 \times 10 ⁶ cd	at 3800 fpm:	3 μ s	0.05 Ws	1 \times 10 ⁶ cd
	Duration*	Energy**	Beam Intensity†												
at 180 fpm:	4 μ s	0.25 Ws	6 \times 10 ⁶ cd												
at 3800 fpm:	3 μ s	0.05 Ws	1 \times 10 ⁶ cd												
	<table border="1"> <thead> <tr> <th></th> <th>Duration*</th> <th>Energy**</th> <th>Beam Intensity†</th> </tr> </thead> <tbody> <tr> <td>at 180 fpm:</td> <td>4 μs</td> <td>0.75 Ws</td> <td>30 \times 10⁶ cd</td> </tr> <tr> <td>at 3800 fpm:</td> <td>6 μs</td> <td>0.2 Ws</td> <td>4 \times 10⁶ cd</td> </tr> </tbody> </table>				Duration*	Energy**	Beam Intensity†	at 180 fpm:	4 μ s	0.75 Ws	30 \times 10 ⁶ cd	at 3800 fpm:	6 μ s	0.2 Ws	4 \times 10 ⁶ cd
	Duration*	Energy**	Beam Intensity†												
at 180 fpm:	4 μ s	0.75 Ws	30 \times 10 ⁶ cd												
at 3800 fpm:	6 μ s	0.2 Ws	4 \times 10 ⁶ cd												

* Measured at 1/2 of peak-intensity points.

** Electrical input to lamp, watt-seconds.

† Measured with silicon photo detector 1 meter from lamp, candela.

Environment: TEMPERATURE: 0 to 50°C operating, -40 to +75°C storage. HUMIDITY: 95% RH at +40°C (MIL E-16400-4.5.4.6). VIBRATION: 0.03 in. from 10 to 55 Hz. BENCH HANDLING: 4 in. or 45° (MIL-810A-VI). SHOCK: 50 g, 11 ms (MIL 202C-205C).

Power: 105 to 125 V, 50 to 60 Hz, 9 W max for 1542-B, 25 W max for 1543 and 1544.

Mechanical: Molded plastic case with plastic face plate to protect lamp, diffused-finish anodized-aluminum reflector, standard 0.25-20 threaded hole for tripod mounting. 1543 and 1544 also include metal stand/handle. **1542-B DIMENSIONS**

(wxhxd): 4.2x4.2x7.8 in. (107x107x198 mm). WEIGHT: 1.8 lb (0.8 kg) net, 2 lb (0.9 kg) shipping. **1543 and 1544 DIMENSIONS** (wxhxd): 4.2x6.19x7.8 in. (107x157x198 mm). WEIGHT: 3.7 lb (1.7 kg) net, 5 lb (2.3 kg) shipping.

Description	Catalog Number
1542-B Strobotac® electronic stroboscope	1542-9701
1543 Strobotac® electronic stroboscope	1543-9700
1544 Strobotac® electronic stroboscope	1544-9700
Replacement Flash Lamp: For 1542-B, 1543, and 1544	1530-9410



Stroboslave® stroboscopic light source

Type 1539

- low cost, compact
- removable lamp on 5-foot cable
- high-intensity light
- choice of trigger sources

Slaved light The Stroboslave® stroboscopic light source satisfies the basic requirements for motion studies and high-speed photography — it produces a bright white light at flash rates up to 25,000 per minute. Since it contains no internal oscillator to establish the flash rate, it is an economical unit and is well suited for use with external inputs such as from the 1541 Multiflash Generator.

The lamp and reflector assembly is held in place by a clip from which it can be easily removed and positioned separately from the main unit. A five-foot flexible cable is supplied and cables up to 50 feet can be used. When



A tripod socket is provided on the Stroboslave® case.

The lamp can be removed from its clamp at end of case and hand-held up to 5 feet away.



the reflector is removed from the assembly, the lamp can be inserted through holes as small as one inch in diameter, thus making it possible to observe objects in otherwise inaccessible areas.

Delayed light — the 1539-Z The Stroboslave strobe can be triggered by a contact closure or a two-volt positive pulse. This capability has proved so useful when used with the 1531-P2 Flash Delay and 1536 Photoelectric Pickoff that the Stroboslave is regularly available with these two accessories as the 1539-Z Motion-Analysis and Photography Set. The Flash Delay provides adjustable delays from 100 μ s to 800 ms from the time of the trigger to the time of the flash, so you can make the flash occur at precisely the desired moment.

SPECIFICATIONS

Flash Rate: 0 to 25,000 flashes per minute, eternally triggered only.

Light Output: Beam width is 10° at ½-intensity points.

	Duration*	Energy**	Beam Intensity†
at 700 fpm	3 μ s	0.5 Ws	11 × 10 ⁶ cd
at 4200 fpm	1.2 μ s	0.09 Ws	3.5 × 10 ⁶ cd
at 25,000 fpm	0.8 μ s	0.014 Ws	0.6 × 10 ⁶ cd

* Measured at ½ of peak-intensity points.

** Electrical input to lamp, watt-seconds.

† Measured with silicon photo detector 1 meter from lamp; single-flash beam intensity is 18 × 10⁶ candela.

External Trigger: Contact closure or pulse of $\geq +2$ V pk applied to phone jack.

Supplied: Phone plug for input jack, mounting bracket, attached power cord.

Available: 1536 Photoelectric Pickoff with 1531-P2 Flash Delay (available as 1539-Z Motion Analysis and Photography Set), 1537 Photoelectric Pickoff.

Power: 100 to 125 or 195 to 250 V, 50 to 400 Hz, 16 W max.

Mechanical: Metal case with detachable lamp housing. DIMENSIONS (wxhxd): 1539-A, 2.5x8.38x4.13 in. (64x213x105 mm). WEIGHT: 1539-A, 3 lb (1.4 kg) net, 8 lb (3.7 kg) shipping; 1539-Z, 6 lb (2.8 kg) net, 17 lb (8 kg) shipping.

Description	Catalog Number
1539-A Stroboslave® stroboscopic light source	1539-9701
1539-Z Motion Analysis and Photography Set	
115-V Model	1539-9900
230-V Model	1539-9901
1531-P4 Trigger Cable, for use with 1531 Strobotac	1531-9604
1538-P1 Strobotron Flash Lamp, replacement	1538-9601
U.S. Patent Number 2,977,508.	

* Federal stock numbers are listed before the Index.

**New Since
Catalog U**

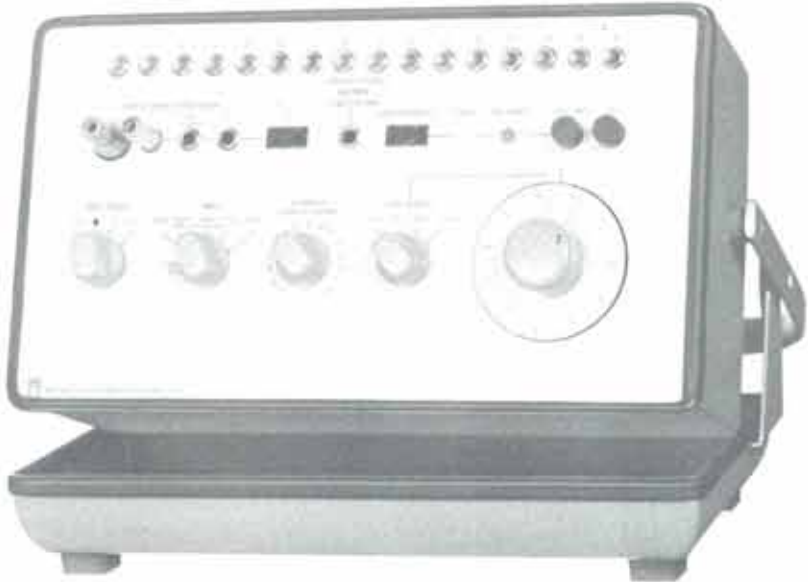

1541 Multiflash Generator

- a true flash-burst trigger generator
- increases effective flash rates of strobes to 100,000 per second
- accurately-calibrated flash delay and time-interval source
- synchronizes strobes for still, cine, and high-speed movie applications.

A new dimension The 1541 is a simply operated accessory that greatly expands the resolution, accuracy, and versatility of many kinds of strobes for high-speed still- or cine-camera photographic applications. A great variety of shots, from single exposures to cine-graphic sequences with several exposures per frame, can be

made with ease; a wide-range delay control enables the image to be set exactly to the required position.

Complete synchronization with the camera and the device under observation is ensured under nearly any circumstances. A highly flexible output arrangement permits a wide latitude in the type and the number of strobes used, their positions, and the timing of their flashes.

For single-strobe use The input trigger from the subject can be a contact opening or closure, a light-to-dark or a dark-to-light transition sensed by a photocell, or a ± 1 -volt electrical pulse. The flash can be delayed by any period from 10 millionths of a second to a tenth of a second after the instant of the trigger, so that it occurs exactly when you need it in relation to the motion.

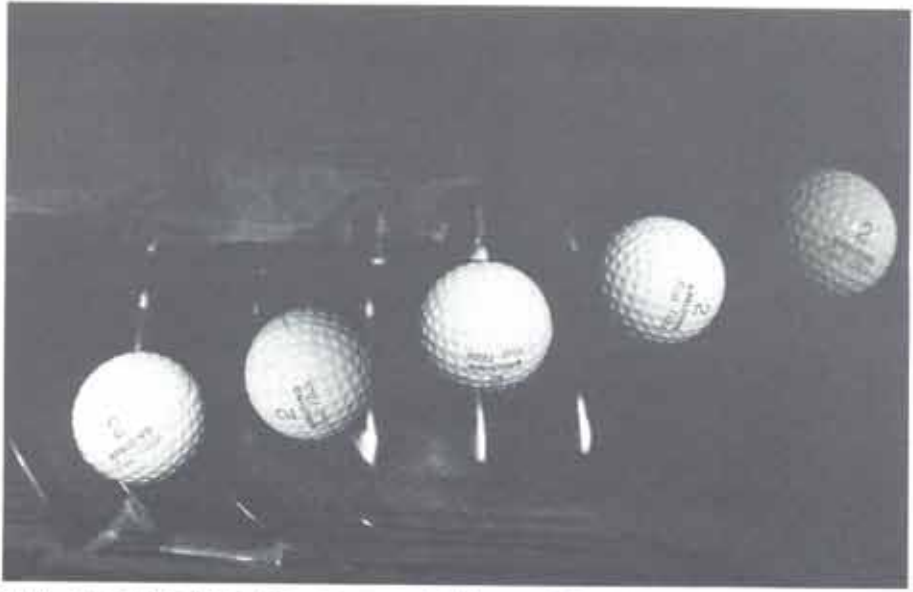
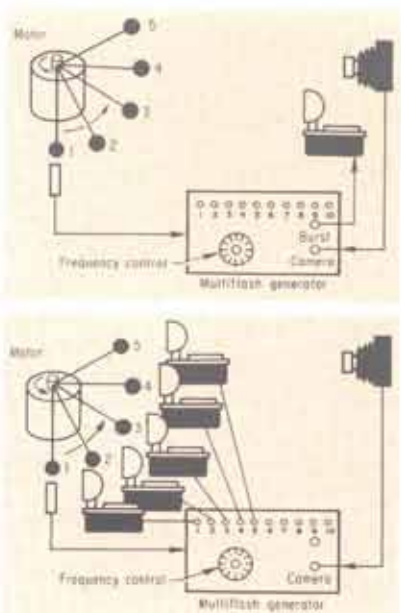

Single- and multiple-strobe setup and one application — golfball-driving analysis.

An arming input from the camera can be used so that each flash occurs only when both the camera shutter is open and the subject is in the desired position. In addition to a single flash from the strobe, a flash burst of any number of flashes up to 16 can be initiated from the application of each trigger. The interval between flashes is the same as the time delay and is accurate to within 3% for precise measurements of speed, acceleration, and event timing.

For multi-strobe use The 1541 will trigger as many as 16 strobes in sequence, each flash being accurately delayed from its predecessor. Such an arrangement can provide you with exceptionally high flash rates, the highest possible intensity per flash, and real flexibility in subject illumination.

For example, when 16 strobes are used in rapid sequence, the effective flash rate for a short interval can be as high as 100,000 flashes per minute, each flash being at the full single-flash intensity.

Another value in having several strobes flashing in sequence is that they can be positioned along the path of a moving object, each strobe where it can best illuminate the object at an assigned moment. The path may be far too long for illumination by a single strobe. Also, filters of different colors can be used with the several strobes, enabling you to identify each portion of a colored multi-flash photograph with a high degree of confidence.

— See *GR Experimenter* for July-September 1970.

SPECIFICATIONS

Modes: CONTINUOUS: Internal oscillator continuously runs either single or multiple strobes at a rate set by panel controls; provision made to extend low-frequency range by means of external capacitor. **CALIBRATE:** Continuous calibration signal of +20 V behind 60 Ω available at rear phone jack for use

with electronic counter. **BURST ON INPUT:** Each input trigger initiates a flash burst. **BURST ON ARM AND INPUT:** Only one flash burst is produced by a trigger signal following an input arming signal; input is armed by panel pushbutton or external contact closure, such as a switch or shutter contact; panel lamp indicates armed or unarmed condition. **MOVIE:** One sequenced output pulse is produced for each input pulse; the number of pulses in the sequence can be 2 to 16 as determined by panel control.

Input Trigger for subject or event sync: Contact opening, contact closure, ± 1 -V pulse, or light-to-dark or dark-to-light transition from 1536 Photoelectric Pickoff.

Output Trigger: +20 V behind 60 Ω . TO SINGLE STROBE: 1 to 16 equally spaced pulses, switch selectable. TO SEPARATE STROBES: 2 to 16 equally spaced pulses; set number by panel control.

Flash Interval: RANGE: 100 ms to 10 μ s (10 to 100,000 flashes per second) in 4 overlapping decade ranges; provision for addition of external capacitor to extend low-frequency range. **ACCURACY:** $\pm 3\%$ of reading + 1 μ s.

Environment: TEMPERATURE: 0 to +50°C operating, -40 to +75°C non-operating. HUMIDITY: 95% RH and +40°C. VIBRATION: 0.03 in. from 10 to 55 Hz. BENCH HANDLING: 4 in. or 45° (MIL STD-810A-VI). SHOCK: 30, 11 ms.

Supplied: 1541-9601 6-ft cable with phone plugs for connection of output to strobe, 1531-0421 trigger cable with remote arming switch, power cord.

Available: 1531, 1538, 1539, 1540 stroboscopes, 1536 Photoelectric Pickoff with built-in light source, 1192 counter.

Power: 100 to 125 and 200 to 250 V, 50 to 400 Hz, 10 W max.

Mechanical: Flip-Tilt case. DIMENSIONS (wxhxd): 14x10x6.69 in. (356x254x170 mm). WEIGHT: 11 lb (5 kg) net, 15 lb (7 kg) shipping.

Description	Catalog Number
1541 Multiflash Generator	1541-9701
Cable assemblies to connect strobes to output:	
3 ft with phone plugs	1560-9676
6 ft with phone plugs	1541-9601

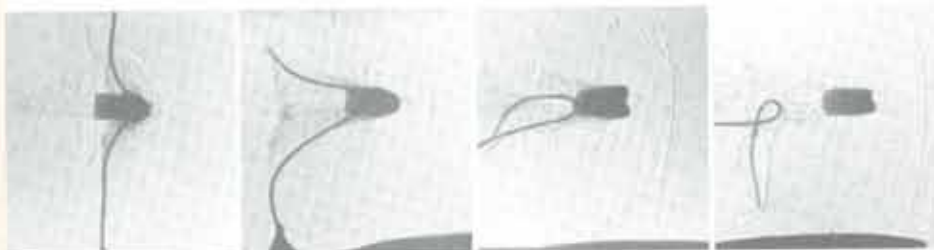
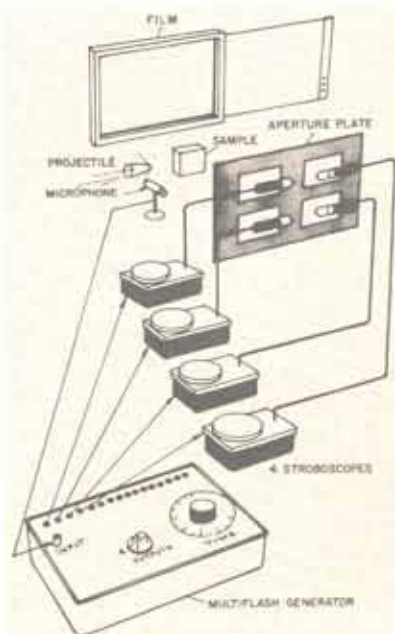

Strobe shadowgraph shows a .22 caliber bullet striking and being cut in two by a steel wire — the supersonic whip of the wire end is clearly visible. Separation of the four images is achieved by flashing the strobes at intervals of 40 microseconds.

Strobe Accessories

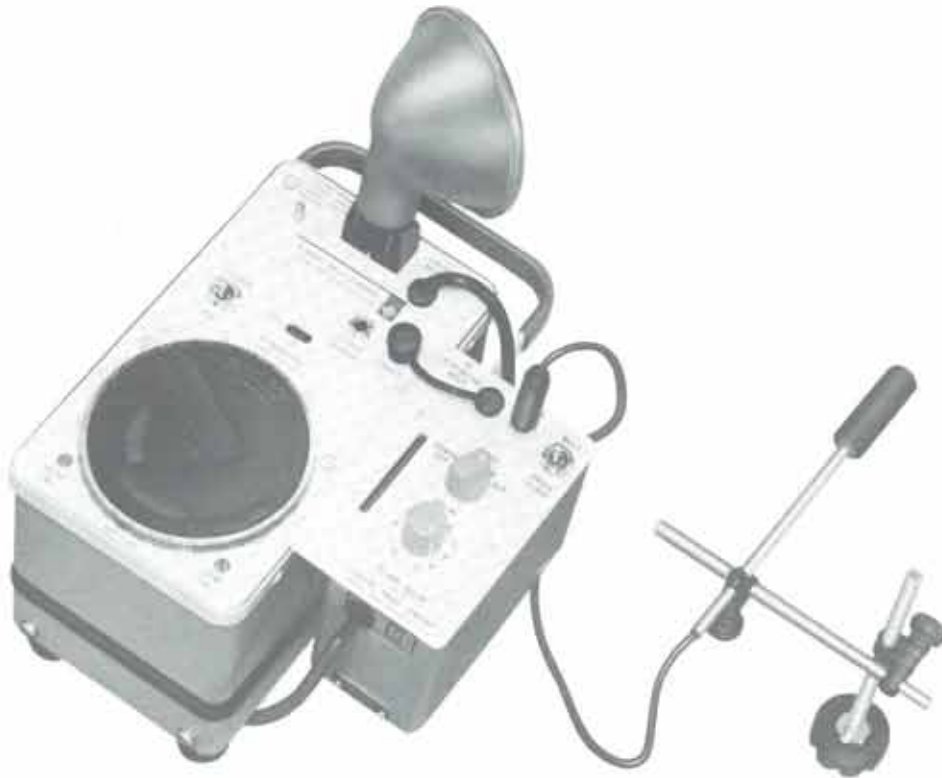

Strobotac shown with Flash Delay and Photoelectric Pickoff.

1531-P2 Flash Delay

- synchronizes and times flash
- stops motion at any point in cycle
- is easily synchronized with camera for single-flash operation
- easily attached to 1531-AB, 1538-A, and 1539-A

Valuable asset The 1531-P2 is a valuable asset to any stroboscopic or high-speed photographic application. The Flash Delay synchronizes the strobe with rapidly moving objects and controls the flash, relative to the position of the object, by introducing a variable time delay in the electrical path between the trigger source (transducer, contact, photocell, etc) and the strobe. In stroboscopic applications this delay allows you to position the stopped motion to any point of interest in the action. By the simple turn of a knob, you can reposition the image to illustrate a dozen, or even a hundred, points in order to analyze completely all aspects of the motion.

For photographic records, a single-flash mode is provided. Once the delay has been set so the image is posi-

tioned properly, the mode is set to Single Flash and the flash will then occur only when the camera shutter is released *and* the action is in the proper position. This mode allows the brightest possible flash and eliminates blur.

SPECIFICATIONS

Delay: 100 μ s to 800 ms in 3 ranges.

Input: 300 mV rms min applied to phone jack.

Output: +13-V pk pulse, sufficient to trigger 1531, 1538, 1539, 1540, and 1541; available at phone plug.

Supplied: Trigger cable with pushbutton, phone-plug adaptor, carrying case.

Power: 105 to 125 or 210 to 250 V, 50 to 400 Hz, 5 W max with 1536 connected.

Mechanical: Aluminum case with bracket that clips directly to 1531, 1538, or 1539 stroboscope. DIMENSIONS (wxhxd): 5.13x3.13x3.75 in. (130x79x95 mm). WEIGHT: 2 lb (1 kg) net, 5 lb (2.3 kg) shipping.

Description	Catalog Number
1531-P2 Flash Delay	
115-V Model	1531-9602
230-V Model	1531-9605

1531-P3 Surface-Speed Wheel

Surface-speed measurements simplified The 1531-P3 is used with the 1531, 1538, and 1540 (with 1540-P1 control unit) electronic stroboscopes to make accurate measurements of the linear surface speed of belts, pulleys, wheels, drums, rollers, etc. Two black nylon wheels of different diameters are mounted on the ends of a sectioned steel rod. The selected wheel is held against the moving object and the stroboscope is adjusted until the wheel's rotation appears stopped. The wheel's diameters are sized so the surface speed can be read directly from the stroboscope dial.



SPECIFICATIONS

Speed: 10 to 2500 ft/min with small wheel; 50 to 12,500 ft/min with large wheel.

Mechanical: DIMENSIONS: Wheels, 0.764 and 1.910 in. dia; shaft, 20 in. (533 mm) total length. WEIGHT: 0.5 lb (0.3 kg) net, 2 lb (1 kg) shipping.

Description	Catalog Number
1531-P3 Surface-Speed Wheel	1531-9603



1536-A, 1537-A



1536-O

New

1536 and 1537 Photoelectric Pickoffs

- optical trigger sources
- small, sturdy mounting
- trigger rates to 150,000 rpm

Excellent trigger source These photoelectric pickoffs produce an output whenever the photosensitive element senses a change in light such as that produced by a piece of reflective type on a moving object. The resultant pulses can be used to trigger a stroboscope so the flashes occur in synchronism with the motion, to permit the object to be viewed or photographed as though stationary. They can also be used to trigger oscilloscopes or electronic counters.

The 1536-A Pickoff, in addition to its photocell, contains a light source that can be powered directly from the 1531-P2 Flash Delay, 1540-P4 Oscillator/Delay, 1541 Multiflash Generator, or 1544 Strobotac® electronic stroboscope. This pickoff's 8-ft cable is terminated with a 3-wire telephone plug.

The 1536-O pickoff is electronically identical to the 1536-A and can be used with the same equipment. They differ only in mechanical details. The 1536-O is designed to be permanently attached to a machine such as a printing press, processing equipment, etc. It is contained in a 0.75-in.-27 threaded housing with an attached 15-foot cable terminated with a 3-wire telephone plug.

The 1537-A pickoff will trigger the 1538, 1539, 1540-P1, 1540-P3, 1540-P4, or 1541 but not the 1531 stroboscopes.

Since it lacks a built-in lamp, this pickoff must be used with an external light source. The 1537-A pickoff's 8-ft cable is terminated with a 2-wire telephone plug.

SPECIFICATIONS

	1536-A, 1536-O, with lamp	1537-A, no lamp
Rate	~2500 pulses/s max; limited by 200- μ s time constant of cable and photocell.	>2500 pulses/s
Power	20 to 28 V dc, 40 mA; supplied by 1531-P2, 1540-P4, 1541, 1544.	3 to 25 V dc, 0 to 100 μ A depending on rate

Supplied: 10-ft roll of 0.38-in black tape, 10-ft roll of 0.38-in silver tape, carrying case (supplied with 1536-A and 1537-A only).

Mechanical: 1536-A and 1537-A: Mounted by C clamp (1.31-in. capacity, flat or round) or 1.5-in. magnet; both supplied. DIMENSIONS: Pickoff head, 0.69-in. dia x 2-in. long. Linkage consists of two 0.31-in. dia stainless-steel rods, 6 and 6.25 in. long, and adjustable connecting clamp. Cable is 8 ft (2.4 m) long, terminated in 3-wire phone plug in 1536-A, a 2-wire phone plug in 1537-A. WEIGHT: 1.3 lb (0.6 kg) net, 4 lb (1.9 kg) shipping. **1536-O:** Mounted by 0.75-in.-27 nut. DIMENSIONS: 0.75-in. dia x 2.063 in. long (19 x 52 mm). Cable is 15 ft (4.6 m) long, terminated in 3-wire phone plug. WEIGHT: 0.4 lb (0.2 kg) net, 2 lb (1 kg) shipping.

Description	Catalog Number
1536-A Photoelectric Pickoff, with lamp	1536-9701
1536-O Photoelectric Pickoff, with lamp	1536-9702
1537-A Photoelectric Pickoff, no lamp	1537-9701

Line-Voltage Regulators

GR Variac® automatic line-voltage regulator	Output Current <i>at nominal input voltage of</i>			Input Frequency (Hz)		
	115 or 120 V	230 or 240 V	460 V	50	60	400
1591 (portable)	8.7 A				●	
1592	to 44 A	to 42 A		●	●	
1571 (militarized)	to 50 A			●	●	
1581	to 50 A	to 40 A		●	●	●
1582	to 85 A	to 85 A	to 34 A	●	●	●

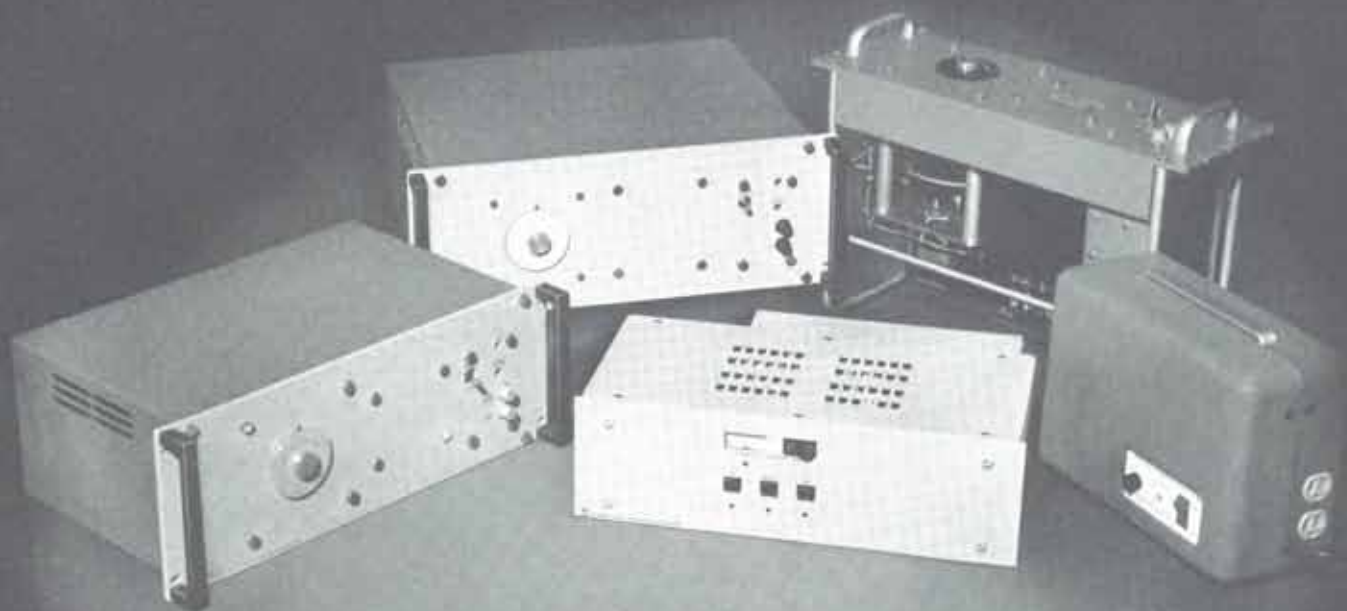

Variac® automatic voltage regulators

The answer to line-voltage problems If your problem is poor process control, computer errors, inaccurate instrumentation, overheated motors, cool heaters, or other assorted equipment aberrations, an excellent solution is a General Radio Variac® automatic line-voltage regulator.

GR regulators have many advantages for both laboratory and industrial use in any application where controlled line voltage is needed, and they are particularly valuable to offset the effects of brownouts.

There are 5 basic models of GR regulators and over 100 variations, plus units built to your specifications. All offer outstanding performance characteristics:

- Regulation to 0.2%
- Insensitive to load type, they work equally well on all loads from open circuit to maximum rating
- Up to 10 times rating for transient surges
- Introduces no distortion or noise
- No power-factor restrictions
- Fast response, comparable with magnetic types
- Reliable solid-state controls

Simple, smooth operation The regulator comprises a motor-driven Variac® adjustable autotransformer, an auxiliary step-down transformer that multiplies the power rating of the autotransformer in the larger models, and a solid-state control unit that automatically positions the autotransformer to hold the output voltage constant.

The regulator's output voltage is compared to a reference voltage and the resultant error signal controls a servo motor to provide a true proportional-control system, rather than an on-off circuit. The accompanying oscillograms illustrate a typical response to a 2% step change in line voltage. The traces are greatly expanded and show only the ac voltage peaks.

The use of a true proportional-control system provides not only fast correction but also smooth control of voltage, completely free of the voltage jumps introduced by an on-off control system. The absence of relays provides long trouble-free life, and tolerance of 1000% transient overloads is made possible by the Duratrak® commutator surface of the Variac autotransformer.

The regulators maintain an undistorted output that is corrected to the limits of the correction range; i.e., if the input to a 10% regulator varies 15%, the output will vary only 5%.

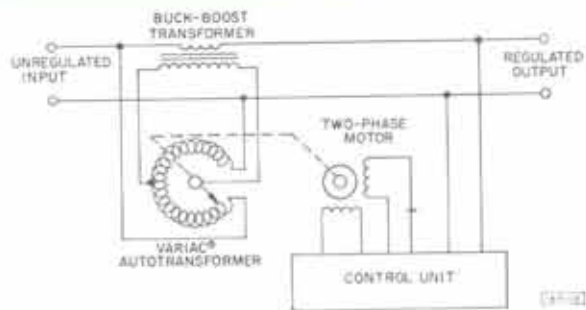

Elementary schematic diagram of General Radio voltage regulators.

Single-phase selection The proper regulator for your application depends on your input-line characteristics and the output characteristics desired from the regulator. GR regulators cover the following conditions:

INPUT Frequency: 50, 60, or 400 Hz.

Nominal Voltage: 115 or 120 (also 230 and 460) V.

Range of inputs, with regulation: 72 to 156 V.

OUTPUT Voltage: 90 to 130 V, adjustable

Current: 8.7- to 85-A ratings

The input range for most GR regulators is expressed as a percentage of the output voltage (± 5 , ± 10 , ± 20 , or $+24 - 18\%$). For example, if the output is set to 100 V on a regulator with a $\pm 10\%$ range, the input can vary from 90 to 110 V and the regulator will maintain a constant 100-V output. Under some conditions for three-phase systems, this range can be appreciably increased; see below, under Three-Phase Selection, three-wire inputs.

Output-current rating is a function of the input range — the greater the range, the less the current capability. (For a given voltage model, the input range can easily

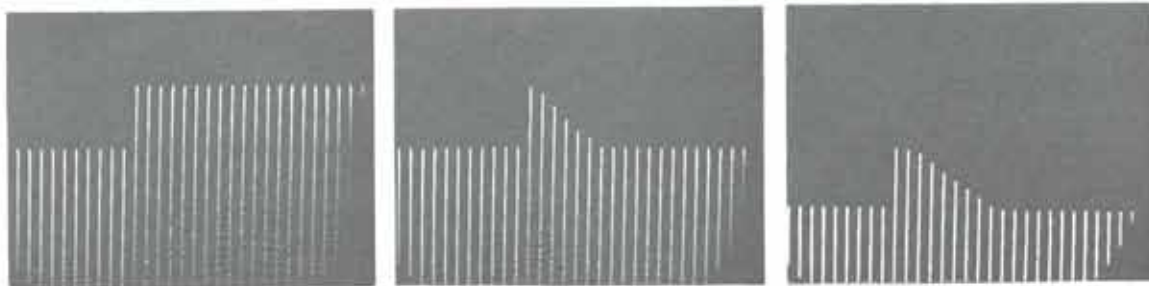

Oscillograms of line-voltage peaks show response speed of Variac® automatic voltage regulators: left, 2% step change in line voltage; center and right, resulting output transients for 1581 and 1582 Regulators, respectively.

be changed in the field.) Thus a GR 1592 regulator rated at 44 amperes for a $\pm 10\%$ range is rated at 20 amperes for a $\pm 20\%$ range. Detailed information is included with the descriptions of each GR regulator to allow you to select the best regulator for your application. Additional information or advice is readily available from any GR sales office whenever you may need it. The Regulation Ranges graph and examples on these pages are intended to allow you to select the basic type of GR regulator you may need and to acquaint you with some of the techniques involved in getting the most for your money.

Example 1 Your input is nominally 115 or 120 V, 60 Hz, and your load requires up to 5 A. For this, any basic GR regulator is satisfactory. You specifically desire a 115-V output and you've determined your line voltage varies from 95 to 130 V. This restricts your choice slightly, since the GR 1591 will not regulate with an input below 100 V.

Example 2 Suppose your requirements are similar to example 1 except you've discovered the input may go as low as 90 V. Under these circumstances, no GR regulator appears suitable. However, since your 115-V output requirement is not critical (many devices operate properly over a range of voltages, such as from 105 to 125 V), you decide an output of 110 V is adequate. It is now apparent that any GR regulator, except the 1591, is again suitable.

Example 3 In this case the initial conditions are the same as example 2 except that the output voltage must be exactly 100 V. The 1592 is the only regulator that will provide this output; and the input range is 80 to 120 V.

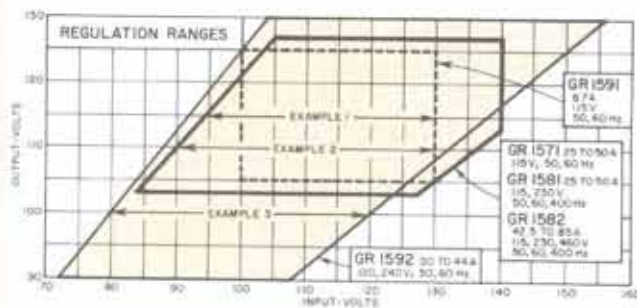

Information is shown for 115- and 120-V, 60-Hz models. For 230-V models, multiply voltages and divide current ratings by 2 (for 460-V models, by 4). The regulation range is slightly less for 400-Hz models but is significantly greater in some three-phase applications. (See Three-Phase Selection, three-wire inputs.) More detailed information, particularly current ratings, is given with the descriptions of the individual regulators.

Three-phase selection All GR regulators can be used in three-phase systems. The choice of the regulator used and the number required depend on the number of input lines (three- or four-wire) and the configuration used to connect the regulators.

For three-wire inputs, the regulators can be connected in either an open-delta or a closed-delta configuration. In open delta, only two regulators are required and their input range is the same as that for single-phase systems. In closed delta, three regulators are required but their input range is increased by slightly over 50%. For four-wire inputs, three regulators are connected in a wye configuration and their input voltage requirements are reduced to about 58% of that normally required.

The individual regulators are selected on the same basis as those used for single-phase systems, once the nominal voltage has been determined.

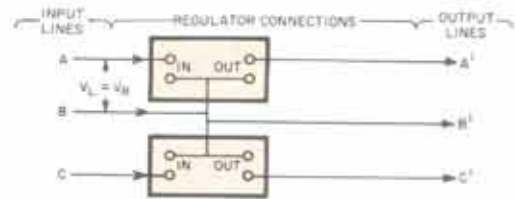

OPEN DELTA The input voltage to each regulator (V_R , A to B or B to C) is equal to the line-to-line voltage (V_L), i.e., $V_R = V_L$.

V_L Line-to-Line	V_R Input to Regulator	Basic Regulator Required
208 V	208 V	230-V nominal voltage
230 to 240 V	230 to 240 V	230-V nominal voltage
460 to 480 V	460 to 480 V	460-V nominal voltage

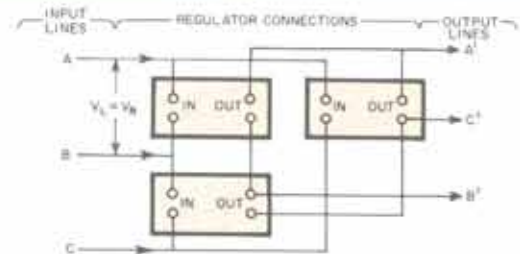

CLOSED DELTA The input voltage to each regulator (V_R , A to B, B to C, or C to A) is equal to the line-to-line voltage (V_L); i.e., $V_R = V_L$. The input range increases by slightly over 50%. Thus, the input range increases to ± 7.5 , ± 15 , ± 31 , and $+37 - 28\%$ from the normal ± 5 , ± 10 , ± 20 , and $+24 - 18\%$, respectively.

V_L Line-to-Line	V_R Input to Regulator	Basic Regulator Required
208 V	208 V	230-V nominal voltage
230 to 240 V	230 to 240 V	230-V nominal voltage
460 to 480 V	460 to 480 V	460-V nominal voltage

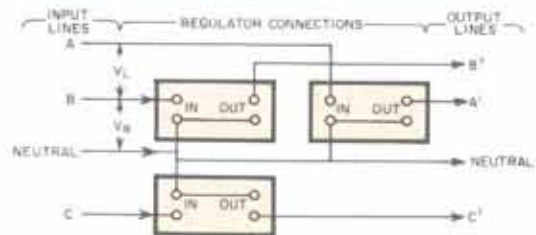

WYE The input voltage to each regulator (V_R , A, B, or C to neutral) is equal to the line-to-line voltage (V_L , A to B, B to C, or C to A) divided by 1.73. This reduces the input voltage requirements to about 58% of that normally required.

V_L Line-to-Line	V_R Input to Regulator	Basic Regulator Required
208 V	120 V	115 or 120-V nominal voltage
230 to 240 V	133 V	115 or 120-V nominal voltage
460 to 480 V	266 V	230 or 240-V nominal voltage

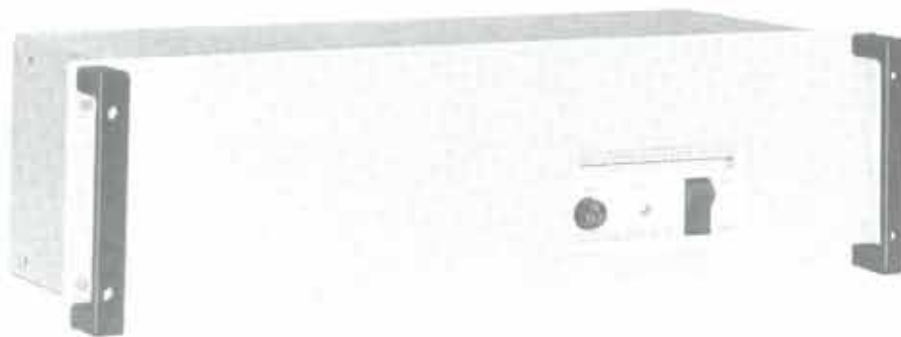

Variac[®] automatic voltage regulator

Type 1591

- capacity to 1 kVA
- 115-V models
- accuracy of $\pm 0.2\%$
- low-cost, compact
- portable and rack models



The small size of the 1591 particularly suits it to portable applications.

Low-cost regulation Electromechanical voltage regulators have always offered large power-handling capacity with minimum bulk and cost. These advantages are now available in a 1-kVA regulator, thanks to a special control circuit. Still, as with the larger GR regulators, there is no distortion added to the input waveform; average-voltage and peak-voltage values are therefore constant, as rms voltage is regulated. Accuracy is independent of line frequency, load current variations, and power factor.

Output voltage is controlled by a servo-driven Variac[®] adjustable autotransformer so the regulator has the same ability to handle 1000% transient overloads as the Variac. The 1591 is mechanically rugged and has proved itself in severe vibration and shock tests. Its typical temperature coefficient of 75 ppm/ $^{\circ}\text{C}$ is so small as to be negligible under normal operating conditions.

— See *GR Experimenter* for October 1967.

SPECIFICATIONS

Principal Characteristics

Description	Type	Input		Output				
		Variation* (range)	Frequency	Voltage* (adjustable)	Current Rating	kVA	Correction Rate**	Regulation*
115 V	1591	100 to 130 V	57 to 63 Hz	105 to 125 V	8.7 A	1	6 c + 1.5 c/V	$\pm 0.2\%$

* Also see curve. Output voltage will remain within regulation with the specified input variation; e.g., when the output is adjusted to 105 V, it will remain there within $\pm 0.2\%$ (0.21 V) with inputs from 100 to 130 V.

** Correction rate is given in terms of c cycles of the power-line frequency.

Output Characteristics: POWER FACTOR: 0 to 1, leading or lagging. RESPONSE: Rms. DISTORTION: None added. REGULATION: Regulation accuracy applies for any combination of line voltage or frequency, load current or power factor. CONTROL: Front-panel screwdriver adjustment.

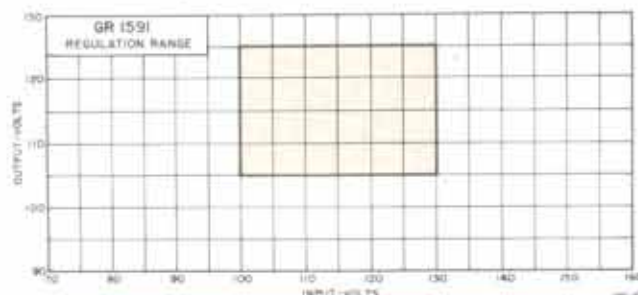

Environment: TEMPERATURE: -20 to $+40^{\circ}\text{C}$ for portable model, -20 to $+52^{\circ}\text{C}$ for rack model; operating. VIBRATION: 0.03 in. from 10 to 55 Hz. BENCH HANDLING: 4 in. or 45° (MIL-810A-VI). SHOCK: 30 g, 11 ms.

Electrical: POWER: ≈ 40 W no load, ≈ 95 W full load.

Mechanical: Portable and rack models. DIMENSIONS (wxhxd): Portable, 12.75x9.5x5.38 in. (324x241x137 mm); rack, 19x5.25x6.38 in. (483x133x162 mm). WEIGHT: Portable, 17 lb (8 kg) net, 25 lb (12 kg) shipping; rack, 22 lb (10 kg) net, 31 lb (15 kg) shipping.

Description	Catalog Number
1591 Variac[®] automatic voltage regulators	
115-V, 60 Hz	
1591-A, Portable Model	1591-9700
1591-AR, Rack Model	1591-9712

Variac® automatic voltage regulator

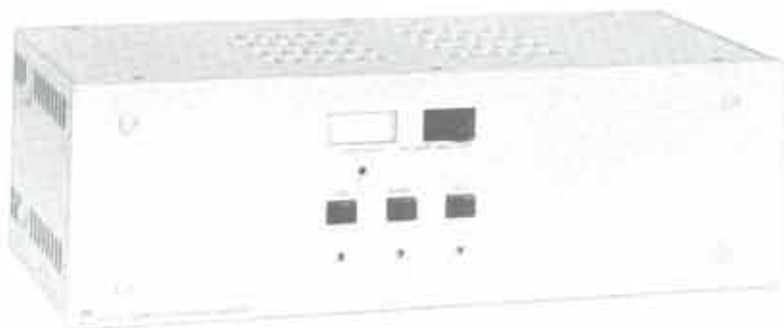

Type 1592

- capacity to 5.3 kVA
- 120-V and 230/240-V models
- accuracy to $\pm 0.25\%$
- lowest-cost regulator per kVA
- remotely programmable
- universal cabinet

Economical performance Regardless of load or line variations, the 1592 supplies the voltage necessary for the proper operation and longevity of your equipment — any equipment from light bulbs to computers — because the regulator adds no distortion and operates independently of power factor.

It is virtually unaffected by temperature, is very fast responding, and is so efficiently engineered and built that only two basic models handle all requirements for

120- to 480-volt, single or multi-phase systems and bench, rack, or wall-mount installations. It is also a versatile test instrument; the output can be programmed manually by means of front-panel pushbuttons, for any sequence of three preset voltages, or remotely with infinite resolution.

Since the 1592 is an electro-mechanical regulator, it provides tight regulation accuracy without regard to line frequency, load variations, or power factor. Its output is controlled by a servo-driven Variac® adjustable autotransformer with a long history of engineering refinements and an ability to handle 1000% transient overloads. The control circuitry is ultra simple and exceptionally reliable due to a unique concept introduced by GR and field-proven (including severe shock and vibration tests) for many years. This circuitry also allows the output voltage to be remotely sensed and controlled.

— See *GR Experimenter* for July/September 1970.

SPECIFICATIONS

Principal Characteristics:

Description	Input		Voltage* (adjustable)	Current Rating	Output		
	Variation* (% of output)	Frequency (Hz)			kVA	Correction Rate**	Regulation*
120 V $\pm 10\%$	$\pm 10\%^{***}$	60†	90 to 130 V***	44 A	5.3	25 ms/V	$\pm 0.3\%$
120 V $\pm 20\%$	$\pm 20\%^{***}$	60†	90 to 130 V***	20 A	2.4	13	$\pm 0.5\%$
230/240 V $\pm 5\%$	$\pm 5\%††$	50 to 60	180 to 260 V††	42 A	10	50 ms/V	$\pm 0.25\%$
230/240 V $\pm 10\%$	$\pm 10\%††$	50 to 60	180 to 260 V††	18 A	4.3	25	$\pm 0.3\%$
230/240V $\pm 20\%$	$\pm 20\%††$	50 to 60	180 to 260 V,†	8.5 A	2	13	$\pm 0.5\%$

* Also see curve. Output voltage will remain within regulation with any specified input variation; e.g. When the output of the 120-V $\pm 10\%$ model is adjusted to 90 V, it will remain within $\pm 0.3\%$ (0.27 V) of 90 V with inputs of $\pm 10\%$ of 90 V (81 to 99 V).

** Correction is slow speed at 60-Hz operation.

† Can be operated at 50 Hz if output is limited to 115 V.

*** Can be increased to 138 V (for use in 240-V, 3-phase, 4-wire systems) with 9 and 18% input variations, respectively.

†† Can be increased to 277 V (for use in 60-Hz, 480-V, 3-phase, 4-wire systems) with 5, 9, and 18% input variations, respectively.

Output Characteristics: POWER FACTOR: 0 to 1, leading or lagging. RESPONSE: Rms. DISTORTION: None added. REGULATION: Regulation accuracy applies for any combination of line voltage or frequency, load current or power factor. CONTROL: Output can be rapidly switched among 3 levels by front-panel pushbuttons, each level independently adjustable by front-panel screwdriver controls or, for remote-control applications, by external resistors connected to rear by push-on terminals; TTL programming of level change available. Voltage can also be sensed remotely by 2 leads connected to rear by push-on terminals; use these to ensure desired voltage at the load and compensation for wiring IR drop. RANGE OF

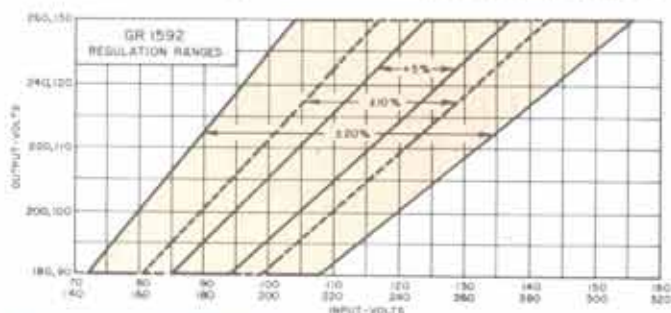

OUTPUT LEVELS V_{out} for specified regulation: See curves. Examples: $\pm 20\%$ model, $90 < V_{in} < 130$ V for input variation of 104 to 108 V; $100 < V_{in} < 120$ V for 96 to 120 V; $\pm 5\%$ model, $113 < V_{in} < 117$ V for 112 to 118 V input variation.

Meter: Front-panel pushbutton permits meter to read input or output. RANGE: 80 to 160 V (160 to 320 V). ACCURACY: $\pm 2\%$ at nominal 120/240-V reading; tracking accuracy, $\pm 5\%$.

Electrical: There are two basic models, 120-V and 230/240-V input, whose only major differences are the meter and Variac adjustable autotransformer. The various versions of each model are achieved by internal wiring changes that can be effected simply in the field if desired. POWER: ≈ 45 W no load, ≈ 120 W full load.

Mechanical: Bench, rack, and wall mount (brackets, handles, and hardware supplied for conversion). DIMENSIONS (wxd): 17x5.25x11 in. (432x133x279 mm). WEIGHT: 42 lb (20 kg) net, 56 lb (26 kg) shipping.

Description	Catalog Number
1592 Variac® automatic voltage regulator	
120-V $\pm 10\%$ Model	1592-9700
120-V $\pm 20\%$ Model	1592-9701
230/240-V $\pm 5\%$ Model	1592-9702
230/240-V $\pm 10\%$ Model	1592-9703
230/240-V $\pm 20\%$ Model	1592-9704

TTL-Programmable Models, on request



Variac® automatic voltage regulator

Type 1571

- capacity to 5.8 kVA
- 115-V models
- accuracy to $\pm 0.25\%$
- militarized
- rack models

MIL specifications The 1571 regulators are essentially versions of the 1581 which are designed to meet the appropriate sections of military specifications MIL-E-4158B

SPECIFICATIONS

Principal Characteristics:

Description	Type	Input		Output				
		Variation* (% of output)	Frequency (Hz)	Voltage* (adjustable)	Current Rating	kVA	Correction Rate**	Regulation*
115 V $\pm 10\%$, 60 Hz	1571-AL	$\pm 10\%$	57 to 63†	103 to 127	50 A	5.8	2.5 c + 1.5 c/V	$\pm 0.25\%$
115 V +24 -18%, 60 Hz	1571-AL2	+24 -18%	57 to 63†	103 to 127	25 A	2.9	2.5 c + 0.7 c/V	$\pm 0.5\%$
115 V $\pm 10\%$, 400 Hz	1571-ALJ	$\pm 10\%$	350 to 450	103 to 127	50 A	5.8	17.5 c + 10.5 c/V	$\pm 0.25\%$
115 V +24 -18%, 400 Hz	1571-AL2J	+24 -18%	350 to 450	103 to 127	25 A	2.9	17.5 c + 4.9 c/V	$\pm 0.5\%$

* Also see curve. Output voltage will remain within regulation with the specified input variation; e.g. When the output of the model in the first row is adjusted to 103 V, it will remain there within $\pm 0.25\%$ (0.26 V) with inputs of 103 V $\pm 10\%$ (93 to 113 V).

** Correction rate is given in cycles of line frequency, c.

† Will operate from 48 to 63 Hz with internal wiring change that incidentally reduces variation by about 1/10, i.e., to $\pm 9\%$, and +19 -16%.

Output Characteristics: POWER FACTOR: 0 to 1, leading or lagging. RESPONSE: Rms. DISTORTION: None added. CONTROL: Front-panel screwdriver adjustment. REGULA-

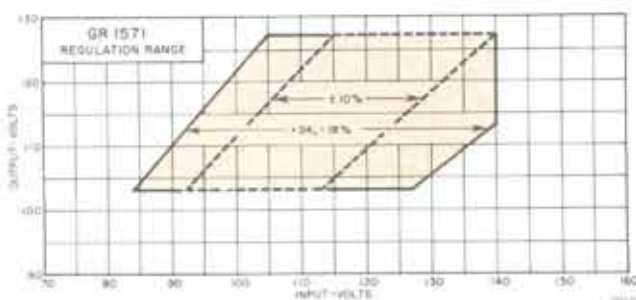

and MIL-E-16400C. These rugged models are particularly useful where mechanical shock or vibration is encountered. We offer models for nominal power-line frequencies of 400 Hz and others for 60 Hz (adaptable by reconnection for either 60 Hz or 50-to-60 Hz). You have a further choice of output current ratings and correction ranges.

The regulator comprises a motor-driven Variac® adjustable autotransformer, an auxiliary step-down transformer that multiplies the power rating of the autotransformer, and a solid-state control unit that automatically positions the autotransformer to hold the rms output voltage constant. The true proportional control system provides both fast correction and smooth control.

TION: Regulation accuracy applies for any combination of line voltage or frequency, load current or power factor.

Environment: Appropriate sections of MIL-E-4158B and MIL-E-16400C. TEMPERATURE: -29 to +52°C operating, -54 to +85°C storage.

Electrical: POWER: ≈ 35 W no load, ≈ 115 W full load.

Mechanical: Rack models. DIMENSIONS (wxhxd): 19x7x12 in. (483x178x305 mm). WEIGHT: 53 lb (25 kg) net, 103 lb (47 kg) shipping.

Description	Catalog Number
1571 Variac® automatic voltage regulators	
115-V Models	
1571-AL, $\pm 10\%$, 60 Hz \diamond	1571-9831
1571-AL2, +24 -18%, 60 Hz \diamond	1571-9898
1571-ALJ, $\pm 10\%$, 400 Hz	1571-9551
1571-AL2J, +24 -18%, 400 Hz	1571-9556

\diamond Federal stock numbers are listed before the index.



Variac[®] automatic voltage regulators

Types 1581 and 1582

- capacity to 19.7 kVA
- 115-V, 230-V and 460-V models
- accuracy to $\pm 0.25\%$
- highest-capacity GR regulators
- wall, bench, and rack models

High capacity, low cost The 1581 and 1582 all-solid-state regulators automatically compensate for ac line-voltage fluctuations to provide a reliable constant-voltage source over a wide correction range. The true propor-

tional control system provides both fast correction and smooth control.

These regulators give you high accuracy with large capacity for both laboratory and industrial installation. They are especially useful for computers, measurement systems, transmitter supplies, and critical industrial processes.

A large variety of models provides you a choice of 115-, 230-, or 460-V operation on 50-, 60-, or 400-Hz lines with loads up to 19.7 kVA; models are available for wall, rack, or bench use. The units are described as single-phase regulators but they can regulate three-phase lines. For example, two regulators can be used in an open-delta configuration and three can be used in wye or closed-delta configurations.

SPECIFICATIONS

Principal Characteristics:

Description	Type	Input		Output				
		Variation* (% of output)	Frequency** (Hz)	Voltage* (adjustable)	Current Rating	kVA	Correction Rate†	Regulation*
115 V $\pm 10\%$, 50 A	1581-AL	$\pm 10\%$	57 to 63	103 to 127 V	50 A	5.8	2.5 c + 1.5 c/V	$\pm 0.25\%$
115 V $\pm 10\%$, 85 A	1582-AL	$\pm 10\%$	57 to 63	103 to 127 V	85 A	9.8	2.5 c + 3 c/V	$\pm 0.25\%$
115 V +24 -18%, 25 A	1581-AL2	+24 -18%	57 to 63	103 to 127 V	25 A	2.9	2.5 c + 0.7 c/V	$\pm 0.5\%$
115 V +24 -18%, 42.5 A	1582-AL2	+24 -18%	57 to 63	103 to 127 V	42.5 A	4.9	2.5 c + 1.5 c/V	$\pm 0.5\%$
230 V $\pm 5\%$, 40 A	1581-AH5	$\pm 5\%$	57 to 63	206 to 254 V	40 A	9.2	2.5 c + 1.5 c/V	$\pm 0.25\%$
230 V $\pm 5\%$, 85 A	1582-AH5	$\pm 5\%$	57 to 63	206 to 254 V	85 A	19.7	2.5 c + 3 c/V	$\pm 0.25\%$
230 V $\pm 10\%$, 20 A	1581-AH	$\pm 10\%$	57 to 63	206 to 254 V	20 A	4.6	2.5 c + 0.7 c/V	$\pm 0.25\%$
230 V $\pm 10\%$, 42.5 A	1582-AH	$\pm 10\%$	57 to 63	206 to 254 V	42.5 A	9.8	2.5 c + 1.5 c/V	$\pm 0.25\%$
230 V +24 -18%, 10 A	1581-AH2	+24 -18%	57 to 63	206 to 254 V	10 A	2.3	2.5 c + 0.4 c/V	$\pm 0.5\%$
230 V +24 -18%, 21.3 A	1582-AH2	+24 -18%	57 to 63	206 to 254 V	21.3 A	4.9	2.5 c + 0.7 c/V	$\pm 0.5\%$
460 V $\pm 5\%$, 34 A	1582-AK5	$\pm 5\%$	57 to 63	412 to 508 V	34 A	15.6	2.5 c + 1.5 c/V	$\pm 0.25\%$
460 V $\pm 10\%$, 17 A	1582-AK	$\pm 10\%$	57 to 63	412 to 508 V	17 A	7.8	2.5 c + 0.7 c/V	$\pm 0.25\%$
460 V +24 -18%, 8.5 A	1582-AK2	+24 -18%	57 to 63	412 to 508 V	8.5 A	3.9	2.5 c + 0.4 c/V	$\pm 0.5\%$

* Also see curve. Output voltage will remain within regulation with the specified input variation; e.g., When the output of the model in the first row is adjusted to 108 V, it will remain there within $\pm 0.25\%$ (0.27 V) with inputs of 108 V $\pm 10\%$ (97 to 119 V).

† Correction rate is given in c cycles of the line frequency. With the 400-Hz option, correction time is about the same, so multiply the tabulated rate by 7.

** Will operate from 48 to 63 Hz with internal wiring change that incidentally reduces variation by about 1/10 (to 5%, 9%, +19 - 16%). With 400-Hz option, will operate from 350 to 450 Hz.

Output Characteristics: POWER FACTOR: 0 to 1, leading or lagging. RESPONSE: Rms. DISTORTION: None added. CONTROL: Front-panel screwdriver adjustment. REGULATION: Regulation accuracy applies for any combination of line voltage or frequency, load current or power factor.

Environment: TEMPERATURE: -20 to +52°C operating; -54 to +85°C storage.

Electrical: POWER: 1581: ≈ 35 W no load, ≈ 115 W full load. 1582: ≈ 45 W no load, ≈ 120 W full load.

Mechanical: Bench, rack, or wall mount. 1581: DIMENSIONS: 19x7x10.5 in. (483x178x267 mm); for cabinet add 2 in. (51 mm) to depth. WEIGHT: 42 lb (19 kg) net, 92 lb (42 kg) shipping; for cabinet add 6 lb (3 kg) to net and 12 lb (6 kg) to shipping. 1582: DIMENSIONS: 19x7x14.25 in. (483x178x362 mm); for cabinet add 2 in. (51 mm) to depth. WEIGHT: 61 lb (28 kg) net, 110 lb (50 kg) shipping; for cabinet add 15 lb (7 kg) to net and 16 lb (8 kg) to shipping.



Your choice of regulator enclosures: Top, without cabinet; left, wall-mountable cabinet; right, convertible to either bench or rack-mounted use.

Description

Catalog Number

Variac® automatic voltage regulators

(Unless options are specified, all come for line frequency 60 Hz, without cabinets)

115-V Models

- 1581-AL, ±10%, 50 A
- 1582-AL, ±10%, 85 A
- 1581-AL2, +24-18%, 25 A
- 1582-AL2, +24-18%, 42.5 A

230-V Models

- 1581-AHS, ±5%, 40 A
- 1582-AHS, ±5%, 85 A
- 1581-AH, ±10%, 20 A
- 1582-AH, ±10%, 42.5 A
- 1581-AH2, +24-18%, 10 A
- 1582-AH2, +24-18%, 21.3 A

460-V Models

- 1582-AKS, ±5%, 34 A
- 1582-AK, ±10%, 17 A
- 1582-AK2, +24-18%, 8.5 A

Select the following options, as desired

- OP1 Bench Cabinet
- OP2 Rack Cabinet
- OP3 Wall Cabinet
- OP4 400-Hz Line Frequency

(Describe exactly as shown at the left.)

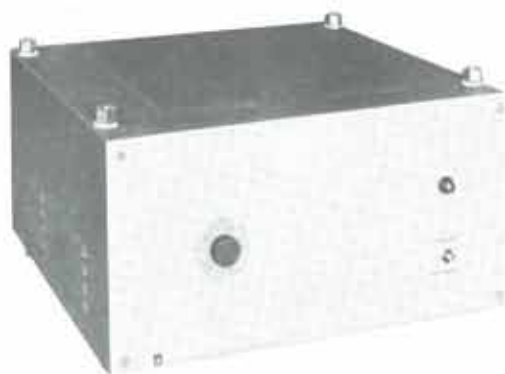

Variac® automatic voltage regulators

Type 1585

- 1% output accuracy
- high power — up to 300 kVA 3-phase
- distortion-free regulation
- any load power factor
- transient overloads up to 1000%

The 1585 series of automatic voltage regulators, described only briefly here, is particularly appropriate for customers in Europe, or those who can readily import from Europe. These regulators, like the 1581 and 1582 models, for example, feature the efficiency and voltage-waveform preservation of transformer coupling from the power line to your load, with the turns ratio continuously and automatically adjusted to maintain the constant rms terminal voltage you select.

A large number of standard versions are readily available; specials also upon request. Standard features include single- or three-phase networks, standard power-line voltages and frequencies, mountings (presentation) of three kinds — portable, rack-or-bench, and housed in a stackable metal cabinet. Models are available with voltmeters.

— Note: This product is manufactured only in Europe.



SPECIFICATIONS

— for standard versions:

Power: Up to 300 kVA (3-phase).

Frequency: 48 to 63 Hz.

Output Voltage: Adjustable over a range of ±10% from a nominal 127 or 220 V, single phase, set by a front-panel screwdriver control. RESPONSE: Rms. DISTORTION: None added by the regulator.

Variac® adjustable autotransformers

What is a Variac?

Applications

How to Select a Variac

New — the U2

General Specifications

Single-Phase Models

Three-Phase Models

400-Hz Models

Portable Models

Motor-Driven Versions

Basic Data for Single Sections

Get More Out of Your Variac



Variac® Adjustable Autotransformer

What Is a Variac?

The Variac® autotransformer is an efficient, trouble-free device for controlling ac voltage and any other quantities that derive from ac voltage: heat output, light intensity, motor speed, and the outputs of various power supplies. The name Variac comes from the unit's function—"vary ac"—and is General Radio's registered name for its continuously adjustable autotransformer.

Unlike most transformers, the Variac has a transformation ratio that can be smoothly and continuously changed so the output of the unit can be controlled from zero to line voltage or even higher. Because it is a transformer, the Variac is

- **efficient** transforms power more efficiently than rheostats
- **durable** because it runs cool
- **overload-able** withstands 1000% short-term overloads
- **independent of load size or power factor** voltage to the load changes little from full load to none

Applications

In most applications, a full turn of the Variac control shaft (320°) varies the output voltage, applied to the load, from zero to line voltage or 17% above if connected for "overvoltage" operation. Thus, the light or heat output or speed or torque of the load is varied from zero to rated or above. Some typical applications are shown below.

Voltage doubling If the available line voltage is only about half that required by the load, the Variac can double the voltage while providing full control of the output. Units designated by an "H" (W20H) are supplied with an input connection for this use; output current rating of the transformer is one-half its normal value in this case. On special order, similar connections for other multiplying ratios can be supplied.

Other applications The Variac autotransformer can also be used as a phase-shifter in three-phase circuits, as a color-temperature control, for calibrating voltmeters, ammeters, and wattmeters, and in many unique applications. It is the basis of a wide line of General Radio automatic line-voltage regulators and can be used in many similar custom applications.

Special models General Radio welcomes inquiries concerning special models. We can, for example, modify taps, include limit switches, change shaft length, add ball

- **quiet** adds no noise or distortion to the line
- **reliable** exclusive Duratrak® contact surface prevents injurious high-temperature oxidation and resultant brush-track deterioration

In addition, the Variac is

- **easy to install.** All mounting hardware is included; wiring diagram is on the terminal plate; conduit knockouts are included on all enclosed models.
- **available in hundreds of standard versions** to satisfy line frequency, voltage, and phase requirements, load size, mounting demands (including portable and metered models). They can be supplied with motor drives, ball bearings, and in ganged assemblies to increase basic line-voltage and load-current ratings.
- **assured safe** by Underwriters' Laboratory listing and Canadian Standards approval of many models
- available in militarized models specifically designed for 400-Hz operation

bearings, provide for 360° mechanical rotation, add one or more independently controlled brushes, treat the units with fungicide or otherwise prepare them for use in abnormal environments.

Typical Applications for Variac® autotransformers

Type of Load	Function Controlled
Incandescent Lamps	Brilliance and color temperature Brilliance (special circuitry required for best results)
Fluorescent Lamps (both hot- and cold-cathode types)	
Heating Devices (resistive heaters and infra-red lamps)	Temperature
Motors	Use only on fan loads, or where torque is proportional to speed
AC Motors	
Universal Series	
Repulsion	
Two-phase	
Shaded-pole	
Split-phase induction	
Capacitor split phase	
DC Motors	Use with rectifier for motor-speed control
Rectifiers	Current Voltage
Electroplating	
Power and plate circuits	
Solenoids	Force
Test Loads	High and low line-voltage testing, breakdown tests

How to Select a Variac

The Variac® adjustable autotransformers are grouped by line frequency, voltage, and phase, with brief specifications for each model.* Within each group, the units are listed in order of increasing load rating that can be expressed in either current (amperes) or power (kVA). To make the selection you must know the line and load characteristics for your application. A brief look at these quantities may help.

Line frequency Most Variac models in the "W" series are designated for 50-to-60 Hz operation ("L" models are for 60 Hz only). Some "W" models can be used, without being derated, up to at least 400 Hz, but the regulation will be greater than normal and the physical size and weight larger than necessary. Therefore, we offer the "M" series Variac that is designed for operation from 350 to 1200 Hz. The M-series units are smaller and have better regulation at the higher frequencies. When series connected or when ordered specially, these units will also operate from 240-V lines.

Phase Variac models are available for both single- and three-phase operation. In general, three-phase ratings are governed by the ratings of each individual transformer in the assembly. That is, the voltage applied to, or the current drawn from, each individual unit must not exceed that specified for its single-phase uses. Thus, the considerations discussed below for single-phase applications apply separately to each unit in a three-phase assembly. A more detailed discussion on three-phase ratings and how to calculate them is given later in this section.

Line voltage Single-phase lines are normally either 120-volt or 240-volt, and GR Variac models come in two basic families to match. Should your line voltage be less than nominal, a unit rated for the nominal value will operate perfectly with no derating in current. Line voltage up to 17% above the nominal can be applied if overvoltage output is not required. For example, up to 140 volts line voltage can be applied to nominal 120-volt models if the maximum output voltage required is no more than the line voltage applied.

For single-phase line voltages from 480 to 560 volts, two Variac units rated for 240-V operation must be used with their coils connected in series across the line and the load connected one side to each of the Variac outputs. For such use, the load cannot be grounded at any point.

Load rating The load capacity of GR Variac autotransformers is specified in three ways: maximum current, rated current in amperes, and power in kVA (kilovolt-amperes). Although closely related, they are different and the differences are important to the proper selection of your Variac.

An autotransformer cannot supply as much current at midrange settings as it can at full-voltage setting without overheating. Yet some nonlinear loads, incandescent lights for example, may draw nearly as much current at

half voltage as they do at rated voltage, while other (linear) loads will draw current proportional to the applied voltage. As a general rule, if the load is nonlinear, or if the overvoltage connection is used to apply more than line voltage to the load, a Variac should be chosen that has a Rated Current adequate for the load. Otherwise, the larger Maximum Current is the load-rating limit. Special applications may permit higher current to be drawn; for a more complete discussion of ratings, see "Get More Out of Your Variac," later in this section.

The Variac power rating in kVA is given as a convenience in matching the right Variac to the load. It is the product of the rated line voltage and the *maximum* current rating of the Variac. There is a risk of misinterpreting it and exceeding the limits mentioned above; the kVA rating can be used only if the load is linear and the overvoltage connection is *not* used. Otherwise, load current must be determined and a Variac selected that has adequate rating.

Power ratings in kVA are given for three-phase Variac applications and must be interpreted as described above.

Trade-offs While some trade-offs, like those mentioned above, are included in the selection tables, there are others you may wish to consider. The load-current capacity of the Variac is limited by temperature and life. Specified ratings assume a maximum ambient temperature of 50°C and a minimum life span of 7 years. If the expected ambient is lower or forced cooling is possible, the autotransformer can be uprated without affecting life. Also, if a shortened life is not a problem in your application, a further uprating can be realized.

Finally, if the load is expected to be switched on and off regularly (as with a thermostatically-controlled heater), the Variac can be uprated. In general, if the time for an on-off cycle is 2 hours or less and the off time is 10% or more of the total cycle time, some significant improvement in rating can be realized.

Calculations and curves for duty-cycle and temperature are given in detail later in this section.

Selecting the proper Variac Autotransformer Knowledge of the line frequency, voltage, and phase of your application will lead you to one of several tables that follow. The considerations above will have helped you determine the current or power that the Variac must be capable of handling. Now, merely scan down the left columns in the table ("Rated Current," "Maximum Current," or "kVA") until you find an entry that equals or exceeds the value determined by your load. It may be rewarding to consider several models, including those with slightly higher ratings than necessary, as there is the possibility of saving money, space, or both. Some models (designated "L" as in W5L) offer higher ratings per dollar and have only the minor restrictions of 60-Hz operation only and no overvoltage connection.

Parallel connections In some instances, the selection tables will indicate that the ganged assembly you have chosen requires parallel connection of the individual

* Models made in Europe are not described here.

units. Reference is made to a Type W50-P1 Choke, which *must* be used between the output connections of the individual units in the assembly to prevent one unit from forcing current into another, possibly causing excessive temperature and early failure. One choke is needed if two units are to be paralleled; three or more parallel units require one choke for each Variac. The chokes are *not* included with the ganged assembly and must be ordered separately (except for 9- and 12-gang W50 and W50H units which are shipped *with* chokes).

How to order When you have chosen the right Variac autotransformer from the selection tables, record the 8-digit catalog number and type number. Your order should include this information and a complete description of the unit. This permits us to cross-check your order and catch any typographic errors.

Note that there are no 8-digit numbers given for motor-driven or ball-bearing models; ordering should be done by a constructed type number (see below) and full description.

Models shown in the following lists may be ordered from GR at Concord, Massachusetts or your appropriate Regional Center or sales representative; refer to the front of the catalog. Of course, any of these offices will gladly assist you in selecting a standard Variac autotransformer or considering a special design to match your exact needs.

Made in Europe Many customers will undoubtedly want to obtain catalog information on the Variac product line made in Europe. Please direct your inquiries to General Radio (Overseas); the address is given in the front of the catalog.

Type Number Terminology

In their various combinations, type numbers for Variac autotransformers consist of letters and numerals that indicate exactly what elements are included in each assembly. The following examples show the various combinations:

M	350-to-1200 Hz operation
W	50-to-60 Hz operation
W5	Model size, 120 V input
W5H	240-V input
W5L	60-Hz only, no overvoltage
W5HG2	2-gang W5H (substitute 3 for 3-gang, etc)
W5HG2BB	Adds ball bearings
W5HG2BBM	Adds complete enclosure
W5HG2D4CK	D indicates motor drive; 2, 4, 8, 16, 32, 64, or 128 following D indicates number of seconds for full traverse. C indicates phase-splitter capacitor and K indicates limit switches. Omit BB from motor-drive type numbers since motor-driven units are always equipped with ball bearings.
W5MT	Portable units with 2-wire line cord
W5MT3	With 3-wire line cord
W5MT3VM	With voltmeter
W5MT3A	With voltmeter and ammeter
W5MT3W	With voltmeter and wattmeter
W5MT3AW	With voltmeter, ammeter and wattmeter

Variac® adjustable autotransformer—U2



New

Low-cost versatility The U2, a new low-cost adjustable autotransformer from GR, features simplified mounting for a variety of low-current control applications. It can be used with any input up to 120 volts, 60 to 400 Hz, and provides a full 140-volt output with a 120-volt input.

A single nut secures the autotransformer to any panel up to 3/4-inch thick. The unit's small size allows it to be used on densely packed front-panel configurations—the U2 is a natural for low-current applications in almost any situation.

- lowest cost 2-A unit available
- highest voltage output—up to 140 V
- oversize brush and cooler operation assure extended life
- easily replaced shaft for special applications

SPECIFICATIONS

Input: 120 V, 60 to 400 Hz.

Output:	In Air		On Aluminum Panel	
	0 to 120 V; 0 to 140 V;	2 A rated 2 A rated	2.25 A max 2 A max	2.25 A rated 2.25 A rated

Mechanical: Single-hole mounting of 0.375 in. (10 mm) for shaft plus 0.1875-in. (5-mm) hole for anti-rotation stop, max panel thickness 0.25-in. (6 mm). DIMENSIONS (wxhxd) behind panel) 3.25x3.69x2.94 in. (83x94x75 mm). WEIGHT: 2.5 lb (1.2 kg) net, 3 lb (1.4 kg) shipping.

Description	Catalog Number
U2 Variac® adjustable autotransformer	3200-5110

General Specifications

Ball Bearings Ball bearings at both ends of the shaft are offered for all units. They are useful where more precise alignment, more constant torque, and longer life are required. Ball bearings are standard on all motor-driven Variac® autotransformers, and on all 4- to 12-gang types W30, W30H, W50, and W50H manually-operated models.

Connections, Output "Line-voltage connection" refers to the connection of the Variac autotransformer for an output-voltage range of zero to line voltage. "Overvoltage connection" refers to the input-voltage connection for a range of output voltage from 0 to 117% of line voltage.

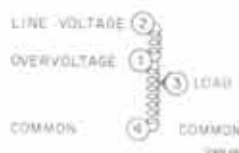

Current, Maximum Maximum current can be drawn at maximum voltage only when the line-voltage connection is used.

Current, Rated This current can be drawn at any dial setting, independent of overvoltage or line-voltage connection.

Dial Dial plates for single units are reversible. They read 0 to 120 volts output on one side and 0 to 140 volts on the other. H models have similar scale readings of 0 to 240 and 0 to 280. Dial plates are calibrated for mounting on a panel or on the front of a case; output voltage increases with clockwise rotation of the knob. All ganged assemblies are supplied with dials calibrated on one side only, reading 0 to 10.

Frequency, Line W-series units are specified for 50-to-60 Hz service except for the L types which are for 60-Hz service only.

However, both of these units can be operated at rated values at line frequencies to 400 Hz. For 350-to-1200 Hz service the M-series units are preferred. Models intended for 240-volt, 60-Hz service can be used at 25 Hz at their normal current rating but at one-half their 60-Hz voltage rating.

kVA Ratings The kVA rating is the maximum load current multiplied by the nominal input line voltage.

Resolution Variac resolution is virtually infinite as the resistive brush always spans 2 or more turns of the autotransformer winding.

Motor-Driven Units All Variac autotransformers, both single and ganged units, can be furnished with motor drive.

Mounting Hardware All models are supplied with the necessary mounting hardware.

Special Designs We welcome requests for modifications of any model. These include different windings, shifting taps, different shafts, or basic new designs to furnish output voltages or voltage ranges differing from standard models. On special order, all W-series Variac autotransformers can be manufactured to conform to military requirements that are standard with the M-series units.

Temperature Rise Ratings are based upon operation at ambient temperatures of up to 50°C. When the ambient temperature exceeds this figure, current ratings should be decreased (see Figure 2).

Terminals All models have combined soldering and screw-type terminals with the exception of the types W30 and W50 which are equipped with clamping terminals. Models for 120-volt lines have five terminals for either 120- or 140-volt maximum output connections; 240-volt units have two extra terminals to provide for either 120- or 240-volt input for 280-volt output.

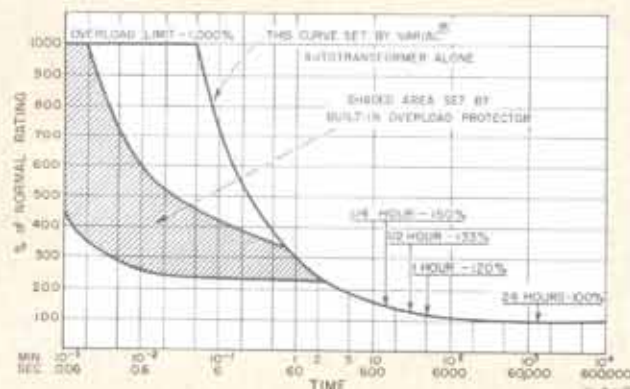

Figure 1. Short-time overload characteristic of Variac autotransformers with line-voltage connection.

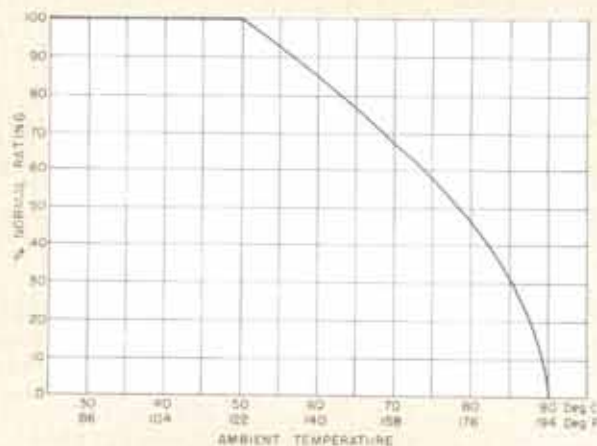

Figure 2. Variac autotransformer derating versus ambient temperature.

General Specifications (Cont'd)

Military Environmental Specifications Most Variac autotransformers have been tested and do meet some or all of the following Military Specifications: MIL-STD-202, MIL-STD-810, MIL-STD-167, MIL-E-4158, MIL-E-4970, MIL-E-5272, MIL-E-5400, MIL-E-16400, MIL-R-23098, MIL-S-901C, MIL-T-945, and MIL-T-5422. "Certification of Compliance" can be furnished at no charge for units tested. Copies of the test data are also available for a small fee. For further information on environmental tests, please contact your local GR District Office.

Overload Protection Today's improved core materials permit the use of higher flux densities than were formerly practical. Under certain conditions of core magnetization and line-voltage phase, an inrush transient or surge having an initial value up to ten times the rated current of the unit may occur. This does no harm except to ordinary "quick-blow" fuses. For this reason, time-current integrating circuit breakers or "slow-blow" fuses are recommended for primary protection. They will hold during transients but will protect against sustained and potentially damaging overloads. Such a protective device on the *input* side of the Variac should be capable of handling a 1000% overload for the duration of one cycle of the power-line frequency.

Overload protection for variable-ratio transformers differs from that used with fixed-ratio transformers, where safe primary and secondary currents are determined by the ratio of secondary to primary turns. For example, in a fixed-ratio transformer having 100 primary turns and 20 secondary turns, if the safe secondary current is 10 amperes, the safe primary current will be 2 amperes. Equal protection will be provided by a 10-ampere secondary fuse or a 2-ampere primary fuse.

This is not true with Variac autotransformers. As the brush traverses the winding, the transformation ratio continually changes. Under the conditions of a varying transformation ratio, primary protection is of little or no value, but output protection is all important; *it is the output current that must be held within safe limits.* For this reason a Variac autotransformer should be protected by a fuse or circuit breaker in the brush lead, where the load is normally connected.

The nature of the protective devices selected should be partially determined by the service requirements. Variac autotransformers have an inherently high short-time overload capacity because temperature is dependent upon time for a given rise. They can safely absorb relatively infrequent short-time overloads (due to motor starting or lamp inrush) without being derated.

The upper curve in Figure 1 applies to units without built-in fuse protection. Models with built-in protection in the brush arm (models W5L, W20H, W30, W30H, W50, and W50H) have overload characteristics corresponding to the shaded area on the curve. The fuse is purposely made inaccessible to guard against careless replacement with fuses of wrong value. Its basic purpose is to provide thermal protection to the autotransformer, and it is not intended to serve as the sole protective device for the unit. It is essential that the user add ex-

ternal overload protection to the output of the variac, that is, between the brush and the load.

To benefit fully from the short-term overload characteristic, the overload capacity must not be unduly limited by the protective device. Since quick-blow fuses cannot withstand surges, their use is discouraged except for loads not subject to inrush. Slow-blow fuses are better; time-current integrating circuit breakers are better still. Thermal breakers are to be preferred, since they automatically derate with increasing ambient temperature. They most nearly conform to the requirements shown in Figure 2. This type of protector is standard in the Type MT (portable, cased) models of the W-series Variac autotransformers.

Regulation Regulation is defined as the change in output voltage from no load to full load current (varying load resistance), with constant input voltage, and is expressed as a percentage of line voltage.

In an autotransformer, regulation varies with dial setting, largely because of IR drop in the winding, and is minimum at transformation ratios of zero and one. Note that, at zero and one line-voltage settings, there is some slight regulation attributable to the resistance of the brush. Regulation is also due in part to leakage reactance caused by stray flux that does not link all the turns. While this is a minor factor at low frequencies, it becomes dominant at some higher frequency and actually imposes an upper-frequency limit on the operation of the autotransformer. This limit depends on the load conditions.

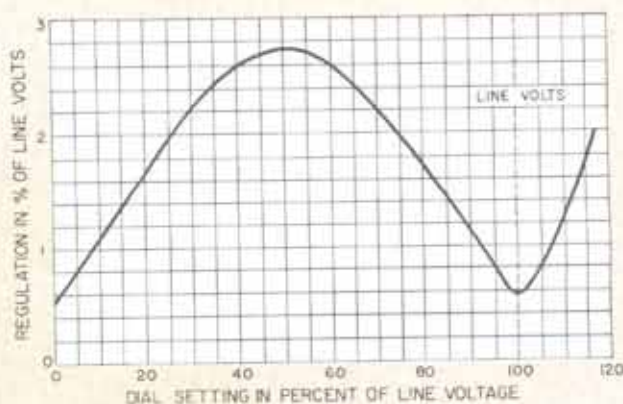

Typical regulation curve with normal rated current.

Paralleling Choke, W50-P1 Many of the Variac autotransformers listed on the following pages are indicated to require one or more Type W50-P1 Chokes (catalog number 3150-5016). This unit is used when two or more autotransformer outputs are to be connected in parallel; it impedes the flow of potentially destructive-circulating currents. Instructions for proper interconnecting are included with each unit.

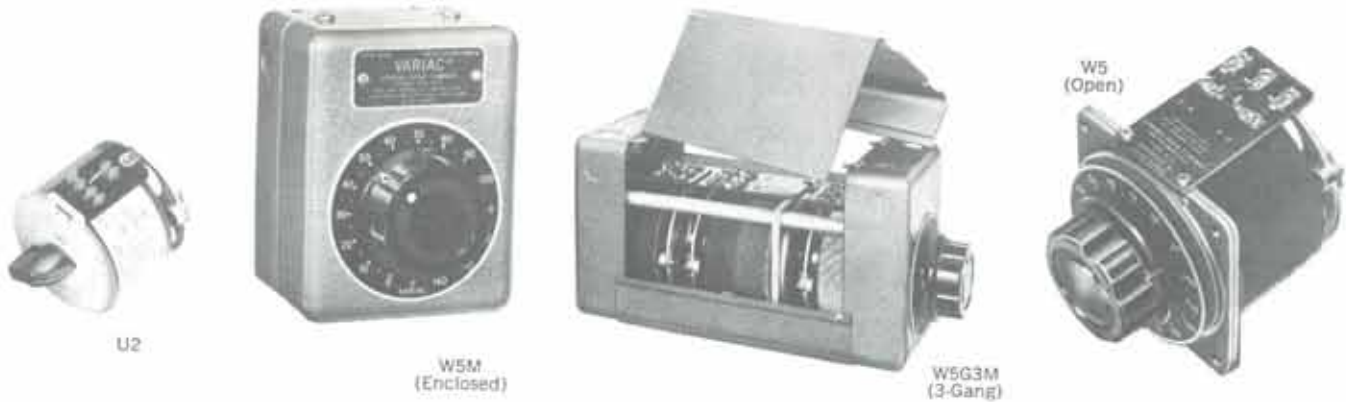

Single-phase, 120-volt input, 50-60 Hz

Output				Description									
Rated Current Amperes	Max Current Amperes	kVA	Max Output Voltage Range	Type	Mounting	Notes	W50-P1 Chokes Req'd for parallel operation	Catalog Number	Net Weight lb	Shipping Wt lb	Outline Dimensions (inches)		
											W	H	D
2.0	3.0		0-140	U2	⊕	Open		3200-5110	2.5	3	3 1/4	3 1/4	2 1/4
2.0	2.6	0.31	0-140	W2M	⊕	Encl		3010-5111	4	9	4 1/2	5 1/4	4 1/2
2.4	3.1	0.37	0-140	W2	⊕	Open		3010-5110	3	4	3 1/2	3 1/2	3 1/2
5.0	6.5	0.78	0-140	W5M	⊕	Encl		3030-5111	7	13	4 1/2	6 1/4	4 1/2
6.0	7.8	0.94	0-140	W5	⊕	Open		3030-5110	6	8	4 1/2	4 1/4	3 1/4
7.1	9.2	1.1	0-120	W5LM	⊕	Encl	60 Hz only	3050-5111	7	13	4 1/2	6 1/4	4 1/2
8.5	11.0	1.32	0-120	W5L	⊕	Open	60 Hz only	3050-5110	7	8	4 1/2	4 1/4	4 1/4
8.5	11.0	1.32	0-140	W8	⊕	Open		3038-5110	8	9	4 1/2	4 1/4	4 1/4
10.0	13.0	1.56	0-120	W8L	⊕	Open	60 Hz only	3058-5110	8	12	4 1/2	4 1/4	4 1/4
10.0	13.0	1.56	0-140	W10	⊕	Open		3060-5110	12	13	5 1/2	6 1/4	3 1/4
10.0	13.0	1.56	0-140	W10M	⊕	Encl		3060-5111	15	17	6 1/2	9 1/2	5 1/2
14.2	18.4	2.2	0-120	W5LG2M		Encl	60 Hz only	3050-5121	15	23	5 1/2	6 1/4	8 1/4
17.0	22.0	2.6	0-120	W5LG2		Open	60 Hz only	3050-5120	14	16	4 1/2	4 1/4	8
17.0	22.0	2.6	0-140	W8G2		Open		3038-5120	16	19	4 1/2	4 1/4	9 1/4
20.0	26.0	3.12	0-140	W20	⊕	Open		3090-5110	21	24	7 1/2	8 1/4	4 1/2
20.0	26.0	3.12	0-140	W20M	⊕	Encl		3090-5111	24	29	8 1/2	11 1/4	5 1/2
20.0	26.0	3.1	0-120	W8LG2		Open	60 Hz only	3058-5120	17	19	4 1/2	4 1/4	9 1/4
21.3	27.6	3.3	0-120	W5LG3M		Open	60 Hz only	3050-5131	22	32	5 1/2	6 1/4	12 1/2
25.5	33.0	4.0	0-120	W5LG3	⊕	Open	60 Hz only	3050-5130	20	22	4 1/2	4 1/4	12 1/2
25.5	33.0	4.0	0-140	W8G3	⊕	Open		3038-5130	25	27	4 1/2	4 1/4	13 1/4
28.0	32.0	3.84	0-140	W30M		Encl		3120-5111	37	47	11	14 1/4	8 1/2
30.0	36.0	4.32	0-140	W30	⊕	Open		3120-5110	30	38	10	11 1/4	4 1/2
30.0	39.0	4.7	0-120	W8LG3		Open	60 Hz only	3058-5130	25	27	4 1/2	4 1/4	13 1/4
40.0	52.0	6.2	0-140	W20G2M		Encl		3090-5121	48	56	9	12 1/4	9 1/4
40.0	52.0	6.2	0-140	W20G2		Open		3090-5120	43	48	7 1/2	8 1/4	9 1/4
40.0	45.0	5.40	0-140	W50M	⊕	Encl		3150-5111	57	74	13 1/4	16 1/4	7 1/2
50.0	50.0	6.00	0-140	W50	⊕	Open		3150-5110	50	57	12 1/2	13 1/4	6 1/2
56.0	64.0	7.7	0-140	W30G2M		Encl		3120-5121	67	90	11 1/4	14 1/4	10 1/4
60.0	72.0	8.5	0-140	W30G2		Open		3120-5120	61	80	10	11 1/4	9 1/4
60.0	78.0	9.4	0-140	W20G3M		Encl		3090-5131	71	82	9	12 1/4	13 1/4
60.0	78.0	9.4	0-140	W20G3	⊕	Open		3090-5130	65	71	7 1/2	8 1/4	13 1/4
80.0	90.0	10.8	0-140	W50G2M		Encl		3150-5121	123	160	13 1/4	17 1/4	14 1/4
84.0	96.0	11.5	0-140	W30G3M		Encl		3120-5131	99	125	11 1/4	14 1/4	14 1/4
90.0	108.0	13.0	0-140	W30G3		Open		3120-5130	93	113	10	11 1/4	20 1/4
100.0	100.0	12.0	0-140	W50G2	⊕	Open		3150-5120	112	147	12 1/2	13 1/4	14 1/2
120.0	135.0	16.2	0-140	W50G3M		Encl		3150-5131	179	221	13 1/4	17 1/4	21 1/4
150.0	150.0	18.0	0-140	W50G3		Open		3150-5130	163	206	12 1/2	13 1/4	20 1/2
160.0	180.0	21.6	0-140	W50G4BBM		Encl		3150-5241	240	313	13 1/4	17 1/4	27 1/4
200.0	200.0	24.0	0-140	W50G4BB		Open		3150-5240	215	288	12 1/2	13 1/4	27 1/4
240.0	270.0	32.4	0-140	W50G6BBM		Encl		3150-5261	355	430	13 1/4	17 1/4	40 1/4
300.0	300.0	36.0	0-140	W50G6BB		Open		3150-5260	325	400	12 1/2	13 1/4	40

* Listed under Re-examination Service of the Underwriters' Laboratory.

† Approved by the Canadian Standards Association.

⊕ Federal stock numbers are listed before the index.



W8G2
(2-Gang)



W20M
(Enclosed)



W50
(Open)

Single-phase, 240-volt input, 50-60 Hz

Output				Description									
Rated Current Amperes	Max Current Amperes	kVA	Max Output Voltage Range	Type	Mounting	Connection	W50-P1 Chokes Req'd for parallel operation	Catalog Number	Net Weight lb	Shipping Wt lb	Outline Dimensions (inches)		
											W	H	D
2.0	2.6	0.62	0-280	W5H	⊕	Open		3040-5110	6	8	4 1/2	4 1/8	3 1/2
2.0	2.6	0.62	0-280	W5HM	⊕	Encl		3040-5111	7	13	4 1/2	6 1/8	4 1/2
2.4	3.1	0.74	0-280	W2G2	⊕	Open	Series	3010-5120	7	9	3 1/2	3 1/8	7 1/8
4.0	5.2	1.25	0-280	W10H	⊕	Open		3070-5110	11	12	5 1/2	6 1/8	4 1/2
4.0	5.2	1.25	0-280	W10HM	⊕	Encl		3070-5111	14	17	6 1/2	9 1/2	5 1/2
5.0	6.5	1.56	0-280	W5G2M	⊕	Encl	Series	3030-5121	15	23	5 1/2	6 1/2	8 1/2
6.0	7.8	1.87	0-280	W5G2	⊕	Open	Series	3030-5120	14	15	4 1/2	4 1/8	8
8.0	10.4	2.50	0-280	W20H	⊕	Open		3100-5110	20	23	7 1/2	8 1/8	4 1/2
8.0	10.4	2.50	0-280	W20HM	⊕	Encl		3100-5111	23	28	8 1/2	11 1/8	5 1/2
8.5	11.0	2.64	0-280	W8G2	⊕	Open	Series	3038-5120	16	19	4 1/2	4 1/8	9 1/8
10.0	13.0	3.12	0-240	W8LG2	⊕	Open	Series 60 Hz only	3058-5120	17	19	4 1/2	4 1/8	9 1/8
10.0	13.0	3.12	0-280	W10G2	⊕	Open	Series	3060-5120	25	27	5 1/2	6 1/8	9 1/8
10.0	13.0	3.12	0-280	W10G2M	⊕	Encl	Series	3060-5121	29	34	7 1/2	9 1/8	9 1/2
12.0	15.6	3.74	0-280	W30H	⊕	Open		3130-5110	29	36	10	11 1/8	4 1/2
12.0	15.6	3.74	0-280	W30HM	⊕	Encl		3130-5111	36	45	11	14 1/8	5 1/2
16.0	20.8	4.99	0-280	W20HG2	⊕	Open	Parallel	1 3100-5120	41	46	7 1/2	8 1/8	9 1/8
16.0	20.8	4.99	0-280	W20HG2M	⊕	Encl	Parallel	1 3100-5121	45	54	9	12 1/8	9 1/2
20.0	26.0	6.24	0-280	W20G2	⊕	Open	Series	3090-5120	43	48	7 1/2	8 1/8	9 1/8
20.0	26.0	6.24	0-280	W20G2M	⊕	Encl	Series	3090-5121	48	56	9	12 1/8	9 1/2
20.0	31.0	7.45	0-280	W50HM	⊕	Encl		3160-5111	60	76	13 1/2	16 1/8	7 1/2
24.0	31.2	7.5	0-280	W30HG2	⊕	Open	Parallel	1 3130-5120	59	76	10	11 1/8	9 1/2
24.0	31.2	7.5	0-280	W30HG2M	⊕	Encl	Parallel	1 3130-5121	64	87	11 1/2	14 1/8	10 1/8
25.0	32.5	7.80	0-280	W50H	⊕	Open		3160-5110	53	60	12 1/2	13 1/8	6 1/2
28.0	32.0	7.7	0-280	W30G2M	⊕	Encl	Series	3120-5121	67	90	11 1/2	14 1/8	10 1/8
30.0	36.0	8.6	0-280	W30G2	⊕	Open	Series	3120-5120	61	80	10	11 1/8	9 1/2
36.0	46.8	11	0-280	W30HG3	⊕	Open	Parallel	3 3130-5130	90	107	10	11 1/8	20 1/2
36.0	46.8	11	0-280	W30HG3M	⊕	Encl	Parallel	3 3130-5131	97	120	11 1/2	14 1/8	14 1/8
40.0	62.0	14.9	0-280	W50HG2M	⊕	Encl	Parallel	1 3160-5121	126	165	13 1/2	17 1/8	14 1/8
50.0	65.0	15.6	0-280	W50HG2	⊕	Open	Parallel	1 3160-5120	116	153	12 1/2	13 1/2	14 1/2
60.0	93.0	22.3	0-280	W50HG3M	⊕	Encl	Parallel	3 3160-5131	183	230	13 1/2	17 1/8	21 1/8
75.0	97.5	23.4	0-280	W50HG3	⊕	Open	Parallel	3 3160-5130	167	214	12 1/2	13 1/2	20 1/2
80.0	124.0	29.8	0-280	W50HG4BBM	⊕	Encl	Parallel	4 3160-5241	255	328	13 1/2	17 1/8	27 1/8
100.0	130.0	31.2	0-280	W50HG4BB	⊕	Open	Parallel	4 3160-5240	230	300	12 1/2	13 1/2	27 1/2
120.0	186.0	44.6	0-280	W50HG6BBM	⊕	Encl	Parallel	6 3160-5261	385	458	13 1/2	17 1/8	40 1/8
150.0	195.0	46.8	0-280	W50HG6BB	⊕	Open	Parallel	6 3160-5260	355	428	12 1/2	13 1/2	40

Single-phase, 480-volt input, 50-60Hz

2.0	2.6	1.24	0-560	W5HG2	⊕	Open	Series	3040-5120	13	15	4 1/2	4 1/8	8
2.0	2.6	1.24	0-560	W5HG2M	⊕	Encl	Series	3040-5121	15	23	5 1/2	6 1/8	8 1/2
4.0	5.2	2.5	0-560	W10HG2	⊕	Open	Series	3070-5120	24	27	5 1/2	6 1/8	9 1/8
4.0	5.2	2.5	0-560	W10HG2M	⊕	Encl	Series	3070-5121	29	33	7 1/2	9 1/8	9 1/2
8.0	10.4	5.0	0-560	W20HG2	⊕	Open	Series	3100-5120	41	46	7 1/2	8 1/8	9 1/8
8.0	10.4	5.0	0-560	W20HG2M	⊕	Encl	Series	3100-5121	45	54	9	12 1/8	9 1/2
12.0	15.6	7.48	0-560	W30HG2	⊕	Open	Series	3130-5120	59	76	10	11 1/8	9 1/2
12.0	15.6	7.48	0-560	W30HG2M	⊕	Encl	Series	3130-5121	64	87	11 1/2	14 1/8	10 1/8
20.0	31.0	14.9	0-560	W50HG2M	⊕	Encl	Series	3160-5121	128	165	13 1/2	17 1/8	14 1/8
25.0	32.5	15.6	0-560	W50HG2	⊕	Open	Series	3160-5120	116	153	12 1/2	13 1/2	14 1/2
40.0	62.0	29.8	0-560	W50HG4BBM	⊕	Encl	Parallel	2 3160-5241	255	328	13 1/2	17 1/8	27 1/8
50.0	65.0	31.2	0-560	W50HG4BB	⊕	Open	Parallel	2 3160-5240	230	300	12 1/2	13 1/2	27 1/2
60.0	91.0	44.7	0-560	W50HG6BBM	⊕	Encl	Parallel	6 3160-5261	355	430	13 1/2	17 1/8	40 1/8
75.0	97.5	46.8	0-560	W50HG6BB	⊕	Open	Parallel	6 3160-5260	355	428	12 1/2	13 1/2	40

⊕ Federal stock numbers are listed before the Index.

How to Select a Three-Phase Variac

As discussed in an earlier paragraph, selecting the proper Variac® autotransformer depends on your first knowing the conditions imposed by the power line (frequency, voltage, and phase) and by the load (expressed in current or power).

To determine the needed rating for a three-phase Variac assembly, look at the individual units in the assembly and the line voltage and currents that will be imposed upon them. If the voltages and currents are within rating for the individual units, the assembly will do the job.

To control three-phase power, Variac autotransformers can be connected in either a wye configuration, which requires three units ganged (or 6, 9, or 12 for added capacity), or in an open-delta configuration, which requires two units ganged (or 4, 6, etc).

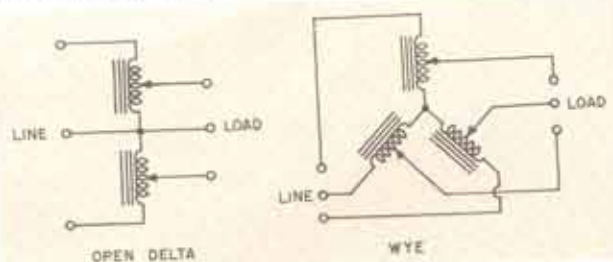

Consider the simplest cases where a single Variac unit is used in each arm. In the **wye** configuration, the full line-to-line voltage is not imposed on each unit, rather it is $1/\sqrt{3}$ or about 58% of the voltage. Thus a 240-volt line will impose about 138 volts on each unit. However, each unit supplies the full line current to the load through its brush. In the **open delta**, the input to each unit is the full voltage from the line and each unit must supply the full line current.

Line voltage Three-phase Variac assemblies are specified for the more common 208-volt, 240-volt, and 480-volt lines. The **open delta** Variac configuration is limited to the 208- and 240-volt applications and must use the Variac units with a basic rating of 240 volts; the over-

voltage connection can be used. If the **wye** is used, the three common line voltages will impose 120, 138, and 277 volts respectively on the individual units in the assembly. So, for 208-volt lines, the Variac units rated for 120 volts can be employed, and the overvoltage connection used, if desired. For 240-volt lines, either 120-volt units can be used (restricted to the line-voltage connection) or 240-volt units can be used (overvoltage permitted). For 480-volt lines, 240-volt units are usable but restricted to line-voltage connection.

Load current The current rating of the individual Variac autotransformers in the ganged assemblies is the same as the maximum line current to the load. Thus, each leg of the wye or open delta can be selected as though it were a single-phase unit. Each leg can consist of as many units paralleled (with required chokes) as is necessary to handle the current. Standard assemblies are offered with up to 12 ganged-units (a wye with four paralleled units in each leg), and even larger ones can be supplied on special order.

Load power An aid to computing the load power from the voltage and current ratings of individual components of a three-phase load, and the reverse calculations, is given in "Get more out of your Variac," later in this section. However, the kVA ratings of the three-phase Variac autotransformers require an explanation. As with single-phase units, three-phase kVA rating is the product of the maximum current and the line voltage (multiplied by $\sqrt{3}$).^{*} It should not be used in selecting a Variac when the overvoltage connection is employed, when nonlinear loads are used, or when the phase loads may be unbalanced. In those cases, the separate line currents should be calculated and compared against the rated current of the Variac.

Line frequency The selection of a W- or M-series Variac based on line frequency will be governed by the same considerations discussed earlier. Three-phase models for operation at 350 Hz and above are listed later, under 400-Hz operation.

* $\sqrt{3}$ single-phase units, each with $1/\sqrt{3}$ the line voltage.



Three-phase, 208-volt input, 60-Hz only

Output					Description								
Rated Current Amperes	Max Current Amperes	kVA	Max Output Voltage Range	Type	Mounting	Connection	W50-P1 Chokes Req'd for par- allel operation	Catalog Number	Net Weight lb	Shipping Wt lb	Outline Dimensions (Inches)		
											W	H	D
7.1	9.2	3.31	0-208	W5LG3M	Encl	Wye		3050-5131	22	32	5 1/4	6 1/4	12 1/4
8.5	11.0	3.95	0-208	W5LG3	Open	Wye		3050-5130	20	23	4 1/2	4 1/4	12 1/4
10.0	13.0	4.68	0-208	W8LG3	Open	Wye		3058-5130	25	27	4 1/2	4 1/4	13 3/4

⊕ Federal stock numbers are listed before the Index.

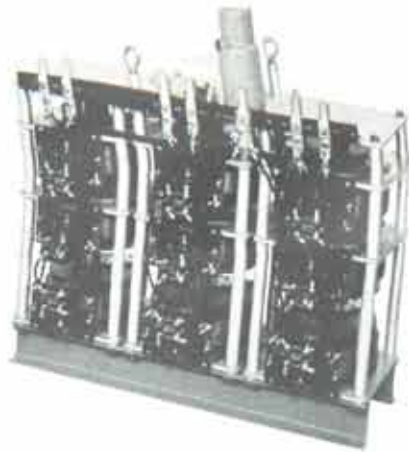

W50G9



W20G3

Three-phase, 208-240-volt input, 50-60 Hz Overvoltage may be used on open delta connection or 208-volt input.

Output				Description									
Rated Current Amperes	Max Current Amperes	kVA	Max Output Voltage Range	Type	Mounting	Connection	W50-P1 Chokes Req'd for parallel operation	Catalog Number	Net Weight lb	Shipping Wt lb	Outline Dimensions (inches)		
											W	H	D
2.0	2.6	1.08	0-280	W5HG2	Open	Open Delta		3040-5120	13	15	4 1/2	4 3/4	8
2.0	2.6	1.08	0-280	W5HG2M	Encl	Open Delta		3040-5121	15	23	5 1/2	6 1/2	8 1/2
2.0	2.6	1.08	0-240	W2G3M	Encl	Wye		3010-5131	12	21	4 1/2	5 1/2	12 1/2
2.4	3.1	1.29	0-240	W2G3	Open	Wye		3010-5130	11	13	3 1/2	3 3/4	12
4.0	5.2	2.16	0-280	W10HG2	Open	Open Delta		3070-5120	24	27	5 1/2	6 1/4	9 1/2
4.0	5.2	2.16	0-280	W10HG2M	Encl	Open Delta		3070-5121	29	33	7 1/2	9 1/4	9 1/2
5.0	6.5	2.70	0-240	W5G3M	Open	Wye		3030-5131	22	32	5 1/2	6 3/4	12 1/2
6.0	7.8	3.24	0-240	W5G3	Encl	Wye		3030-5130	20	22	4 1/2	4 3/4	12 1/2
8.0	10.4	4.32	0-280	W20HG2	Open	Open Delta		3100-5120	41	46	7 1/2	8 1/4	9 1/2
8.0	10.4	4.32	0-280	W20HG2M	Encl	Open Delta		3100-5121	45	54	9	12 1/4	9 1/2
8.5	11.0	4.57	0-240	W8G3	Open	Wye		3038-5130	25	27	4 1/2	4 3/4	13 1/4
10.0	13.0	5.40	0-240	W10G3	Open	Wye		3060-5130	37	40	5 1/2	6 1/4	14
10.0	13.0	5.40	0-240	W10G3M	Encl	Wye		3060-5131	43	47	7 1/2	9 1/4	14 3/4
12.0	15.6	6.48	0-280	W30HG2	Open	Open Delta		3130-5120	59	76	10	11 1/4	9 1/2
12.0	15.6	6.48	0-280	W30HG2M	Encl	Open Delta		3130-5121	64	87	11 3/4	14 1/4	10 1/2
20.0	26.0	10.8	0-240	W20G3	Open	Wye		3090-5130	65	71	7 1/2	8 1/4	13 1/2
20.0	26.0	10.8	0-240	W20G3M	Encl	Wye		3090-5131	71	82	9	12 1/4	13 3/4
20.0	31.0	12.9	0-280	W50HG2M	Encl	Open Delta		3160-5121	126	165	13 3/4	17 1/4	14 1/2
25.0	32.5	13.5	0-280	W50HG2	Open	Open Delta		3160-5120	116	153	12 1/2	13 1/2	14 1/2
28.0	32.0	13.3	0-240	W30G3M	Encl	Wye		3060-5131	99	125	11 1/2	14 1/4	14 1/2
30.0	36.0	15.0	0-240	W30G3	Open	Wye		3120-5130	93	113	12 1/2	13 1/2	20 1/2
40.0	45.0	18.7	0-240	W50G3M	Encl	Wye		3150-5131	179	221	13 3/4	17 1/4	21 1/2
50.0	50.0	20.8	0-240	W50G3	Open	Wye		3150-5130	163	206	12 1/2	13 1/2	20 1/2
40.0	62.0	25.8	0-280	W50HG4BBM	Encl	Open Delta	2	3160-5241	255	328	13 3/4	17 1/4	27 1/2
50.0	65.0	27.0	0-280	W50HG4BB	Open	Open Delta	2	3160-5240	230	300	12 1/2	13 1/2	27 1/2
80.0	90.0	37.4	0-240	W50G6BBM	Encl	Wye	3	3150-5261	355	430	13 3/4	17 1/4	40 1/2
100.0	100.0	41.6	0-240	W50G6BB	Open	Wye	3	3150-5260	325	400	12 1/2	13 1/2	40
*150.0	150.0	62.4	0-240	W50G9BB	Open	Wye (chokes included)			600	720	39	35	17
*200.0	200.0	83.2	0-240	W50G12BB	Open	Wye (chokes included)			760	880	39	41	17

Three-phase, 480-volt input, 50-60 Hz (Overvoltage connection not recommended)

2.0	2.6	2.16	0-480	W5HG3	Open	Wye		3040-5130	20	22	4 1/2	4 3/4	12 1/2
2.0	2.6	2.16	0-480	W5HG3M	Encl	Wye		3040-5131	22	31	5 1/2	6 1/2	12 1/2
4.0	5.2	4.32	0-480	W10HG3	Open	Wye		3070-5130	36	39	5 1/2	6 1/4	14
4.0	5.2	4.32	0-480	W10HG3M	Encl	Wye		3070-5131	42	46	7 1/2	9 1/4	14 1/2
8.0	10.4	8.65	0-480	W20HG3	Open	Wye		3100-5130	61	68	7 1/2	8 1/4	13 1/2
8.0	10.4	8.65	0-480	W20HG3M	Encl	Wye		3100-5131	67	79	9	12 1/4	13 3/4
12.0	15.6	13.0	0-480	W30HG3	Open	Wye		3130-5130	90	107	12 1/2	13 1/2	20 1/2
12.0	15.6	13.0	0-480	W30HG3M	Encl	Wye		3130-5131	97	120	11 1/2	14 1/4	14 1/2
20.0	31.0	25.8	0-480	W50HG3M	Encl	Wye		3160-5111	183	230	13 3/4	17 1/4	21 1/2
25.0	32.5	27.0	0-480	W50HG3	Open	Wye		3160-5130	167	214	12 1/2	13 1/2	20 1/2
40.0	62.0	51.5	0-480	W50HG6BBM	Encl	Wye	3	3160-5261	385	458	13 3/4	17 1/4	40 1/2
50.0	65.0	54.0	0-480	W50HG6BB	Open	Wye	3	3160-5260	355	428	12 1/2	13 1/2	40
*75.0	97.5	81.0	0-480	W50HG9BB	Open	Wye (chokes included)			610	730	39	35	17
*100.0	130	108.0	0-480	W50HG12BB	Open	Wye (chokes included)			806	926	39	41	17

* Motor drive only.

Three-phase, 560-volt input, 50-60 Hz available on request:

* Federal stock numbers are listed before the Index.



M20

400-Hz Operation

- small, light, excellent regulation
- high- and low-temperature lubrication
- iridite-treated aluminum parts
- fungicidal treatment of all phenolic parts
- special nickel-plated brush holders

The M-series models are designed for use at frequencies between 350 and 1200 Hz. They are electrically the high-frequency equivalents of the standard W series but are much smaller and lighter than the 60-Hz models. At 400 Hz, the regulation obtained with the M-series is considerably better than with the 60-Hz models.

All M-series units conform to most military specifications for shock, vibration, salt spray, tropicalization, altitude, humidity, and temperature. See General Specifications section for further information regarding military environmental specifications. Operation of the M-series models is possible at 60 Hz if the input is limited to 60 volts. The output current remains the same and the output voltage range is 0 to 70 volts.

Single-phase, 120-volt input, 400-Hz

Output				Description								
Rated Current Amperes	Max Current Amperes	kVA	Max Output Voltage Range	Type	Mounting	Connection	Catalog Number	Net Weight lb	Shipping Wt. lb	Outline Dimensions (inches)		
										W	H	D
2.4	3.1	0.37	0-140	M2	⊕	Open	3410-5110	2	3	3½	3¾	2¾
6.0	7.8	0.94	0-140	M5	⊕	Open	3430-5110	3	4	4½	4¾	2¾
10.0	13.0	1.56	0-140	M10	⊕	Open	3460-5110	6	8	5½	6¾	3¾
20.0	26.0	3.12	0-140	M20	⊕	Open	3490-5110	13	15	7½	8¾	3¾

Three-phase, 120-volt input, 400-Hz

2.4	3.1	0.65	0-140	M2G2	⊕	Open	Open Delta	3410-5120	4	5	3½	3¾	5½
6.0	7.8	1.62	0-140	M5G2	⊕	Open	Open Delta	3430-5120	7	8	4½	4¾	5½
10.0	13.0	2.7	0-140	M10G2	⊕	Open	Open Delta	3460-5120	12	16	6½	6¾	6¾
20.0	26.0	5.4	0-140	M20G2	⊕	Open	Open Delta	3490-5120	26	30	7	8¾	7¾

Three-phase, 120-208-240-volt, 400-Hz

2.4	3.1	1.30	0-240*	M2G3	⊕	Open	Wye	3410-5130	5	7	3½	3¾	8½
6.0	7.8	3.24	0-240*	M5G3	⊕	Open	Wye	3430-5130	10	12	4½	4¾	8½
10.0	13.0	5.4	0-240*	M10G3	⊕	Open	Wye	3460-5130	19	23	5½	6¾	10½
20.0	26.0	10.8	0-240*	M20G3	⊕	Open	Wye	3490-5130	38	43	7½	8¾	10½

* 17% overvoltage connection is permitted on 120/208, three-phase lines.

⊕ Federal stock numbers are listed before the Index.



W8MT3VM



W8MT3

Portable Variac® Autotransformers

Portable, metered, cased units are available in twenty models for use in the laboratory and on the test bench. Each consists of a Variac autotransformer and an overload protector. Some models have a voltmeter, ammeter, and wattmeter in different configurations.

Adequate meter shielding is provided to reduce stray fields sufficiently to give over-all meter accuracy of 3% of full scale (5% of full scale for the powerful W20HMT3A).

The output circuit is protected by either a Klixon* thermal overload breaker, resettable from the panel, or by easily accessible and replaceable fuses.

A double-pole on-off switch disconnects both sides of the line. Where dual-range meters are used, make-before-break range switches permit switching under load. All have convenient carrying handles. Some models come in both 2- and 3-wire versions.

* Registered trademark of Texas Instruments Inc.

Single-phase, 120-volt input, 50-60 Hz

Output			Type	Meter Ranges (full scale)			2- or 3-wire cord and receptacle	Catalog Number	Net Weight lb	Shipping Wt lb	Outline Dimensions (inches)		
Rated Current Amperes	Max Current Amperes	Max Output Voltage Range		Amperes	Watts	Volts					W	H	D
5.0	—	0-140	W5MT	—	—	—	2	3030-5118	8	15	4 $\frac{1}{2}$	6 $\frac{1}{2}$	4 $\frac{1}{2}$ †
5.0	—	0-140	W5MT3	—	—	—	3	3030-5119	8	15	4 $\frac{1}{2}$	6 $\frac{1}{2}$	4 $\frac{1}{2}$ †
5.0	—	0-140	W5MT3VM	—	—	150	3	3030-5015	8	19	4 $\frac{1}{2}$	6 $\frac{1}{2}$	4 $\frac{1}{2}$
5.0	—	0-140	W5MT3A	1/5	—	150	3	3030-5012	11	19	6 $\frac{1}{2}$	9 $\frac{1}{2}$	5 $\frac{1}{2}$
5.0	—	0-140	W5MT3W	—	150/750	150	3	3030-5013	12	19	6 $\frac{1}{2}$	9 $\frac{1}{2}$	5 $\frac{1}{2}$
5.0	—	0-140	W5MT3AW	1/5	150/750	150	3	3030-5014	12	21	11 $\frac{1}{2}$	8 $\frac{1}{2}$	5 $\frac{1}{2}$
7.1	—	0-120	W5LMT3†	—	—	—	3	3050-5119	8	18	4 $\frac{1}{2}$	6 $\frac{1}{2}$	4 $\frac{1}{2}$
10.0	—	0-140	W8MT3	—	—	—	3	3038-5119	10	16	5 $\frac{1}{2}$	7	6 $\frac{1}{2}$
10.0	—	0-140	W8MT3VM	—	—	150	3	3038-5015	10	16	5 $\frac{1}{2}$	7	6 $\frac{1}{2}$
10.0	—	0-140	W10MT	—	—	—	2	3060-5118	16	24	6 $\frac{1}{2}$	9 $\frac{1}{2}$	5 $\frac{1}{2}$ †
10.0	—	0-140	W10MT3	—	—	—	3	3060-5119	16	24	6 $\frac{1}{2}$	9 $\frac{1}{2}$	5 $\frac{1}{2}$ †
10.0	—	0-140	W10MT3A	2/10	—	150	3	3060-5012	18	30	8 $\frac{1}{2}$	11 $\frac{1}{4}$	5 $\frac{1}{2}$
10.0	—	0-140	W10MT3W	—	300/1500	150	3	3060-5013	18	30	8 $\frac{1}{2}$	11 $\frac{1}{4}$	5 $\frac{1}{2}$
18.0	—	0-140	W20MT3A	20	—	150	3	3090-5012	27	34	8 $\frac{1}{2}$	11 $\frac{1}{4}$	5 $\frac{1}{2}$
18.0	—	0-140	W20MT3	—	—	—	3	3090-5119	20	23	8 $\frac{1}{2}$	11 $\frac{1}{4}$	5 $\frac{1}{2}$ †

† 60 Hz only

Single-phase, 240-volt input, 50-60 Hz

2.0	—	0-280	W5HMT	—	—	—	2	3040-5118	8	15	4 $\frac{1}{2}$	6 $\frac{1}{2}$	4 $\frac{1}{2}$ †
4.0	—	0-280	W10HMT	—	—	—	2	3070-5118	15	24	6 $\frac{1}{2}$	9 $\frac{1}{2}$	5 $\frac{1}{2}$
4.0	—	0-280	W10HMT3	—	—	—	3	3070-5119	15	24	6 $\frac{1}{2}$	9 $\frac{1}{2}$	5 $\frac{1}{2}$
8.0	—	0-280	W20HMT3	—	—	—	3	3100-5119	27	35	8 $\frac{1}{2}$	11 $\frac{1}{4}$	5 $\frac{1}{2}$ †
8.0	—	0-280	W20HMT3A	10	—	300	3	3100-5012	25	31	8 $\frac{1}{2}$	11 $\frac{1}{4}$	5 $\frac{1}{2}$

Types MT and MT3 have overvoltage connections and corresponding dial scales, but can be supplied on special order with line-voltage connections and dial scales.

* Listed under Re-examination Service of Underwriters' Laboratory.

† Approved by Canadian Standards Association.

⊕ Federal stock numbers are listed before the Index.

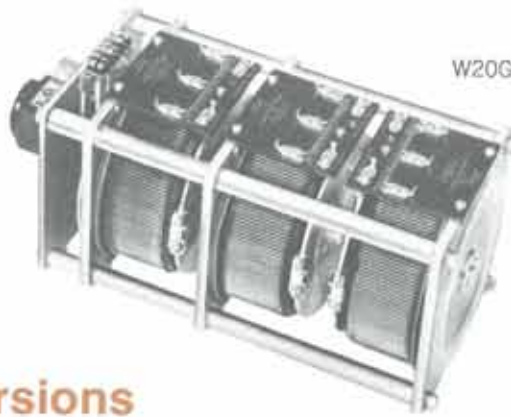

W20G3D8CK

Motor-Drive Versions

ORDERING INFORMATION

From table: yes = available from stock
so = available on special order

Establishing correct type number:

1. Select basic Variac type number; e.g., W5G2 (a 2-gang W5-series Variac)
2. Select time desired for full 320° traverse and insert time in "D-CK"
3. Arrange in following order:
W5G2D8CK (a 2-gang W5-series Variac with motor drive, 8-second traverse)
4. If fully enclosed case is desired, add "M", e.g., W5G2D8CKM.

Dimensions: Width and height are same as for component Variac. Depth is approx 6 inches greater than that of equivalent manually operated model.

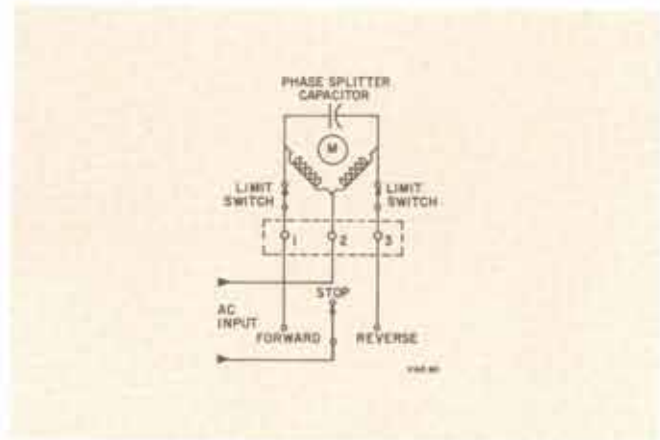

Schematic diagram of motor circuit

Seconds for full 320° Traverse*	Seconds for full 320° Traverse*							Shipping Weight (lb)		Seconds for full 320° Traverse*	Seconds for full 320° Traverse*							Shipping Weight (lb)	
	2	4	8	16	32	64	128	Cased	Uncased		2	4	8	16	32	64	128	Cased	Uncased
M2	yes	yes	yes	yes	yes	yes	...	9	...	W10	yes	yes	yes	yes	yes	yes	yes	23	30
M2G2	yes	yes	yes	yes	yes	yes	...	11	...	W10G2	so	so	yes	yes	yes	yes	yes	35	43
M2G3	...	yes	yes	yes	yes	yes	...	14	...	W10G3	so	so	yes	yes	yes	yes	yes	47	56
M5	yes	yes	yes	yes	yes	yes	...	14	...	W10H	yes	yes	yes	yes	yes	yes	yes	23	30
M5G2	yes	yes	yes	yes	yes	yes	...	16	...	W10HG2	so	yes	yes	yes	yes	yes	yes	35	43
M5G3	...	yes	yes	yes	yes	yes	...	19	...	W10HG3	so	so	yes	yes	yes	yes	yes	47	56
M10	yes	yes	yes	yes	yes	yes	yes	16	...	W20	so	yes	yes	yes	yes	yes	yes	35	50
M10G2	so	yes	yes	yes	yes	yes	yes	22	...	W20G2	so	so	yes	yes	yes	yes	yes	54	71
M10G3	so	so	yes	yes	yes	yes	yes	29	...	W20G3	so	so	yes	yes	yes	yes	yes	78	97
M20	...	yes	yes	yes	yes	yes	yes	27	...	W20H	so	yes	yes	yes	yes	yes	yes	35	47
M20G2	so	so	yes	yes	yes	yes	yes	47	...	W20HG2	so	so	yes	yes	yes	yes	yes	54	69
M20G3	so	so	yes	yes	yes	yes	yes	58	...	W20HG3	so	so	yes	yes	yes	yes	yes	77	93
W2	yes	yes	yes	yes	yes	yes	...	13	15	W30	so	yes	yes	yes	yes	yes	yes	57	79
W2G2	yes	yes	yes	yes	yes	yes	...	15	17	W30G2	...	so	so	yes	yes	yes	yes	89	98
W2G3	...	yes	yes	yes	yes	yes	...	17	20	W30G3	so	so	yes	yes	yes	120	120
W5	yes	yes	yes	yes	yes	yes	...	17	20	W30H	so	yes	yes	yes	yes	yes	yes	55	78
W5G2	yes	yes	yes	yes	yes	yes	...	23	26	W30HG2	...	so	so	yes	yes	yes	yes	88	98
W5G3	...	yes	yes	yes	yes	yes	...	33	39	W30HG3	so	so	yes	yes	yes	120	120
W5H	yes	yes	yes	yes	yes	yes	...	18	20	W50	...	so	so	yes	yes	yes	yes	95	125
W5HG2	yes	yes	yes	yes	yes	yes	...	25	28	W50G2	so	so	yes	yes	yes	162	194
W5HG3	...	yes	yes	yes	yes	yes	...	34	38	W50G3	so	so	yes	yes	yes	220	242
W5L	yes	yes	yes	yes	yes	yes	...	17	20	W50G4	so	so	so	so	yes	295	330
W5LG2	yes	yes	yes	yes	yes	yes	...	24	29	W50G6	so	so	so	so	yes	411	454
W5LG3	...	yes	yes	yes	yes	yes	...	27	32	W50G9	yes
W8	yes	yes	yes	yes	yes	yes	...	19	...	W50G12	yes
W8G2	yes	yes	yes	yes	yes	yes	...	28	...	W50H	...	so	so	yes	yes	yes	yes	100	130
W8G3	...	yes	yes	yes	yes	yes	...	37	...	W50HG2	so	so	yes	yes	yes	167	201
W8L	yes	yes	yes	yes	yes	yes	...	19	...	W50HG3	so	so	yes	yes	yes	222	246
W8LG2	yes	yes	yes	yes	yes	yes	...	28	...	W50HG4	so	so	so	so	yes	302	334
W8LG3	...	yes	yes	yes	yes	yes	...	37	...	W50HG6	so	so	so	so	yes	480	526
										W50HG9	yes
										W50HG12	yes

* Motor times given for 60-Hz operation. Add 20% more time for 50-Hz operation.

Variac® autotransformer – Type W8

Basic data for single section:	W8	W8L
Input	120 V, 50 to 60 Hz	120 V, 60 Hz
Output as % of input	0 to 117%	0 to 100%
Rated Current	8.5 A	10 A
Maximum Current	11 A	13 A
No-Load Loss at 60 Hz	12 W	12 W
Number of Turns	236	184
DC Resistance of Winding	1 Ω	0.5 Ω
Drive Torque (ounce-inches)	10 to 20	10 to 20
Replacement Brush	VB-3	VB-3

Dimensions Types W8 and W8L

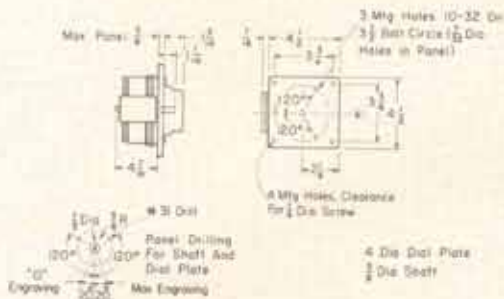

Dimensions Ganged
Types W8G2, W8G3, W8LG2,
and W8LG3

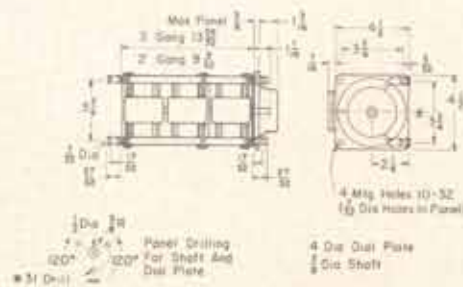

Variac® autotransformer – Type W10

Basic data for single section:	W10	W10H
Input	120 V, 50 to 60 Hz	240 V, 50 to 60 Hz
Output as % of Input	0 to 117%	0 to 117%
Rated Current	10 A	4 A
Maximum Current	13 A	5.2 A
No-Load Loss at 60 Hz	17 W	17 W
Number of Turns	212	430
DC Resistance of Winding	0.58 Ω	4.85 Ω
Drive Torque (ounce-inches)	15 to 30	15 to 30
Replacement Brush	VBT-10	VBT-11

Dimensions Types W10, W10M,
W10MT, W10MT3, W10H, W10HM,
W10HMT, and W10HMT3.

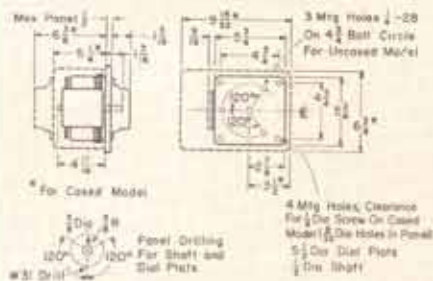

Dimensions Ganged Uncased
Types W10G2, W10G3, W10HG2,
and W10HG3

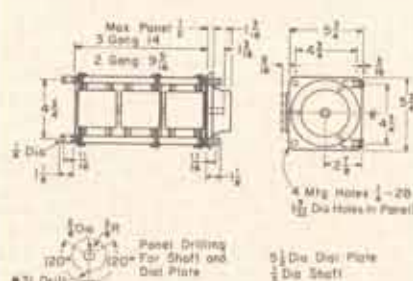

Dimensions Cased Types W10G2M,
W10G3M, W10HG2M, and
W10HG3M

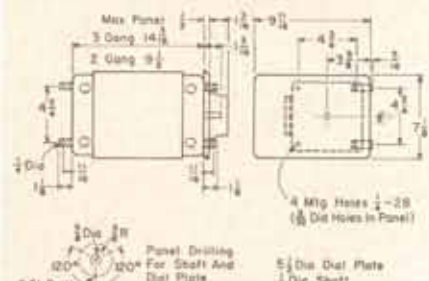

Variac® autotransformer – Type W20

Basic data for single section:	W20	W20H
Input	120 V, 50 to 60 Hz	240 V, 50 to 60 Hz
Output as % of Input	0 to 117%	0 to 117%
Rated Current	20 A	8 A
Maximum Current	26 A	10.4 A
No-Load Loss at 60 Hz	27 W	27 W
Number of Turns	169	339
DC Resistance of Winding	0.21 Ω	1.6 Ω
Drive Torque (ounce-inches)	45 to 90	45 to 90
Replacement Brush	VBT-8	VBT-12

Dimensions Types W20, W20M, W20MT3, W20H, W20HM and W20HMT3.

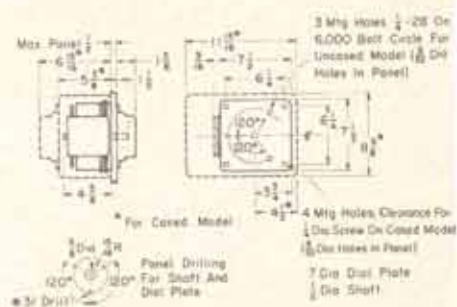

Dimensions Ganged Uncased Types W20G2, W20G3, W20HG2 and W20HG3

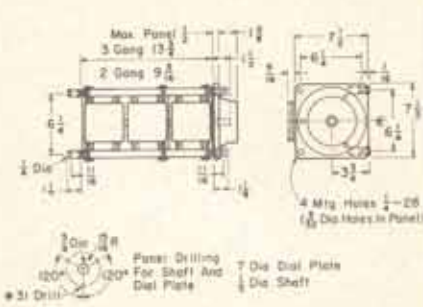

Dimensions Ganged Cased Types W20G2M, W20G3M, W20HG2M, and W20HG3M

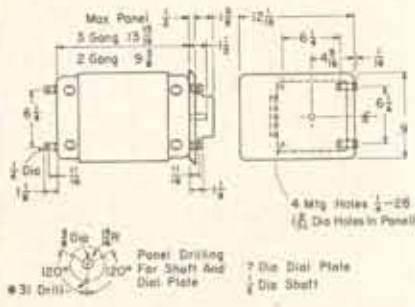

Variac® autotransformer – Type W30

Basic data for single section:	W30	W30H
Input	120 V, 50 to 60 Hz	240 V, 50 to 60 Hz
Output as % of Input	0 to 117%	0 to 117%
Rated Current	30 A	12 A
Maximum Current	36 A	15.6 A
No-Load Loss at 60 Hz	35 W	35 W
Number of Turns	184	367
DC Resistance of Winding	0.14 Ω	1.17 Ω
Drive Torque (ounce-inches)	50 to 100	50 to 100
Replacement Brush	VBT-13	VBT-14

Dimensions Types W30, W30M, W30H, and W30HM

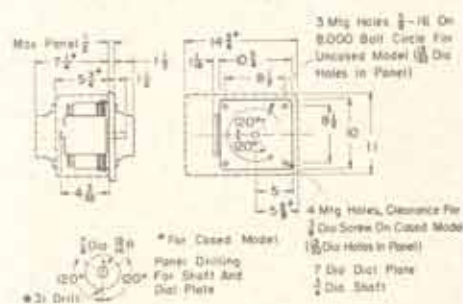

Dimensions Ganged Uncased Types W30G2, W30G3, W30G4, W30G6, W30HG2, W30HG3, W30HG4, and W30HG6

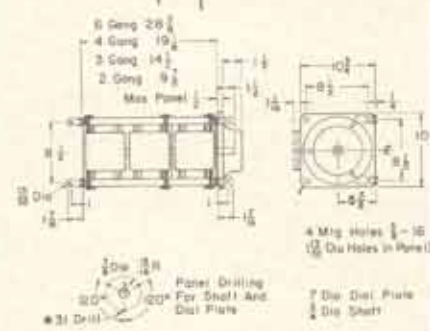

Dimensions Ganged Cased Types W30G2M, W30G3M, W30G4M, W30G6M, W30HG2M, W30HG3M, W30HG4M, and W30HG6M

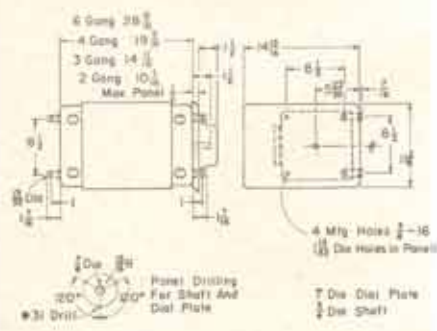

Variac® autotransformer – Type W50

Basic data for single section:	W50	W50H
Input	120 V, 50 to 60 Hz	240 V, 50 to 60 Hz
Output as % of Input	0 to 117%	0 to 117%
Rated Current	50 A	25 A
Maximum Current	50 A	32.5 A
No-Load Loss at 60 Hz	50 W	50 W
Number of Turns	186	294
DC Resistance of Winding	0.08 Ω	0.3 Ω
Drive Torque (ounce-inches)	150 to 300	150 to 300
Replacement Brush	VBT-6	VBT-7

Dimensions Types W50, W50M, W50H and W50HM

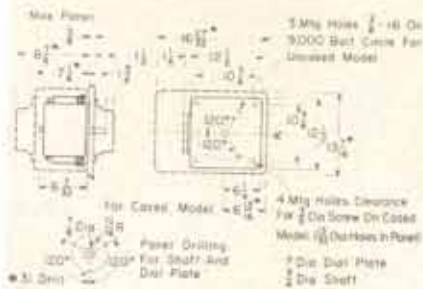

Dimensions Ganged Uncased Types W50G2, W50G3, W50G4, W50G6, W50HG2, W50HG3, W50HG4 and W50HG6

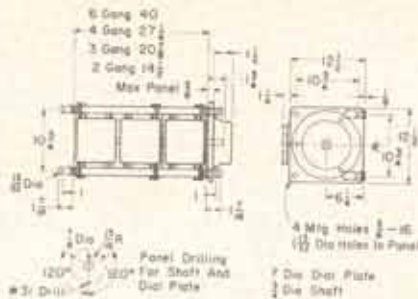

Dimensions Ganged Cased Types W50G2M, W50G3M, W50G4M, W50G6M, W50HG2M, W50HG3M, W50HG4M, and W50HG6M

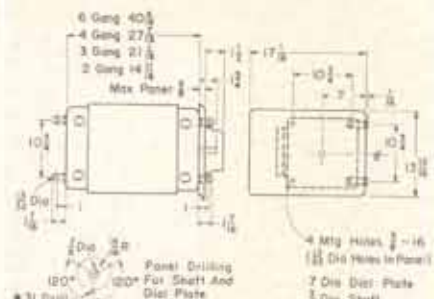

Variac® autotransformer – M-Series

Basic data for single section:	M2	M5	M10	M20
Input	120 V, 350 to 1200 Hz	120 V, 350 to 1200 Hz	120 V, 350 to 1200 Hz	120 V, 350 to 1200 Hz
Output as % of Input	0 to 117%	0 to 117%	0 to 117%	0 to 117%
Rated Current	2.4 A	6 A	10 A	20 A
Maximum Current	3.1 A	7.8 A	13 A	26 A
No-Load Loss at 400 Hz	3.5 W	9 W	17 W	27 W
Number of Turns	403	294	212	169
DC Resistance of Winding	6.25 Ω	1.2 Ω	0.36 Ω	0.15 Ω
Drive Torque (ounce-inches)	5 to 10	10 to 20	15 to 30	45 to 90
Replacement Brush	VB-1	VB-2	VBT-10	VBT-8

Dimensions Type M Variacs

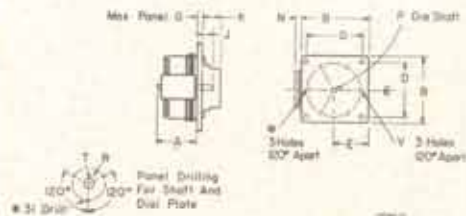

TYPE	A	B	D	E	G	J	K	N	P	R	T	V	W
M2	2 1/16"	3 1/4"	2 3/4"	1 3/8"	3/8"	1 1/8"	1"	3/16"	3/8"	3/8"	1/2"	10-32	—
M5	2 1/16"	4 1/2"	3 3/4"	2 1/4"	3/8"	1 1/8"	1 1/8"	3/16"	3/8"	3/8"	1/2"	—	10-32
M10	3 1/8"	5 3/8"	4 3/4"	2 3/8"	1/2"	1 1/8"	1 3/8"	3/16"	1/2"	3/8"	3/8"	—	1/4-28
M20	3 3/8"	7 1/2"	6 3/4"	3 3/4"	1/2"	1 1/2"	1 3/8"	3/16"	1/2"	3/8"	3/8"	—	1/4-28

Dimensions Type M Ganged Variacs

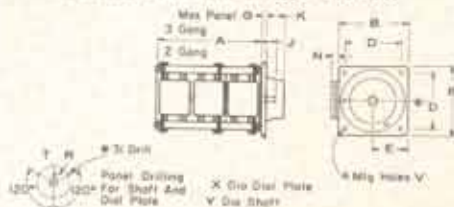

TYPE	A	B	D	E	G	J	K	N	R	T	V	X	Y
M2G2	5 1/16"	3 1/4"	2 3/4"	1 3/8"	3/8"	1 1/8"	1"	3/16"	3/8"	3/8"	1/2"	10-32	3"
M2G3	8 7/8"	3 1/4"	2 3/4"	1 3/8"	3/8"	1 1/8"	1"	3/16"	3/8"	3/8"	1/2"	10-32	3"
M5G2	5 1/16"	4 1/2"	3 3/4"	2 1/4"	3/8"	1 1/8"	1 1/8"	3/16"	3/8"	3/8"	1/2"	10-32	4"
M5G3	8 1/16"	4 1/2"	3 3/4"	2 1/4"	3/8"	1 1/8"	1 1/8"	3/16"	3/8"	3/8"	1/2"	10-32	4"
M10G2	6 1/16"	5 3/8"	4 3/4"	2 3/8"	1/2"	1 1/8"	1 3/8"	3/16"	3/8"	3/8"	1/2"	1/4-28	5 1/2"
M10G3	10 1/4"	5 3/8"	4 3/4"	2 3/8"	1/2"	1 1/8"	1 3/8"	3/16"	3/8"	3/8"	1/2"	1/4-28	5 1/2"
M20G2	7 1/8"	7 1/2"	6 3/4"	3 3/4"	1/2"	1 1/2"	1 3/8"	3/16"	3/8"	3/8"	1/2"	1/4-28	7"
M20G3	10 3/8"	7 1/2"	6 3/4"	3 3/4"	1/2"	1 1/2"	1 3/8"	3/16"	3/8"	3/8"	1/2"	1/4-28	7"

Get More Out of Your Variac

Careful overloading of a Variac® autotransformer can take advantage of many design trade-offs.

For example, the current ratings of all models assume trouble-free operation 24 hours a day, day after day. If a Variac is to be used only 2 hours or less per day, significantly more than rated current can be drawn for that short period. Figure 1 (general specifications) illustrates how up to 10 times the normal rating can be realized.

Also, if the load is frequently switched on and off, the duty ratio of that cycle can permit enough cooling during the off time to allow intentional overloading. A detailed discussion of this consideration appears below.

Finally, certain types of load permit the Variac rating to be increased, as reflected in Variac specifications.

Match the Variac to the load To enable the user to get the most out of a Variac autotransformer, General Radio specifies the current rating with two different numbers, rated current and maximum current. Briefly, remember that maximum current can be drawn from the autotransformer only when the output voltage is set near line voltage. Rated current, on the other hand, can be drawn at any setting of the Variac and is the only rating applicable when the overvoltage connection of the Variac is employed.

There are two basic categories of load (linear and non-linear) and the Variac cannot supply as much current at

a mid-range setting as it can near the extremes without overheating. In Figure 3, the sagging dashed line plots the reduction in the current capacity at mid-range. (With an output of 50% of line voltage, there is the greatest internal heating per ampere of output current.)

The straight black line shows the current that a well-behaved constant-impedance load will draw through the Variac as the voltage is decreased from maximum. Note that, even though maximum current is drawn at maximum voltage, the line stays well below the reduced capacity level at mid range. Typical of this kind of load is a heating element.

Unfortunately, all loads don't behave so well, incandescent lights in particular. They react to a decreasing voltage much as shown by the curved solid line. The current they draw drops very little even as the voltage is cut to 50% of maximum. If a load of this type is permitted to draw maximum current at maximum voltage, it will obviously exceed the Variac capacity at mid-range, causing overheating and reduced life. A Variac with larger current capacity must be chosen so the load will not exceed its rated current and thus remain within bounds at mid-range.

So, for many loads, the maximum current rating permits greater performance without risk, while for other common loads, the rated current specification is a neces-

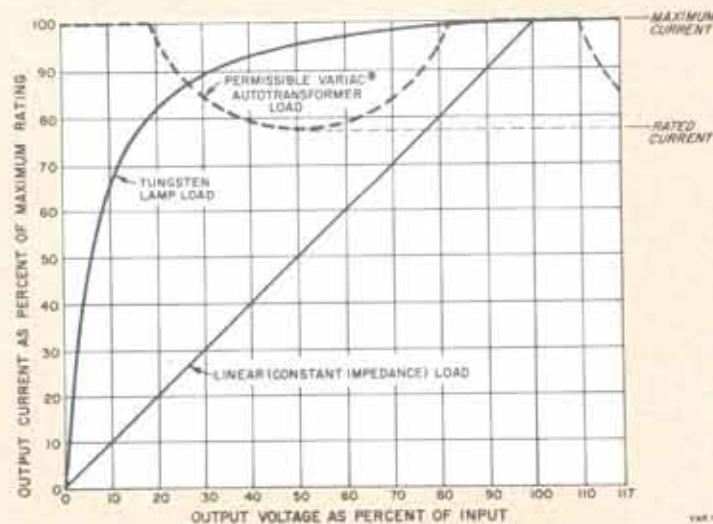

Figure 3. Typical load-current curves.

sary guard against overheating. To limit the specification to but one number would mean either unnecessary caution or undesirable risk; neither would permit full utilization of the Variac capability.

As to the limit on current when the overvoltage connection is used, the dashed line again sags very quickly out beyond the 100%-of-line-voltage point down to the rated-current value. Thus, at 117% of line, the most current that should be drawn is the rated value.

Effect of duty cycle When the load is continuously cycled on and off, the rating should be determined as follows. The duty-cycle is defined as the ratio of "off-plus-on" time to "on" time; the rated current can be multiplied by the square root of this ratio to obtain the allowable uprated current. The following examples will illustrate the calculation of permissible overloads for the Type W5 model, whose rated current is 6 amperes.

Example 1: The load is on for 15 seconds out of every 4 minutes (240 seconds).

$$\sqrt{\text{duty cycle}} = \sqrt{\frac{240}{15}} = 4$$

duty-cycle uprated current = 6 A × 4 = 24 A

From Figure 1 in the "General Specifications," a 15-second overload uprates the current by 500% so that

short-term overload current = 6 A × 5 = 30 A

Since the lower rating takes precedence, the 24-A limitation imposed by the duty ratio is the maximum current permissible. Note, on the overload curve of Figure 1, the lower curve must be used for models with built-in fuses.

Example 2: The load is on for 6 seconds out of each minute (60 seconds) over a duration of one-half hour.

$$\sqrt{\text{duty cycle}} = \sqrt{\frac{60}{6}} = 3.16$$

short-term overload for 30 minutes = 133%

from duty-cycle and 30-minute short-term overload considerations:

uprated current = 6 A × 3.16 × 1.33 = 24.6 A

short-term overload current = 6 A × 7.25 = 42.7 A

Since the lower rating takes precedence, the 24.6-A limitation imposed by the duty-cycle and 30-minute short-term overload is the maximum current permissible.

Three-phase load calculations If the three-phase-load unit is marked with rated line-voltage and current or load-power (kVA), you can easily select a Variac from the foregoing tables.

If, however, the ratings are known only for the individual three elements of the load, you must do some figuring to arrive at the values needed to use the selection tables.

Consider, for example, three heater elements, each rated at 1.4 kVA and 240 V, which are connected in a delta configuration as in Figure 4a. To deliver full power, they must be connected, through a Variac to provide control, to a 240-V line. The current each Variac must supply, I_{load} , is $\sqrt{3}$ times larger than the current in each element of a delta load:

$$I_{\text{load}} = \sqrt{3} \frac{1400 \text{ (VA)}}{240 \text{ V}} = 10.1 \text{ A}$$

In the table of 3-phase 240-V models, the first type listed with adequate "maximum current" rating is the W20HG2. It has two drawbacks, however: It cannot supply overvoltage output (since that means limiting the output to the "rated current" value), and it is not the most economical selection. The W8G3 Variac is considerably less expensive but cannot supply overvoltage either, for a different reason: It must be wired in a wye

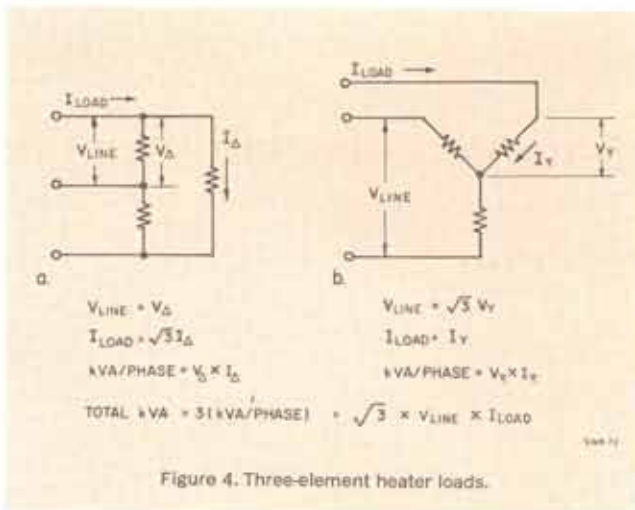

Figure 4. Three-element heater loads.

configuration in which the maximum voltage allowed, 140 V, will be applied to each unit in the assembly, thus preventing added voltage from being developed for the load. To get overvoltage capability, find, in the table, the next model that is wired in an open delta and has adequate "maximum current" rating: The W30HG2. A quick look at larger open-delta assemblies confirms that this is the least expensive choice.

Now consider three heater elements, each rated at 1.0 kVA and 120 V, which are connected in a wye as in Figure 4b. To deliver full power, each element must have 120 V applied. Since the line voltage across a wye is $\sqrt{3}$ times that across each arm, the needed line voltage is 208 V. Each arm will draw 1000 VA/120 V or 8.3 A from each Variac. From the specifications for three-phase units, select the W5LG3 as having adequate "maximum current" rating. However, the W5LG3 cannot supply overvoltage. If you want the overvoltage feature, you need a W8G3, based on its rated current.

Note that the configuration, open-delta or wye, of the load and the Variac do not have to match.

Voltage doubling In normal use, a Variac supplies an output of from 0 to line voltage (or slightly higher when the overvoltage connection is used). On the 240-V (H) models, a provision has been made to apply 120 V and get a 0-to-280-V output. This step-up of 2.33 is accomplished by the application of the high side of the line to either terminal 6 or 7 on the input of the Variac.

Because of the step-up action, the current in the "primary" of the autotransformer is approximately twice the output (brush) current rather than equal to the brush current as it is in the normal connection. Therefore the permissible load current is one half the standard rating for the unit. For example, the rated current for a W10H is 4 A for a 240-V input and 0-to-280-V output. But for a 120-V input and 0-to-240-V output, the rated current for the same unit is only 2 A.

W50-P1 Paralleling Choke

Many of the Variac® autotransformers listed on the preceding pages are indicated to require one or more Type W50-P1 Chokes. This unit is used when two or more autotransformer outputs are to be connected in parallel; it prevents the flow of potentially damaging currents from one unit to the other. Instructions for proper interconnecting are included with each unit.



Description	Catalog Number
W50-P1 Choke	3150-5016

Replacement Brushes

Occasionally, as a result of accident or excessive wear or current, it may be necessary to replace the autotransformer's carbon brush or brushes. They may be ordered from the table below.

Description	Catalog Number
VB-1 Brush, for M2, W2, W5H	3200-5901
VB-2 Brush, for M5, W5, W5L	3200-5900
VB-3 Brush, for W8, W8L	3200-5923
VBT-10 Brush, for M10, W10	3200-5910
VBT-11 Brush, for W10H	3200-5911
VBT-8 Brush Set, for M20, W20	3200-5908
VBT-12 Brush Set, for W20H	3200-5912
VBT-13 Brush Set, for W30	3200-5913
VBT-14 Brush Set, for W30H	3200-5914
VBT-6 Brush Set, for W50	3200-5906
VBT-7 Brush Set, for W50H	3200-5907

Minivolt* adjustable autotransformer

- pocket sized
- efficient
- ideal for low-voltage control



To save you weight and space, for low-voltage applications, we bring you the Minivolt* adjustable autotransformer. Like the larger members of the Variac® family, it provides smooth, wide-range control — from zero to full input voltage. Likewise, it provides the efficiency and minimal regulation (low source impedance) of a well-designed transformer — far superior to that obtainable with a rheostat of similar size.

Mounts in a single panel hole. The open construction is neat and functional. Three versions are offered; choose the one suited to your input voltage.

Note: This product is manufactured exclusively in Europe. A complete line of Variac® adjustable autotransformers (not listed in this catalog) is also manufactured there.

Description	Catalog Number
Minivolt* adjustable autotransformer	
LO-12, 12-volt	3230-5000
LO-24, 24-volt	3230-5001
LO-36, 36-volt	3230-5002

SPECIFICATIONS

Ratings:

Type	Output Voltage	Current	
		Rated	Max
LO-12	0 to 12 V	3.0	3.9 A
LO-24	0 to 24 V	1.2	1.5 A
LO-36	0 to 36 V	0.6	0.8 A

Frequency: 50-60 Hz.

Mechanical: Open construction, panel mounting. DIMENSIONS (AxBxC): 1.81x1.62x1.06 in. (46x41x27 mm). WEIGHT: 0.66 lb (0.3 kg) net.

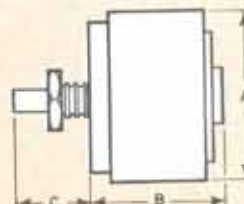

* A registered trademark owned by General Radio France, a subsidiary of General Radio Company.

⊕ Federal stock numbers are listed before the index.

General Lab Instruments

Signal Sources — Sine-wave and Pulse

Attenuators

Counters

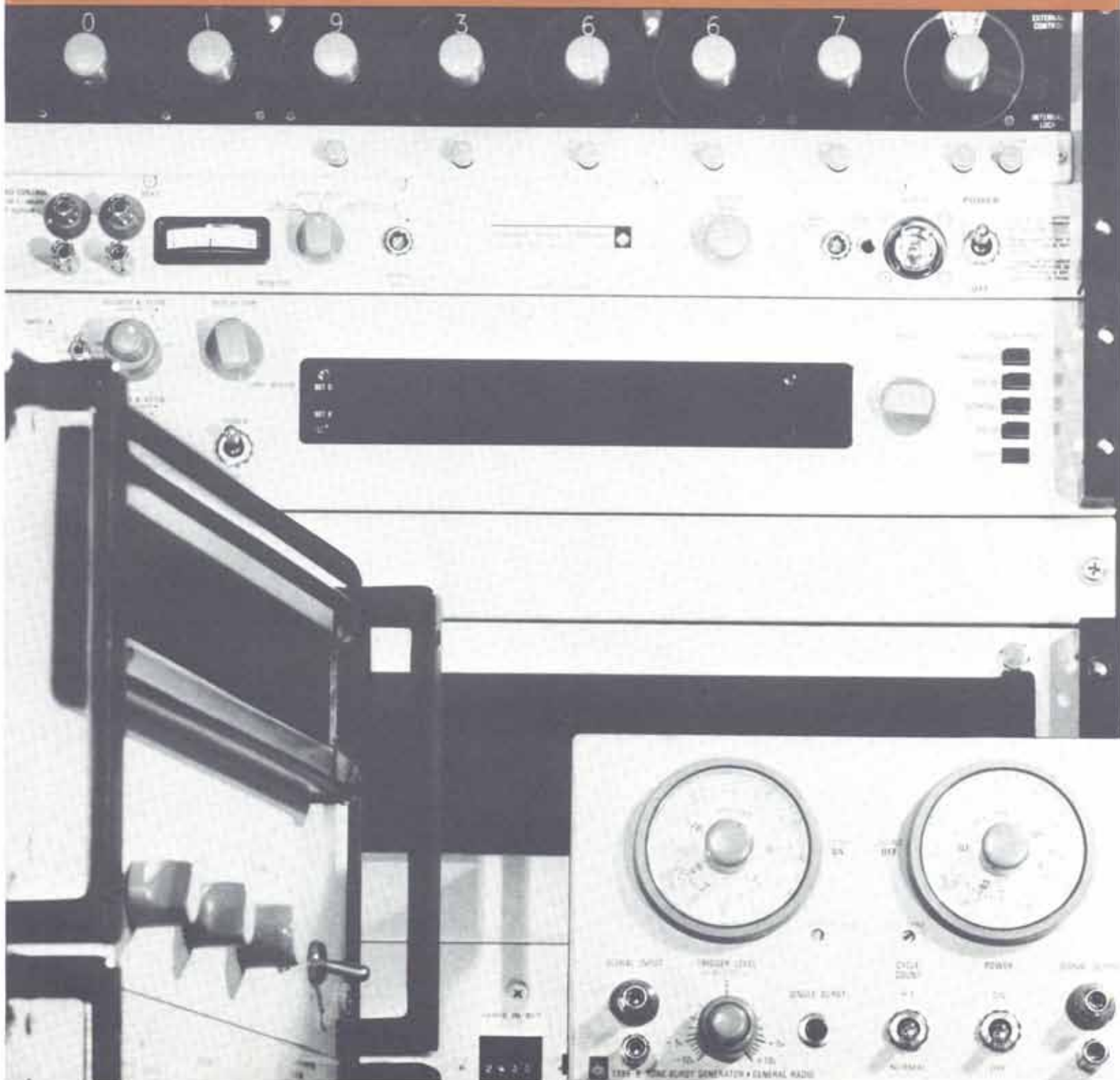

GR Signal Generators

- amplitude modulation, internal and external
- low incidental modulation
- high output
- precision output attenuator

For complete specifications, see pages 232 through 236.

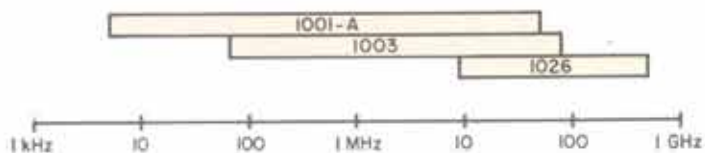

GR 1003

- 67 kHz to 80 MHz, $\pm 0.25\%$ accuracy
- 1-ppm typical stability
- auto-tuning to preset frequencies *
- sweep operation *
- manual and electrical Δf control
- internal crystal calibrator *
- output leveled to ± 1 dB



GR 1026

- 9.5 to 500 MHz, $\pm 0.5\%$ accuracy
- 50-ppm typical stability
- wide-band and pulse modulation
- manual and electrical Δf control
- internal crystal calibrator *
- output leveled to ± 0.5 dB



GR 1001-A

- 5 kHz to 50 MHz, $\pm 1\%$ accuracy
- 0.2% stability
- economical



* Features available as options.

GR Frequency Synthesizers

for wide frequency range, high resolution, precise frequency control, accuracy, stability, low noise, programmability, and sweep capability

For complete specifications see pages 219 through 227.

Type	Frequency Range	Features
------	-----------------	----------



1161	dc to 100 kHz	} up to 7 digits, modular programmable search/sweep economical
1162	dc to 1 MHz	
1163	30 Hz to 12 MHz	
1164	10 kHz to 70 MHz	



1165	10 kHz to 160 MHz	} up to 7 digits, 100-Hz steps
1168	10 kHz to 160 MHz	

Type	Frequency Range	Features
------	-----------------	----------



1165	10 kHz to 160 MHz	} sweep programmable 9 digits, 1-Hz steps
1061	10 kHz to 160 MHz	



1062	10 kHz to 500 MHz	} search/sweep programmable, 100-μs switching, phase-modulation, better than 80-dB spurious, up to 10-digits, 0.1-Hz steps
1061	10 kHz to 160 MHz	

Synthesizer Modules for 1161, 1162, 1163, and 1164 Synthesizers



1160-RDI-1B



1160-CAD-1

Sold only as replacements or to fill out partially equipped synthesizers.

1160-CAD-1 — Continuously Adjustable Decade Module

The 1160-CAD-1 Continuously Adjustable Decade module is available to add increased versatility and extended resolution. It can convert any step decade (and all to its right) to continuously adjustable operation at the push of a button. The module is complete and ready to plug into the decade station at the right-hand end of any of the synthesizers. **Net Weight:** 1¾ lb (0.8 kg).

1160-RDI — Programmable Step-Decade Modules

The 1160-RDI Digit-Insertion Units (remote or manual control) are offered to fill out partially complete synthesizers or convert manual instruments, partially or fully, to programmed operation. The modules are ready to plug in. A filter-plug at the rear can be cabled to a programmer for fast, automatic operation.

Four models The 1160-RDI-1B unit will operate in any station of any synthesizer up to the X1-MHz position from a 10-line command input. The 1163-RDI-4 operates in the X1-MHz position of an 1163 synthesizer, controlled from a 12-line input. The 1164-RDI-2 replaces the manual step-decade module in the X1-MHz position of an 1164-series synthesizer. The 1164-RDI-3 operates in the X10-MHz position in the 1164 model synthesizers with a 7-line command input for full programmability to 70 MHz. **Net Weight:** 1½ lb (0.7 kg).

Hook-up cable for RDI One 50-foot roll of cable of special, 12-conductor, shielded cable is furnished with each synthesizer containing an RDI unit but is not supplied with an individually purchased RDI. Additional 50-foot lengths can be ordered. **Net Weight:** 2½ lb (1.2 kg).

Description	Catalog Number
1160-RDI-1B Digit-Insertion Unit, without filter plug	1160-9485
1160-CAD-1 Continuously Adjustable Decade (Includes Calibrating Mixer Unit)	1160-9432
Programmable Digit-Insertion Units	
1160-RDI-1B, with filter plug, up to 100 kHz/step, all synthesizer models	1160-9480
1163-RDI-4, 1 MHz/step, in 1163 models	1163-9479
1164-RDI-2, 1 MHz/step, in 1164 models	1164-9479
1164-RDI-3, 10 MHz/step, in 1164 models	1164-9489
Hook-Up Cable for all RDI's, 50-ft, 12-conductor, shielded	1160-9650

General-Purpose Oscillators

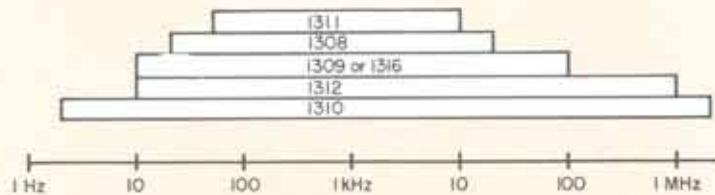

Type	Features	Page
1311	11 discrete frequencies, 1% accurate 1 W of power, up to 100 V or 4 A	79



1308	high power, 200 VA at any power factor useful in series with dc power circuit metered, protected	76
------	--	----



1309	low distortion — 0.05% 5-V output; 60-dB step attenuator sine waves and squares waves	77
------	---	----



1316	powerful — up to 1.6 W, 125 V metered, 5 A 2-phase outputs for phase-sensitive detector 3-digit decade control, infinite resolution low distortion and hum	158
------	---	-----



1310	widest frequency coverage, decade ranges 20-V output, 46-dB attenuator low distortion	78
------	---	----

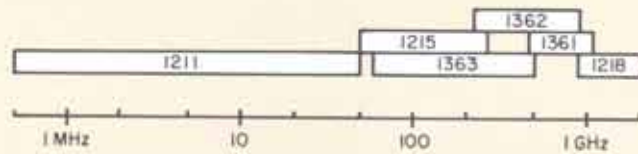

Type	Features	Page
1211	high output power: 200 mW to 2 W wide frequency coverage in 2 ranges	228



1215	output power: 50 to 300 mW quiet tuning (no sliding contacts)	228
-------------	--	-----



1363	output power: 90 to 500 mW front attenuator	229
-------------	--	-----



1362	uniform output power: 50 to 400 mW quiet tuning (no sliding contacts) calibrated front attenuator	229
-------------	---	-----



1361	output power: 100 to 400 mW quiet tuning (no sliding contacts) calibrated front attenuator	230
-------------	--	-----



1218	output power: 120 to 350 mW electrical fine tuning, can be phase locked high intrinsic stability front attenuator	230
-------------	--	-----

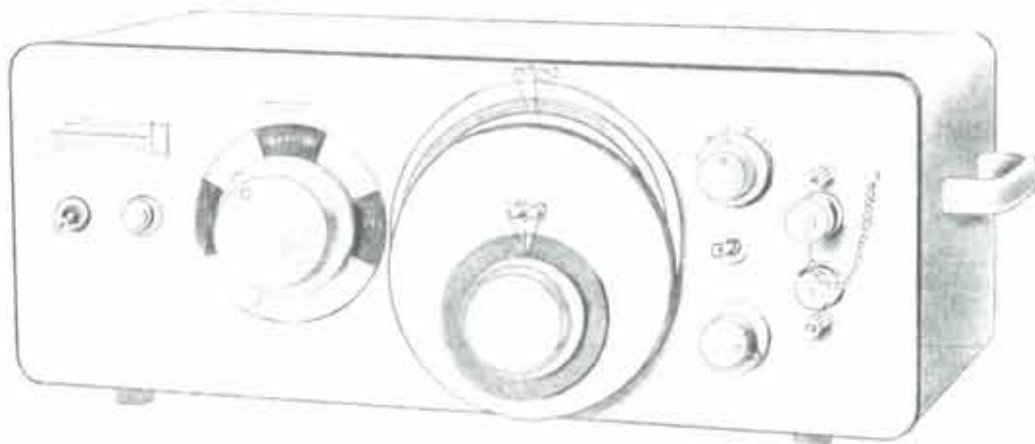

1330-A Bridge Oscillator

- 400 Hz to 50 MHz
- 0.5-watt output over most of rf range
- excellent shielding

The 1330-A is an economical, general-purpose laboratory source of audio and radio frequencies. It covers the major part of the frequency range of the 1606-B Radio-Frequency Bridge and also supplies 400 and 1000 Hz. Its power output is adequate for most direct-deflection-type measurements with resonant circuits.

The circuit and the mechanical construction are similar to those of the 1001-A Standard-Signal Generator. Tuning capacitor and inductors are ruggedly constructed to assure frequency stability, the oscillator circuits are doubly shielded to minimize stray fields, and a modulating circuit of unusual design provides excellent modulation characteristics over the radio-frequency range.

Modulation is available at two audio frequencies and at two levels, selected by switches.

SPECIFICATIONS

Frequency Range: 5 kHz to 50 MHz, continuous, plus 1000 Hz, 400 Hz, and the power-line frequency. **CALIBRATION:** Direct reading for eight 3:1 ranges. Calibration is logarithmic, and vernier dial indicates increments of 0.1% per division from 5 kHz to 15 MHz. **ACCURACY:** 400 and 1000 Hz, $\pm 5\%$; frequencies below 150 kHz, $\pm 3\%$; above 150 kHz, $\pm 2\%$, all at

no load. Frequency shift with 50- Ω load, 5% at low carrier frequencies; $< 1\%$ above 150 kHz.

Output Level: VOLTAGE: Audio, 12 V $\pm 20\%$, open circuit; rf, adjustable, maximum across 50 Ω is > 1.5 V at any frequency, > 2.5 V below 15 MHz, and > 5 V from 50 kHz to 5 MHz. POWER: Audio, > 500 mW into 50- Ω load; rf into 50- Ω load is: > 45 mW at any frequency, > 125 mW below 15 MHz, > 500 mW from 50 kHz to 5 MHz.

Output Impedance: Audio jack, 50 ± 20 Ω ; rf, < 80 Ω with output control at max setting.

Distortion: AUDIO: $< 5\%$, RF, with max output into 50 Ω : $\approx 3.5\%$, medium and high frequencies; $\approx 7\%$, low frequencies. ENVELOPE: $< 6\%$ at 50% modulation; $< 4\%$ at 25% modulation.

Modulation: Internal only, at 400 and 1000 Hz. DEPTH: 25% and 50%. CARRIER-FREQUENCY RANGE: 15 kHz to 50 MHz.

Leakage: Field strength < 50 $\mu\text{V}/\text{m}$ at 2 ft from instrument.

Terminals: GR874[®] locking connectors. For connection to other popular types, use a GR874 locking adaptor, which locks securely in place yet is easily removed.

Supplied: 874-R22LA Coaxial Cable, 874-Q2 Adaptor, T0-44 Adjustment Tool (mounted on rf shield cover), power cord.

Power: 105 to 125 or 210 to 250 V, 50 to 60 Hz; 30 W.

Mechanical: CABINET: Bench cabinet can be removed for easy mounting in a rack, without additional hardware. Panel dimensions, 19x7 in. DIMENSIONS: (wxhxd): 21.75x7.5x11.25 in. (552x190x286 mm). WEIGHT: 38 lb (17 kg) net, 50 lb (23 kg) shipping.

Description	Catalog Number
1330-A Bridge Oscillator \odot	1330-9701

\odot Federal stock numbers are listed before the index.

1340 Pulse Generator

- 0.2 Hz to 20 MHz
- 25-ns to 2.5-s duration
- 5-ns rise time
- 10-V output with ± 1 -V offset
- amplitude, period, duration modulation

The 1340 Pulse Generator demonstrates that an economical, general-use instrument need not be mediocre. The 1340 provides, at low cost, wide ranges of repetition frequency and duration, high output, and many performance and convenience features never before available in a single pulse generator.

A full eight decades of period and duration make the 1340 the widest-range pulse generator in its price class. A panel lamp indicates settings that exceed the generous duty-ratio limits. External signals can be used to control prf, to gate the output, and to modulate the amplitude, period, duration of the output pulses.

Both positive and negative ground-based pulses of up to 10 volts are produced simultaneously. Their amplitudes and offsets can be independently set with continuously adjustable front-panel controls. Control is also provided of output impedance, single pulsing, input threshold for external prf sources, and for generating square waves.

The sync output of the 1340 is a square wave. This feature not only permits pretriggering of an oscilloscope but ensures more positive triggering since input circuits operate best with a signal that keeps reasonable duration and constant dc level at all repetition rates.

Integrated-Circuit Testing Many features of the GR 1340 have been incorporated to aid in the testing of integrated circuits. Its 20-MHz operation, adjustable offset, square-wave output, and ability to operate at the standard 5-volt logic level with a 50- Ω source impedance are all of special value in IC testing. The ability to sweep or linearly program the pulse amplitude, duration, and period makes the 1340 useful in automatic and semi-automatic measurements.

— See *GR Experimenter* for November-December 1968.

SPECIFICATIONS

Pulse Period (PRF): INTERNALLY GENERATED: 50 ns to 5 s (20 MHz to 0.2 Hz) in 8 decade ranges. Single-pulse push button on panel. EXTERNALLY CONTROLLED: 1 Hz to 20 MHz; triggers on any waveform of >3 V pk-pk. Input resistance approx 100 k Ω . Output pulse is started by negative-going transition. Period control acts as input trigger-level control in external mode. ACCURACY (at 25°C, X2 setting): 10% for 10- μ s to 10-ms ranges; 15% for 1- μ s range; 20% for 100-ns and 1-s ranges. JITTER (max pk-pk): 0.2% at 500 ns, 5 ms, and 50 ms; 0.5% at 50 ns.

Output Pulse: DURATION: 25 ns to 2.5 s in 8 decade ranges, or square wave. ACCURACY (at 25°C, X1 setting): 10% for 1- μ s to 1-ms ranges; 15% for 10-ms range; 20% for 100-ns, 100-ms, and 1-s ranges. RISE AND FALL TIMES: 5 ns \pm 2 ns at 5 V, 50- Ω load, and 50- Ω source resistance. AMPLITUDE: Positive and negative ground-based pulses available simultaneously with independent amplitude and offset control. Source current continuously adjustable to at least 0.2 A (i.e., across 50- Ω load, 10 V from high source resistance or 5 V from 50- Ω source). JITTER (max pk-pk): 0.3% at 0.4 μ s. DISTORTION: Preshoot, overshoot, ringing, etc., <0.5 V (5% of max output).



Source Resistance: 50 Ω , or high (approx 1 k Ω) shunting current source.

Offset: Continuously adjustable source current from -20 to +20 mA.

Duty Ratio: Duty ratios of over 70% can be obtained on all ranges except decreasing to approx 50% at 50-ns period in 50-to-500-ns range.

Synchronizing Pulse: WAVEFORM: Square wave. Negative transition precedes start of output pulse by approx 35 ns; positive transition can be used for half-period pretriggering. AMPLITUDE: 2.5-V pk-pk positive square wave behind 500- Ω source impedance.

Modulation: Period and duration are linearly controllable by an external voltage between -0.5 and -5.0 V. Amplitude of the positive-pulse output is linearly controllable by an external voltage of 0 to +5.0 V, the negative pulse by 0 to -5.0 V.

Period and duration are modulatable over the decade range set by range switches; amplitude can be modulated over its full range. Amplitude modulation can be used for noncoherent gating of output pulse.

Gating: Switch closure to ground or equivalent inhibits period generator, thus providing phase-coherent gating of output pulses. An impedance of ≤ 600 Ω to ground inhibits output; +4 to +8 V allows normal output; 1340's gate 1340's.

Available: GR874* coaxial components, attenuators, terminations, tees, etc.

Power: 100 to 125 or 200 to 250 V, 50 to 400 Hz, 30 W.

Mechanical: Convertible bench cabinet. DIMENSIONS (wx hxd): Bench, 8.5x5.63x13 in. (216x143x330 mm); rack, 19x 5.25x11.25 in. (483x133x286 mm). WEIGHT: 9.5 lb (4.3 kg) net, 13 lb (6 kg) shipping.

Description	Catalog Number
1340 Pulse Generator	
Bench Mount	1340-9700
Rack Mount	1340-9701

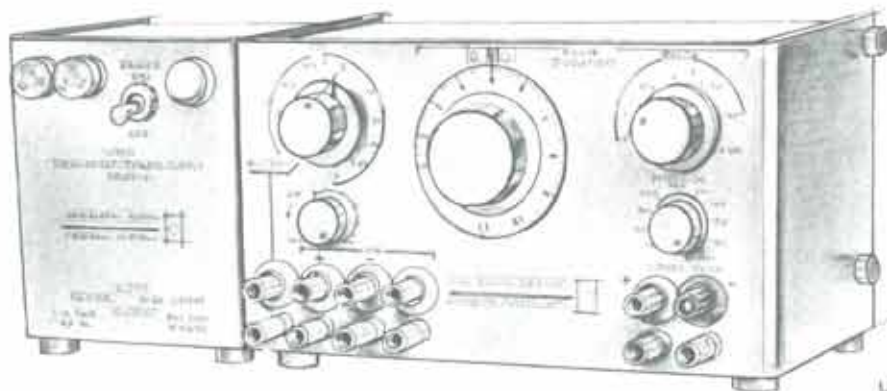

Unit pulse generator with power supply

1217-C Unit Pulse Generator

- <10-ns rise/fall times
- dc to 2.4-MHz repetition frequency
- 40-mA output pulses, positive and negative
- duration adjustable 100 ns to 1.1 s

This simple reliable pulse generator has many applications in the laboratory and on the test bench. Its wide ranges of pulse-duration and repetition rate and its excellent output characteristics fit it for many applications ranging from high-speed computing circuits through radar to geophysical and physiological pulse simulation. It is also an excellent, low-cost instrument for the student laboratory.

In addition to the main outputs (both + and - pulses) there are a sync input and three auxiliary outputs (+, -, and delayed sync). A separate input can be used for externally triggered pulses, aperiodic, periodic, or one-shot. A pushbutton is provided in the accessory Single-Pulse Trigger for manual control.



1217-P2 Single-pulse trigger

SPECIFICATIONS

Pulse Repetition Frequency, Internally Generated: 2.5 Hz to 1.2 MHz, with calibrated points in a 1-3 sequence from 10 Hz to 300 kHz, and 1.2 MHz, all $\pm 5\%$. Continuous coverage with an uncalibrated control.

PRF, Externally Controlled: Aperiodic, dc to 2.4 MHz with 1-V-rms input (0.5 V at 1 MHz and lower); input impedance at 0.5 V rms approx 100 k Ω shunted by 50 pF. Output pulse is started by negative-going input transition.

Output-Pulse Duration: 100 ns to 1 s in 7 decade ranges, $\pm 5\%$ of reading or $\pm 2\%$ of full scale or ± 35 ns, whichever is greatest.

Output Voltage: Positive and negative 40-mA current pulses available simultaneously. Dc-coupled; dc component negative with respect to ground. 40 V peak into 1-k Ω internal load impedance for both negative and positive pulses. Output control marked in approx output impedance.

Transitions: At max output into 50- or 100- Ω resistive load, transitions are typically <10 ns; no transition is ever >15 ns.

Overshoot typically <10% (worst case 15%). Output control permits reduction of overshoot at slight rise-time penalty. Into high-resistance loads, all transitions are $<(60 \text{ ns} + 2 \text{ ns/pF load capacitance})$, with no overshoot.

Ramp-off: Less than 1%.

Synchronizing Pre-pulse: Positive and negative 8-V pulses of 150-ns duration. If positive sync terminal is shorted, negative pulse and delayed sync pulse. This negative transition is immediate; positive — approx 300 Ω ; negative — approx 1 k Ω .



1- μ s pulse into 50 ohms with delayed sync pulse.

Delayed Sync Pulse: Consists of a negative-going transition of approx 5 V and 100-ns duration coincident with the late edge of the main pulse. Duration control sets time between pre-pulse and delayed sync pulse. This negative transition is immediately followed by a positive transition of approx 5 V and 150 ns to reset the input circuits of a following pulse generator.

Stability: Prf and pulse-duration jitter are dependent on power-supply ripple and regulation. With 1201 power supply and external-drive terminals short-circuited, prf jitter and pulse-duration jitter are each 0.01%. With 1203 power supply, they are 0.05% and 0.03%, respectively. (Jitter figures may vary somewhat with range switch settings, magnetic fields, etc.)

Power: 1203 or 1201 Unit Power Supply is recommended. Either of these power supplies matches the pulse generator in cabinetry, is the same height, and can be fastened alongside rigidly, with connectors mated directly (no cable). In performance, the 1201 is like the 1267 Power Supply except that the former's low-voltage output is unregulated, nominally 6.3 V, 0 to 4 A. In performance, the 1203 is like the 1269 Power Supply.

Available: 1217-P2 SINGLE-PULSE TRIGGER. Rack-adaptor panel for both generator and power supply (19 x 7 in. over-all).

Mechanical: Unit-instrument cabinet. DIMENSIONS (wxhxd): 15x5.75x6.5 in. (381x146x166 mm). WEIGHT: 9.5 lb (4.4 kg) net, 12 lb (6 kg) shipping.

Description	Catalog Number
1217-C Unit Pulse Generator	1217-9703
1201-C Unit Regulated Power Supply (for 115 V)	1201-9703
1201-CQ18 Unit Regulated Power Supply (for 230 V)	1201-9824
1203-B Unit Power Supply (for 115 V)	1203-9702
1203-BQ18 Unit Power Supply (for 230 V)	1203-9818
1217-P2 Single-Pulse Trigger	1217-9602
AA Cell, replacement battery for 1217-P2 (1 req'd)	8410-0300
480-P4U3 Rack-Adaptor Panel	0480-9986

⊕ Federal stock numbers are listed before the Index.



1396-B Tone-Burst Generator

- fast, coherent switch for periodic waves
- dc to 2 MHz
- signal attenuated > 60 dB between bursts
- length of burst: 10 μ s to 10 s, or continuous, or 1 to 129 periods of the switched signal
- or burst length controllable by separate input

The 1396-B Tone-Burst Generator fills the gap between steady-state cw testing and step-function, or pulse, testing of amplifiers, meters, etc. It is ideally suited for applications such as the test and calibration of sonar transducers and amplifiers, the measurement of distortion and transient response of amplifiers and loudspeakers, and routine testing of filters and ac meters. Still other uses are found in the measurement of room acoustics and automatic-gain-control circuits, in the synthesis of time ticks on standard-time radio transmissions, and in psychoacoustic instrumentation.

For a full discussion of the many uses for tone-burst testing see the May 1964, **General Radio Experimenter** or write for publications A130 and IN110.

Description The 1396 acts as a switch that alternately interrupts and passes an input signal, thus chopping into bursts a sine wave, or continuous tone, applied to the input. The instrument times the burst duration and interval between bursts exactly by counting the number of cycles, or periods, of the input signal. Panel controls permit these intervals to be set to a wide range of values. The exact time at which the burst starts and stops can be controlled, thus the burst is phase-coherent with the input signal.

Alternately, timing can be based on a separate signal, the output can be turned on continuously for alignment or calibration, or single bursts can be generated with a front-panel pushbutton. The 1396-B can also operate with nonsinusoidal or aperiodic inputs.

— See **GR Experimenter** for October 1968.

SPECIFICATIONS

Signal Input (signal to be switched): AMPLITUDE: ± 1 to ± 10 V pk-pk (7 V rms with 0-V dc component) for proper operation. FREQUENCY RANGE: Dc to 2 MHz. INPUT IMPEDANCE: 50 Ω , approx.

Timing Input (signal that controls switch timing): Same specifications as Signal Input except: INPUT IMPEDANCE: 20 Ω , approx.

Signal Output: OUTPUT ON: Replica of Signal Input at approx same voltage level; dc coupled; down 3 dB at >1 MHz. Output current limits at >25 mA pk, decreasing to >15 mA at 2 MHz. Output source impedance typically 25 Ω , increasing above 0.2 MHz. Total distortion contribution <0.3% at 1 kHz and 10 kHz. OUTPUT OFF: Input-to-output transfer (feed-through), <10 mV (<-60 dB re full output), dc to 1 MHz, increasing above 1 MHz. SPURIOUS OUTPUTS: Dc component and change in dc component due to on-off switching (pedestal) can be nulled with front-panel control. Output switching transients are typically 0.2 V pk-pk and 0.2 μ s in duration (120-pF load).

On-Off Timing: Timing is phase-coherent with, and controlled by, either the signal at the Signal Input connector or a different signal applied to the Ext Timing connector. The on interval (duration of burst) and the off interval (between bursts) can be determined by cycle counting, timing, or direct external control. CYCLE-COUNT MODE: On and off intervals can be set independently, to be of 1, 2, 4, 8, 16, 32, 64, or 128 cycles (i.e., periods) duration or to be 2, 3, 5, 9, 17, 33, 65, or 129 cycles with +1 switch operated. TIMED MODE: The on and off times can be set independently from 10 μ s to 10 s. They end at the first proper phase point of the controlling signal that occurs after the time interval set on the controls. One interval can be timed and the other counted, if desired. SWITCHING PHASE: For either of the above modes, the on-off switching always occurs at a phase of the controlling signal that is determined by the triggering controls. The Slope control allows triggering on either the positive or negative slope of the controlling signal and the Trigger Level control sets the level at which triggering occurs. DIRECT EXTERNAL CONTROL: A 10-V pulse applied to rear-panel connection will directly control switching.

Synchronizing Pulse: A dc-coupled aux output alternates between approx +8 V (output on) and -8 V (off). SOURCE RESISTANCE: ≈ 0.8 k Ω for pos output and ≈ 2 k Ω for neg.

Power: 100 to 125 or 200 to 250 V, 50 to 400 Hz, 16 W.

Mechanical: Convertible bench cabinet. DIMENSIONS (w x h x d): Bench, 8.5x5.63x10 in. (216x143x254 mm); rack, 19x5.63x10 in. (483x143x254 mm). WEIGHT: Bench, 8 lb (3.7 kg) net, 12 lb (5.5 kg) shipping; rack, 11 lb (5 kg) net, 15 lb (7 kg) shipping.

Description	Catalog Number
1396-B Tone-Burst Generator	
Bench Model	1396-9702
Rack Model	1396-9703

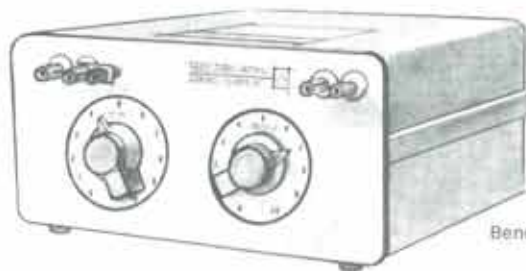

Bench and rack models

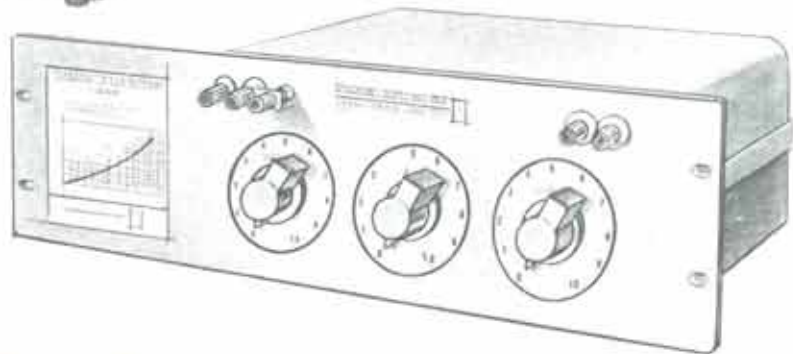

1450 Attenuator Decade

- 0 to 110 dB in steps of 0.1 or 1 dB
- 600-ohm input and output impedance
- accuracy: ± 0.02 dB $\pm 0.25\%$
- usable to 1 MHz

Use the 1450 Decade Attenuator to provide accurate steps of attenuation for power-level measurements, transmission-efficiency tests, and gain or loss measurements on transistors, filters, amplifiers, and similar equipment. It can also serve as a power-level control in circuits not equipped with other volume controls.

Each decade consists of four individually shielded, series-connected T-pads. The switches have eleven positions, 0 to 10 inclusive, so the decades overlap. There are no stops on the 0.1- and 1-dB-per-step decades, thus facilitating quick return from full to zero attenuation.

SPECIFICATIONS

Attenuation Range: 110 or 111 dB in steps of 1 or 0.1 dB, respectively.

Terminal Impedance: 600 Ω nominal in either direction. An etched plate indicates the mismatch loss for other than 600- Ω circuits.

Accuracy: Each individual resistor is adjusted within $\pm 0.25\%$ of its correct value. The low-frequency error in attenuation is less than ± 0.02 dB $\pm 0.25\%$ of indicated dB setting plus a switch-resistance error of 0.003 dB (for -TA) or 0.005 dB (for -TB), when attenuator is terminated at both ends in a pure resistance of 600 Ω . For differences in attenuation between any two settings, switch-resistance error virtually disappears. To maintain accuracy at high attenuations, special wiring methods are employed to the "low" input post.

Frequency Discrimination (with low terminal at panel potential): Less than 0.1 dB $\pm 1\%$ of the indicated value at frequencies below 200 kHz. For increments in attenuation, the 1% tolerance extends to approximately 1 MHz.

Maximum Input Power: 1 W.

Switches: Cam-type switches are used with twelve positions covering 360°. Dials are numbered from 0 to 10 inclusive, and the twelfth point is also connected to 0. Stops are provided in the switch mechanism for the 100-dB decade. No stops are provided initially to prevent complete rotation of the 10- and 1-dB decades, but spacers, which are provided, can be used under certain mounting screws to act as stops for the knob, if desired.

Characteristic Impedance: 600 Ω ; if one end is terminated in 600 Ω , the input impedance at the opposite end is 600 Ω , for any attenuation setting.

Terminals: Low-thermal-emf jack-top binding posts with $\frac{3}{4}$ -in. spacing; ground ("G") terminal also provided, near Input.

Shielding: Each decade is individually shielded, and all shields are connected to the panel, to which the "G" post is also connected. The user is thus given free choice of grounding point for the "low" side, including connection to "G" by the link provided.

Mechanical: Lab-bench cabinet or rack model. **DIMENSIONS** (wxhxd): 2-dial models, 10x5.75x12.25 in. (254x146x311 mm); 3-dial models, 12x5.75x12.25 in. (305x146x311 mm); all rack, 19 x same h and d (483 mm). **WEIGHT:** -TA, 11 lb (5 kg) net, 17 lb (8 kg) shipping; -TB, 15 lb (7 kg) net, 20 lb (9.5 kg) shipping; -TAR, 12 lb (5.5 kg) net, 23 lb (11 kg) shipping; -TBR, 16 lb (7.5 kg) net, 26 lb (12 kg) shipping.

Description	Dials	Attenuation Total	Steps	Catalog Number
Decade Attenuator				
1450-TA, Bench \oplus	2	110 dB	1 dB	1450-9891
1450-TAR, Rack	2	110 dB	1 dB	1450-9894
1450-TB, Bench \oplus	3	111 dB	0.1 dB	1450-9893
1450-TBR, Rack	3	111 dB	0.1 dB	1450-9895

\oplus Federal stock numbers are listed before the Index.

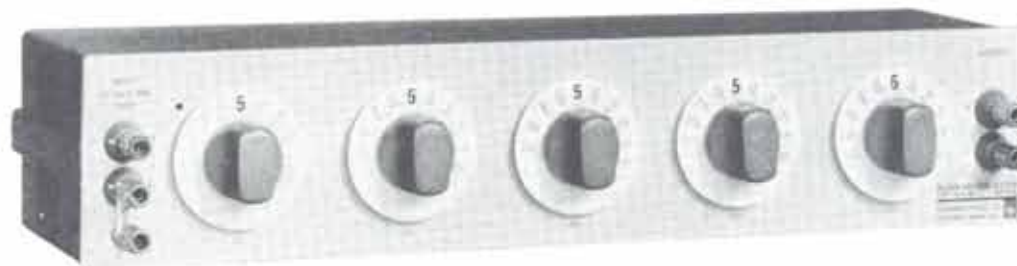

1455 Decade Voltage Divider

- linearity better than 20 ppm (5-dial model)
- input impedance: 1, 10, or 100 kΩ
- high-frequency model, down 3 dB at 7.5 MHz

The GR 1455 Decade Voltage Dividers provide accurately known voltage ratios from 0.00001 to 1.00000 for use in many common measurements:

- voltage gain or attenuation
- linearity of potentiometers and other controls
- frequency response of audio and rf networks
- transformer turns ratio
- voltmeter calibration

A resistive divider of the Kelvin-Varley type, the 1455 has precision resistors throughout (rather than in selected positions only) for over-all high accuracy. Linearity is as low as 0.02 ppm of input.

Match your needs exactly. Select input impedance, voltage rating, frequency range, 4- or 5-dial resolution, bench or rack mounting.

models, 7.75 lb (3.6 kg) net, 9 lb (4.1 kg) shipping; rack models are each 1 lb (0.5 kg) heavier than corresponding bench models.

Type	1455-AH	-A	-AL	-BH	-B
Number of Dials:	4	4	4	5	5
Input Resistance:	100 kΩ	10 kΩ	1 kΩ	100 kΩ	10 kΩ
Accuracy of Input R: (ppm)	+150	+150	+250	+150	+150
Input Voltage Rating ¹ :	700 V	230 V	70 V	700 V	230 V
Frequency Response ² f _c :	85 kHz	850 kHz	7.5 MHz	69 kHz	690 kHz
Resolution: (ppm of input)	100	100	100	10	10
Linearity (sum of A & B)					
A, Absolute Linearity ³					
— Ratio —					
0.00001 to 0.00010	—	—	—	±0.02	±0.03
0.00010 to 0.00100	±0.2	±0.3	±0.7	±0.2	±0.3
0.00100 to 0.01000	±2	±2	±3	±2	±3
0.01000 to 0.10000	±15	±15	±20	±10	±10
0.10000 to 1.00000	±30	±30	±50	±20	±20
B, Terminal Linearity ⁴					
(in ppm of input).					
FOUR-TERMINAL (output with respect to low output terminal):	±0.004	±0.04	±0.4	±0.004	±0.04
THREE-TERMINAL ⁵ :	±0.02	±0.2	±2	±0.02	±0.2
Max Output Resistance (input shorted):	27.9 kΩ	2.79 kΩ	333 Ω	28.8 kΩ	2.88 kΩ
Effective Output Capacitance (typ, unloaded):	67 pF	67 pF	67 pF	80 pF	80 pF

¹ Safe operating limit, will not cause damage.

² Output-level change due to increasing frequency, with no load, with output resistance set to max, up to the tabulated frequency: <3 dB.

³ Measured in ppm of input. Output is taken with respect to reference output measured when the indicated ratio is zero, with frequency in the low audio range, with input <0.5 of Input Voltage Rating. Note: Linearity change due to internal heating, for full rated input voltage, for ratios 0.1 to 1.0: <20 ppm; for ratios <0.1: negligible.

⁴ Output measured with respect to low input terminal. Low output terminal may be floating or connected to the low input terminal.

SPECIFICATIONS

Frequency Characteristic: Acts like simple RC circuit below f_c, so that

$$\frac{E_o}{E_i} = \frac{\text{reading}}{\sqrt{1 + \left(\frac{f}{f_c}\right)^2}}$$

Tabulated value of f_c is at setting that gives max output resistance so that f_c at all other settings is higher. At 0.044 f_c, response is down <0.1%.

Temperature Coefficient: <20 ppm for each resistor. Since voltage ratios are determined by resistors of similar construction, net ambient temperature effects are very small.

Mechanical: Lab-bench cabinet. DIMENSIONS (wxhxd): Bench, 4-dial models, 14.75x3.5x6 in. (375x89x153 mm); 5-dial models, 17.31x3.5x6 in. (440x89x153 mm); rack, 19x3.5x4.63 in. (483x89x117 mm). WEIGHT: Bench, 4-dial models, 6.75 lb (3.1 kg) net, 8 lb (3.7 kg) shipping; 5-dial

Description	Catalog Number
1455 Decade Voltage Divider	
Bench Models	
1455-A, 4-dial, 10-kΩ	1455-9700
1455-AH, 4-dial, 100-kΩ	1455-9702
1455-AL, 4-dial, 1-kΩ	1455-9704
1455-B, 5-dial, 10-kΩ	1455-9706
1455-BH, 5-dial, 100-kΩ	1455-9708
Rack Models	
1455-A, 4-dial, 10-kΩ	1455-9701
1455-AH, 4-dial, 100-kΩ	1455-9703
1455-AL, 4-dial, 1-kΩ	1455-9705
1455-B, 5-dial, 10-kΩ	1455-9707
1455-BH, 5-dial, 100-kΩ	1455-9709

⊕ Federal stock numbers are listed before the index.

Other Attenuators

1452 Programmable Attenuator (full specifications on page 246)

- 10 kHz to 500 MHz
- 80 dB in 1-dB steps
- 1% accuracy
- <500- μ s switching time

A precision control for rf-signal strength in 50-ohm circuits, excellent in computer-controlled test systems for communications equipment. Manual or programmable-only models.



1346 Audio-Frequency Microvolter* (full specifications on page 92)

- economical, easy to use
- dc-to-100 kHz attenuator
- 0.1- μ V to 10-V output from internal dc or external ac/dc source

Handy, versatile metered attenuator converts any source of dc or ac-to-100 kHz to a calibrated-output generator. 1001 uses include testing of sensitivity, linearity, s/n ratio, and attenuation on instruments, audio equipment, bio-systems.



* Trademark registered in USA



1157-B Scaler (500 MHz)

- inputs up to 500 MHz
- 100-mV rms input sensitivity
- 1-V output behind 50 Ω

The 1157-B Scaler will divide input frequencies up to 500 MHz by 10:1 or 100:1. Used as a prescaler, it will extend the upper frequency limit of counters to as much as 500 MHz. It can be mounted side-by-side with the 1191 or 1192 Counter to extend its range to 500 MHz with 10:1 or 100:1 prescaling.

The 1157-B Scaler is a two-decade digital frequency divider complete with input-level meter, attenuator, and internal power supply. One output can be switched for either 1/10 or 1/100 of the input frequency; a sync output supplies 1/100 of the input continuously. The input and output connectors can be moved to the rear for systems applications.



A perfect companion to the 1192 Counter, the 1157-B extends the counter's range to 500 MHz. Equally useful with the 1191-B Counter.

SPECIFICATIONS

Input Frequency: 1 to 500 MHz.

Input Level: MINIMUM: 0.3 V pk-pk (0.1 V rms) on most sensitive setting of attenuator. MAXIMUM: 7 V rms (1 W).

Input Impedance: AC-coupled, 50 Ω .

Attenuator (Sensitivity control): Panel switch of x1, x2, x5 or x10 attenuation.

Meter: Green sector indicates adequate signal levels for easy adjustment of sensitivity control.

Main Output: DC-coupled positive pulse, > 1 V behind 50 Ω . REPETITION RATE: Input frequency divided by 10 or 100 depending on setting of panel switch. DUTY RATIO: 60% for 1/10 output, 40% for 1/100 output.

Sync Output: Positive pulse, > 1 V behind 50 Ω . Repetition rate is input frequency divided by 100. Duty ratio, 60%.

Connectors: Can be moved to rear panel. INPUT: GR874* locking connector. OUTPUT: BNC.

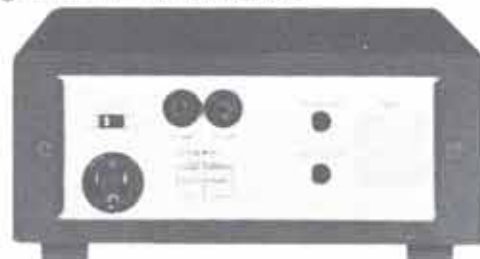

The input and output connectors can be moved to the rear for systems applications.

Supplied: Power cord, patch cord to 1192 Counter.

Power: 100 to 125 or 200 to 250 V, 14 W.

Mechanical: Convertible bench cabinet. DIMENSIONS (wxd): Bench, 8.5x3.5x12.6 in. (216x89x309 mm); rack, 19x3.88x12.6 in. (483x98x320 mm). WEIGHT: Bench, 7 lb (3.2 kg) net, 10 lb (4.6 kg) shipping; rack, 10 lb (4.6 kg) net, 13 lb (6 kg) shipping.

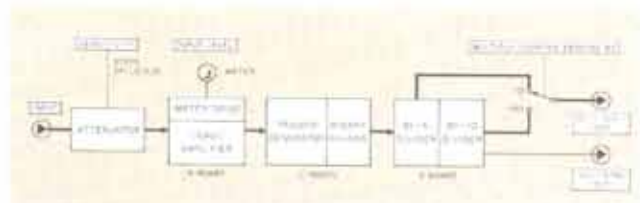

Two frequency-divider circuits allow an output that is one-tenth the input frequency or one-hundredth of it.

Description	Catalog Number
1157-B Scaler (500 MHz)	
Bench Model	1157-9700
Rack Model	1157-9701

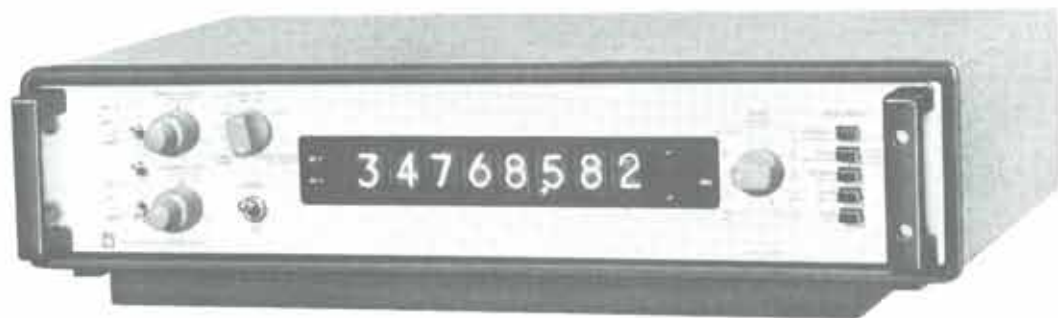

1191-B Counters

- 35 MHz, to 500 MHz with scaler
- general-purpose counter-timer
- economical IC design
- programmable, all functions dc controlled
- 10-mV sensitivity

The 1191 is a general-purpose counter-timer for measuring frequency, period, period average, frequency ratio, and time interval. Extensive use of integrated circuits in the 1191 has resulted in an economical counter with full features and top performance.

Operation to 500 MHz The 1191-B counter is available as the 1191-Z in combination with a scaler that extends the frequency-measuring range to 350 or 500 MHz by dividing the input frequency by a factor of 10 or 100.

In combination, the 1191 Counter and a scaler are economical and provide all the features of the counter alone, full counter-timer functions, programmability, high-speed data access, with the extra benefits of high-frequency operation. 1191-Z models include all counter options — high-precision time base and data output.

The counter and scaler are offered in rack-mount or bench versions, the latter supplied with the two instruments mounted in a single cabinet.



Type 1191-Z 500-MHz Counter.

Automatic Remote programmability of measurement functions, ranges, and most of the secondary controls, such as display time, makes the 1191 unexcelled as a component in automatic measuring systems. Its display time can be as small as 1 μ s. The counter functions are dc controlled, most by simple contact closures to ground. Models are available with high-speed, buffered BCD outputs from internal storage to drive auxiliary data-handling equipment.

Convenience The readout of the 1191 is 8 digits of high-intensity neon indicators, with automatic display of decimal point and measurement dimensions. The internal storage gives continuous, flicker-free display of rapidly corrected data. The operator has control of all input trigger circuit characteristics.

Input Circuits The counter has two high-sensitivity input channels, each consisting of a high-impedance, low-noise FET circuit preceded by a 3-position step attenuator and including controls for trigger level, slope and polarity. The 1-megohm input impedance is independent of control settings to permit use of general-purpose low-capacitance oscilloscope probes. One such probe is offered as an accessory to the 1191.

Time Base Model options allow a choice of time base to match needs and budgets. An inexpensive room-temperature-crystal oscillator affords adequate stability for many applications. Or, the counter can be ordered with a more stable crystal-oscillator time base with proportional temperature control. A standby-power mode of operation lets the crystal oven remain on for maximum stability, while the rest of the counter is turned off. For the greatest possible stability, either oscillator can be phase locked to an external standard frequency of 10 MHz or any submultiple down to 100 kHz. A front-panel monitor is included for this purpose. If necessary, oscillator frequency can be set with an easily accessible, rear-panel dc-voltage adjustment.

SPECIFICATIONS

MEASUREMENT RANGES AND ACCURACY

Frequency: Dc to 35 MHz; 1- μ s to 10-s counting gate times. Accuracy, ± 1 count = time-base accuracy.

Strobed Period: Period to 10⁶ s less display time (<1 μ s to 10 s), measured by counting 0.1- μ s to 10-s intervals derived from internal 10-MHz clock. Accuracy, see note.

Single and Multiple Period: 1 to 10⁶ periods measured by counting internal 10-MHz clock. Accuracy, see note.

Time Interval: 0.1 μ s to 10⁶ s measured by counting 0.1- μ s to 10-s intervals derived from internal 10-MHz clock. Accuracy, see note.

Frequency Ratio: 1 to 10⁶. Frequency "A", dc to 35 MHz, is measured over 1 to 10⁶ periods of frequency "B", dc to 10 MHz. Accuracy, ± 1 count of "A" = trigger error of "B" (see note).

Count: Register capacity, 10⁶. Events at rates up to 35 MHz are accumulated between "start" and "stop" commands from manual panel buttons or, externally from contact closures or solid-state switches. In "count", storage is automatically disabled.

Note — Error in time measurements: $\pm 0.3\%$ of one period \div number of periods averaged, for a 40-dB input signal-to-noise ratio. This assumes no noise internal to the counter. For input signals of extremely high signal-to-noise ratio, the trigger error in μ s will be $< 0.0005 \div$ the signal slope in V/ μ s. In addition, all time measurements are subject to the ± 1 -count gating error and to time-base accuracy.

INPUT CHARACTERISTICS

Frequency: Channel "A", dc to 35 MHz (3 Hz to 35 MHz ac-coupled); channel "B", dc to 10 MHz (3 Hz to 10 MHz ac-coupled).

Sensitivity: 10 mV rms sine wave, 30 mV pk-pk pulse decreasing above 20 MHz to approx 100 mV rms at 35 MHz. Trigger level variable ± 100 mV.

Attenuator: x1, x10, x100 (0, 20, 40 dB); low-capacitance 10:1 probe available.

Voltage Rating: Input voltage should not exceed 150 V on x1 or 300 V on x10 or x100.

Impedance (all attenuator settings): Approx 1 M Ω shunted by 35 pF. At rear connectors (supplied mounted, unwired), shunt C increases to approx 70 pF.

Signal Polarity: Front-panel control permits selection of positive- or negative-going signal sense for triggering.

10-MHz TIME-BASE OSCILLATORS

Room-Temperature Oscillator (standard)

Stability: $< 2 \times 10^{-6}/^{\circ}\text{C}$ from 0 $^{\circ}$ to 50 $^{\circ}\text{C}$. Drift less than $\pm 2 \times 10^{-6}$ per month. With $\pm 10\%$ line-voltage variation, $< 2 \times 10^{-6}$.

Manual Adjustment Range: $\pm 1 \times 10^{-4}$ at rear-panel control.

High-Precision Oscillator (in proportional-control oven) (optional)

Stability: $< 2 \times 10^{-6}/^{\circ}\text{C}$ from 0 $^{\circ}$ to 50 $^{\circ}\text{C}$ when operated continuously. Drift $\pm 1 \times 10^{-6}$ per week, approx 1×10^{-6} per day after 1 month of continuous operation. With $\pm 10\%$ line-voltage variation, $< 2 \times 10^{-6}$.

Manual Adjustment Range: $\pm 1 \times 10^{-4}$ at rear-panel control.

Time-Base Output: 10-MHz square wave, 2 V pk-pk behind 50 Ω at rear-panel BNC connector.

External Phase-Lock: Both time-base oscillators can be locked to external standard frequency at 0.1, 1, 2.5, 5, or 10 MHz, of at least 1 V rms into 1 k Ω . A front-panel phase-lock indicator lamp is provided.

DATA PRESENTATION

Display: 8-digit display with automatically positioned decimal point and measurement dimensions. High-intensity neon read-out tubes.

Storage: Display can be either stored or not; variable from $< 1 \mu$ s to 10 s or infinity for display time (normal mode) and for data holdoff time (in storage mode).

Data Output (in some models): Fully buffered 1-2-4-8 BCD output at standard DTL levels; data zero is 0.5 V max and data 1 approx 5 V behind 6 k Ω .

PROGRAMMING

Input: All instrument functions controllable by closure to ground within capabilities of DTL micrologic (2- to 6-mA sink current required), except functions:

Input Threshold: Requires dc voltage of ≈ 100 mV corresponding to desired threshold level.

Display Time: Requires RC circuit to ground.

Nonprogrammable functions: Input attenuator, input ac/dc coupling, separate/common switch, self-test, internal/external control of time-base oscillator, and frequency adjustment of time-base oscillator.

GENERAL

Environment: Instrument operating range, 0 to 50 $^{\circ}\text{C}$ ambient.

Supplied: Rack-mounting hardware set, power cord.

Available: Input probe; 1157-B Scaler for measurement to 500 MHz; 1785 Digital Printer, and other GR digital-data acquisition equipment.

Probe (1158-9600): INPUT IMPEDANCE: 10 M Ω shunted by approx 7 pF when used with 1191 counter. ATTENUATION: x10 (20 dB). VOLTAGE: 600 V dc or ac pk-pk, max up to 5.7 MHz; less at higher frequencies. LENGTH: 3.5 ft.

Power: 100 to 125 or 200 to 250 V, 50 to 400 Hz, 32 W.

Mechanical: Bench or rack models. **1191-B DIMENSIONS:** (wxhxd): Bench, 19.75x4.88x13 in. (502x124x330 mm); rack, 19x3.5x10.5 in. (483x89x267 mm). WEIGHT: Bench, 23 lb (11 kg) net, 29 lb (14 kg) shipping; rack, 18 lb (8 kg) net, 21 lb (10 kg) shipping. **1191-Z DIMENSIONS:** (wxhxd): Bench, 19.75x8.75x15 in. (502x222x381 mm); rack, 19x7x13.25 in. (483x178x337 mm). WEIGHT: Bench, 38 lb (18 kg) net, 45 lb (21 kg) shipping; rack, 38 lb (18 kg) net, 45 lb (21 kg) shipping.

Description	Catalog Number
1191-B Counter	
Bench Model	1191-9710
Rack Model	1191-9711
Bench Model with Data Output Option	1191-9712
Rack Model with Data Output Option	1191-9713
Bench Model with High-Precision Time-Base Option	1191-9714
Rack Model with High-Precision Time-Base Option	1191-9715
Bench Model with both Options	1191-9716
Rack Model with both Options	1191-9717
1191-Z Counter (500 MHz)	
Bench Model with both Options	1191-9904
Rack Model with both Options	1191-9905
P6006 Probe , Tektronix Catalog No. 010-0127-00 (not sold separately)	1158-9600

PATENT NUMBER 3,328,564.



1192-B Counter

- dc to 50 MHz; 500 MHz with scaler
- 10-mV sensitivity
- stable time base
- low cost
- optional 5, 6, or 7 digits and data output
- FCC type — approved for a-m, fm, vhf, and tv monitoring

A winner Thanks to efficient IC design and automated testing, the 1192-B costs substantially less than larger instruments but still provides all their versatility; you receive all five basic measurement capabilities:

- frequency to 50 MHz
- period to a resolution of 0.1 μ s
- time interval to a resolution of 0.1 μ s
- frequency ratio averaged to 10^4
- count up to 50 million events per second

With all features retained The 1192-B is equipped with an internal crystal time base of exceptionally good stability. Its input sensitivity is 10 times that of similar units,

and the input circuits provide operator control of trigger level, coupling, and attenuation for greater immunity to input noise and greater adaptability to unusual signals.

The clear, bright readout includes the units of measurement, an automatically positioned decimal point, and indicators for signal-counting and spill. The measurement modes are controlled by simple unambiguous pushbuttons and gate times are set by a single control. Internal storage permits the readout to display only the final result but can be disabled to permit you to see the actual counting process.

A second input channel permits the measurement of normalized frequencies by the insertion of an external time base of arbitrary frequency. Time interval and count



1192-Z 500-MHz Counter.

measurements can be externally controlled by a variety of signals and, with auxiliary connections, time-interval range can be extended, the time-base can be phase-locked to an external standard frequency and internal standard frequencies can be brought out.

SPECIFICATIONS

Frequency Measurements: DC to 50 MHz; 100- μ s to 10-s counting gate times; displays Hz, kHz, MHz units with positioned decimal point. **ACCURACY:** ± 1 count \pm time-base accuracy.

Period Measurements: 0.1- μ s resolution; single and multiple period of 10³; displays ms, μ s, ns units with positioned decimal point; counts 10-MHz time base, 1 MHz, and 100 kHz. **ACCURACY:** Depends on signal-to-noise ratio of input signal, input noise, and ± 1 -count error \div number of periods counted (see note).

Frequency Ratio Measurements: 1 to 10³. Frequency A, dc to 50 MHz, is measured over 1 to 10³ periods of frequency B, 50 Hz to 10 MHz. **ACCURACY:** ± 1 count of A \pm trigger error of B \div number of ratios counted (see note).

Time Interval and Duration Measurements: **TIME INTERVAL:** 0.1-, 1-, or 10- μ s resolution measured by counting 10-, 1-, or 0.1-MHz signal from internal clock; displays ms with positioned decimal point. Interval measured is between separate commands applied to START and STOP BNC connectors on rear. **PULSE LENGTH:** Measures duration of pulse applied to START connector with STOP connector grounded. Storage is disabled in this mode. Counter will also total many time intervals. **ACCURACY:** ± 1 count \pm time-base accuracy.

Count Measurements: Register capacity, 10³, 10⁴, 10⁵ depending on version. Events at up to 50-MHz rate accumulated between start/stop commands from manual panel button or by separate start and stop commands applied to rear BNC connectors, or only during start command with stop connector grounded. Counter will also totalize all events during many openings of the gate.

NOTE: Trigger error in time measurements: $\pm 0.3\%$ of one period \div number of periods averaged, for a 40-dB input signal-to-noise ratio. This assumes no noise internal to the counter. For input signals of extremely high signal-to-noise ratio, the trigger error in μ s will be $< 0.0003 \div$ signal slope in V/ μ s.

	A Input	B Input
Frequency	dc to 50 MHz (3 Hz to 50 MHz ac coupled)	50 Hz to 10 MHz
Sensitivity	10 mV rms to 20 MHz 20 mV rms to 35 MHz 30 mV rms to 50 MHz	1 V rms, 50 to 400 Hz 100 mV rms to 10 MHz
Trigger level	adjustable $\pm 0.1, 1, 10,$ or 100 V depending on attenuator setting	fixed
Attenuator	negative-going $\times 1, \times 10, \times 100, \times 1000$ (0, 20, 40, 60 dB)	negative-going none
Maximum signal	400 V pk ac or dc, ex- cept 300 V when dc coupled at 1:1 atten.	400 V dc, 80 V rms
Impedance	1 M Ω / \approx 27 pF (10 M Ω / \approx 7 pF with probe)	10 k Ω / \approx 20 pF

Start/Stop Inputs: Closure to ground at 6-mA max sink or pulse with logic 0 of $< +0.3$ and logic 1 of $> +2$ -V levels and 1 W max into 50 Ω , or pulse of -7 and $+12$ V dc or ± 70 V for short, 1% duty ratio.

Data Presentation: **DISPLAY:** 5, 6, or 7 digits; long-life, high-intensity neon readout tubes with automatically positioned decimal point and measurement dimension; Spill lamp lights if register capacity exceeded; Count lamp lights when meas-

Plus tailored performance Options permit a broad selection of the right model for your application: If 5-digit precision isn't adequate, choose 6 or 7. If data output is required for system use and automatic data reduction, order option 2. If it is to be mounted with other instruments, select a rack model. If pink panels and chartreuse knobs are called for, you may be out of luck but, if measurements to 500 MHz are necessary, use the 1192-Z.

Up to 500 MHz In combination with the 1157-B Scaler, the 1192-B frequency range is extended to 500 MHz. Both units, mounted side by side, are completely assembled as the 1192-Z Counter. They can be supplied as either bench or rack models with all the selection of digits and options available in the 1192-B alone.

urement is in progress. **MEASUREMENT RATE:** Time between measurements adjustable from 10 ms to > 10 s and ∞ . **STORAGE:** Display and Spill lamp can be either stored or not, as controlled by rear pushbutton.

Data-Output Option 2: Fully buffered 8-4-2-1 BCD signals at standard DTL levels (logic 0 $\leq +0.5$ V, logic 1 = $+3.5$ to $+5$ V behind 6 k Ω) available at rear 50-pin type 57 connector.

Time Base: **FREQUENCY:** 10 MHz. **STABILITY:** $< \pm 1.5 \times 10^{-4}$ /month. Room-temperature crystal coefficient, $< \pm 3 \times 10^{-7}$ /°C from 0 to 55°C. Total deviation from frequency at room temperature, $< \pm 5 \times 10^{-8}$ from 0 to 55°C. With 10% line-voltage variation, $< \pm 2 \times 10^{-8}$. **MANUAL ADJUSTMENT RANGE:** $\pm 1 \times 10^{-3}$ with internal control. **INTERNAL PHASE LOCK:** Time-base oscillator can be locked to external standard frequencies at 1 MHz and 100 kHz of ≥ 100 mV rms into 10 k Ω . Lock range $> \pm 1 \times 10^{-3}$. **OUTPUT:** 100 kHz, and 1 MHz.

Environment: **TEMPERATURE:** 0 to $+55^\circ$ C operating, -40 to $+75^\circ$ C non-operating. **HUMIDITY:** 95% RH and $+40^\circ$ C. **VIBRATION:** 0.03 in. from 10 to 55 Hz. **BENCH HANDLING:** 4 in. or 45" (MIL STD-810A-VI). **SHOCK:** 30 G, 11 ms.

Available: 1157-B Scaler to extend frequency range to 500 MHz, data printer, digital-to-analog converter, GR digital acquisition equipment, 1158-9600 10:1 low-capacitance probe.

Power: 100 to 125 and 200 to 250 V, 50-400 Hz, 22 W max. **Mechanical:** Convertible-bench cabinet. **DIMENSIONS (wxhxd):** Bench, 8.5x3.88x12.6 in. (216x99x320 mm); rack, 19x3.5x12.6 in. (483x89x320 mm). **WEIGHT:** Bench, 8.4 lb (3.9 kg) net, 10.6 lb (4.9 kg) shipping; rack, 11 lb (5 kg) net, 15 lb (7 kg) shipping.

1192-Z SPECIFICATIONS

Same as 1192 except:

Frequency: DC to 500 MHz.

Input to 1157-B Scaler above 50 MHz; **SENSITIVITY:** 100 mV rms, 300 mV pk-pk. **MAXIMUM SIGNAL:** 7 V rms (1 W). **IMPEDANCE:** 50 Ω , ac coupled.

Power: 100 to 125 and 200 to 250 V, 50-400 Hz, 36 W max.

Mechanical: Bench or rack models. **DIMENSIONS (wxhxd):** Bench, 17x3.88x14 in. (432x98x356 mm); rack, 19x3.5x12.75 in. (483x89x324 mm). **WEIGHT:** Bench, 15 lb (7 kg) net, 20 lb (9 kg) shipping; rack, 16 lb (8 kg) net, 21 lb (10 kg) shipping.

Description	Catalog Number
1192-B Counter (50 MHz) Bench Model* Rack Model*	
1192-Z Counter , with scaler (500 MHz) Bench Model* Rack Model*	(Describe exactly as shown at the left.)
Select one of the following options	
5-Digit Readout	
6-Digit Readout	
7-Digit Readout	
Select the following option, if desired	
OP2 Data Output, BCD	
Accessory available with counter	
Probe (10:1, low capacitance); not sold separately, same as Tektronix P6006, 010-0127-00	

1158-9600

*Your order must specify 5, 6, or 7 digits.

Patent Number: 3,328,564.

Miscellany

Parts

Rack Adaptors and Sets

Cabinets and Mounting

Mechanical Specifications

Abbreviations

Reactance Charts

Decibel Conversion Tables

Federal Stock Numbers

Index



938 Binding Posts

- wide selection
- gold-plated copper for low thermal emf or nickel-plated brass for economy
- four colors in metal and plastic
- excellent electrical characteristics

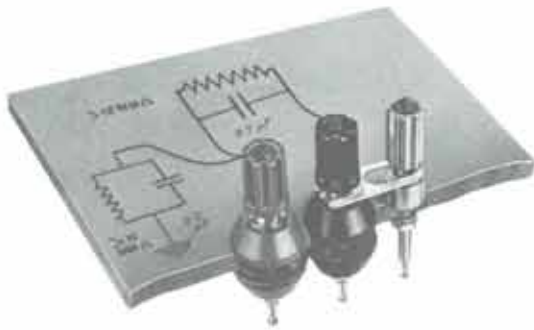

The excellent electrical properties and ingenious mechanical design of the GR 938 Binding Posts provide all the properties needed for modern electronic instruments. Two styles are available: Nickel-plated brass for economy,

and gold-plated copper for high conductivity and low thermal emf with connection to copper wires. Both styles are available with either metal or insulated tops designed for easy hand-tightening, or $\frac{3}{8}$ -in., 12-point wrenches can be used for more permanent connections. The polycarbonate insulation has high insulation resistance and low dissipation factor and is available in red and black, for color coding.

These binding posts can be mounted on metal or non-conducting panels of any thickness up to 0.32 in. (8 mm). There is 0.62-in. clearance between panel insulators when binding posts are mounted at standard spacing, 0.75 in. (19 mm) between centers. Mechanical details and methods of connection are shown in the drawings.

Jack-top The hollow binding post doubles as a banana jack, allowing secure connection even while the nut is loose or clamped onto a wire. The binding post has the same height above a panel as the nonlocking GR874® coaxial connector, the center contact of which will also function as a banana jack. Therefore, a grounded binding post spaced 0.75 in. from a GR874 connector makes a useful combination that will receive either a GR874 connector or a 274-MB double banana plug.

Versatility There is practically universal compatibility among the banana plugs and jacks in the 274-, 777-, and 938-series and adaptors such as 874-MB, -Q2, -Q10, and 900-Q9. Contact resistance, plug to jack, is typically about 1 mΩ.

Methods of Connection

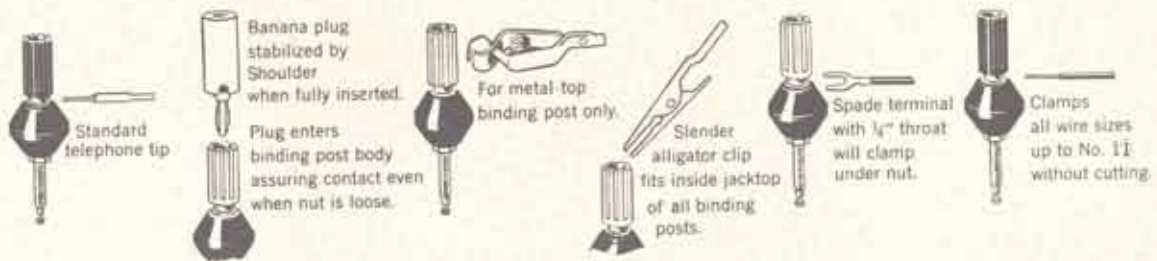

Mechanical Details

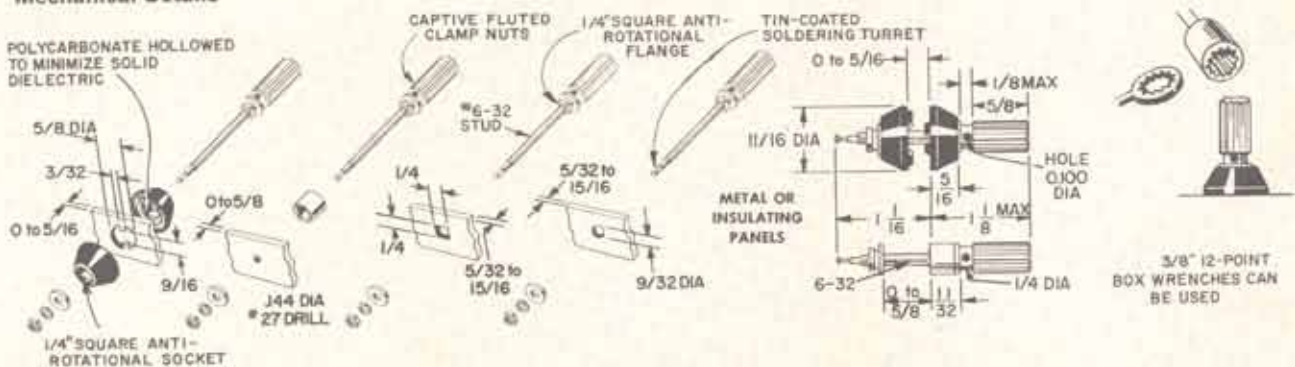

Locking keys in $\frac{3}{8}$ -inch mounting holes can be omitted if only moderate resistance to rotation is needed.

938 Binding Posts

Gold-Plated Copper Binding-Post Assembly

Three general types: With colored top for insulated finger grip, metal top for exterior clip-on connection, and uninsulated for panel (ground) connection. Refer to sketches for methods of connection. Gold-plated copper assures high conductivity and low thermal emf with copper wire. Jack top receives banana plug.

Peak Ratings: Up to 4 kV and 30 A. **BREAKDOWN:** 10 kV pk.
Dissipation Factor, at 1 kHz: < 0.0005.

Mechanical: **DIMENSIONS:** (see sketches). **NET WEIGHT:** colored top, 0.5 oz (14 g); metal top and uninsulated, 0.65 oz (18 g).

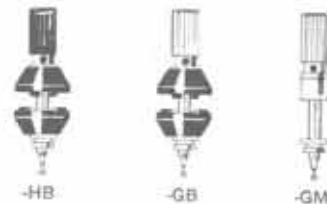

Description	Catalog Number
938 Binding-Post Assembly, Copper:	
938-HB with black top and insulators	0938-9852
938-KR with red top and insulators	0938-9855
938-GB with metal top, black insulators	0938-9842
938-GR with metal top, red insulators	0938-9845
938-GM uninsulated, with toothed spacer	0938-9834

Brass Binding-Post Assemblies

Nickel-plated brass, for strength and economy, otherwise like the gold-plated versions. Three general types: With colored tops for insulated finger grip, metal top for exterior clip-on connection, and uninsulated for panel (ground) connection.

Peak Ratings: Up to 4 kV and 30 A. **BREAKDOWN:** 10 kV pk.
Dissipation Factor, at 1 kHz: < 0.0005.

Mechanical: **DIMENSIONS:** (See sketches). **NET WEIGHT:** colored top, 0.4 oz (11 g); metal top and uninsulated, 0.5 oz (14 g).

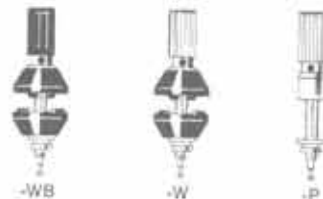

Description	Catalog Number
938 Binding-Post Assembly, Brass:	
938-WB with black top and insulators	0938-9872
938-WR with red top and insulators	0938-9882
938-W with metal top, black insulators	0938-9743
938-R with metal top, red insulators	0938-9728
938-P, uninsulated, with toothed spacer	0938-9727

Binding Posts

Jack-top binding posts, with top nuts for the primary clamping function, with mounting nuts and washers, but without panel insulators or toothed spacers. Gold-plated copper or nickel-plated brass.

Mechanical: **NET WEIGHT:** 938-A, -H, -K, 0.4 oz (11 g); -C, -D, 0.3g (9 g); -G, 0.55 oz (16 g).



Description	Catalog Number
938 Binding Posts:	
938-H Black top, copper	0938-9708
938-K Red top, copper	0938-9711
938-G Metal top, copper	0938-9707
938-C Black top, brass	0938-9733
938-D Red top, brass	0938-9734
938-A Metal top, brass	0938-9731

Binding-Post Accessories

Shorting link conveniently makes a direct short circuit between binding posts at standard spacing; remains semi-captive when swung around for open circuit. Panel insulators or toothed spacers convert any of the plain binding posts to insulated or uninsulated (panel-grounded) assemblies, respectively. Use insulators on both front and rear of panel, spacers on front only. Insulators have interdigitating bosses, for panels 0 to 0.32 (8 mm) thick. Double insulators hold pairs of binding posts at 0.75-in. (standard) spacing. Both insulators (polycarbonate) and spacers (brass) have square holes to prevent rotation of posts after assembly.

Mechanical: **NET WEIGHT:** 0.1 oz (3 g) each, except 938-BB and -BR, 0.1 oz per pair.



938 Accessories:	
938-LG Shorting link, gold-plated brass	0938-9503
938-L Shorting link, nickel-plated brass	0938-9712
938-BB Insulators, black, pair	0938-9818
938-BR Insulators, red, pair	0938-9822
938-YB Double insulators, pair	0938-9873
938-FG Spacer, (toothed) gold-plated	0938-9830
938-F Spacer, (toothed) nickel-plated	0938-9706

Banana Plugs and Jacks

Insulated Double Plug

Versatile Stackable, with jack top. Accommodates wires, cables, component leads, etc from either one side or top (up to 0.2-in. dia through formed strain relief). Metal parts float — although captive — for self alignment of mating plugs and jacks, at standard 0.75-in. spacing. Polarity indicator designates plug usually used for inner conductor, "high" side, or + polarity of the pair. Fully compatible with GR banana plugs and jacks, except 274-NK Shielded Double Plug.

Reliable Safety enhanced by enclosure of all metal parts but the banana pins themselves; even tips of wires are insulated. Rugged socket-head setscrews provide secure fastening for wires (without tendency to split like slotted screws). Low-loss molded styrene body.

Convertible Each banana pin is easily removable for conversion from side wiring to top wiring. Wire can be inserted and clamped with pin in place or removed, as you prefer. Use 0.078-in. hex wrench. Wire diameter up to 0.12 in. (3 mm or AWG 9) is accommodated.

Peak Ratings: Up to 4 kV and 15 A. **BREAKDOWN:** 10 kV pk.
Dissipation Factor, at 1 kHz: < 0.0005.
Net Weight: 0.4 oz (11 g).

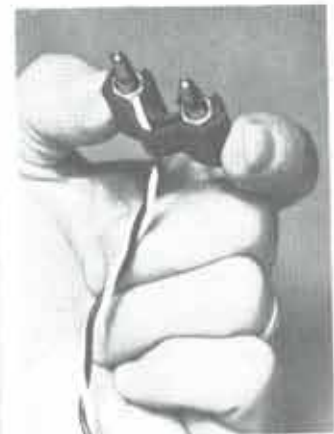
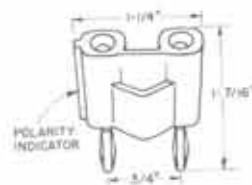

Description

Catalog Number

274-MB Insulated Double Plug

0274-9875

Shielded Double Plug

Double plug in an aluminum case for completely shielded connections to 938 Binding Posts. Accepts cables up to 0.2 in. diameter. Stepped case permits a 938-L(G) Shorting Link to be used between low-terminal binding post and a ground binding post without interfering with proper shielding. High terminal of double plug remains fully shielded. The 274-NK can be locked to binding posts; turning a screw expands one pin inside body of the binding post. This plug terminates the Type 274-NL, 776-A, and 874-R34 Patch Cords.

Peak Ratings: Up to 4 kV and 20 A. **BREAKDOWN:** 10 kV pk.
Dissipation Factor, at 1 kHz: < 0.0005.
Net Weight: 3 oz (85 g).



274-NK Shielded Double Plug

0274-9877

Single Plugs

Nickel-plated brass center pin with 4-leaf beryllium copper spring seats firmly in 274- and 938- series jacks for reliable contact, typically = 1 mΩ. All except 274-P have jack top. Insulated version is like half of double plug (274-MB); pin is removable; strain relief along side accepts wires up to 0.156-in. (4-mm) dia.

Current Rating: 15 A.
Net Weight: 274-P, -DB, 0.2 oz (5.5 g); -U, 0.3 oz (8.5 g).



-DB1

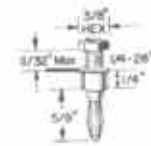

-U

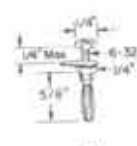

-P

274-Single Plugs

274-DB1 Insulated, black
274-DB2 Insulated, red
274-U Jack top
274-P Solid stud top

0274-9454
0274-9455
0274-9721
0274-9716

Jacks

Nickel-plated brass, for panel mounting. Two lengths, the longer is available as an assembly with insulators (938-BB, -BR) or can be used with separate toothed spacers (938-F, -FG). Mounting hardware supplied.

Current Rating: 15 A.
Net Weight: Assembly, 0.4 oz (11 g); long version 0.3 oz (8.5 g); short, 0.15 oz (4.2 g).

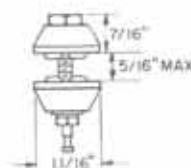

-XB

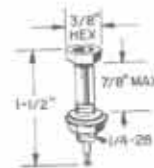

938-J



274-J

Jacks

938-XB Insulated assembly black
938-XR Insulated assembly, red
938-J Long jack
274-J Short jack

0938-9877
0938-9878
0938-9710
0274-9710

Adaptors

Refer also to the 874-MB and 874-Q series of adaptors.

GR874® Connector and Binding Posts

Connects to GR874 coaxial port from double (or 2 single) 274-series banana plug or patch cord. Has versatility of 938-series binding posts.

Net Weight: 2 oz (57 g).



Fits Type
274 Double-
Plug Patch Cords

Description

874-Q2 Adaptor

**Catalog
Number**

0874-9870

GR874® Connector and Banana Plugs

Connects to a standard-spaced pair of jack-top binding posts (938) from GR874® coaxial connector, with good shielding. Similar to 274-NK plug; can be locked to one post for semi-permanent installation, by a turn of a screw.

Net Weight: 2 oz (57 g).



777-Q3 Adaptor

0777-9703

BNC Jack and Banana Plugs

Connects BNC cable (plug) to standard pair of jack-top binding posts, with good shielding. Adaptor will lock to one post for semi-permanent installation, by a turn of a screw.

Net Weight: 3 oz (85 g).

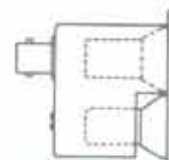

Fits standard
3/4-in.-spaced
binding posts

274-QBJ Adaptor

0274-9884

BNC Jack and Phone Plug

Connects BNC cable (plug) to phone jack.

Net Weight: 2 oz (57 g).



777-Q4 Adaptor

0777-9704

Patch Cords and Power Cords

(Refer also to the 874-R series of coaxial patch cords; they have superior SWR and other characteristics of value at high frequencies.)

Shielded Banana Plugs with Cable and BNC Plug

50- Ω cable connects between jack-top binding-post pair and BNC jack, with good shielding. Can be locked in place. (Refer to description of 274-NK Shielded Double Plug.)

Mechanical: LENGTH: 3 ft (920 mm). PLUG SPACING: 0.75 in., standard (19 mm). NET WEIGHT: 3 oz (85 g).



776-A Patch Cord

0776-9701

BNC Plug with Cable and GR874® Connector

50- Ω shielded cable connects between BNC jack and GR874 coaxial connector. The GR874 end has the space-saving hammerhead shape (axis perpendicular to cable), so convenient when your cable runs parallel to the instrument panel.

Mechanical: LENGTH: 3 ft. (920 mm). NET WEIGHT: 3 oz (85 g).



776-B Patch Cord

0776-9702

BNC Plugs with Cable

50- Ω shielded cable connects between BNC jacks (popular panel-mounted connectors).

Mechanical: LENGTH: 3 ft (920 mm). NET WEIGHT: 2 oz (57 g).



Shielded Double Banana Plugs with Cable

Fully shielded cable and connectors plug conveniently into pairs of 938 binding posts at standard spacing. Can be locked in place. (Refer to description of 274-NK Shielded Double Plug.)

Mechanical: LENGTH: 3 ft (920 mm). NET WEIGHT: 6 oz (170 g).



Banana Plugs with Cable

Shielded wire with double plugs is ideal for jack-top binding posts at standard spacing; single-conductor with single plugs fits any banana jack — 938- and 274-series, 874-Q2, -MB, etc. Right-angle (hammerhead), in-line, and single versions are stackable in any sequence. Plugs fit firmly in jacks for mechanical stability (not dependent on springs); contact resistance, about 1 m Ω . Double plugs have polarity indicator, corresponding to inner conductor of cable. Plug bodies are molded cellulose-acetate-butyrate for outstanding durability; the individual pins of the double plugs are, in addition, first encapsulated in polystyrene for superior insulation. Single versions, wire size: 18 AWG.

Mechanical: LENGTH: 3 ft (920 mm). NET WEIGHT: Double, 3 oz (85 g); single, 1.5 oz (43 g).

Description	Catalog Number
Banana-Plug Patch Cords	
274-NQ Double, in-line	0274-9860
274-NP Double, right-angle	0274-9880
274-LLB Single, black	0274-9468
274-LLR Single, red	0274-9492

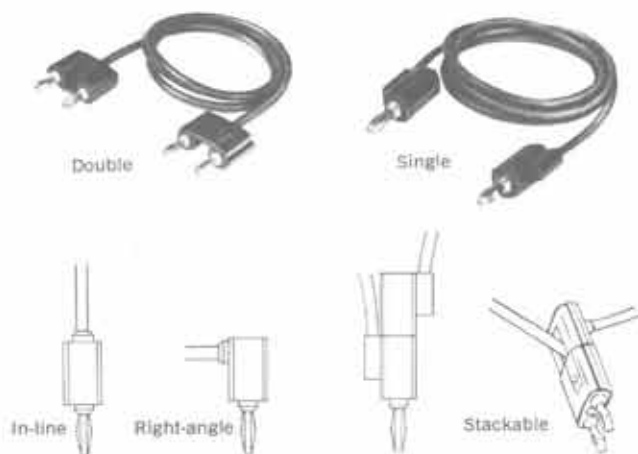

Power Cords

Well insulated power cable has connector bodies molded integrally with jacket. Will connect from standard power-line outlet to instrument or other electrical device. Similar cables can be stacked with their hammerheads engaged (to accommodate several loads); 2 or more CAP-22 or CAP-35 cords can be connected in series to reach 14 ft or more. Both 2- and 3-wire versions. Socket at load end of 2-wire version fits either 2-pin plug or 2 flat pins of CAP-22.

3-wire versions At power-source end, these cords have 1 round and 2 flat pins, as well as the corresponding socket. This connector is designed for 125-V operation, conforming to the standard for "Grounding Type Attachment Plug Caps and Receptacles," ANSI C73.11-1963. Cord is type SVT, rated by Underwriters Laboratories for 300 V, 7 A rms. At the load end, CAP-22 has a similar socket, permitting series connection.

International At the load end of the IEC version, however, the socket fits 3 flat pins, conforming to the International Electrotechnical Commission's Publication 320. The design has been adopted world-wide for electronic instrumentation and is rated for 250 V, 6 A. Other advantages are convenience and safety (the instrument plug is recessed or shrouded).

For special requirements, you can cut off the hammerhead connector and replace it with your own.

Ratings: 125 V, 7 A. **WIRE SIZE:** No. 18 AWG.
Mechanical: LENGTH: 7 ft (2.13 m). NET WEIGHT: 7 oz (0.2 kg).



970-Series Potentiometers

These potentiometers are moderately priced controls with high-quality performance. They can be used at dc, throughout the audio- and ultrasonic-frequency ranges, and, in many applications, at low radio frequencies. When ganged, the 970-Series Potentiometers retain their low-

capacitance characteristics. Units are designed to be nested with molded spacing rings, stacked on a long shaft, and held together with thin metal clamping rings and tie rods. This assembly allows units to be set in any desired phase relationship.

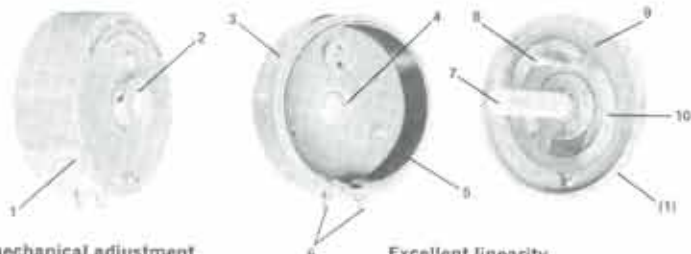

Simple mechanical adjustment Excellent mechanical stability Excellent Repeatability

Projecting hub permits adjustment of shaft with respect to contact brush while case is closed. Hub rotates in a recessed brass insert molded into cover to form a metal-to-metal bearing close to plane of brush.

A second bearing is provided by a nylon-graphite insert to guide shaft in to base.

Excellent linearity Low temperature coefficient Low inductance

Uniformly wound, low-temperature-coefficient resistance element on a thin, phenolic-laminate mandrel firmly cemented into body molding.

Low noise

Firm clean track
Precious-metal contact
Uniform contact pressure

High leakage resistance Low capacitance to ground

Glass-reinforced-polyester shaft
New diallyl-orththalate dust-proof cover
New diallyl-phthalate body

High resolution





Small-diameter brush of precious-metal alloy

High reliability

Turret terminals are both riveted to end of clamps and soldered to ends of winding and to silver-plated, spring-bronze contact take-off in cover so that none of the fixed internal connections depends on pressure alone.

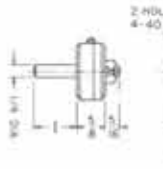
Brush arm and spring are combined into a single stamping of spring-temper phosphor-bronze.

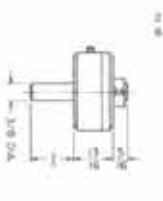
Screw that holds cover to base passes through a horseshoe-shaped slot in brush arm to serve as a rotational stop that exerts no force on brush.

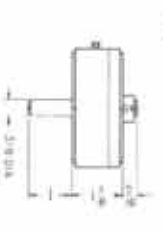
(All dimensions in inches)		Type	Nominal Resistance Ohms	Temperature Coefficient of Resistance	Resolution	Catalog Number
  Wt: Approx 1/2 oz (14 g)	971-B	2	±0.07%	<1%	0971-9702	
	971-C	5	±0.07	<1	0971-9703	
	971-D	10	±0.002	<1	0971-9704	
	971-E	20	±0.002	<1	0971-9705	
	971-F	50	±0.002	<0.5	0971-9706	
	971-G	100	±0.002	<0.5	0971-9707	
	971-H	200	±0.002	<0.5	0971-9708	
	971-J	500	±0.002	<0.5	0971-9710	
	971-K	1000	±0.002	<0.5	0971-9711	
	971-L	2000	±0.002	<0.5	0971-9712	
	971-M	5000	±0.002	<0.2	0971-9713	
	971-N	10,000	±0.002	<0.2	0971-9714	
	971-P	20,000	±0.002	<0.2	0971-9716	
  Wt: Approx 1 oz (28 g)	973-C	5	±0.07	<0.5	0973-9703	
	973-D	10	±0.07	<0.5	0973-9704	
	973-E	20	±0.002	<0.5	0973-9705	
	973-F	50	±0.002	<0.5	0973-9706	
	973-G	100	±0.002	<0.5	0973-9707	
	973-H	200	±0.002	<0.5	0973-9708	
	973-J	500	±0.002	<0.2	0973-9710	
	973-K	1000	±0.002	<0.2	0973-9711	
	973-L	2000	±0.002	<0.2	0973-9712	
	973-M	5000	±0.002	<0.2	0973-9713	
  Wt: Approx 3 oz (85 g)	975-J	500	±0.002	<0.2	0975-9710	
	975-K	1000	±0.002	<0.2	0975-9711	
	975-L	2000	±0.002	<0.2	0975-9712	
	975-M	5000	±0.002	<0.2	0975-9713	
	975-N	10,000	±0.002	<0.1	0975-9714	
	975-P	20,000	±0.002	<0.1	0975-9716	
	975-Q	50,000	±0.002	<0.05	0975-9717	
	975-R	100,000	±0.002	<0.05	0975-9718	

Type	Effective Electrical Rotation	Total Mechanical Rotation	Standard Resistance Tolerance	Average Torque oz./in.	Independent Linearity	Power Rating at 0°C ambient temp*	
						Mounted on Alum. Panel	Suspended in Air
971	315° ± 5°	330° ± 5°	±5%	1.8	±2%	5.6 W	3.5 W
973	320° ± 5°	330° ± 5°	±5%	2.5	±1%	8.4 W	5.9 W
975	320° ± 2°	330° ± 5°	±2%	4	±0.5%	13.4 W	10.7 W

* Power rating decreases linearly with rising ambient temperature to zero at 100°C.

⊕ Federal stock numbers are listed before the index.



Types 1218-BV and 1267 shown rack-mounted with 0481-9846 Rack-Adaptor Set.

Rack Adaptors and Sets

Listed below are the instrument-panel extensions and hardware, supplied in complete sets, for converting bench-model instruments for mounting in standard 19-inch relay racks. In many cases, these instruments are offered in a choice of rack or bench mountings and should be ordered initially according to mounting requirements, as complete cabinets and hardware are included. When

retrofitting is necessary, the adaptors below should be ordered.

Instruments missing from this list may require more extensive changes than can be done by simple kits or may be unavailable for rack mounting other than by special order. In these cases, a General Radio Regional Center or representative should be consulted.

Instrument	Height (in.)	Catalog Number
1157-B	3½	0480-9722
1192	3½	0480-9722
1192-Z	3½	0480-9702
1192 + 1157-B	3½	0480-9702
1211-C	7	0480-9848
1211-C + 1263 or 1264	7	0481-9846
1211-C + 1267 or 1269	7	0481-9842
1215-C	7	same as 1211's
1217-C	7	0480-9986
1218-BV	7	0481-9842
1218-BV + 1263 or 1264	14	0482-9842
1218-BV + 1267	7	0481-9846
1232-A	5¼	0480-9838
1232-A + 1311	5¼	0480-9836
1232-A + 1232-P1 + 1311	5¼	0480-9837
1236	7	0480-9848
1236 with oscillator		see 1241's
1240-A	5¼	0480-9836
1240-AP	5¼	0480-9837
1241-9701, 1241-9703	7	0480-9670
1241-9705	14	0480-9671 and -9848

Instrument	Height (in.)	Catalog Number
1263	7	0480-9848
1264	7	0480-9848
1309-A	5¼	0480-9838
1310-B	5¼	0480-9838
1311	5¼	0480-9838
1311 + 1232-A	5¼	0480-9836
1311 + 1232-A + 1232-P1	5¼	0480-9837
1340	5¼	0480-9723
1361-A	7	same as 1211's
1362	7	same as 1211's
1363	7	same as 1211's
1381	3½	0480-9722
1382	3½	0480-9722
1390-B	7	0480-9842
1396-B	5¼	0480-9723
1413	5¼	0480-9703
1433 4-dial	3½	0480-2080
5-dial	3½	0480-2060
6-dial	3½	0480-2020
7-dial	5¼	0480-2091
1436	3½	0480-9722
1455 4-dial	3½	0480-2060
5-dial	3½	0480-2020
1491	8¼	0480-9705
1560-P62	3½	0480-9742
1840-A	3½	0480-9822

Cabinets and Mounting

General Radio instrument cabinets are rugged, attractive, and versatile. Heavy-gauge aluminum and tough finishes combine to keep GR instruments operating and looking like new through many years of hard service.

We use five basic cabinet types: (1) Pedestal cabinets, for bench mounting of instruments with a standard 19-

inch-wide panel, (2) rack cabinets, for installation in standard racks, (3) Flip-Tilt cases*, for portable instruments, (4) convertible-bench cabinets, for smaller laboratory instruments, and (5) lab-bench cabinets, for laboratory standards, decade boxes, and similar instruments.

* Patent Number 2,966,257.

Rack or Bench Instruments

General Radio instruments with 19-inch-wide front panels are supplied in a choice of mounting for either relay-rack installation or for use on a bench where portability counts. All cabinets, whether for rack or bench use, are effective shields preventing mutual interference with other nearby instruments.

Newer instrument models are mounted in either a "pedestal" cabinet for bench use or a "rack" cabinet, each specifically designed for its particular function. The pedestal cabinet raises the instrument slightly on a recessed pedestal that provides a handhold for lifting. In smaller instruments, the pedestal is the base for a tilting mechanism and, inside, provides storage space for instruction manuals and small accessories. For convenient

carrying, larger instruments and assemblies in the pedestal cabinet have hinged heavy-duty handles recessed into the sides near the top of the cabinet. Slides in both pedestal and rack cabinets permit easy removal for servicing. The rack cabinet has all the provisions for mounting the instrument in a standard 19-inch relay rack with universal mounting-hole spacing per EIA Standard RS-310 and includes rear-support brackets as well.

Flip-Tilt Cases

General Radio's exclusive Flip-Tilt case includes three main parts: the instrument cabinet, a captive cover, and a carrying-handle and lever assembly. In use, the instrument sits on its cover as a base. To open the cabinet, you push down on the carrying handle. The lever action of the handle raises the cabinet from the cover. The cabinet

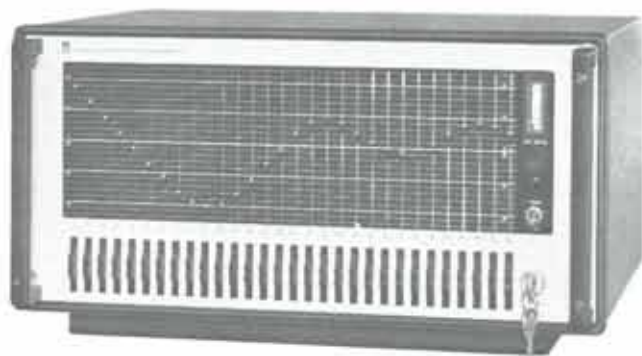

Pedestal Cabinet



Rack Cabinet



Flip-Tilt case in one of its many operating positions. Rubber gasket provides friction to allow almost any tilt angle.

is then easily flipped into position for operation. The operating position may be fully open or tilted at almost any angle. A rubber seal around the edge of the cover provides friction to hold the cabinet in a tilted position. When the instrument is closed, the same gasket provides a seal for the enclosure. Accessories and instruction manual are conveniently stored in the Flip-Tilt cover.

Certain Flip-Tilt instruments are also available in standard relay-rack cabinets; most other Flip-Tilt instruments are available adapted for rack mounting. In such adaptations, the Flip-Tilt case (minus cover and handle) is neatly and securely mounted in a relay-rack adaptor panel.

Convertible-Bench Cabinets

Small and medium-sized instruments commonly used on the bench are housed in GR's unique convertible-bench cabinet, designed primarily for the bench but offering quick relay-rack adaptability.

The convertible-bench cabinet is made of sturdy aluminum finished in GR medium gray wrinkle. The dust cover can be readily removed.

Instruments with panel meters can be tilted to a convenient angle.

Conversion for relay-rack mounting is easy: simply attach matching panel extensions by means of screws to the instrument and to the relay rack.



Convertible-bench instruments tilt on extendible balls for easy viewing of front panels. Panel extensions are used for rack mount.

Lab-Bench Cabinets

Lab-bench cabinets are simple enclosures used primarily for laboratory standards and decade boxes. Two U-shaped pieces of $\frac{1}{8}$ -inch extruded aluminum are strip-locked together to form the sides; an aluminum bottom plate and $\frac{1}{4}$ -inch aluminum panel complete the enclosure. The result is a cabinet well shielded, structurally solid, and efficiently manufactured.

Other Cabinets

While most General Radio instruments are housed in the five cabinets described above, several other types of mounting are used to serve the special demands of particular instruments. These range from the pocket-sized cases used for certain portable sound-measuring instruments to the specialized structures of a slotted line or an admittance meter.

Accessory mounting hardware, such as end frames, relay-rack supports, and relay-rack adaptor panels, may be ordered separately if you wish to convert from one type of mounting to another. Many of these accessories are listed along with the related instruments; there is a catalog page listing rack adaptors. Further information on such hardware, dimensions, etc. is available on request.



This precision capacitor is given the excellent shielding and trim appearance of the lab-bench cabinet, characterized by the strip-locked sides (as shown at the right in the photograph).

Definitions of Mechanical Specifications

Dimensions

All dimensions are over-all, except depth of rack models, and are given in decimal inches and millimeters (1 in. = 25.4 mm).

Bench Instruments

Width: Includes panel and cabinet.

Height: Includes pedestal or feet.

Depth: Includes any protrusions on front and rear panels. Does *not* include cable clearance (usually about 3 in. or 77 mm).

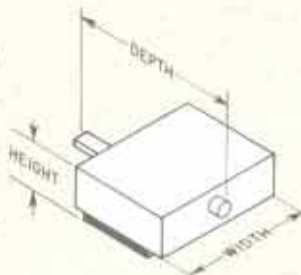

Portable Instruments

Width: Case closed; includes handle or other protrusions.

Height: Includes handle and feet, if any.

Depth: Over-all.

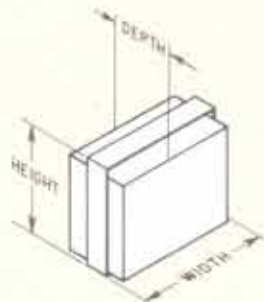

Rack Instruments

Width: Includes front panel only.

Height: Includes front panel only.

Depth: Behind rear surface of front panel; includes any protrusions on rear panel but does *not* include cable radii (usually about 3 in. or 77 mm), nor any protrusions on front panel.

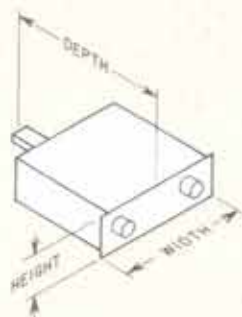

Unusual Shapes

All dimensions are maximum, including any protrusions, but *excluding* cords or cables.

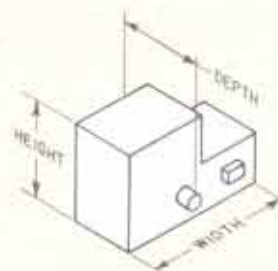
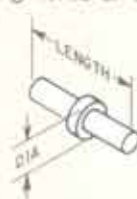

Weight

All weights are in ounces or pounds and grams or kilograms (1 oz = 28.35 g; 1 lb = 0.454 kg).

Net Weight: Net weight includes the weight of the instrument and its cabinet, including any rack-mounting hardware. Where options are listed for an instrument, the net weight is the weight for an instrument containing the heaviest combination of options.

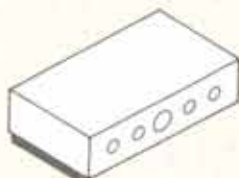

Shipping Weight: Shipping weight includes the net weight of the instrument plus the weight of all accessories supplied, power cord (if any), and packing materials required for shipment in the U. S. and Canada.

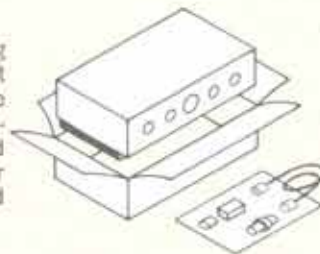

Reactance Chart

Always use corresponding scales

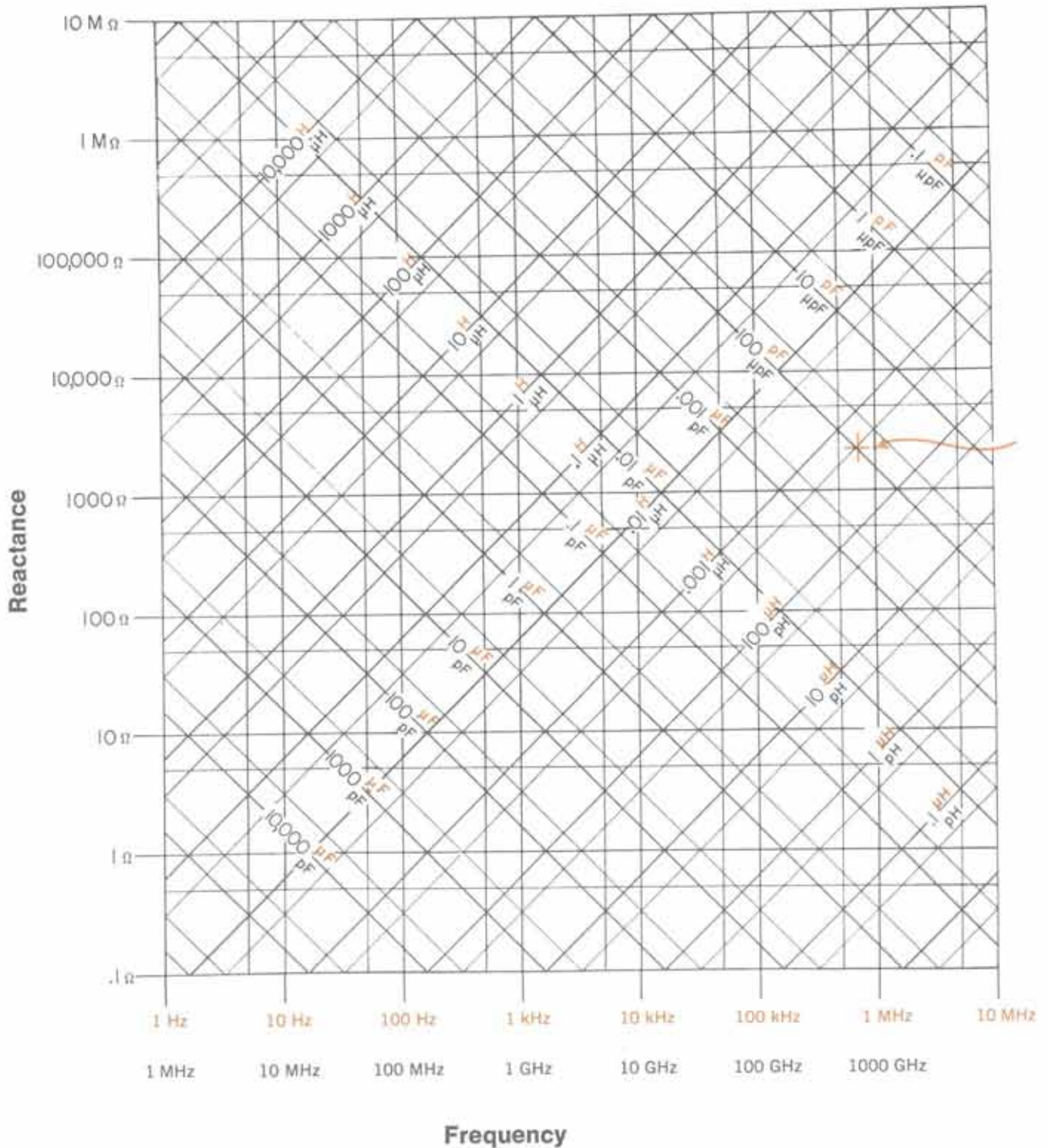

FIGURE 1

Figure 1 is the complete chart, used for rough calculations. Figure 2, which is a single decade of Figure 1 enlarged approximately 7 times, is used where two or three significant figures are to be determined.

To Find Reactance

Enter the charts vertically from the bottom (frequency) and along the lines slanting upward to the left (capacitance) or to the right (inductance). Corresponding scales (color or

black) must be used throughout. Project horizontally to the left from the intersection and read reactance.

To Find Resonant Frequency

Enter the slanting lines for the given inductance and capacitance. Project downward and read resonant frequency from the bottom scale. **Corresponding scales (color or black) must be used throughout.**

Reactance Chart

Always obtain approximate value from Figure 1 before using Figure 2

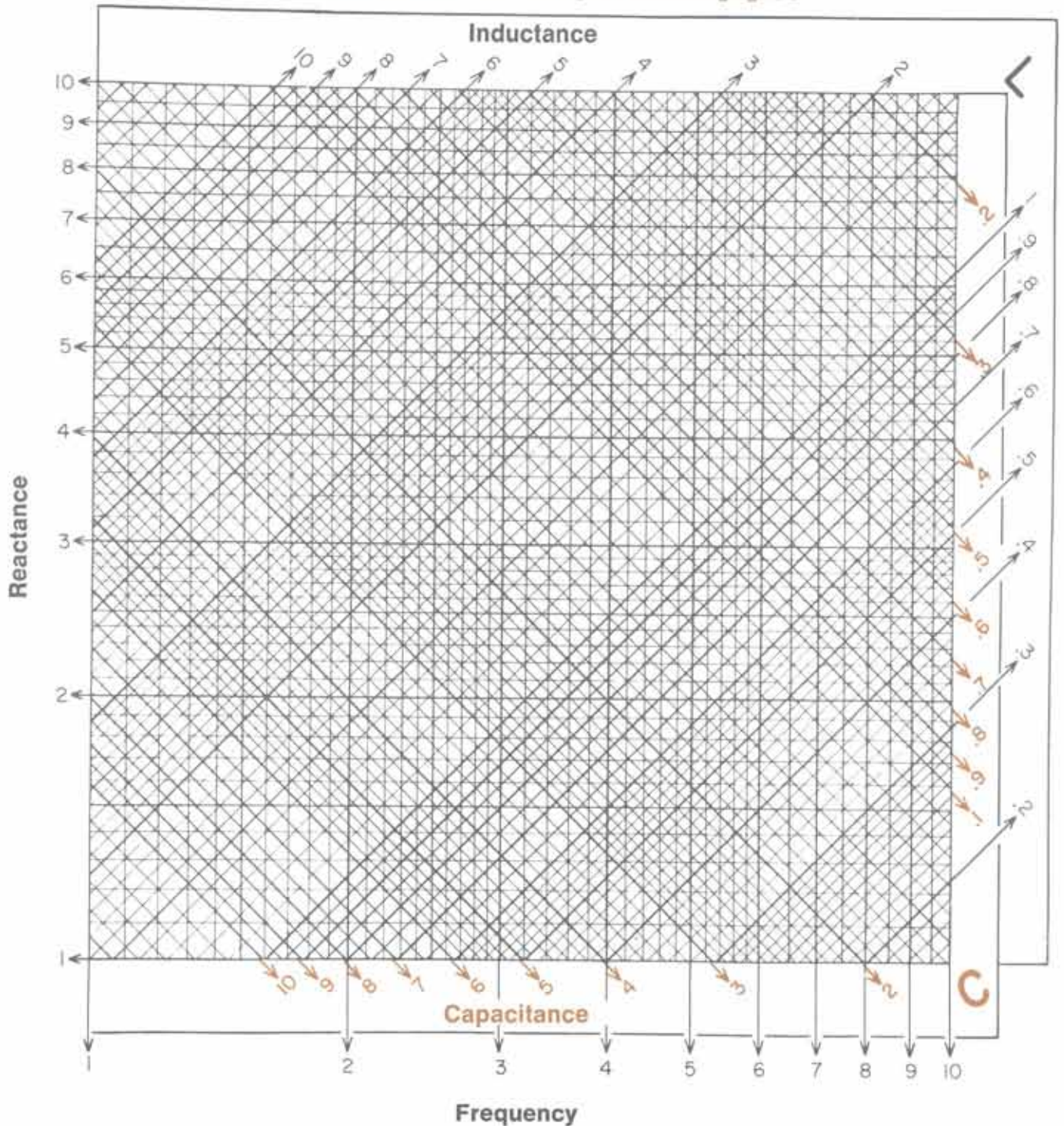

FIGURE 2

Example: The point indicated in Figure 1 corresponds to a frequency of about 700 kHz and an inductance of 500 μH , or a capacitance of 100 pF, giving in either case a reactance of about 2000 ohms. The resonant frequency of a circuit containing these values of inductance and capacitance is, of course, 700 kHz, approximately.

Use of Figure 2

Figure 2 gives additional precision but does not place the decimal point, which must be located from a preliminary entry on Figure 1. Since the chart necessarily requires two logar-

ithmic decades for inductance and capacitance for every single decade of frequency and reactance, unless the correct decade for L and C is chosen, the calculated values of reactance and frequency will be in error by a factor of 3.16. In Figure 2, the capacitance scale is color; inductance scale is black.

Example: (Continued) The reactance corresponding to 500 μH or 100 pF is 2230 ohms at 712 kHz, their resonant frequency.

Abbreviations, Symbols and Prefixes

In this catalog, as in other General Radio publications, our use of symbols, prefixes, and abbreviations follows the recommendations of the International Electrotechnical Commission, the American National Standards Institute, Inc., the Institute of Electrical and Electronics Engineers, and other scientific and engineering organizations. Where there is not agreement among these groups, we generally choose the usage favored by the majority.

ABBREVIATIONS AND SYMBOLS

a	atto (10^{-18})	h _o	open-circuit output admittance
A	ampere	h _r	reverse voltage-transfer ratio
Å	angstrom	Hz	hertz (cycle per second)
ac	alternating current	HTL	hearing threshold level
afc	automatic frequency control	I	current
a-m	amplitude modulation	IC	integrated circuit
ANSI	American National Standards Institute, Inc.	ID	inside diameter
APS	American Physical Society	IEC	International Electrotechnical Commission
ASA	Acoustical Society of America	IEEE	Institute of Electrical and Electronics Engineers
ASTM	American Society for Testing and Materials	i-f	intermediate frequency
avc	automatic volume control	in.	inch
ave	average	ISA	Instrument Society of America
B	susceptance	ISO	International Standards Organization
bar	bar (10^5N/m^2)	J	$\sqrt{-1}$
BCD	binary-coded decimal	J	joule
c	speed of light, centi (10^{-2})	k	kilo (10^3)
C	capacitance, coulomb	°K	degrees Kelvin
°C	degrees Celsius (Centigrade)	l	liter (10^{-3}m^3)
cd	candela	L	inductance
CIF	cost, insurance, freight	lb	pound
CML	current-mode logic	LC	inductance-capacitance
COD	cash on delivery	lm	lumen
cw	continuous wave	log	logarithm
d	deci (10^{-1})	lx	lux
D	dissipation factor	m	meter, milli (10^{-3})
da	deka (10)	M	mega (10^6)
dB	decibel	max	maximum
dBm	decibel referred to one milliwatt	mbar	millibar
dc	direct current	mil	0.001 inch
DCTL	direct-coupled transistor logic	min	minimum, minute
dia	diameter	mo	month
DTL	diode-transistor logic	n	nano (10^{-9})
DUT	device under test	N	newton
e	electronic charge	oz	ounce
E	voltage	p	page, parallel (as L _p), pico (10^{-12})
EIA	Electronic Industries Association	P	poise ($10^{-1} \text{N} \cdot \text{s/m}^2$)
emf	electromotive force	PF	power factor
F	farad, Faraday	ppm	parts per million
°F	degrees Fahrenheit	pps	pulses per second
f	frequency, femto (10^{-15})	pk-pk	peak-to-peak
fm	frequency modulation	PRF	pulse repetition frequency
FOB	free on board	Q	quality factor (storage factor)
G	conductance, giga (10^9)	R	resistance
g	gram, gravitational constant	®	registered trademark
g _m	transconductance	rad	radian
H	henry	RC	resistance-capacitance
h	hour, Planck's constant, hecto (10^2)	RCTL	resistor-capacitor-transistor logic
hf	high frequency	re	referred to
h _i	forward current-transfer ratio	rf	radio frequency
h _o	short-circuit input impedance	RH	relative humidity
		rms	root-mean-square

rpm	revolutions per minute
RTL	resistor-transistor logic
s	second, series (as L _s)
shf	super-high frequency
sq	square
sync	synchronous, synchronizing
T	period, Tesla, tera (10^{12})
t	time
TTL	transistor-transistor logic
TSA	times series analysis
uhf	ultra-high frequency
v	velocity
V	volt
VA	volt ampere
vhf	very-high frequency
vlf	very-low frequency
W	watt
Wb	Weber
wt	weight
X	reactance
Y	admittance
yr	year
Z	impedance
α	short-circuit forward current-transfer ratio (common base)
β	short-circuit forward current-transfer ratio (common emitter)
Γ	reflection coefficient
Δ	increment
δ	loss angle
θ	phase angle
λ	wavelength
μ	micro (10^{-6})
Ω	ohm
⊘	mho
ω	angular velocity (2πf)

PREFIXES

Orders of magnitude from 10^{-18} to 10^{12} are designated by the following prefixes:

Order	Prefix	Symbol
10^{12}	tera	T
10^9	giga	G
10^6	mega	M
10^3	kilo	k
10^2	hecto	h
10	deka	da
10^{-1}	deci	d
10^{-2}	centi	c
10^{-3}	milli	m
10^{-6}	micro	μ
10^{-9}	nano	n
10^{-12}	pico	p
10^{-15}	femto	f
10^{-18}	atto	a

Decibel Conversion Tables

In communications systems the ratio between any two amounts of electric or acoustic power is usually expressed in units on a logarithmic scale. The decibel (1/10th of the bel) on the briggisian or base-10 scale and the neper on the napierian or base-e scale are in almost universal use for this purpose.

Since voltage and current are related to power by impedance, both the decibel and the neper can be used to express voltage and current ratios, if care is taken to account for the impedances associated with them. In a similar manner the corresponding acoustical quantities can be compared.

From Table I and Table II on the following pages conversions can be made in either direction between the number of decibels and the corresponding power, voltage, and current ratios. Both tables can also be used for nepers by application of a conversion factor.

Decibel — The number of decibels N_{db} corresponding to the ratio between two amounts of power P_1 and P_2 is

$$N_{db} = 10 \log_{10} \frac{P_1}{P_2}$$

When two voltages E_1 and E_2 or two currents I_1 and I_2 operate in identical impedances,

$$N_{db} = 20 \log_{10} \frac{E_1}{E_2} \quad \text{and} \quad N_{db} = 20 \log_{10} \frac{I_1}{I_2}$$

If E_1 and E_2 and I_1 and I_2 operate in unequal impedances,

$$N_{db} = 20 \log_{10} \frac{E_1}{E_2} + 10 \log_{10} \frac{Z_2}{Z_1} + 10 \log_{10} \frac{k_1}{k_2}$$

$$\text{and} \quad N_{db} = 20 \log_{10} \frac{I_1}{I_2} + 10 \log_{10} \frac{Z_1}{Z_2} + 10 \log_{10} \frac{k_1}{k_2}$$

where Z_1 and Z_2 are the absolute magnitudes of the corresponding impedances and k_1 and k_2 are the values of power factor for the impedances. E_1 , E_2 , I_1 , and I_2 are also the absolute magnitudes of the corresponding quantities. Note that Table I and Table II can be used to evaluate the impedance and power factor terms, since both are similar to the expression for power ratio.

Neper — The number of nepers N_{nep} corresponding to a power ratio $\frac{P_1}{P_2}$ is

$$N_{nep} = \frac{1}{2} \log_e \frac{P_1}{P_2}$$

For voltage ratios $\frac{E_1}{E_2}$ or current ratios $\frac{I_1}{I_2}$ working in identical impedances,

$$N_{nep} = \log_e \frac{E_1}{E_2} \quad \text{and} \quad N_{nep} = \log_e \frac{I_1}{I_2}$$

Relations Between Decibels and Nepers

Multiply decibels by 0.1151 to find nepers

multiply nepers by 8.686 to find decibels

TO FIND VALUES OUTSIDE THE RANGE OF CONVERSION TABLES

Table I: Decibels to Voltage and Power Ratios

Number of decibels positive (+): Subtract +20 decibels successively from the given number of decibels until the remainder falls within range of Table I. To find the voltage ratio, multiply the corresponding value from the right-hand voltage-ratio column by 10 for each time you subtracted 20 dB. To find the power ratio, multiply the corresponding value from the right-hand power-ratio column by 100 for each time you subtracted 20 dB.

Example — Given: 49.2 dB

$$49.2 \text{ dB} - 20 \text{ dB} - 20 \text{ dB} = 9.2 \text{ dB}$$

$$\text{Voltage ratio: } 9.2 \text{ dB} \rightarrow 2.884$$

$$2.884 \times 10 \times 10 = 288.4$$

$$\text{Power ratio: } 9.2 \text{ dB} \rightarrow 8.318$$

$$8.318 \times 100 \times 100 = 83180$$

Number of decibels negative (—): Add +20 decibels successively to the given number of decibels until the sum falls within the range of Table I. For the voltage ratio, divide the value from the left-hand voltage-ratio column by 10 for each time you added 20 dB. For the power ratio, divide the value from the left-hand power-ratio column by 100 for each time you added 20 dB.

Example — Given: -49.2 dB

$$+49.2 \text{ dB} + 20 \text{ dB} + 20 \text{ dB} = -9.2 \text{ dB}$$

$$\text{Voltage ratio: } -9.2 \text{ dB} \rightarrow 0.3467$$

$$0.3467 \times 1/10 \times 1/10 = 0.003467$$

$$\text{Power ratio: } -9.2 \text{ dB} \rightarrow 0.1202$$

$$0.1202 \times 1/100 \times 1/100 = 0.00001202$$

Table II: Voltage Ratios to Decibels

For ratios smaller than those in table — Multiply the given ratio by 10 successively until the product can be found in the table. From the number of decibels thus found, subtract +20 decibels for each time you multiplied by 10.

Example — Given: Voltage ratio = 0.0131

$$0.0131 \times 10 \times 10 = 1.31$$

$$\text{From Table II, } 1.31 \rightarrow 2.345 \text{ dB}$$

$$2.345 \text{ dB} - 20 \text{ dB} - 20 \text{ dB} = -37.655 \text{ dB}$$

For ratios greater than those in table — Divide the given ratio by 10 successively until the remainder can be found in the table. To the number of decibels thus found, add +20 dB for each time you divided by 10.

Example — Given: Voltage ratio = 712

$$712 \times 1/10 \times 1/10 = 7.12$$

$$\text{From Table II, } 7.12 \rightarrow 17.050 \text{ dB}$$

$$17.050 \text{ dB} + 20 \text{ dB} + 20 \text{ dB} = 57.050 \text{ dB}$$

GIVEN: Decibels

Table I TO FIND: Power and $\left\{ \begin{matrix} \text{Voltage} \\ \text{Current} \end{matrix} \right\}$ Ratios

TO ACCOUNT FOR THE SIGN OF THE DECIBEL

For positive (+) values of the decibel — Both voltage and power ratios are greater than unity. Use the two right-hand columns.

For negative (-) values of the decibel — Both voltage and power ratios are less than unity. Use the two left-hand columns.

Example—Given: ± 9.1 dB; Find:

	Power Ratio	Voltage Ratio
+9.1 dB	8.128	2.851
-9.1 dB	0.1230	0.3508

← -dB+ →					← -dB+ →				
Voltage Ratio	Power Ratio	dB	Voltage Ratio	Power Ratio	Voltage Ratio	Power Ratio	dB	Voltage Ratio	Power Ratio
1.0000	1.0000	0	1.000	1.000	.5623	.3162	5.0	1.778	3.162
.9886	.9772	.1	1.012	1.023	.5559	.3090	5.1	1.799	3.236
.9772	.9550	.2	1.023	1.047	.5495	.3020	5.2	1.820	3.311
.9661	.9333	.3	1.035	1.072	.5433	.2951	5.3	1.841	3.388
.9550	.9120	.4	1.047	1.096	.5370	.2884	5.4	1.862	3.467
.9441	.8913	.5	1.059	1.122	.5309	.2818	5.5	1.884	3.548
.9333	.8710	.6	1.072	1.148	.5248	.2754	5.6	1.905	3.631
.9226	.8511	.7	1.084	1.175	.5188	.2692	5.7	1.928	3.715
.9120	.8318	.8	1.096	1.202	.5129	.2630	5.8	1.950	3.802
.9016	.8128	.9	1.109	1.230	.5070	.2570	5.9	1.972	3.890
.8913	.7943	1.0	1.122	1.259	.5012	.2512	6.0	1.995	3.981
.8810	.7762	1.1	1.135	1.288	.4955	.2455	6.1	2.018	4.074
.8710	.7586	1.2	1.148	1.318	.4898	.2399	6.2	2.042	4.169
.8610	.7413	1.3	1.161	1.349	.4842	.2344	6.3	2.065	4.266
.8511	.7244	1.4	1.175	1.380	.4786	.2291	6.4	2.089	4.365
.8414	.7079	1.5	1.189	1.413	.4732	.2239	6.5	2.113	4.467
.8318	.6918	1.6	1.202	1.445	.4677	.2188	6.6	2.138	4.571
.8222	.6761	1.7	1.216	1.479	.4624	.2138	6.7	2.163	4.677
.8128	.6607	1.8	1.230	1.514	.4571	.2089	6.8	2.188	4.786
.8035	.6457	1.9	1.245	1.549	.4519	.2042	6.9	2.213	4.898
.7943	.6310	2.0	1.259	1.585	.4467	.1995	7.0	2.239	5.012
.7852	.6166	2.1	1.274	1.622	.4416	.1950	7.1	2.265	5.129
.7762	.6026	2.2	1.288	1.660	.4365	.1905	7.2	2.291	5.248
.7674	.5888	2.3	1.303	1.698	.4315	.1862	7.3	2.317	5.370
.7586	.5754	2.4	1.318	1.738	.4266	.1820	7.4	2.344	5.495
.7499	.5623	2.5	1.334	1.778	.4217	.1778	7.5	2.371	5.623
.7413	.5495	2.6	1.349	1.820	.4169	.1738	7.6	2.399	5.754
.7328	.5370	2.7	1.365	1.862	.4121	.1698	7.7	2.427	5.888
.7244	.5248	2.8	1.380	1.905	.4074	.1660	7.8	2.455	6.026
.7161	.5129	2.9	1.396	1.950	.4027	.1622	7.9	2.483	6.166
.7079	.5012	3.0	1.413	1.995	.3981	.1585	8.0	2.512	6.310
.6998	.4898	3.1	1.429	2.042	.3936	.1549	8.1	2.541	6.457
.6918	.4786	3.2	1.445	2.089	.3890	.1514	8.2	2.570	6.607
.6839	.4677	3.3	1.462	2.138	.3846	.1479	8.3	2.600	6.761
.6761	.4571	3.4	1.479	2.188	.3802	.1445	8.4	2.630	6.918
.6683	.4467	3.5	1.496	2.239	.3758	.1413	8.5	2.661	7.079
.6607	.4365	3.6	1.514	2.291	.3715	.1380	8.6	2.692	7.244
.6531	.4266	3.7	1.531	2.344	.3673	.1349	8.7	2.723	7.413
.6457	.4169	3.8	1.549	2.399	.3631	.1318	8.8	2.754	7.586
.6383	.4074	3.9	1.567	2.455	.3589	.1288	8.9	2.786	7.762
.6310	.3981	4.0	1.585	2.512	.3548	.1259	9.0	2.818	7.943
.6237	.3890	4.1	1.603	2.570	.3508	.1230	9.1	2.851	8.128
.6166	.3802	4.2	1.622	2.630	.3467	.1202	9.2	2.884	8.318
.6095	.3715	4.3	1.641	2.692	.3428	.1175	9.3	2.917	8.511
.6026	.3631	4.4	1.660	2.754	.3388	.1148	9.4	2.951	8.710
.5957	.3548	4.5	1.679	2.818	.3350	.1122	9.5	2.985	8.913
.5888	.3467	4.6	1.698	2.884	.3311	.1096	9.6	3.020	9.120
.5821	.3388	4.7	1.718	2.951	.3273	.1072	9.7	3.055	9.333
.5754	.3311	4.8	1.738	3.020	.3236	.1047	9.8	3.090	9.550
.5689	.3236	4.9	1.758	3.090	.3199	.1023	9.9	3.126	9.772

Table I (continued)

← dB →					← dB →				
Voltage Ratio	Power Ratio	dB	Voltage Ratio	Power Ratio	Voltage Ratio	Power Ratio	dB	Voltage Ratio	Power Ratio
.3162	.1000	10.0	3.162	10.000	.1585	.02512	16.0	6.310	39.81
.3120	.09772	10.1	3.199	10.23	.1567	.02455	16.1	6.383	40.74
.3090	.09550	10.2	3.236	10.47	.1549	.02399	16.2	6.457	41.69
.3055	.09333	10.3	3.273	10.72	.1531	.02344	16.3	6.531	42.66
.3020	.09120	10.4	3.311	10.96	.1514	.02291	16.4	6.607	43.65
.2985	.08913	10.5	3.350	11.22	.1496	.02239	16.5	6.683	44.67
.2951	.08710	10.6	3.388	11.48	.1479	.02188	16.6	6.761	45.71
.2917	.08511	10.7	3.428	11.75	.1462	.02138	16.7	6.839	46.77
.2884	.08318	10.8	3.467	12.02	.1445	.02089	16.8	6.918	47.86
.2851	.08128	10.9	3.508	12.30	.1429	.02042	16.9	6.998	48.98
.2818	.07943	11.0	3.548	12.59	.1413	.01995	17.0	7.079	50.12
.2786	.07762	11.1	3.589	12.88	.1396	.01950	17.1	7.161	51.29
.2754	.07586	11.2	3.631	13.18	.1380	.01905	17.2	7.244	52.48
.2723	.07413	11.3	3.673	13.49	.1365	.01862	17.3	7.328	53.70
.2692	.07244	11.4	3.715	13.80	.1349	.01820	17.4	7.413	54.95
.2661	.07079	11.5	3.758	14.13	.1334	.01778	17.5	7.499	56.23
.2630	.06918	11.6	3.802	14.45	.1318	.01738	17.6	7.586	57.54
.2600	.06761	11.7	3.846	14.79	.1303	.01698	17.7	7.674	58.88
.2570	.06607	11.8	3.890	15.14	.1288	.01660	17.8	7.762	60.26
.2541	.06457	11.9	3.936	15.49	.1274	.01622	17.9	7.852	61.66
.2512	.06310	12.0	3.981	15.85	.1259	.01585	18.0	7.943	63.10
.2483	.06166	12.1	4.027	16.22	.1245	.01549	18.1	8.035	64.57
.2455	.06026	12.2	4.074	16.60	.1230	.01514	18.2	8.128	66.07
.2427	.05888	12.3	4.121	16.98	.1216	.01479	18.3	8.222	67.61
.2399	.05754	12.4	4.169	17.38	.1202	.01445	18.4	8.318	69.18
.2371	.05623	12.5	4.217	17.78	.1189	.01413	18.5	8.414	70.79
.2344	.05495	12.6	4.266	18.20	.1175	.01380	18.6	8.511	72.44
.2317	.05370	12.7	4.315	18.62	.1161	.01349	18.7	8.610	74.13
.2291	.05248	12.8	4.365	19.05	.1148	.01318	18.8	8.710	75.86
.2265	.05129	12.9	4.416	19.50	.1135	.01288	18.9	8.811	77.62
.2239	.05012	13.0	4.467	19.95	.1122	.01259	19.0	8.913	79.43
.2213	.04898	13.1	4.519	20.42	.1109	.01230	19.1	9.016	81.28
.2188	.04786	13.2	4.571	20.89	.1096	.01202	19.2	9.120	83.18
.2163	.04677	13.3	4.624	21.38	.1084	.01175	19.3	9.226	85.11
.2138	.04571	13.4	4.677	21.88	.1072	.01148	19.4	9.333	87.10
.2113	.04467	13.5	4.732	22.39	.1059	.01122	19.5	9.441	89.13
.2089	.04365	13.6	4.786	22.91	.1047	.01096	19.6	9.550	91.20
.2065	.04266	13.7	4.842	23.44	.1035	.01072	19.7	9.661	93.33
.2042	.04169	13.8	4.898	23.99	.1023	.01047	19.8	9.772	95.50
.2018	.04074	13.9	4.955	24.55	.1012	.01023	19.9	9.886	97.72
.1995	.03981	14.0	5.012	25.12	.1000	.01000	20.0	10.000	100.00
.1972	.03890	14.1	5.070	25.70					
.1950	.03802	14.2	5.129	26.30					
.1928	.03715	14.3	5.188	26.92					
.1905	.03631	14.4	5.248	27.54					
.1884	.03548	14.5	5.309	28.18					
.1862	.03467	14.6	5.370	28.84					
.1841	.03388	14.7	5.433	29.51					
.1820	.03311	14.8	5.495	30.20					
.1799	.03236	14.9	5.559	30.90					
.1778	.03162	15.0	5.623	31.62					
.1758	.03090	15.1	5.689	32.36					
.1738	.03020	15.2	5.754	33.11					
.1718	.02951	15.3	5.821	33.88					
.1698	.02884	15.4	5.888	34.67					
.1679	.02818	15.5	5.957	35.48					
.1660	.02754	15.6	6.026	36.31					
.1641	.02692	15.7	6.095	37.15					
.1622	.02630	15.8	6.166	38.02					
.1603	.02570	15.9	6.237	38.90					

← dB →				
Voltage Ratio	Power Ratio	dB	Voltage Ratio	Power Ratio
3.162×10^{-1}	10^{-1}	10	3.162	10
10^{-1}	10^{-2}	20	10	10^2
3.162×10^{-2}	10^{-3}	30	3.162×10	10^3
10^{-2}	10^{-4}	40	10^2	10^4
3.162×10^{-3}	10^{-5}	50	3.162×10^2	10^5
10^{-3}	10^{-6}	60	10^3	10^6
3.162×10^{-4}	10^{-7}	70	3.162×10^3	10^7
10^{-4}	10^{-8}	80	10^4	10^8
3.162×10^{-5}	10^{-9}	90	3.162×10^4	10^9
10^{-5}	10^{-10}	100	10^5	10^{10}

To find decibel values outside the range of this table, see introduction to these tables.

Table II

GIVEN: $\left\{ \begin{array}{l} \text{Voltage} \\ \text{Current} \end{array} \right\}$ Ratio

TO FIND: Decibels

POWER RATIOS

To find the number of decibels corresponding to a given power ratio— Assume the given power ratio to be a voltage ratio and find the corresponding number of decibels from the table. The desired result is exactly one-half of the number of decibels thus found.

Example— Given: a power ratio of 3.41.

Find: 3.41 in the table:

3.41 → 10.655 dB (voltage)

10.655 dB × ½ = 5.328 dB (power)

Voltage Ratio	.00	.01	.02	.03	.04	.05	.06	.07	.08	.09
1.0	.000	.086	.172	.257	.341	.424	.506	.588	.668	.749
1.1	.828	.906	.984	1.062	1.138	1.214	1.289	1.364	1.438	1.511
1.2	1.584	1.656	1.727	1.798	1.868	1.938	2.007	2.076	2.144	2.212
1.3	2.279	2.345	2.411	2.477	2.542	2.607	2.671	2.734	2.798	2.860
1.4	2.923	2.984	3.046	3.107	3.167	3.227	3.287	3.346	3.405	3.464
1.5	3.522	3.580	3.637	3.694	3.750	3.807	3.862	3.918	3.973	4.028
1.6	4.082	4.137	4.190	4.244	4.297	4.350	4.402	4.454	4.506	4.558
1.7	4.609	4.660	4.711	4.761	4.811	4.861	4.910	4.959	5.008	5.057
1.8	5.105	5.154	5.201	5.249	5.296	5.343	5.390	5.437	5.483	5.529
1.9	5.575	5.621	5.666	5.711	5.756	5.801	5.845	5.889	5.933	5.977
2.0	6.021	6.064	6.107	6.150	6.193	6.235	6.277	6.319	6.361	6.403
2.1	6.444	6.486	6.527	6.568	6.608	6.649	6.689	6.729	6.769	6.809
2.2	6.848	6.888	6.927	6.966	7.005	7.044	7.082	7.121	7.159	7.197
2.3	7.235	7.272	7.310	7.347	7.384	7.421	7.458	7.495	7.532	7.568
2.4	7.604	7.640	7.676	7.712	7.748	7.783	7.819	7.854	7.889	7.924
2.5	7.959	7.993	8.028	8.062	8.097	8.131	8.165	8.199	8.232	8.266
2.6	8.299	8.333	8.366	8.399	8.432	8.465	8.498	8.530	8.563	8.595
2.7	8.627	8.659	8.691	8.723	8.755	8.787	8.818	8.850	8.881	8.912
2.8	8.943	8.974	9.005	9.036	9.066	9.097	9.127	9.158	9.188	9.218
2.9	9.248	9.278	9.308	9.337	9.367	9.396	9.426	9.455	9.484	9.513
3.0	9.542	9.571	9.600	9.629	9.657	9.686	9.714	9.743	9.771	9.799
3.1	9.827	9.855	9.883	9.911	9.939	9.966	9.994	10.021	10.049	10.076
3.2	10.103	10.130	10.157	10.184	10.211	10.238	10.264	10.291	10.317	10.344
3.3	10.370	10.397	10.423	10.449	10.475	10.501	10.527	10.553	10.578	10.604
3.4	10.630	10.655	10.681	10.706	10.731	10.756	10.782	10.807	10.832	10.857
3.5	10.881	10.906	10.931	10.955	10.980	11.005	11.029	11.053	11.078	11.102
3.6	11.126	11.150	11.174	11.198	11.222	11.246	11.270	11.293	11.317	11.341
3.7	11.364	11.387	11.411	11.434	11.457	11.481	11.504	11.527	11.550	11.573
3.8	11.596	11.618	11.641	11.664	11.687	11.709	11.732	11.754	11.777	11.799
3.9	11.821	11.844	11.866	11.888	11.910	11.932	11.954	11.976	11.998	12.019
4.0	12.041	12.063	12.085	12.106	12.128	12.149	12.171	12.192	12.213	12.234
4.1	12.256	12.277	12.298	12.319	12.340	12.361	12.382	12.403	12.424	12.444
4.2	12.465	12.486	12.506	12.527	12.547	12.568	12.588	12.609	12.629	12.649
4.3	12.669	12.690	12.710	12.730	12.750	12.770	12.790	12.810	12.829	12.849
4.4	12.869	12.889	12.908	12.928	12.948	12.967	12.987	13.006	13.026	13.045
4.5	13.064	13.084	13.103	13.122	13.141	13.160	13.179	13.198	13.217	13.236
4.6	13.255	13.274	13.293	13.312	13.330	13.349	13.368	13.386	13.405	13.423
4.7	13.442	13.460	13.479	13.497	13.516	13.534	13.552	13.570	13.589	13.607
4.8	13.625	13.643	13.661	13.679	13.697	13.715	13.733	13.751	13.768	13.786
4.9	13.804	13.822	13.839	13.857	13.875	13.892	13.910	13.927	13.945	13.962
5.0	13.979	13.997	14.014	14.031	14.049	14.066	14.083	14.100	14.117	14.134
5.1	14.151	14.168	14.185	14.202	14.219	14.236	14.253	14.270	14.287	14.303
5.2	14.320	14.337	14.353	14.370	14.387	14.403	14.420	14.436	14.453	14.469
5.3	14.486	14.502	14.518	14.535	14.551	14.567	14.583	14.599	14.616	14.632
5.4	14.648	14.664	14.680	14.696	14.712	14.728	14.744	14.760	14.776	14.791
5.5	14.807	14.823	14.839	14.855	14.870	14.886	14.902	14.917	14.933	14.948
5.6	14.964	14.979	14.995	15.010	15.026	15.041	15.056	15.072	15.087	15.102
5.7	15.117	15.133	15.148	15.163	15.178	15.193	15.208	15.224	15.239	15.254
5.8	15.269	15.284	15.298	15.313	15.328	15.343	15.358	15.373	15.388	15.402
5.9	15.417	15.432	15.446	15.461	15.476	15.490	15.505	15.519	15.534	15.549

Table II (continued)

Voltage Ratio	.00	.01	.02	.03	.04	.05	.06	.07	.08	.09
6.0	15.563	15.577	15.592	15.606	15.621	15.635	15.649	15.664	15.678	15.692
6.1	15.707	15.721	15.735	15.749	15.763	15.778	15.792	15.806	15.820	15.834
6.2	15.848	15.862	15.876	15.890	15.904	15.918	15.931	15.945	15.959	15.973
6.3	15.987	16.001	16.014	16.028	16.042	16.055	16.069	16.083	16.096	16.110
6.4	16.124	16.137	16.151	16.164	16.178	16.191	16.205	16.218	16.232	16.245
6.5	16.258	16.272	16.285	16.298	16.312	16.325	16.338	16.351	16.365	16.378
6.6	16.391	16.404	16.417	16.430	16.443	16.456	16.469	16.483	16.496	16.509
6.7	16.521	16.534	16.547	16.560	16.573	16.586	16.599	16.612	16.625	16.637
6.8	16.650	16.663	16.676	16.688	16.701	16.714	16.726	16.739	16.752	16.764
6.9	16.777	16.790	16.802	16.815	16.827	16.840	16.852	16.865	16.877	16.890
7.0	16.902	16.914	16.927	16.939	16.951	16.964	16.976	16.988	17.001	17.013
7.1	17.025	17.037	17.050	17.062	17.074	17.086	17.098	17.110	17.122	17.135
7.2	17.147	17.159	17.171	17.183	17.195	17.207	17.219	17.231	17.243	17.255
7.3	17.266	17.278	17.290	17.302	17.314	17.326	17.338	17.349	17.361	17.373
7.4	17.385	17.396	17.408	17.420	17.431	17.443	17.455	17.466	17.478	17.490
7.5	17.501	17.513	17.524	17.536	17.547	17.559	17.570	17.582	17.593	17.605
7.6	17.616	17.628	17.639	17.650	17.662	17.673	17.685	17.696	17.707	17.719
7.7	17.730	17.741	17.752	17.764	17.775	17.786	17.797	17.808	17.820	17.831
7.8	17.842	17.853	17.864	17.875	17.886	17.897	17.908	17.919	17.931	17.942
7.9	17.953	17.964	17.975	17.985	17.996	18.007	18.018	18.029	18.040	18.051
8.0	18.062	18.073	18.083	18.094	18.105	18.116	18.127	18.137	18.148	18.159
8.1	18.170	18.180	18.191	18.202	18.212	18.223	18.234	18.244	18.255	18.266
8.2	18.276	18.287	18.297	18.308	18.319	18.329	18.340	18.350	18.361	18.371
8.3	18.382	18.392	18.402	18.413	18.423	18.434	18.444	18.455	18.465	18.475
8.4	18.486	18.496	18.506	18.517	18.527	18.537	18.547	18.558	18.568	18.578
8.5	18.588	18.599	18.609	18.619	18.629	18.639	18.649	18.660	18.670	18.680
8.6	18.690	18.700	18.710	18.720	18.730	18.740	18.750	18.760	18.770	18.780
8.7	18.790	18.800	18.810	18.820	18.830	18.840	18.850	18.860	18.870	18.880
8.8	18.890	18.900	18.909	18.919	18.929	18.939	18.949	18.958	18.968	18.978
8.9	18.988	18.998	19.007	19.017	19.027	19.036	19.046	19.056	19.066	19.075
9.0	19.085	19.094	19.104	19.114	19.123	19.133	19.143	19.152	19.162	19.171
9.1	19.181	19.190	19.200	19.209	19.219	19.228	19.238	19.247	19.257	19.266
9.2	19.276	19.285	19.295	19.304	19.313	19.323	19.332	19.342	19.351	19.360
9.3	19.370	19.379	19.388	19.398	19.407	19.416	19.426	19.435	19.444	19.453
9.4	19.463	19.472	19.481	19.490	19.499	19.509	19.518	19.527	19.536	19.545
9.5	19.554	19.564	19.573	19.582	19.591	19.600	19.609	19.618	19.627	19.636
9.6	19.645	19.654	19.664	19.673	19.682	19.691	19.700	19.709	19.718	19.726
9.7	19.735	19.744	19.753	19.762	19.771	19.780	19.789	19.798	19.807	19.816
9.8	19.825	19.833	19.842	19.851	19.860	19.869	19.878	19.886	19.895	19.904
9.9	19.913	19.921	19.930	19.939	19.948	19.956	19.965	19.974	19.983	19.991

Voltage Ratio	0	1	2	3	4	5	6	7	8	9
10	20.000	20.828	21.584	22.279	22.923	23.522	24.082	24.609	25.105	25.575
20	26.021	26.444	26.848	27.235	27.604	27.959	28.299	28.627	28.943	29.248
30	29.542	29.827	30.103	30.370	30.630	30.881	31.126	31.364	31.596	31.821
40	32.041	32.256	32.465	32.669	32.869	33.064	33.255	33.442	33.625	33.804
50	33.979	34.151	34.320	34.486	34.648	34.807	34.964	35.117	35.269	35.417
60	35.563	35.707	35.848	35.987	36.124	36.258	36.391	36.521	36.650	36.777
70	36.902	37.025	37.147	37.266	37.385	37.501	37.616	37.730	37.842	37.953
80	38.062	38.170	38.276	38.382	38.486	38.588	38.690	38.790	38.890	38.988
90	39.085	39.181	39.276	39.370	39.463	39.554	39.645	39.735	39.825	39.913
100	40.000	—	—	—	—	—	—	—	—	—

To find decibel values outside the range of this table, see introduction to these tables.

Federal Stock Numbers of General Radio Products

Catalog Number	Federal Stock Number	Agency	Catalog Number	Federal Stock Number	Agency	Catalog Number	Federal Stock Number	Agency
0274-9730	5935-543-8325	AF	0874-9700	5985-671-8325	DESC	0938-9791	5940-258-4719	
0274-9731	5935-543-8323	AF	0874-9701	5935-961-5498		0938-9791	5940-642-4355	
0274-9735	5935-505-4976		0874-9702	5985-707-2830	DESC	0938-9792	5970-237-5691	DSA
0274-9736	5935-192-4620	AF	0874-9704	6625-706-6269	AF	0938-9793	5935-258-4738	
0274-9736	5935-258-6298		0874-9706	5935-053-0040		0938-9796	5940-522-3622	
0274-9737	5935-224-5982	DESC	0874-9710	5935-087-5374		0940-9705	6625-842-4869	AF
0274-9746	5935-549-2118	DESC	0874-9710	5935-833-7247	N	0940-9706	6625-842-4871	AF
0274-9746	5935-665-4394	DESC	0874-9711	5935-905-5335		0940-9707	6625-842-4858	AF
0274-9747	5935-754-5770	AF	0874-9716	5935-758-9529		0940-9708	6625-842-4872	AF
0274-9748	5995-557-0848		0874-9717	5935-904-8557	DESC	0971-9702	5905-681-5653	
0274-9748	5995-642-9560		0874-9718	5935-502-8354		0971-9706	5905-583-2759	
0274-9750	6625-557-8454	DSA	0874-9791	5935-420-3645		0971-9708	5905-762-2547	
0274-9751	5935-872-8525	DESC	0874-9800	5935-984-5563	DESC	0971-9710	5905-557-1569	
0480-9986	5975-953-8144	ARMY	0874-9802	5935-706-2827		0971-9711	5905-583-2759	
0510-9511	5930-499-1999	DESC	0874-9804	5935-921-8789		0971-9712	5905-927-7538	
0510-9604	5930-499-2000	DESC	0874-9810	5935-225-8768	DESC	0971-9713	5905-887-7672	
0510-9701	6625-553-8082	AF	0874-9810	5935-679-2492	AF	0971-9714	5905-581-1724	
0510-9702	6625-311-6104	AF	0874-9816	5935-761-0408	DESC	0971-9716	5905-881-8062	
0510-9703	6625-993-1190	AF, N	0874-9818	5935-666-4873		0973-9704	5905-052-1927	
0510-9704	6625-864-6074	AF, N	0874-9820	5935-887-6008		0973-9705	5905-089-5434	
0510-9704	5910-960-6248	DESC	0874-9831	5935-916-0791		0973-9707	5905-660-3747	AF
0510-9705	5905-561-4150	DESC	0874-9832	5935-789-6031	DESC	0973-9708	5905-827-1899	
0510-9705	6625-709-0308	AF	0874-9833	5935-981-7264	AF	0973-9710	5905-690-5684	AF, DESC
0510-9705	6625-989-8428	N	0874-9834	5935-914-8878		0973-9712	5905-658-1325	
0510-9706	5905-561-4158	DESC	0874-9839	5935-840-7284	DESC	0973-9714	5905-583-5254	
0510-9706	6625-709-0310	AF	0874-9841	5935-965-6178	AF	0973-9716	5905-406-9897	DESC
0510-9707	6625-708-7235	AF, N	0874-9843	5935-944-3687	DESC	0973-9717	5905-074-8719	
0510-9708	5905-561-4160	DESC	0874-9849	5935-925-6261		0975-9710	5905-681-3390	
0510-9806	6625-690-5156	AF	0874-9853	5935-925-6262	DESC	0975-9712	5905-683-2340	NASA
0631-9601	5960-193-5124		0874-9863	6145-020-8773		0975-9713	5905-556-6565	
0716-9803	6625-649-2961	AF	0874-9864	5935-555-1885	DESC	0975-9716	5905-725-0725	AF
0874-9511	5985-912-1544		0874-9864	5975-104-6840	DESC	0975-9717	5905-806-3715	AF, DESC
0874-9513	6625-623-0067		0874-9910	5935-864-9958		0975-9718	5905-617-2109	AF
0874-9526	5935-627-0622	AF	0874-9940	6625-793-1352	AF	1001-9701	6625-866-0168	AF
0874-9527	5935-933-8153		0874-9942	5985-778-2146		1003-9701	6625-867-0787	
0874-9537	5915-786-9168	DESC	0874-9944	6625-624-7149	AF	1162-9597	6625-333-9860	AF
0874-9541	5915-937-5404		0874-9945	6625-623-0328	N	1191-9711	6625-926-7641	ARMY
0874-9545	5915-907-8721		0874-9954	5985-992-2109	DESC	1201-9703	4920-925-7490	N
0874-9564	5985-525-3010	DESC	0874-9955	5985-494-4745	DESC	1201-9703	6625-902-9745	
0874-9568	5905-812-9250		0874-9970	5985-083-4708		1203-9702	6625-777-6438	NASA
0874-9570	5905-755-2378	DESC	0874-9972	6625-706-2829		1203-9702	1440-062-4760	N
0874-9570	6625-826-0570		0874-9980	5985-888-4296	DESC	1210-9703	4920-925-7490	N
0874-9571	5985-087-4715	DESC	0874-9982	5985-707-2931		1211-9703	4931-777-1384	AF
0874-9572	5985-080-2122	DESC	0874-9990	5935-669-5817		1215-9703	6625-965-8235	
0874-9572	6625-739-1200	AF	0874-9903	6625-932-8155	AF	1217-9703	6625-903-5469	AF
0874-9577	5950-752-3144	DESC	0900-9405	5935-000-0202		1232-9701	6625-873-6684	AF
0874-9577	5950-921-6008	AF	0900-9651	6625-498-0925		1232-9701	4931-916-8256	DSA
0874-9577	6625-921-6305	N	0900-9711	5935-838-2722	AF	1263-9703	6625-061-0214	AF
0874-9577	5985-823-4709	ASO, DESC	0900-9791	5935-466-1172	DESC	1264-9601	5595-087-4832	DSA
0874-9596	6625-887-7753	AF	0900-9811	5935-838-2723	AF	1269-9701	6625-871-8018	AF
0874-9604	6625-713-2108	AF	0900-9883	4931-228-1319	DSA	1304-9802	6625-565-9736	AF
0874-9608	6625-713-2109	AF	0900-9971	5985-083-4708		1304-9812	4931-778-0582	
0874-9612	6625-715-5578	AF	0938-9758	5935-295-5407		1309-9701	6625-107-8260	AF
0874-9621	5985-911-0540	DESC	0938-9760	5940-562-3507		1310-9701	6625-054-3476	DESC
0874-9645	4920-922-6219	N	0938-9764	5940-235-7993		1311-9701	6625-930-3449	DSA
0874-9660	6625-059-7768		0938-9765	5935-815-8793	DSA	1330-9701	6625-553-0969	AF
0874-9666	6625-020-9712	AF	0938-9765	5940-877-8166		1362-9701	6625-489-3711	AF
0874-9680	6625-789-4723		0938-9766	5940-223-1434		1390-9702	6625-799-8999	AF
0874-9680	5995-836-5152	AF	0938-9766	5940-250-0577	M.C.	1401-9702	6625-585-3992	AF
0874-9682	5995-754-8178	N	0938-9766	5940-544-8121		1401-9703	6625-585-3989	AF
0874-9683	5995-933-6852	DSA	0938-9767	5940-500-8717		1403-9701	6625-730-8565	AF
0874-9683	5995-935-2561	DSA	0938-9767	5940-666-3892		1403-9704	6625-804-7402	AF
0874-9690	6625-793-1351	AF	0938-9768	5940-549-9037		1403-9707	6625-804-7401	AF
0874-9692	6625-729-4629	AF	0938-9768	5940-643-6231		1403-9711	6625-804-9059	AF
0874-9700	5935-765-5481	DESC	0938-9771	5940-549-6743		1403-9714	6625-804-9053	AF
0874-9700	5935-855-3770	DESC	0938-9776	5970-628-7701		1404-9701	4931-916-5949	AF

Catalog Number	Federal Stock Number	Agency	Catalog Number	Federal Stock Number	Agency	Catalog Number	Federal Stock Number	Agency
1409-9706	6625-629-1983	AF	1557-9701	6625-879-5114		*	5950-224-7874	AF
1409-9707	6625-804-9058		1560-9605	5965-971-5635		3040-5111	5950-835-4462	AF, DESC
1409-9711	6625-585-4052	AF	1560-9652	6625-982-9461	A	3040-5118	5950-681-7431	AF, DESC
1409-9712	6625-585-4053	AF	1560-9695	6625-459-7539	AF	3050-5110	6120-845-1176	AF
1409-9713	6625-583-0038	AF	1560-9696	6625-982-9460	A	3050-5111	6120-242-4865	DSA
1409-9718	6625-557-0876	AF	1560-9921	6625-086-9982		3050-5130	5820-756-5566	
1409-9720	6625-585-4051	AF	1562-9701	6625-401-5364	AF	3058-5110	6120-105-6108	AF, DESC
1409-9721	6625-585-4050	AF	1564-9701	6625-883-8858	N	3060-5012	6120-054-7794	AF
1409-9724	6625-653-1565	AF	1564-9771	6625-484-5970	N	3060-5110	6120-849-2588	AF
1409-9725	6625-629-1980	AF	1565-9701	6625-912-6149	AF	3060-5110	5950-948-6988	DESC
1419-9701	6625-953-7537	AF	1565-9901	6515-236-1204	AF	3060-5111	6120-816-1517	DESC
1419-9702	6625-679-0402		1568-9701	6625-454-0720	AF	3060-5118	6120-772-7917	AF
1419-9711	6625-585-1670	AF	1571-9831	6110-087-4771	DSA	3060-5119	6120-682-2557	DESC
1422-9704	6625-987-9060	AF	1571-9898	6110-897-9800	AF	3060-5119	5950-682-2557	AF
1422-9909	6625-846-4429		1602-9702	6625-511-0512	AF	3060-5130	6120-805-0745	DESC
1422-9823	6625-779-3602	A	1606-9702	6625-432-5414	N	3070-5110	6120-660-9211	AF
1422-9855	6625-060-1818		1606-9702	combined with	AF	3070-5111	6120-828-1490	AF
1422-9916	6625-891-5939	AF	1606-9602	6625-103-2040		3070-5118	5950-686-2153	
1423-9801	6625-775-1753	AF	1608-9811	6625-902-8687	AF	3070-5119	6625-073-2226	N
1424-9701	6625-731-7404	AF	1609-9701	6625-106-0643	AF	3090-5110	6120-800-2482	AF
1433-9700	6625-892-4783	N	1620-9701	4931-916-5952		3090-5111	6120-834-2923	AF
1433-9702	6625-437-9157	AF	1632-9801	6625-223-4811	AF	3090-5119	6120-833-0904	DSA
1433-9702	6625-649-4037	N	1632-9801	6625-476-0593	AF	3090-5130	6120-669-8565	AF
1433-9712	6625-649-0034	N	1632-9811	6625-777-4118		3090-5230	5950-068-5180	AF, DESC
1433-9716	6625-228-9918	N	1633-9801	6625-442-3549	ARMY	3100-5012	5950-926-0742	DESC
1433-9718	6625-123-7459	N	1644-9701	6625-867-6628	N	3100-5110	6120-710-5747	AF
1433-9722	6625-947-7534	AF	1650-9702	6625-435-5470	AF	3100-5110	6120-103-4982	N
1433-9731	6625-480-0950	N	1790-9705	6625-243-7461	AF	3100-5111	6120-877-7923	AF, DESC
1440-9601	6625-133-7548	A	1806-9701	6625-832-8956		3120-5110	5950-078-1445	
1450-9891	6625-201-8779	N, DESC	1840-9701	6625-937-6156	AF	3130-5111	6120-849-8928	AF
1450-9891	5985-201-8779	N, DESC		6625-777-7436	FAA	3150-5110	6120-681-6862	AF
1450-9893	6625-612-1837	AF	1863-9700	6625-456-7442	AF	3150-5111	6120-769-1140	DESC
1455-9700	6625-123-7458	AF	1863-9700	6625-553-0386	N	3150-5120	6120-911-9777	
1455-9702	6625-722-1569	AF	2990-9201	4931-178-1108	ARMY	3160-5121	6120-927-7826	
1482-9702	6625-583-0040	AF	2990-9159	6625-411-4538	AF	3160-5130	6120-811-0505	DESC
1482-9703	6625-804-4125	AF	3010-5110	5950-606-8682	DESC	3200-5900	5977-400-7985	DSA
1482-9704	6625-806-8627		3010-5110	5950-581-5189	AF	3200-5901	5977-536-3287	
1482-9705	6625-567-2700	AF	3010-5110	5950-519-7859	DESC	3200-5906	5977-775-6799	
1482-9706	6625-580-1501	AF	*	5950-807-0947	DESC	3200-5908	5977-727-9061	
1482-9707	6625-580-1502	AF	3010-5111	5950-683-3641	DESC	3200-5910	5977-880-1553	
1482-9708	6625-583-0041	AF	3010-5120	5950-082-8153		3200-5911	5977-033-8550	
1482-9710	6625-993-9456	AF	3010-5130	6120-837-7133	AF	3200-5912	5977-877-6844	
1482-9711	6625-556-8585	AF	*	5950-556-1724	AF	3200-5913	5977-841-5878	
1482-9712	6625-556-8584	AF	*	5950-985-3990	DESC	3200-5923	5977-433-2716	DSA
1482-9713	6625-804-4129	AF	3030-5012	5950-987-5601	DESC	3410-5110	5950-121-5326	DESC
1482-9714	6625-804-4130		3030-5013	4931-777-1385		3410-5110	5950-519-7789	DESC
1482-9716	6625-583-0044	AF	3030-5015	5950-112-3440	DESC	3410-5110	5950-538-5662	AF
1482-9717	6625-993-9458		3030-5110	5950-053-9971	DESC	3410-5110	5950-617-9474	ARMY
1482-9718	6625-993-9459	AF	3030-5110	5950-631-1424	DESC	3410-5120	5950-557-6989	AF
1482-9720	6625-583-0043	AF	3030-5110	5950-951-9647	DESC	3410-5130	5950-557-6988	DESC
1491-9714	6625-808-9523	AF, N	3030-5110	5950-754-5940	AF, DESC	3410-5130	5950-877-4863	DESC
1521-9428	6625-864-0631	N	3030-5110	5950-578-5592	AF	3430-5110	5950-504-9090	AF, DESC
1521-9447	6625-450-7622	AF	*	5950-443-1794	DESC	3430-5110	5950-615-0209	DESC
1521-9463	6625-862-0632		3030-5111	5950-553-6657	AF	3430-5120	5950-103-7005	DESC
1521-9601	5905-448-5331		*	5950-020-6790	AF, DESC	3430-5130	5950-99-1261	DESC
1521-9602	5905-448-5335		3030-5118	5950-688-5722	AF, DESC	3460-5110	6120-480-5581	N
1521-9603	5905-448-5334		3030-5118	5950-446-5004	AF, DESC	3460-5110	5950-689-4807	DESC
1521-9841	6625-484-5972	N	3030-5118	5950-823-1051	DESC	3460-5110	6120-812-7681	AF
1525-9701	6625-411-9633	AF	3030-5119	5950-617-9242	DESC	3460-5110	6120-826-6238	AF
1531-9430	6680-880-1844	N	3030-5120	6120-884-1441	AF	3460-5120	5950-755-9349	
1531-9601	5960-844-5968	DESC	3030-5130	6120-681-6930	AF	3460-5130	5950-504-9047	AF
1538-9601	5960-781-1466	DESC	*	5950-683-3206		3460-5130	6120-504-9047	DSA
1538-9601	6240-422-1278	ARMY	3030-5131	6120-879-3698	AF	3490-5110	6120-824-7393	AF
1551-9703	6625-969-4136	DSA	3038-5110	5950-110-0379	DESC	3490-5110	6120-052-3305	DSA
1551-9703	combined with		3038-5130	6120-357-7520	DSA	3490-5130	6120-725-4226	AF
1262-9702	4931-891-3070	ARMY	3040-5110	5950-809-5379	DESC			
1553-9701	6625-103-3117	AF						
1553-9701	6625-977-5779	N						
1556-9702	6625-994-9424	AF						

* Like preceding entry with additional moisture and fungus proofing.

Index by Subject and Title

A

Abbreviations	344
Accelerometer	100
Acoustic Recorder	47, 49, 52
Acoustic Systems	22
Adaptor, 50- Ω coax, GR874	240
50- Ω coax, GR900	261
75- Ω coax, GR874	252
75 to 50 Ω , GR900	266
75- Ω coax, GR900	266
Audio/Acoustic	98
Flange, GR900	260
Low-Frequency	355
Microphone	98
Rack Panel	338
Adjustable Autotransformers	293
Admittance Meter, UHF	210
Air Capacitor, Standard	178
Air Line, Fixed, 50- Ω coax, GR874	247
50- Ω coax, GR900	265
75- Ω coax, GR874	254
Adjustable, 50- Ω coax, GR874	247
Tube and Rod, 50-, 75- Ω , GR874	256
Tube and Rod, 50- Ω , GR900	268
Amplifier, 30-MHz I-F	215
Level Regulating	89
Multichannel, Audio	88
Power, Audio	76
Programmable	88
Scanning, Multichannel	88
Tuned	162
Analog Limit Comparator	149
Analog Tester, Multistation	108
Analyzer, 1/3 and 1/10 Octave	57
Fast-Fourier	70
Impact-Noise	27
Impulse-Noise, Precision	45
Logic-Circuit	110, 112, 115
Motion, Stroboscopic	269
Narrow Band	58, 60
Octave-Band	45
Real-Time	64, 70
RF Network	202
Signal	56
Sound and Vibration	57
Sound and Vibration, Recording	62
Sound-Level, Precision	45
Spectrum	58, 60
Third-Octave-Band, Stepped	52
Time-Series	70

Analyzer (cont'd)

Wave	58, 60
Wave, Recording	62, 63
Anodize Trimmer	
Systems	122, 123, 124
Attenuation Analyzer, RF	202
Attenuator, 50- Ω coax, GR874	245
50- Ω coax, GR900	264
75- Ω coax, GR874	254
Audio	92
Decade	322
Level Regulating	89
Low-Frequency	92, 246, 322, 323
Programmable Decade	246
Audio Amplifier, Multichannel	88
Audiometer Calibration Set	37
Audiometer, Recording	35
Audiometric Examination Rooms	34
Audiometry and Psychoacoustics	102
Audio Microvolter	92
Oscillator	77, 78, 79
Oscillator and Power Amplifier	76
Output Power Meter	90
Automatic Capacitance Bridge, 1-MHz	142
Component Test Systems	129, 136
Level Regulator	89
Line-Voltage Regulators	285
RLC bridge	138
Test and Measurement Systems	106
Autotransformers, Adjustable	293

B

Balun	243
Banana Plugs	334
Behavioral Research Instruments	103
Bias Insertion Unit, 50- Ω coax, GR874	250
Bias Supply	146
Binding Posts	332
Booth, Audiometric	34
Box, Capacitance	167-171
Inductance	198
Resistance	184-188
Bridge, 1-MHz Capacitance, Automatic	142
Bias Supply	146
Capacitance	161, 164
Capacitance, Precision	157
Conductance	181
Detector, Phase	159
Impedance, Manual	150, 152, 154

Bridge (cont'd)

Incremental-Inductance	195
Inductance	193, 195
Kelvin	181
Megohm	181, 182
Oscillator	158, 318
Oscillator/Detector	163
Portable	150, 154, 181
Precision	152, 156, 160, 181, 192
Resistance, DC	181
Resistance Limit	180
RF	211
RF, 50-, 75- Ω coax, GR874	256
RF Network Analyzer	202
RLC, Automatic	138
RLC, Manual	150, 152, 154
Wheatstone	181, 182
Brushes, Replacement, Variac	312
Burst Generator	321
Burst Generator, Strobe	281

C

Cabinets, Instrument	339
Cable, 50- Ω coax, GR874	251
Connectors, 50- Ω coax, GR874	239
Connectors, 50- Ω coax, GR900	260
Connectors, 75- Ω coax, GR874	252
Measurement Analyzer, RF	202
Microphone	98
Test System	132
Calibrator, AC/DC Voltage	92
Sound-Level	38
Audiometer	37
Vibration	101
Capacitance Bridge	161, 164
Bridge, Automatic	138
Bridge, Automatic, 1-MHz	142
Bridge, Manual	150, 152, 154
Bridge, Precision	157
Comparator	147
Measuring Assembly	160
Measuring System, Precision	156
Meter, Digital	140
Standards, Coaxial	176, 177, 178
Capacitor, Coupling, 50- Ω coax, GR874	250
Decade	167-171
Decade, Precision	167, 168
Leakage Test System	130
Standard, Air	178

Capacitor (Cont'd)			
Standard, Fixed	174, 175		
Standard, Mica	179		
Variable, coax, GR874	245		
Variable Precision	172		
Card-Punch Coupler	145		
Case, Storage, GR900	268		
Cassette Data Recorder	47		
Centering Ring, Rotatable, GR900	260		
Ceramic Microphones	94		
Chart Paper	51, 55, 87		
Chart Paper, Audiometer	35		
Choke, Paralleling, Variac	312		
Circuit/Component Tester, Multistation	108		
Circuit Tester, Digital	110, 112, 115		
Circuit Tester, Linear	125		
Cleaning Kit, GR900	268		
Coaxial Adaptor, 50- Ω , GR874	240		
Adaptor, 50- Ω , GR900	261		
Adaptor, 75- Ω , GR874	252		
Adaptor, 75- Ω , GR900	266		
Adaptor Flange, GR900	260		
Air Lines, 50- Ω , GR874	247		
Air Lines, 50- Ω , GR900	265		
Air Line, 75- Ω , GR874	254		
Air-Line Tube and Rod, 50-, 75- Ω , GR874	256		
Air-Line Rod and Tube, 50- Ω , GR900	268		
Attenuators, 50- Ω , GR874	245		
Attenuators, 50- Ω , GR900	264		
Attenuators, 75- Ω , GR874	254		
Bias Insertion Unit, 50- Ω , GR874	250		
Cable, 50- Ω , GR874	251		
Cable Connectors, 50- Ω , GR900	260		
Capacitance Standards	176, 177, 178		
Centering Ring, Rotatable, GR900	260		
Cleaning Kit, GR900	268		
Components, GR874	237		
Components, GR900	257		
Components, 75- Ω , GR874	252		
Components, 75- Ω , GR900	266		
Component Mount, 50- Ω , GR874	250		
Connector, 50- Ω , GR874	238		
Connector, 50- Ω , coax, GR900	259		
Connector, 75- Ω , GR874	252		
Connector, 75- Ω , GR900	266		
Connector Kits, 50- Ω , GR900	259		
Coaxial (cont'd)			
Coupling Capacitor, 50- Ω , GR874	250		
Coupling Probe, 50- Ω , GR874	250		
Crimping Tools, GR874	255		
EII, 50- Ω , GR874	248		
EII, 75- Ω , GR900	268		
Hardware Stand, GR874	255		
Insertion Unit, 50- Ω , GR874	250		
Lines, Slotted	212, 213		
Low-Pass Filters, 50- Ω , GR874	249		
Matching Pad, 75 to 50 Ω , GR874	253		
Matching Pad, 50 to 75 Ω , GR900	267		
Mixer, 50- Ω , GR874	248		
Panel Mounting Kit, GR900	260		
Patch Cords, 50-, 72-, 75- Ω , GR874	251		
Power Dividers, 50- Ω , GR874	248		
Rectifier/Detector, 50- Ω , GR874	249		
Resistance Standards	191		
RF Bridges, 50-, 75- Ω , GR874	256		
Rotary Joint, 50- Ω , GR874	248		
Series Inductor, 50- Ω , GR874	250		
Storage Case, GR900	268		
Tee, 50- Ω , GR874	248		
Termination, 50- Ω , GR874	244		
Termination, 50- Ω , GR900	263		
Termination, 75- Ω , GR874	254		
Termination, 75- Ω , GR900	267		
Tool Kit, GR900	268		
Tuner, 50- Ω , GR900	264		
Comparator, Analog Limit	149		
Digital Limit	144		
Impedance	147		
Resistance	180		
Component and Network Testing	105		
Component/Circuit Tester, Multistation	108		
Component Mount, 50- Ω coax, GR874	250		
Components, 50- Ω coax, GR874	237		
75- Ω coax, GR874	252		
50- Ω coax, GR900	257		
75- Ω coax, GR900	266		
Component Sorting Systems	129, 147		
Component Testing Systems	129, 136		
Computer-aided N/C Fabrication	118		
ComputerWrap™ Wire-Wrapping Systems	116		
Condenser Microphones	93		
Condenser Microphone Systems	99		
Connector Kits, 50- Ω coax, GR900	259		
Connectors, 50- Ω coax, GR874	238		
50- Ω coax, GR900	259		
75- Ω coax, GR874	252		
75- Ω coax, GR900	266		
Binding Post	332		
Jacks and Plugs	334		
Controllers, Line Voltage	269, 293		
Controls, Volume, Pots	337		
Counter, Frequency	326, 328		
Coupler, Card-Punch	145		
Coupler, Directional, Precision	217		
Coupler, Earphone	37		
Coupling Capacitor, 50- Ω coax, GR874	250		
Coupling Probe, 50- Ω coax, GR874	250		
Crimping Tools, GR874	255		
D			
Data Recorder, Audio	47		
DC Power Supply, Adjustable	196		
DC Recorder	86		
Decade Attenuator	322		
Attenuator, Programmable	246		
Capacitors	167-171		
Capacitor, Precision	167, 168		
Inductors	198, 199		
Oscillator	80		
Resistors	184-188		
Resistor, Programmable	184		
Voltage Divider	323		
Decibel Conversion Tables	345		
Delay Analyzer, RF	202		
Delay Generator, Strobe Flash	283		
Detector, 50- Ω coax, GR874	249		
Bridge	159		
Digital, RMS	69		
Heterodyne	214		
I-F Amplifier	215		
Null	162		
Oscillator, Bridge	163		
Phase	159		
RMS, Multichannel	69		
Dielectric Sample Holder	166		
Digital Detector, RMS, Multichannel	69		
Impedance Bridge	138		
Impedance Meter	140		
Limit Comparators	144		
Logic Testers	110, 112, 115		
Printer	145		
Tester, Multistation	108		

Digital (cont'd)	
Time-Series Analyzers	70
Vibration Control System	72
Dimension and Weight Definitions	341
Directional Coupler, Precision	217
Display Unit, Storage	66
Divider, Power, 50- Ω coax, GR874	248
Decade Voltage	323
Frequency	325
Dosimeter, Noise	30

E

Earphone Couplers	37
Electret-Condenser Microphones	93
Electrolytic Capacitance Bridge	164
Electronic Stroboscopes	269
EII, 50- Ω coax, GR874	248
75- Ω coax, GR900	268

F

Fast-Fourier Analyzers	70
Federal Stock Numbers	350
Filter, Analyzing	67
Low-Pass, 50- Ω coax, GR874	249
Octave-Band	67
Parallel-Band	67
Pink-Noise	85
Scanned	67
Third-Octave-Band	67
Universal Audio	91
Variable Bandwidth, Audio	91
Fixture, Test	151, 180
Fixtures, Transistor Test	255
Flange, Adaptor, GR900	260
Flash Delay, Strobe	283
Flash, Stroboscopic	269
Fourier Analyzers	70
Frequency and Time Meter (Counter)	326, 328
Frequency-Response Recorder	49, 52
Frequency-Response Recorder Assemblies	62
Frequency Scaler	325
Frequency Spectrum Analyzers	57, 58, 60
Frequency-Spectrum Analyzers, Real-Time	70
Frequency Synthesizers	222-227

G

Generator, Burst, Strobe	281
Pulse	319, 320
Random-Noise	81, 83, 84
Standard-Signal	232-236
Strobe Multiflash	281
Tone-Burst	321
Graphic Level Recorder	49, 52
Grason-Stadler Audiometer	35
Grason-Stadler Instruments	102

H

HardRATS-Anodize Trim System	123
Hearing Conservation	24
Hearing Research Instruments	102
Hearing Testing	33
Heterodyne Detectors	214
High-Frequency Measuring Systems	201
High-Frequency Oscillators	228
High-Frequency Signal Sources	219
High-Frequency Variac® autotransformers	303
Hi-Reliability Capacitor Testing System	129
Hybrid Trim System, Laser	120

I

I-F Amplifier	215
Impact-Noise Analyzer	27, 45
Impedance Analyzer, RF	202
Bridges	150, 152, 154
Bridge, Automatic	138
Bridge, RF	211
Comparator	147
Measuring System — Computer-Controlled	108, 125
Meter, Digital	140
Meter, UHF	210
Impulse Analyzer	27
Impulse Sound-Level Meter, Precision	45
Incremental-Inductance Bridge	195
Inductance Bridges	193, 195
Bridge, Automatic	138
Comparator	147
Measuring Assembly	192, 194
Meter, Digital	140
Inductor, Decade	198, 199
Inductor, Series, 50- Ω coax, GR874	250

Inductor, Standard	197
Industrial Hearing Conservation	24
Insertion Unit, 50- Ω coax, GR874	250
Insulation Testers, Megohm	181, 182, 183
Integrated-Circuit Tester, Linear	126

J

Jacks and Plugs	334
Joint, Rotary, 50- Ω coax, GR874	248

K

Kits, Coaxial Connector, 50- Ω , GR900	259
Kit, Coaxial Panel Mounting, GR900	260

L

Lamp, Replacement Strobe	278, 279
Laser Trim System	120
Leakage-Current Bridge	164
Measuring System	130
Tester, Megohm	181, 182, 183
Level Regulator, Audio	89
Lights, Stroboscopic	269
Limit Comparator, Analog	149
Digital	144
Line, Air, 50- Ω coax, GR900	265
50- Ω coax, GR874	274
75- Ω coax, GR874	254
Linear Circuit and IC Tester	126
Linear-Speed Wheel, Strobe	284
Line Stretchers, 50- Ω coax, GR874	274
Line-Voltage Control, Variac®	293
Line-Voltage Regulators	285
Logic-Circuit Test Systems	110, 112, 115
Low-Distortion Oscillator	77
Low-Frequency Oscillators	74
Low-Pass Filters, 50- Ω coax, GR874	249
Low-Voltage Variac® autotransformer	312

M

Magnetic Clamp	43
Main Voltage Controllers	269, 293
Matching Pad, 75 to 50- Ω coax GR874	253
GR900	267

Megohm Bridges	181, 182
Megohmmeters	183
Meter, Audio Output Power	90
Impact-Noise	27
Impedance, Digital	140
Impulse Sound-Level	45
Megohm	183
Sound-Level	26, 40
Sound Level, Precision	45
Standing-Wave	216
UHF Admittance	210
Vibration	42
Micronetic Laser Trim System	120
Microphone	93
Microphone Accessories	95
Extension Cable	98
Preamplifiers	95
Preamp Accessories	98
Systems, Condenser	99
Windscreens	97
Microvolter, Audio	92
Militarized Variac® autotransformers	303
MiniRATS-Anodize Trim System	122
Minivolt Adjustable Autotransformer	312
Mixer, 50- Ω coax, GR874	248
Monitor, Noise-Exposure	28
Monitor, Noise-Exposure, Wearable	30
Motion Analysis and Photography Set, Strobe	280
Motion Analyzers, Stroboscopic	269
Motor Controllers	294
Motor-Driven Variac® autotransformers	305
Mount, Component, 50- Ω coax, GR874	250
Mounting Information	339
Mount, Transistor	255
Multichannel Amplifier, Audio	88
Multichannel RMS Detector	69
Multifilter	67
Multiflash Generator, Strobe	281

N

Narrow-Band Analyzer	58, 60
Narrow-Band Analyzer, Automatic	62
Narrow-Band Analyzer, Real-Time	64
N/C Sheetmetal Fabrication	118
Network and Component Testing	105
Network Analyzer, RF	202
Noise Analyzer	57
Calibrators	38

Noise (cont'd)	
Dosimeter	30
Exposure Monitor	28
Exposure Monitor, Wearable	30
Generators, Random	81, 83, 84
Impact Analyzer	27
Impulse Analyzer	45
Measurement	21
Null Detector	162
I-F Amplifier	215
Phase	159

O

Occupational Safety and Health	24
Octave Analyzer	45
(1/3) Analyzer, Stepped	52
(1/3 and 1/10) Analyzer	57
Analyzer, Real-Time	64
Filter	67
Op-Amp Tester	126
Open Circuit, 50- Ω coax, GR874	244
75- Ω coax, GR874	254
Coaxial, GR900	263
Ordering Information	18
Oscillator, Audio	76, 77, 78, 79, 80
Audio to RF	78, 80, 318
Audio and Ultrasonic	77, 78, 80, 158
Bridge	158, 318
Bridge, Audio	79
Decade, Audio RF	80
Detector, Bridge	163
High-Frequency	228
Low-Distortion, Audio	77
Low-Frequency	74
Recorder, Sweep	52
Two-Phase	158
Oscilloscope, Storage	66
Output Power Meter, Audio	90

P

Pad, 50- Ω coax, GR874	245
50- Ω coax, GR900	264
75- Ω coax, GR874	254
Matching, 75-to-50- Ω coax, GR874	253
Matching, 75-to-50- Ω coax, GR900	267
Panel Connectors, 50- Ω coax, GR874	239
75- Ω coax, GR874	252
Passive Test System	108, 125

Patch Cords, Low-Frequency	98, 335
Patch Cords, 50-, 72-, 75- Ω coax, GR874	251
Pens, Audiometer Recording	35
Pens, Recorder	51, 55, 87
Phase Detector	159
Photoelectric Pickoffs	284
Photoflash, Stroboscopic	269
Photography and Motion Analysis Set, Strobe	280
Pickoffs, Photoelectric	284
Pink-Noise Filter	85
Plant-Noise Measurement	24
Plugs and Jack	334
Portable Variac® autotransformers	304
Potentiometers	337
Power Amplifier, Audio	76
Power Cords	336
Power Divider, 50- Ω coax, GR874	248
Power-Line Controller	269, 293
Power Meter, Audio Output	90
Power Supply, Adjustable DC	196
Bias	146
HF Oscillator	230
Preamplifier	97
Preamplifier	163
Accessories	98
Microphone	95
Power Supply	97
VHF/UHF	217
Printer, Digital	145
Probe, Coupling, 50- Ω coax, GR874	250
Product-Noise Reduction	39
Programmable, Amplifier, Multichannel	88
Bio-Medical Instruments	103
Bridges	138, 142
Comparators, Limit	144
Counters	326, 328
Decade Attenuator	246
Decade Resistor	184
Detector, RMS	69
Frequency Synthesizers	222-227
Network Analyzer	204
Recorders	52, 87
Signal Generator	232
Stroboscope	274
Voltage Regulator	289
Psychoacoustics and Audiometry	102
Publications	20
Publications, Strobe	273
Pulse Generators	319, 320

Q
Quiet Rooms34

R
Rack Adaptors 338
Radio-Frequency Bridge 211
Random-Noise Generators .. 81, 83, 84
RATS-Anodize Trim System 124
Reactance Charts 342
Real-Time Analyzers 64, 70
Receiver, 30-MHz, I-F Amplifier ... 215
Recorder, Cassette, Audio Data ... 47
 DC Strip-Chart 86
 Graphic Level 49, 52
 Portable 47
 Potentiometric 49, 52
 Programmable 86
 Sound-Level 47, 49, 52
 Strip Chart 49, 52
 Tape 47
 Third-Octave-Band 52
Recording Audiometer 35
 Sound and Vibration Analyzer .. 62
 Wave Analyzer 62, 63
Rectifier, 50- Ω coax, GR874 249
Reference Resistance Standard ... 189
Reference Standard Capacitors
 174, 175
Reflectometer, Sweep 208
Regulator, Audio-Level 89
 Line-Voltage 285
Resistance Anodize Trimmer
 Systems 122, 123, 124
 Bridge, Automatic 138
 Bridge, DC 181
 Bridge, Limit 180
 Bridge, Manual 150, 152, 154
 Bridge, Megohm 182
 Comparator 147
 Meter, Digital 140
 Standards, Coaxial 191
 Trim Systems 120
Resistive Termination, 50- Ω coax,
 GR874 244
 50- Ω coax, GR900 263
 75- Ω coax, GR874 254
 75- Ω coax, GR900 267
Resistor, Decade 184-188
 Programmable Decade 184
 Reference Standard 189
 Standard 190

Resistor (cont'd)
 Trim System, Anodize
 122, 123, 124
 Trim System, Laser 120
Response Analyzer, RF 202
RF Bridge, Impedance 211
RF Bridge, 50-, 75- Ω coax,
 GR874 256
RF Network Analyzer 202
RLC Bridge, Automatic 138
RLC Bridge, Manual ... 150, 152, 154
RMS Detector, Multichannel 69
Rod and Tube for 50-, 75- Ω Air
 Line, GR874 256
Rod and Tube for 50- Ω Air
 Line, GR900 268
Rooms, Audiometric Examination ... 34
Rotatable Centering Ring, GR900 ... 260

S

Sales Offices and Representatives .. 12
Sample Holder, Dielectric 166
Scaler, Frequency 325
Scanned Filter 67
Scanners, System 144
Scanning Amplifier, Multichannel .. 88
SCAT System 104
Screening Audiometer 35
Selection Guide-Automatic Test
 Systems 106
 Frequency Synthesizers 315
 High-Frequency Signal
 Sources 220
 Line-Voltage Regulators 285
 Low-Frequency Oscillators 74
 Microphones 99
 Oscillators 316
 Product-Noise Reduction 39
 Random-Noise Generators 81
 Signal Generators 314
 Stroboscopes 269
 Variac® autotransformers
 295, 311
Service 17
Shaker Control System, Digital ... 72
Shaker, Calibration 101
Short Circuit, 50- Ω coax, GR874 ... 244
 75- Ω coax, GR874 254
 Coaxial, GR900 264
Signal Analyzers 56
 Generators, Standard ... 232-236
 Sources 314
 Sources, High-Frequency ... 219

Slave Stroboscope 280
Slotted Lines 212, 213
Smith Charts 256
Sorting Systems 129
Sorting Systems, Components ... 147
Sound-Analysis Systems 48
Sound and Vibration 21
Sound and Vibration Analyzer 57
Sound and Vibration Recording
 Analyzer 62
Sound-Level Calibrators 38
 Measurement Sets 32
 Meter 26, 40
 Meter, Precision 45
 Recorder 47, 49, 52
Sound Shelter 34
Sources, Signal 314
S Parameter Analyzer, RF 202
Spectrum (1/10-Octave) Analyzer .. 57
 Analyzers 58, 60
 Analyzers, Real-Time 64, 70
 Recorder 49, 52
 Recorder Assemblies 62
Square-Wave Oscillator 77
Standard-Signal Generators .. 232-236
Standard Capacitors, Air 172, 178
 Capacitors, Coaxial .. 176, 177, 178
 Capacitors, Fixed 174, 175
 Capacitors, Mica 179
 Capacitors, Variable 172
 Inductors 197
 Resistance, Coaxial 191
 Resistance, Reference 189
Resistor Decades 184-188
Resistors 190
Standing-Wave Meter 216
Standing-Wave Reflectometer ... 208
Stepped $\frac{1}{2}$ -Octave-Band Analyzer ... 52
Storage Case, GR900 268
Storage Display Unit 66
Strobe Lamp, Replacement ... 278, 279
Strobolume 274
Stroboscopes 269
Stroboslave 280
Strobotac® electronic
 stroboscopes 277, 278
Strobotron, Replacement Lamp ... 278
Stubs, Adjustable, 50- Ω coax,
 GR874 244
Surface-Speed Wheel, Strobe ... 284
Sweep-Frequency Reflectometer ... 208
Sweep-Frequency Synthesizer ... 225
Sweep Network Analyzer, RF 202
Sweep, Oscillator/Recorder 52

SWR Analyzer, Sweep	202
Meter, Sweep	208
Meter, UHF	210
Synthesizers, Frequency	222-227

T

Tables, Decibel	345
Tables, Reactance	342
Tachometers, Stroboscopic	269
Tantalum-Resistor Trim Systems	122, 123, 124
Techware Computer-aided N/C	118
Tee, 50- Ω coax, GR874	248
Tenth-Octave Analyzer	57
Automatic	63
Real-Time	64
Terminations, 50- Ω coax, GR874	244
50- Ω coax, GR900	263
75- Ω coax, GR874	254
75- Ω coax, GR900	267
Testers, Hearing	33
Testers, Logic-Circuit	110, 112, 115
Test Jig	151, 180
Test System, Passive	125
Third-Octave Analyzer	57
Analyzer, Automatic	63
Analyzer, Real-Time	64
Filter	67
Recorder	52
Time and Frequency Meter (Counter)	326, 328

Time-Data Time-Series Analyzers	70
Time-Data Digital Vibration Control System	72
Time Delay, Strobe	283
Time-Series Analyzers	70
Tone-Burst Generator	321
Tool Kit, coax, GR900	268
Tools, Coax, Crimping, GR874	255
Transformers, Adjustable	293
Transformer Test System	135
Transistor Mounts	255
Trigger, Photoelectric	284
Trimmer Systems, Anodize	122, 123, 124
Trim System, Laser	120
Tripod, Microphone	97
Trombone, Air Line, 50- Ω coax, GR874	247
Tube and Rod For 50-, 75- Ω Air Line, GR874	256
Tube and Rod For 50- Ω Air Line, GR900	268
Tuned Amplifier and Null Detector	162
Tuner, 50- Ω coax, GR900	264
Tuning Stubs, 50- Ω coax, GR874	244
TV Strobe Light	274

U

UHF Admittance Meter	210
UHF Preampifier	217
Ultrasonic Oscillator	77
Universal Filter	91

V

Variable Capacitor, Precision	172
Variac® adjustable autotransformers	293
Line-Voltage Regulators	285
Replacement Brushes	312
VHF Preampifier	217
Vibration and Sound	21
Analyzer	57
Calibrator	101
Control System	72
Meter	42
Pickup Preampifiers	95
Pickups and Systems	100
Recording Analyzer	62
Video Strobe Light	274
Voltage Calibrator, ac/dc	92
Control Transformers	293
Divider, Decade	323
Regulators, Line	285
Voltmeter Rectifier/Detector, 50- Ω coax, GR874	249

W

Walsh-Healey Noise	24
Warranty Statement	17
Wave Analyzers	58, 60
Wave Analyzer, Recording	62, 63
Wearable Noise-Exposure Monitor	30
Wheel, Linear-Speed, Strobe	284
Windscreens, Microphone	97
Wire-Wrapping Systems	116

Index by Type Number

CAP Power Cords	336	874-TPD Power Divider	248	1163 Frequency Synthesizer	226
G-S 1703 Recording Audiometer	35	874-U Line Section	248	1164 Frequency Synthesizer	226
M/S 80 Laser Trim System	120	874-UB Terminal Units	243	1165 Frequency Synthesizer	224
M-Series Variac® autotransformers	303	874-UBL Balun	243	1168 Frequency Synthesizer	224
T/D 1923 Time-Series Analyzers	70	874-V Voltmeter Rectifier/Detector	249	1191 Counter	326
U2 Variac® autotransformer	296	874-VCL Variable Capacitor	245	1192-B Counter	328
VB Replacement Brushes (Variac)	312	874-W Terminations, 50- Ω	244	1201-C Power Supply (for 1217-C)	320
W50-P1 Paralleling Choke	312	874-W (75- Ω) Terminations	254	1203-B Power Supply (for 1217-C)	320
W-Series Variac® autotransformers	299	874-X Insertion Unit	250	1211-C Oscillators	228
80 Laser Trim System	120	874-XL Series Inductor	250	1215-C Oscillators	228
274 Adaptors	335	874-Z Stand	255	1217-C Pulse Generator	320
274 Patch Cords	336	880-DCA Precision Directional Coupler	217	1218-BV Oscillator	230
274 Plugs and Jacks	334	890-BT Basic Coaxial Connector	259	1232-A Tuned Amplifier and Null Detector	162
400 ComputerWrap™ Wire-Wrapping System	116	GR900® precision coaxial components	257	1232-P2 Preamplifier	163
480 Rack Adaptors	338	GR900® 75- Ω coaxial components	266	1234 Standing-Wave Meter	216
500 ComputerWrap™ Wire-Wrapping System	116	900 Adaptor Flange	260	1236 I-F Amplifier	215
510 Decade Resistance Units	187	900 Adaptor Kit	261	1237-A VHF/UHF Preamplifier	217
600 ComputerWrap™ Wire-Wrapping System	116	900 Rod and Tube, 50- Ω	268	1238 Detector	159
776 Patch Cords	335	900 Rotatable Centering Ring	260	1240 Bridge Oscillator/Detector	163
777 Adaptors	335	900 Storage Case	268	1241 Heterodyne Detectors	214
GR874® coaxial components	237	900-A Basic Connector Kits, 50- Ω	259	1262-B Power Supply	41
GR874® 75- Ω coaxial components	252	900-BT Basic Precision Connectors (50- Ω)	259	1262-C Power Supply	43
874 Tube and Rod	256	900-BT (75- Ω) Basic Connector	266	1263-C Amplitude-Regulating Power Supply	230
874-A Cable	251	900-C 50- Ω Cable Connectors	260	1264-B Modulating Power Supply	230
874-B Basic 50- Ω Connector	238	900-EL 90° Ell	268	1265-A Adjustable DC Power Supply	196
874-B (75- Ω) Basic Connector	252	900-G Attenuators, 50- Ω	264	1267-B Regulated Power Supply	230
874-BR RF Bridges	256	900-L Air Lines	265	1269-A Power Supply	230
874-C 50- Ω Cable Connectors	239	900-LB Slotted Line	213	1308-A Audio Oscillator and Power Amplifier	76
874-C (75- Ω) Cable Connectors	252	900-LZ Reference Air Lines	265	1309-A Oscillator	77
874-D Adjustable Stubs, 50- Ω	244	900-MP Matching Pad	267	1310-B Oscillator	78
874-EKA Basic Slotted Line Kit	212	900-PKM Panel Mounting Kit	260	1311-A Audio Oscillator	79
874-EL Ell	248	900-Q 50- Ω Adaptors	261	1312 Decade Oscillator	80
874-F Low-Pass Filters	249	900-Q 75- Ω Adaptors	266	1316 Oscillator	158
874-FBL Bias Insertion Unit	250	900-TOC Cleaning Kit	268	1330-A Bridge Oscillator	318
874-G Attenuators, 50- Ω	245	900-TOK Tool Kit	268	1340 Pulse Generator	319
874-G (75- Ω) Fixed Attenuators	254	900-TUA Tuner	264	1346 Audio-Frequency Microvolter	92
874-JR Rotary Joint	248	900-W 50- Ω Terminations and Mismatches	263	1361 Oscillators	230
874-K Coupling Capacitor	250	900-W 75- Ω Termination	267	1362 Oscillators	229
874-L Air Lines, 50- Ω	247	938 Binding Posts	332	1363 Oscillators	229
874-L (75- Ω) Rigid Air Line	254	940 Decade-Inductor Units	199	1381 Random-Noise Generator	81
874-LBB Slotted Line	212	970-Series Potentiometers	337	1382 Random-Noise Generator	81
874-LV Micrometer Vernier	212	1000 Signal-Generator Accessories	236	1383 Random-Noise Generator	83
874-MB Coupling Probe	250	1001-A Standard-Signal Generator	236	1390-B Random-Noise Generator	84
874-ML Component Mount	250	1003 Standard-Signal Generator	232	1390-P2 Pink-Noise Filter	85
874-MP Matching Pad	253	1026 Standard-Signal Generator	234	1396-B Tone-Burst Generator	321
874-MR Mixer/Rectifiers	248	1061 Frequency Synthesizer	222	1403 Standard Air Capacitors	178
874-P 50- Ω Panel Connectors	239	1062 Frequency Synthesizer	222	1404 Reference Standard Capacitor	175
874-P (75- Ω) Panel Connectors	252	1065 Sweeping Frequency Synthesizer	225	1405 Coaxial Capacitance Standards	176
874-Q 50- Ω Adaptors	240	1157-B Scaler (500 MHz)	325	1406 Coaxial Capacitance Standards	177
874-Q (75- Ω) Adaptors	252	1161 Frequency Synthesizer	226	1407 Coaxial Capacitance Standards	178
874-R Patch Cords	251	1162 Frequency Synthesizer	226	1408 Reference Standard Capacitors	174
874-T Tee	248				
874-TO Crimping Tools and Kit	255				

Miscellany

Parts

Rack Adaptors and Sets

Cabinets and Mounting

Mechanical Specifications

Abbreviations

Reactance Charts

Decibel Conversion Tables

Federal Stock Numbers

Index



938 Binding Posts

- wide selection
- gold-plated copper for low thermal emf or nickel-plated brass for economy
- four colors in metal and plastic
- excellent electrical characteristics

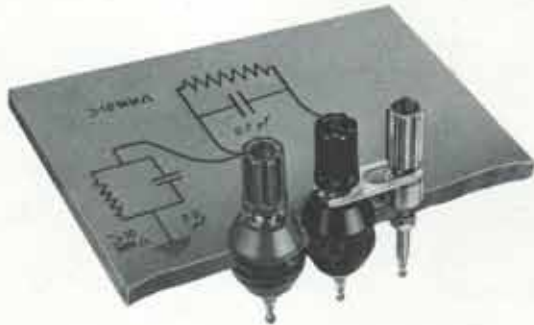

The excellent electrical properties and ingenious mechanical design of the GR 938 Binding Posts provide all the properties needed for modern electronic instruments. Two styles are available: Nickel-plated brass for economy,

and gold-plated copper for high conductivity and low thermal emf with connection to copper wires. Both styles are available with either metal or insulated tops designed for easy hand-tightening, or $\frac{3}{8}$ -in., 12-point wrenches can be used for more permanent connections. The polycarbonate insulation has high insulation resistance and low dissipation factor and is available in red and black, for color coding.

These binding posts can be mounted on metal or non-conducting panels of any thickness up to 0.32 in. (8 mm). There is 0.62-in. clearance between panel insulators when binding posts are mounted at standard spacing, 0.75 in. (19 mm) between centers. Mechanical details and methods of connection are shown in the drawings.

Jack-top The hollow binding post doubles as a banana jack, allowing secure connection even while the nut is loose or clamped onto a wire. The binding post has the same height above a panel as the nonlocking GR874® coaxial connector, the center contact of which will also function as a banana jack. Therefore, a grounded binding post spaced 0.75 in. from a GR874 connector makes a useful combination that will receive either a GR874 connector or a 274-MB double banana plug.

Versatility There is practically universal compatibility among the banana plugs and jacks in the 274-, 777-, and 938-series and adaptors such as 874-MB, -Q2, -Q10, and 900-Q9. Contact resistance, plug to jack, is typically about 1 m Ω .

Methods of Connection



Mechanical Details

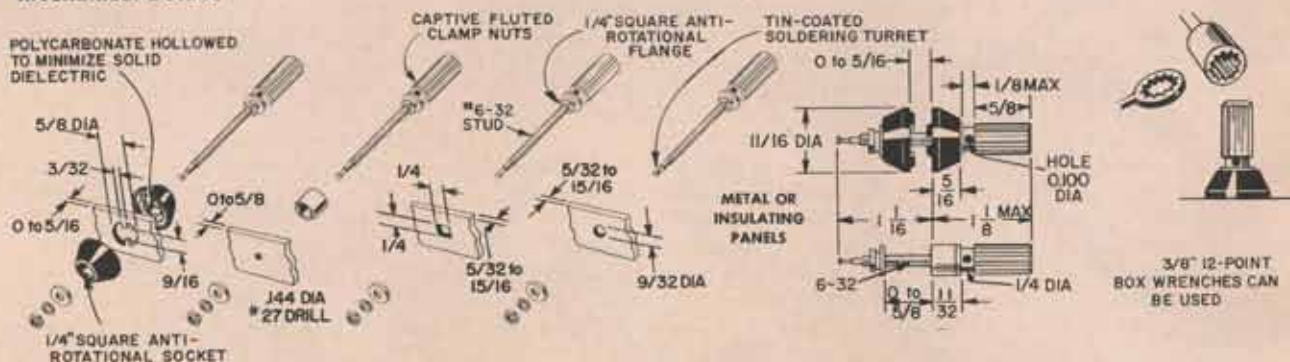

Locking keys in $\frac{3}{8}$ -inch mounting holes can be omitted if only moderate resistance to rotation is needed.

938 Binding Posts

Gold-Plated Copper Binding-Post Assembly

Three general types: With colored top for insulated finger grip, metal top for exterior clip-on connection, and uninsulated for panel (ground) connection. Refer to sketches for methods of connection. Gold-plated copper assures high conductivity and low thermal emf with copper wire. Jack top receives banana plug.

Peak Ratings: Up to 4 kV and 30 A. **BREAKDOWN:** 10 kV pk.
Dissipation Factor, at 1 kHz: < 0.0005.
Mechanical: DIMENSIONS: (see sketches). **NET WEIGHT:** colored top, 0.5 oz (14 g); metal top and uninsulated, 0.65 oz (18 g).

Description	Catalog Number
938 Binding-Post Assembly, Copper:	
938-HB with black top and insulators	0938-9852
938-KR with red top and insulators	0938-9855
938-GB with metal top, black insulators	0938-9842
938-GR with metal top, red insulators	0938-9845
938-GM uninsulated, with toothed spacer	0938-9834

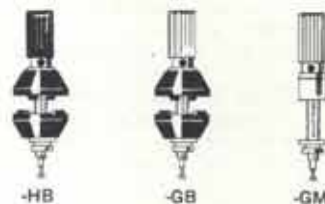

Brass Binding-Post Assemblies

Nickel-plated brass, for strength and economy, otherwise like the gold-plated versions. Three general types: With colored tops for insulated finger grip, metal top for exterior clip-on connection, and uninsulated for panel (ground) connection.

Peak Ratings: Up to 4 kV and 30 A. **BREAKDOWN:** 10 kV pk.
Dissipation Factor, at 1 kHz: < 0.0005.
Mechanical: DIMENSIONS: (See sketches). **NET WEIGHT:** colored top, 0.4 oz (11 g); metal top and uninsulated, 0.5 oz (14 g).

938 Binding-Post Assembly, Brass:	
938-WB with black top and insulators	0938-9872
938-WR with red top and insulators	0938-9882
938-W with metal top, black insulators	0938-9743
938-R with metal top, red insulators	0938-9728
938-P, uninsulated, with toothed spacer	0938-9727



Binding Posts

Jack-top binding posts, with top nuts for the primary clamping function, with mounting nuts and washers, but without panel insulators or toothed spacers. Gold-plated copper or nickel-plated brass.

Mechanical: NET WEIGHT: 938-A, -H, -K, 0.4 oz (11 g); -C, -D, 0.3g (9 g); -G, 0.55 oz (16 g).

938 Binding Posts:	
938-H Black top, copper	0938-9708
938-K Red top, copper	0938-9711
938-G Metal top, copper	0938-9707
938-C Black top, brass	0938-9733
938-D Red top, brass	0938-9734
938-A Metal top, brass	0938-9731



Binding-Post Accessories

Shorting link conveniently makes a direct short circuit between binding posts at standard spacing; remains semi-captive when swung around for open circuit. Panel insulators or toothed spacers convert any of the plain binding posts to insulated or uninsulated (panel-grounded) assemblies, respectively. Use insulators on both front and rear of panel, spacers on front only. Insulators have interdigitating bosses, for panels 0 to 0.32 (8 mm) thick. Double insulators hold pairs of binding posts at 0.75-in. (standard) spacing. Both insulators (polycarbonate) and spacers (brass) have square holes to prevent rotation of posts after assembly.

Mechanical: NET WEIGHT: 0.1 oz (3 g) each, except 938-BB and -BR, 0.1 oz per pair.



938 Accessories:	
938-LG Shorting link, gold-plated brass	0938-9503
938-L Shorting link, nickel-plated brass	0938-9712
938-BB Insulators, black, pair	0938-9818
938-BR Insulators, red, pair	0938-9822
938-YB Double insulators, pair	0938-9873
938-FG Spacer, (toothed) gold-plated	0938-9830
938-F Spacer, (toothed) nickel-plated	0938-9706

Banana Plugs and Jacks

Insulated Double Plug

Versatile Stackable, with jack top. Accommodates wires, cables, component leads, etc from either one side or top (up to 0.2-in. dia through formed strain relief). Metal parts float — although captive — for self alignment of mating plugs and jacks, at standard 0.75-in. spacing. Polarity indicator designates plug usually used for inner conductor, "high" side, or + polarity of the pair. Fully compatible with GR banana plugs and jacks, except 274-NK Shielded Double Plug.

Reliable Safety enhanced by enclosure of all metal parts but the banana pins themselves; even tips of wires are insulated. Rugged socket-head setscrews provide secure fastening for wires (without tendency to split like slotted screws). Low-loss molded styrene body.

Convertible Each banana pin is easily removable for conversion from side wiring to top wiring. Wire can be inserted and clamped with pin in place or removed, as you prefer. Use 0.078-in. hex wrench. Wire diameter up to 0.12 in. (3 mm or AWG 9) is accommodated.

Peak Ratings: Up to 4 kV and 15 A. **BREAKDOWN:** 10 kV pk.
Dissipation Factor, at 1 kHz: < 0.0005.
Net Weight: 0.4 oz (11 g).

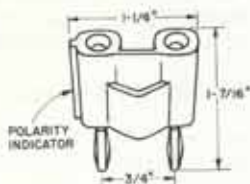

Description

Catalog Number

274-MB Insulated Double Plug

0274-9875

Shielded Double Plug

Double plug in an aluminum case for completely shielded connections to 938 Binding Posts. Accepts cables up to 0.2 in. diameter. Stepped case permits a 938-L(G) Shorting Link to be used between low-terminal binding post and a ground binding post without interfering with proper shielding. High terminal of double plug remains fully shielded. The 274-NK can be locked to binding posts; turning a screw expands one pin inside body of the binding post. This plug terminates the Type 274-NL, 776-A, and 874-R34 Patch Cords.

Peak Ratings: Up to 4 kV and 20 A. **BREAKDOWN:** 10 kV pk.
Dissipation Factor, at 1 kHz: < 0.0005.
Net Weight: 3 oz (85 g).



274-NK Shielded Double Plug

0274-9877

Single Plugs

Nickel-plated brass center pin with 4-leaf beryllium copper spring seats firmly in 274- and 938- series jacks for reliable contact, typically ≈ 1 m Ω . All except 274-P have jack top. Insulated version is like half of double plug (274-MB); pin is removable; strain relief along side accepts wires up to 0.156-in. (4-mm) dia.

Current Rating: 15 A.
Net Weight: 274-P, -DB, 0.2 oz (5.5 g); -U, 0.3 oz (8.5 g).



-DB1



-U

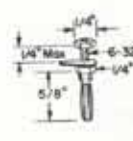

-P

274-Single Plugs

274-DB1 Insulated, black
274-DB2 Insulated, red
274-U Jack top
274-P Solid stud top

0274-9454

0274-9455

0274-9721

0274-9716

Jacks

Nickel-plated brass, for panel mounting. Two lengths, the longer is available as an assembly with insulators (938-BB, -BR) or can be used with separate toothed spacers (938-F, -FG). Mounting hardware supplied.

Current Rating: 15 A.
Net Weight: Assembly, 0.4 oz (11 g); long version 0.3 oz (8.5 g); short, 0.15 oz (4.2 g).

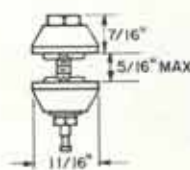

-XB



938-J



274-J

Jacks

938-XB Insulated assembly black
938-XR Insulated assembly, red
938-J Long jack
274-J Short jack

0938-9877

0938-9878

0938-9710

0274-9710

Adaptors

Refer also to the 874-MB and 874-Q series of adaptors.

GR874® Connector and Binding Posts

Connects to GR874 coaxial port from double (or 2 single) 274-series banana plug or patch cord. Has versatility of 938-series binding posts.

Net Weight: 2 oz (57 g).



Fits Type
274 Double-
Plug Patch Cords

Description

874-Q2 Adaptor

Catalog
Number

0874-9870

GR874® Connector and Banana Plugs

Connects to a standard-spaced pair of jack-top binding posts (938) from GR874® coaxial connector, with good shielding. Similar to 274-NK plug; can be locked to one post for semi-permanent installation, by a turn of a screw.

Net Weight: 2 oz (57 g).



777-Q3 Adaptor

0777-9703

BNC Jack and Banana Plugs

Connects BNC cable (plug) to standard pair of jack-top binding posts, with good shielding. Adaptor will lock to one post for semi-permanent installation, by a turn of a screw.

Net Weight: 3 oz (85 g).

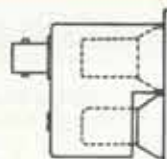

Fits standard
3/4-in.-spaced
binding posts

274-QBJ Adaptor

0274-9884

BNC Jack and Phone Plug

Connects BNC cable (plug) to phone jack.

Net Weight: 2 oz (57 g).



777-Q4 Adaptor

0777-9704

Patch Cords and Power Cords

(Refer also to the 874-R series of coaxial patch cords; they have superior SWR and other characteristics of value at high frequencies.)

Shielded Banana Plugs with Cable and BNC Plug

50- Ω cable connects between jack-top binding-post pair and BNC jack, with good shielding. Can be locked in place. (Refer to description of 274-NK Shielded Double Plug.)

Mechanical: LENGTH: 3 ft (920 mm). PLUG SPACING: 0.75 in., standard (19 mm). NET WEIGHT: 3 oz (85 g).



776-A Patch Cord

0776-9701

BNC Plug with Cable and GR874® Connector

50- Ω shielded cable connects between BNC jack and GR874 coaxial connector. The GR874 end has the space-saving hammerhead shape (axis perpendicular to cable), so convenient when your cable runs parallel to the instrument panel.

Mechanical: LENGTH: 3 ft. (920 mm). NET WEIGHT: 3 oz (85 g).



776-B Patch Cord

0776-9702

BNC Plugs with Cable

50- Ω shielded cable connects between BNC jacks (popular panel-mounted connectors).

Mechanical: LENGTH: 3 ft (920 mm). NET WEIGHT: 2 oz (57 g).

Description

776-C Patch Cord

Catalog Number

0776-9703



Shielded Double Banana Plugs with Cable

Fully shielded cable and connectors plug conveniently into pairs of 938 binding posts at standard spacing. Can be locked in place. (Refer to description of 274-NK Shielded Double Plug.)

Mechanical: LENGTH: 3 ft (920 mm). NET WEIGHT: 6 oz (170 g).

274-NL Shielded Double-Plug Patch Cord

0274-9883

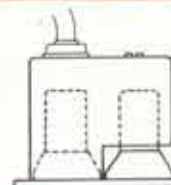

Banana Plugs with Cable

Shielded wire with double plugs is ideal for jack-top binding posts at standard spacing; single-conductor with single plugs fits any banana jack — 938- and 274-series, 874-Q2, -MB, etc. Right-angle (hammerhead), in-line, and single versions are stackable in any sequence. Plugs fit firmly in jacks for mechanical stability (not dependent on springs); contact resistance, about 1 m Ω . Double plugs have polarity indicator, corresponding to inner conductor of cable. Plug bodies are molded cellulose-acetate-butyrate for outstanding durability; the individual pins of the double plugs are, in addition, first encapsulated in polystyrene for superior insulation. Single versions, wire size: 18 AWG.

Mechanical: LENGTH: 3 ft (920 mm). NET WEIGHT: Double, 3 oz (85 g); single, 1.5 oz (43 g).

Description

Banana-Plug Patch Cords
 274-NQ Double, in-line
 274-NP Double, right-angle
 274-LLB Single, black
 274-LLR Single, red

Catalog Number

0274-9860
 0274-9880
 0274-9468
 0274-9492

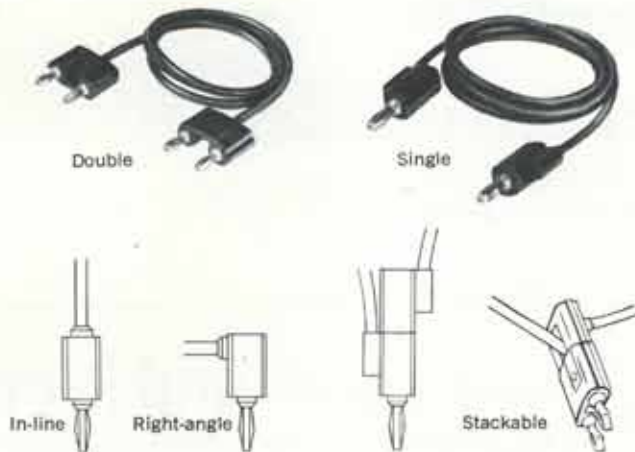

Power Cords

Well insulated power cable has connector bodies molded integrally with jacket. Will connect from standard power-line outlet to instrument or other electrical device. Similar cables can be stacked with their hammerheads engaged (to accommodate several loads); 2 or more CAP-22 or CAP-35 cords can be connected in series to reach 14 ft or more. Both 2- and 3-wire versions. Socket at load end of 2-wire version fits either 2-pin plug or 2 flat pins of CAP-22.

3-wire versions At power-source end, these cords have 1 round and 2 flat pins, as well as the corresponding socket. This connector is designed for 125-V operation, conforming to the standard for "Grounding Type Attachment Plug Caps and Receptacles," ANSI C73.11-1963. Cord is type SVT, rated by Underwriters Laboratories for 300 V, 7 A rms. At the load end, CAP-22 has a similar socket, permitting series connection.

International At the load end of the IEC version, however, the socket fits 3 flat pins, conforming to the International Electrotechnical Commission's Publication 320. The design has been adopted world-wide for electronic instrumentation and is rated for 250 V, 6 A. Other advantages are convenience and safety (the instrument plug is recessed or shrouded).

For special requirements, you can cut off the hammerhead connector and replace it with your own.

Ratings: 125 V, 7 A. WIRE SIZE: No. 18 AWG.

Mechanical: LENGTH: 7 ft (2.13 m). NET WEIGHT: 7 oz (0.2 kg).



IEC Power Cord, 3-wire
 CAP-22 Power Cord, 3-wire
 CAP-35 Power Cord, 2-wire

4200-9625
 4200-9622
 4200-9635

970-Series Potentiometers

These potentiometers are moderately priced controls with high-quality performance. They can be used at dc, throughout the audio- and ultrasonic-frequency ranges, and, in many applications, at low radio frequencies. When ganged, the 970-Series Potentiometers retain their low-

capacitance characteristics. Units are designed to be nested with molded spacing rings, stacked on a long shaft, and held together with thin metal clamping rings and tie rods. This assembly allows units to be set in any desired phase relationship.

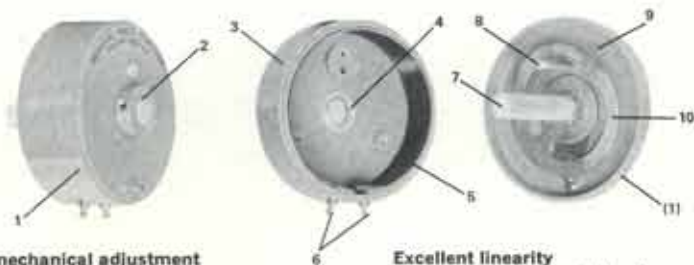

Simple mechanical adjustment
Excellent mechanical stability
Excellent Repeatability

Projecting hub permits adjustment of shaft with respect to contact brush while case is closed. Hub rotates in a recessed brass insert molded into cover to form a metal-to-metal bearing close to plane of brush.

A second bearing is provided by a nylon-graphite insert to guide shaft into base.

Excellent linearity
Low temperature coefficient
Low inductance

Uniformly wound, low-temperature-efficient resistance element on a thin, phenolic-laminate mandrel firmly cemented into body molding.

Low noise

Firm clean track
Precious-metal contact
Uniform contact pressure

High leakage resistance
Low capacitance to ground

Glass-reinforced-polyester shaft
New diallyl-phthalate dust-proof cover
New diallyl-phthalate body

High resolution

Small-diameter brush of precious-metal alloy

High reliability

Turret terminals are both riveted to end of clamps and soldered to ends of winding and to silver-plated, spring-bronze contact take-off in cover so that none of the fixed internal connections depends on pressure alone.

Brush arm and spring are combined into a single stamping of spring-temper phosphor-bronze.

Screw that holds cover to base passes through a horseshoe-shaped slot in brush arm to serve as a rotational stop that exerts no force on brush.

(All dimensions in inches)		Type	Nominal Resistance Ohms	Temperature Coefficient of Resistance	Resolution	Catalog Number
<p>Wt: Approx 1/2 oz (14 g)</p>	971-B	2	±0.07%	<1%	0971-9702	
	971-C	5	±0.07	<1	0971-9703	
	971-D	10	±0.002	<1	0971-9704	
	971-E	20	±0.002	<1	0971-9705	
	971-F	50	±0.002	<0.5	0971-9706	
	971-G	100	±0.002	<0.5	0971-9707	
	971-H	200	±0.002	<0.5	0971-9708	
	971-J	500	±0.002	<0.5	0971-9710	
	971-K	1000	±0.002	<0.5	0971-9711	
	971-L	2000	±0.002	<0.5	0971-9712	
	971-M	5000	±0.002	<0.2	0971-9713	
	971-N	10,000	±0.002	<0.2	0971-9714	
	971-P	20,000	±0.002	<0.2	0971-9716	
<p>Wt: Approx 1 oz (28 g)</p>	973-C	5	±0.07	<0.5	0973-9703	
	973-D	10	±0.07	<0.5	0973-9704	
	973-E	20	±0.002	<0.5	0973-9705	
	973-F	50	±0.002	<0.5	0973-9706	
	973-G	100	±0.002	<0.5	0973-9707	
	973-H	200	±0.002	<0.5	0973-9708	
	973-J	500	±0.002	<0.2	0973-9710	
	973-K	1000	±0.002	<0.2	0973-9711	
	973-L	2000	±0.002	<0.2	0973-9712	
	973-M	5000	±0.002	<0.2	0973-9713	
	973-N	10,000	±0.002	<0.1	0973-9714	
973-P	20,000	±0.002	<0.1	0973-9716		
973-Q	50,000	±0.002	<0.1	0973-9717		
<p>Wt: Approx 3 oz (85 g)</p>	975-J	500	±0.002	<0.2	0975-9710	
	975-K	1000	±0.002	<0.2	0975-9711	
	975-L	2000	±0.002	<0.2	0975-9712	
	975-M	5000	±0.002	<0.2	0975-9713	
	975-N	10,000	±0.002	<0.1	0975-9714	
	975-P	20,000	±0.002	<0.1	0975-9716	
	975-Q	50,000	±0.002	<0.05	0975-9717	
	975-R	100,000	±0.002	<0.05	0975-9718	

Type	Effective Electrical Rotation	Total Mechanical Rotation	Standard Resistance Tolerance	Average Torque oz/in.	Independent Linearity	Power Rating at 0°C ambient temp*	
						Mounted on Alum Panel	Suspended in Air
971	315° ± 5°	330° ± 5°	±5%	1.8	±2%	5.6 W	3.5 W
973	320° ± 5°	330° ± 5°	±5%	2.5	±1%	8.4 W	5.9 W
975	320° ± 2°	330° ± 5°	±2%	4	±0.5%	13.4 W	10.7 W

* Power rating decreases linearly with rising ambient temperature to zero at 100°C.

⊕ Federal stock numbers are listed before the Index.

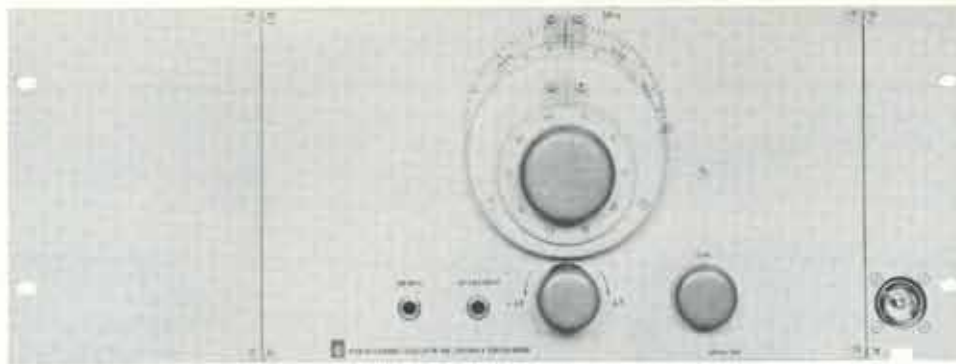

Types 1218-BV and 1267 shown rack-mounted with 0481-9846 Rack-Adaptor Set.

Rack Adaptors and Sets

Listed below are the instrument-panel extensions and hardware, supplied in complete sets, for converting bench-model instruments for mounting in standard 19-inch relay racks. In many cases, these instruments are offered in a choice of rack or bench mountings and should be ordered initially according to mounting requirements, as complete cabinets and hardware are included. When

retrofitting is necessary, the adaptors below should be ordered.

Instruments missing from this list may require more extensive changes than can be done by simple kits or may be unavailable for rack mounting other than by special order. In these cases, a General Radio Regional Center or representative should be consulted.

Instrument	Height (in.)	Catalog Number
1157-B	3½	0480-9722
1192	3½	0480-9722
1192-Z	3½	0480-9702
1192 + 1157-B	3½	0480-9702
1211-C	7	0480-9848
1211-C + 1263 or 1264	7	0481-9846
1211-C + 1267 or 1269	7	0481-9842
1215-C	7	same as 1211's
1217-C	7	0480-9986
1218-BV	7	0481-9842
1218-BV + 1263 or 1264	14	0482-9842
1218-BV + 1267	7	0481-9846
1232-A	5¼	0480-9838
1232-A + 1311	5¼	0480-9836
1232-A + 1232-P1 + 1311	5¼	0480-9837
1236	7	0480-9848
1236 with oscillator		see 1241's
1240-A	5¼	0480-9836
1240-AP	5¼	0480-9837
1241-9701, 1241-9703	7	0480-9670
1241-9705	14	0480-9671 and -9848

Instrument	Height (in.)	Catalog Number
1263	7	0480-9848
1264	7	0480-9848
1309-A	5¼	0480-9838
1310-B	5¼	0480-9838
1311	5¼	0480-9838
1311 + 1232-A	5¼	0480-9836
1311 + 1232A + 1232-P1	5¼	0480-9837
1340	5¼	0480-9723
1361-A	7	same as 1211's
1362	7	same as 1211's
1363	7	same as 1211's
1381	3½	0480-9722
1382	3½	0480-9722
1390-B	7	0480-9842
1396-B	5¼	0480-9723
1413	5¼	0480-9703
1433 4-dial	3½	0480-2080
5-dial	3½	0480-2060
6-dial	3½	0480-2020
7-dial	5¼	0480-2091
1436	3½	0480-9722
1455 4-dial	3½	0480-2060
5-dial	3½	0480-2020
1491	8¼	0480-9705
1560-P62	3½	0480-9742
1840-A	3½	0480-9822

Cabinets and Mounting

General Radio instrument cabinets are rugged, attractive, and versatile. Heavy-gauge aluminum and tough finishes combine to keep GR instruments operating and looking like new through many years of hard service.

We use five basic cabinet types: (1) Pedestal cabinets, for bench mounting of instruments with a standard 19-

inch-wide panel, (2) rack cabinets, for installation in standard racks, (3) Flip-Tilt cases*, for portable instruments, (4) convertible-bench cabinets, for smaller laboratory instruments, and (5) lab-bench cabinets, for laboratory standards, decade boxes, and similar instruments.

* Patent Number 2,966,257.

Rack or Bench Instruments

General Radio instruments with 19-inch-wide front panels are supplied in a choice of mounting for either relay-rack installation or for use on a bench where portability counts. All cabinets, whether for rack or bench use, are effective shields preventing mutual interference with other nearby instruments.

Newer instrument models are mounted in either a "pedestal" cabinet for bench use or a "rack" cabinet, each specifically designed for its particular function. The pedestal cabinet raises the instrument slightly on a recessed pedestal that provides a handhold for lifting. In smaller instruments, the pedestal is the base for a tilting mechanism and, inside, provides storage space for instruction manuals and small accessories. For convenient

carrying, larger instruments and assemblies in the pedestal cabinet have hinged heavy-duty handles recessed into the sides near the top of the cabinet. Slides in both pedestal and rack cabinets permit easy removal for servicing. The rack cabinet has all the provisions for mounting the instrument in a standard 19-inch relay rack with universal mounting-hole spacing per EIA Standard RS-310 and includes rear-support brackets as well.

Flip-Tilt Cases

General Radio's exclusive Flip-Tilt case includes three main parts: the instrument cabinet, a captive cover, and a carrying-handle and lever assembly. In use, the instrument sits on its cover as a base. To open the cabinet, you push down on the carrying handle. The lever action of the handle raises the cabinet from the cover. The cabinet



Pedestal Cabinet



Rack Cabinet



Flip-Tilt case in one of its many operating positions. Rubber gasket provides friction to allow almost any tilt angle.

is then easily flipped into position for operation. The operating position may be fully open or tilted at almost any angle. A rubber seal around the edge of the cover provides friction to hold the cabinet in a tilted position. When the instrument is closed, the same gasket provides a seal for the enclosure. Accessories and instruction manual are conveniently stored in the Flip-Tilt cover.

Certain Flip-Tilt instruments are also available in standard relay-rack cabinets; most other Flip-Tilt instruments are available adapted for rack mounting. In such adaptations, the Flip-Tilt case (minus cover and handle) is neatly and securely mounted in a relay-rack adaptor panel.

Convertible-Bench Cabinets

Small and medium-sized instruments commonly used on the bench are housed in GR's unique convertible-bench cabinet, designed primarily for the bench but offering quick relay-rack adaptability.

The convertible-bench cabinet is made of sturdy aluminum finished in GR medium gray wrinkle. The dust cover can be readily removed.

Instruments with panel meters can be tilted to a convenient angle.

Conversion for relay-rack mounting is easy: simply attach matching panel extensions by means of screws to the instrument and to the relay rack.

Lab-Bench Cabinets

Lab-bench cabinets are simple enclosures used primarily for laboratory standards and decade boxes. Two U-shaped pieces of $\frac{3}{8}$ -inch extruded aluminum are strip-locked together to form the sides; an aluminum bottom plate and $\frac{3}{8}$ -inch aluminum panel complete the enclosure. The result is a cabinet well shielded, structurally solid, and efficiently manufactured.

Other Cabinets

While most General Radio instruments are housed in the five cabinets described above, several other types of mounting are used to serve the special demands of particular instruments. These range from the pocket-sized cases used for certain portable sound-measuring instruments to the specialized structures of a slotted line or an admittance meter.

Accessory mounting hardware, such as end frames, relay-rack supports, and relay-rack adaptor panels, may be ordered separately if you wish to convert from one type of mounting to another. Many of these accessories are listed along with the related instruments; there is a catalog page listing rack adaptors. Further information on such hardware, dimensions, etc, is available on request.



Convertible-bench instruments tilt on extendible balls for easy viewing of front panels. Panel extensions are used for rack mount.



This precision capacitor is given the excellent shielding and trim appearance of the lab-bench cabinet, characterized by the strip-locked sides (as shown at the right in the photograph).

Definitions of Mechanical Specifications

Dimensions

All dimensions are over-all, except depth of rack models, and are given in decimal inches and millimeters (1 in. = 25.4 mm).

Bench Instruments

Width: Includes panel and cabinet.

Height: Includes pedestal or feet.

Depth: Includes any protrusions on front and rear panels. Does not include cable clearance (usually about 3 in. or 77 mm).

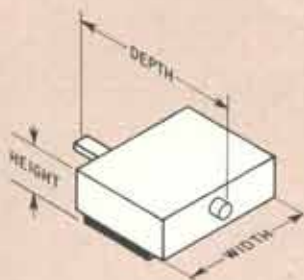

Portable Instruments

Width: Case closed; includes handle or other protrusions.

Height: Includes handle and feet, if any.

Depth: Over-all.

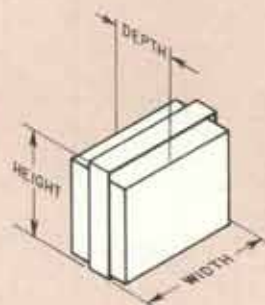

Rack Instruments

Width: Includes front panel only.

Height: Includes front panel only.

Depth: Behind rear surface of front panel; includes any protrusions on rear panel but does not include cable radii (usually about 3 in. or 77 mm), nor any protrusions on front panel.

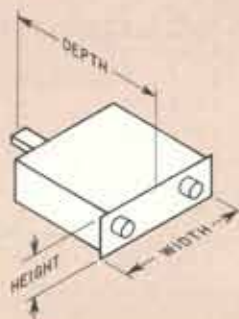

Unusual Shapes

All dimensions are maximum, including any protrusions, but excluding cords or cables.

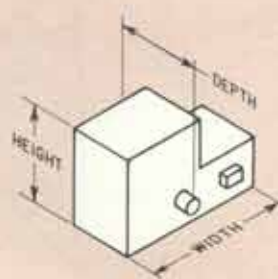
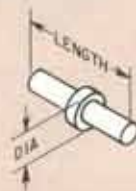

Weight

All weights are in ounces or pounds and grams or kilograms (1 oz = 28.35 g; 1 lb = 0.454 kg).

Net Weight: Net weight includes the weight of the instrument and its cabinet, including any rack-mounting hardware. Where options are listed for an instrument, the net weight is the weight for an instrument containing the heaviest combination of options.

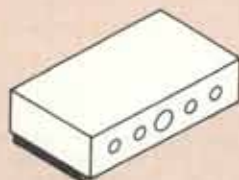

Shipping Weight: Shipping weight includes the net weight of the instrument plus the weight of all accessories supplied, power cord (if any), and packing materials required for shipment in the U. S. and Canada.

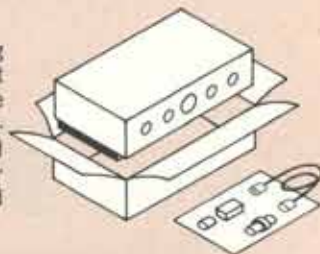

Reactance Chart

Always use corresponding scales

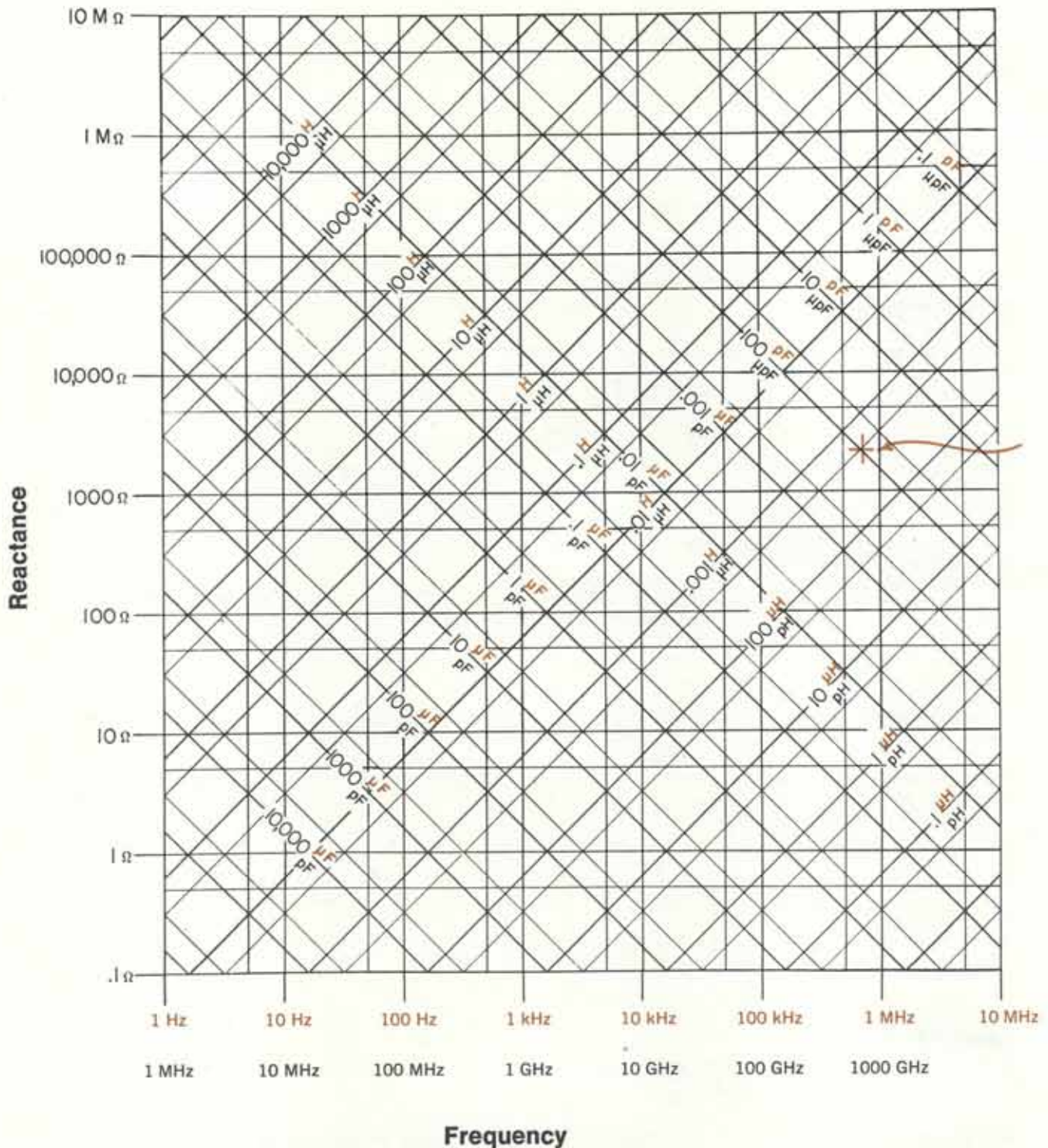

FIGURE 1

Figure 1 is the complete chart, used for rough calculations. Figure 2, which is a single decade of Figure 1 enlarged approximately 7 times, is used where two or three significant figures are to be determined.

To Find Reactance

Enter the charts vertically from the bottom (frequency) and along the lines slanting upward to the left (capacitance) or to the right (inductance). Corresponding scales (color or

black) must be used throughout. Project horizontally to the left from the intersection and read reactance.

To Find Resonant Frequency

Enter the slanting lines for the given inductance and capacitance. Project downward and read resonant frequency from the bottom scale. Corresponding scales (color or black) must be used throughout.

Reactance Chart

Always obtain approximate value from Figure 1 before using Figure 2

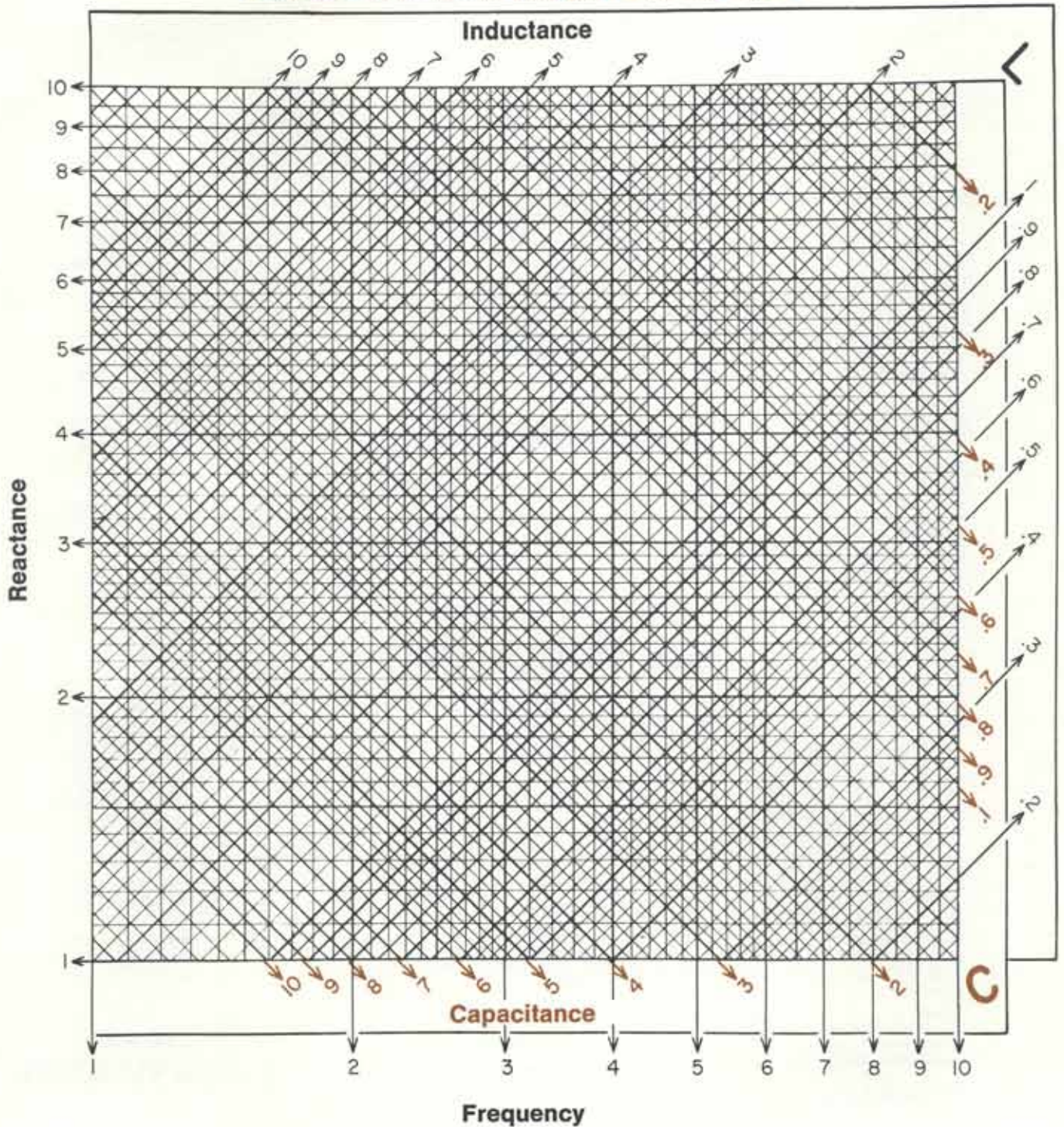

FIGURE 2

Example: The point indicated in Figure 1 corresponds to a frequency of about 700 kHz and an inductance of 500 μH , or a capacitance of 100 pF, giving in either case a reactance of about 2000 ohms. The resonant frequency of a circuit containing these values of inductance and capacitance is, of course, 700 kHz, approximately.

Use of Figure 2

Figure 2 gives additional precision but does not place the decimal point, which must be located from a preliminary entry on Figure 1. Since the chart necessarily requires two logar-

ithmic decades for inductance and capacitance for every single decade of frequency and reactance, unless the correct decade for L and C is chosen, the calculated values of reactance and frequency will be in error by a factor of 3.16. In Figure 2, the capacitance scale is color; inductance scale is black.

Example: (Continued) The reactance corresponding to 500 μH or 100 pF is 2230 ohms at 712 kHz, their resonant frequency.

Abbreviations, Symbols and Prefixes

In this catalog, as in other General Radio publications, our use of symbols, prefixes, and abbreviations follows the recommendations of the International Electrotechnical Commission, the American National Standards Institute, Inc., the Institute of Electrical and Electronics Engineers, and other scientific and engineering organizations. Where there is not agreement among these groups, we generally choose the usage favored by the majority.

ABBREVIATIONS AND SYMBOLS

a	atto (10^{-18})
A	ampere
Å	angstrom
ac	alternating current
afc	automatic frequency control
a-m	amplitude modulation
ANSI	American National Standards Institute, Inc.
APS	American Physical Society
ASA	Acoustical Society of America
ASTM	American Society for Testing and Materials
avc	automatic volume control
avg	average
B	susceptance
bar	bar (10^5N/m^2)
BCD	binary-coded decimal
c	speed of light, centi (10^{-2})
C	capacitance, coulomb
$^{\circ}\text{C}$	degrees Celsius (Centigrade)
cd	candela
CIF	cost, insurance, freight
CML	current-mode logic
COD	cash on delivery
cw	continuous wave
d	deci (10^{-1})
D	dissipation factor
da	deka (10)
dB	decibel
dBm	decibel referred to one milliwatt
dc	direct current
DCTL	direct-coupled transistor logic
dia	diameter
DTL	diode-transistor logic
DUT	device under test
e	electronic charge
E	voltage
EIA	Electronic Industries Association
emf	electromotive force
F	farad, Faraday
$^{\circ}\text{F}$	degrees Fahrenheit
f	frequency, femto (10^{-15})
fm	frequency modulation
FOB	free on board
G	conductance, giga (10^9)
g	gram, gravitational constant
g _m	transconductance
H	henry
h	hour, Planck's constant, hecto (10^2)
hf	high frequency
h _r	forward current-transfer ratio
h _i	short-circuit input impedance

h _o	open-circuit output admittance
h _r	reverse voltage-transfer ratio
Hz	hertz (cycle per second)
HTL	hearing threshold level
I	current
IC	integrated circuit
ID	inside diameter
IEC	International Electrotechnical Commission
IEEE	Institute of Electrical and Electronics Engineers
i-f	intermediate frequency
in.	inch
ISA	Instrument Society of America
ISO	International Standards Organization
j	$\sqrt{-1}$
J	joule
k	kilo (10^3)
$^{\circ}\text{K}$	degrees Kelvin
l	liter (10^{-3}m^3)
L	inductance
lb	pound
LC	inductance-capacitance
lm	lumen
log	logarithm
lx	lux
m	meter, milli (10^{-3})
M	mega (10^6)
max	maximum
mbar	millibar
mil	0.001 inch
min	minimum, minute
mo	month
n	nano (10^{-9})
N	newton
oz	ounce
P	page, parallel (as L _p), pico (10^{-12})
P	poise ($10^{-1}\text{N} \cdot \text{s}/\text{m}^2$)
PF	power factor
ppm	parts per million
pps	pulses per second
pk-pk	peak-to-peak
PRF	pulse repetition frequency
Q	quality factor (storage factor)
R	resistance
®	registered trademark
rad	radian
RC	resistance-capacitance
RCTL	resistor-capacitor-transistor logic
re	referred to
rf	radio frequency
RH	relative humidity
rms	root-mean-square

rpm	revolutions per minute
RTL	resistor-transistor logic
s	second, series (as L _s)
shf	super-high frequency
sq	square
sync	synchronous, synchronizing
T	period, Tesla, tera (10^{12})
t	time
TTL	transistor-transistor logic
TSA	times-series analysis
uhf	ultra-high frequency
v	velocity
V	volt
VA	volt ampere
vhf	very-high frequency
vlf	very-low frequency
W	watt
Wb	Weber
wt	weight
X	reactance
Y	admittance
yf	year
Z	impedance
α	short-circuit forward current-transfer ratio (common base)
β	short-circuit forward current-transfer ratio (common emitter)
Γ	reflection coefficient
Δ	increment
δ	loss angle
θ	phase angle
λ	wavelength
μ	micro (10^{-6})
Ω	ohm
∅	mho
ω	angular velocity (2πf)

PREFIXES

Orders of magnitude from 10^{-18} to 10^{12} are designated by the following prefixes:

Order	Prefix	Symbol
10^{12}	tera	T
10^9	giga	G
10^6	mega	M
10^3	kilo	k
10^2	hecto	h
10	deka	da
10^{-1}	deci	d
10^{-2}	centi	c
10^{-3}	milli	m
10^{-6}	micro	μ
10^{-9}	nano	n
10^{-12}	pico	p
10^{-15}	femto	f
10^{-18}	atto	a

Decibel Conversion Tables

In communications systems the ratio between any two amounts of electric or acoustic power is usually expressed in units on a logarithmic scale. The decibel (1/10th of the bel) on the briggsian or base-10 scale and the neper on the napierian or base-e scale are in almost universal use for this purpose.

Since voltage and current are related to power by impedance, both the decibel and the neper can be used to express voltage and current ratios, if care is taken to account for the impedances associated with them. In a similar manner the corresponding acoustical quantities can be compared.

From Table I and Table II on the following pages conversions can be made in either direction between the number of decibels and the corresponding power, voltage, and current ratios. Both tables can also be used for nepers by application of a conversion factor.

Decibel — The number of decibels N_{dB} corresponding to the ratio between two amounts of power P_1 and P_2 is

$$N_{dB} = 10 \log_{10} \frac{P_1}{P_2}$$

When two voltages E_1 and E_2 or two currents I_1 and I_2 operate in identical impedances,

$$N_{dB} = 20 \log_{10} \frac{E_1}{E_2} \quad \text{and} \quad N_{dB} = 20 \log_{10} \frac{I_1}{I_2}$$

If E_1 and E_2 and I_1 and I_2 operate in unequal impedances,

$$N_{dB} = 20 \log_{10} \frac{E_1}{E_2} + 10 \log_{10} \frac{Z_2}{Z_1} + 10 \log_{10} \frac{k_1}{k_2}$$

$$\text{and} \quad N_{dB} = 20 \log_{10} \frac{I_1}{I_2} + 10 \log_{10} \frac{Z_1}{Z_2} + 10 \log_{10} \frac{k_1}{k_2}$$

where Z_1 and Z_2 are the absolute magnitudes of the corresponding impedances and k_1 and k_2 are the values of power factor for the impedances. E_1 , E_2 , I_1 , and I_2 are also the absolute magnitudes of the corresponding quantities. Note that Table I and Table II can be used to evaluate the impedance and power factor terms, since both are similar to the expression for power ratio.

Neper — The number of nepers N_{np} corresponding to a power ratio $\frac{P_1}{P_2}$ is

$$N_{np} = \frac{1}{2} \log_e \frac{P_1}{P_2}$$

For voltage ratios $\frac{E_1}{E_2}$ or current ratios $\frac{I_1}{I_2}$ working in identical impedances,

$$N_{np} = \log_e \frac{E_1}{E_2} \quad \text{and} \quad N_{np} = \log_e \frac{I_1}{I_2}$$

Relations Between Decibels and Nepers

Multiply decibels by 0.1151 to find nepers
multiply nepers by 8.686 to find decibels

TO FIND VALUES OUTSIDE THE RANGE OF CONVERSION TABLES

Table I: Decibels to Voltage and Power Ratios

Number of decibels positive (+): Subtract +20 decibels successively from the given number of decibels until the remainder falls within range of Table I. To find the voltage ratio, multiply the corresponding value from the right-hand voltage-ratio column by 10 for each time you subtracted 20 dB. To find the power ratio, multiply the corresponding value from the right-hand power-ratio column by 100 for each time you subtracted 20 dB.

Example — Given: 49.2 dB

$$49.2 \text{ dB} - 20 \text{ dB} - 20 \text{ dB} = 9.2 \text{ dB}$$

Voltage ratio: 9.2 dB → 2.884

$$2.884 \times 10 \times 10 = 288.4$$

Power ratio: 9.2 dB → 8.318

$$8.318 \times 100 \times 100 = 83180$$

Number of decibels negative (—): Add +20 decibels successively to the given number of decibels until the sum falls within the range of Table I. For the voltage ratio, divide the value from the left-hand voltage-ratio column by 10 for each time you added 20 dB. For the power ratio, divide the value from the left-hand power-ratio column by 100 for each time you added 20 dB.

Example — Given: -49.2 dB

$$+49.2 \text{ dB} + 20 \text{ dB} + 20 \text{ dB} = -9.2 \text{ dB}$$

Voltage ratio: -9.2 dB → 0.3467

$$0.3467 \times 1/10 \times 1/10 = 0.003467$$

Power ratio: -9.2 dB → 0.1202

$$0.1202 \times 1/100 \times 1/100 = 0.0001202$$

Table II: Voltage Ratios to Decibels

For ratios smaller than those in table — Multiply the given ratio by 10 successively until the product can be found in the table. From the number of decibels thus found, subtract +20 decibels for each time you multiplied by 10.

Example — Given: Voltage ratio = 0.0131

$$0.0131 \times 10 \times 10 = 1.31$$

From Table II, 1.31 → 2.345 dB

$$2.345 \text{ dB} - 20 \text{ dB} - 20 \text{ dB} = -37.655 \text{ dB}$$

For ratios greater than those in table — Divide the given ratio by 10 successively until the remainder can be found in the table. To the number of decibels thus found, add +20 dB for each time you divided by 10.

Example — Given: Voltage ratio = 712

$$712 \times 1/10 \times 1/10 = 7.12$$

From Table II, 7.12 → 17.050 dB

$$17.050 \text{ dB} + 20 \text{ dB} + 20 \text{ dB} = 57.050 \text{ dB}$$

GIVEN: Decibels

Table I

TO FIND: Power and $\left\{ \begin{matrix} \text{Voltage} \\ \text{Current} \end{matrix} \right\}$ Ratios

TO ACCOUNT FOR THE SIGN OF THE DECIBEL

For positive (+) values of the decibel — Both voltage and power ratios are greater than unity. Use the two right-hand columns.

For negative (-) values of the decibel — Both voltage and power ratios are less than unity. Use the two left-hand columns.

Example— Given: ± 9.1 dB; Find:

	Power Ratio	Voltage Ratio
+9.1 dB	8.128	2.851
-9.1 dB	0.1230	0.3508

← -dB+ →					← -dB+ →				
Voltage Ratio	Power Ratio	dB	Voltage Ratio	Power Ratio	Voltage Ratio	Power Ratio	dB	Voltage Ratio	Power Ratio
1.0000	1.0000	0	1.000	1.000	.5623	.3162	5.0	1.778	3.162
.9886	.9772	.1	1.012	1.023	.5559	.3090	5.1	1.799	3.236
.9772	.9550	.2	1.023	1.047	.5495	.3020	5.2	1.820	3.311
.9661	.9333	.3	1.035	1.072	.5433	.2951	5.3	1.841	3.388
.9550	.9120	.4	1.047	1.096	.5370	.2884	5.4	1.862	3.467
.9441	.8913	.5	1.059	1.122	.5309	.2818	5.5	1.884	3.548
.9333	.8710	.6	1.072	1.148	.5248	.2754	5.6	1.905	3.631
.9226	.8511	.7	1.084	1.175	.5188	.2692	5.7	1.928	3.715
.9120	.8318	.8	1.096	1.202	.5129	.2630	5.8	1.950	3.802
.9016	.8128	.9	1.109	1.230	.5070	.2570	5.9	1.972	3.890
.8913	.7943	1.0	1.122	1.259	.5012	.2512	6.0	1.995	3.981
.8810	.7762	1.1	1.135	1.288	.4955	.2455	6.1	2.018	4.074
.8710	.7586	1.2	1.148	1.318	.4898	.2399	6.2	2.042	4.169
.8610	.7413	1.3	1.161	1.349	.4842	.2344	6.3	2.065	4.266
.8511	.7244	1.4	1.175	1.380	.4786	.2291	6.4	2.089	4.365
.8414	.7079	1.5	1.189	1.413	.4732	.2239	6.5	2.113	4.467
.8318	.6918	1.6	1.202	1.445	.4677	.2188	6.6	2.138	4.571
.8222	.6761	1.7	1.216	1.479	.4624	.2138	6.7	2.163	4.677
.8128	.6607	1.8	1.230	1.514	.4571	.2089	6.8	2.188	4.786
.8035	.6457	1.9	1.245	1.549	.4519	.2042	6.9	2.213	4.898
.7943	.6310	2.0	1.259	1.585	.4467	.1995	7.0	2.239	5.012
.7852	.6166	2.1	1.274	1.622	.4416	.1950	7.1	2.265	5.129
.7762	.6026	2.2	1.288	1.660	.4365	.1905	7.2	2.291	5.245
.7674	.5888	2.3	1.303	1.698	.4315	.1862	7.3	2.317	5.370
.7586	.5754	2.4	1.318	1.738	.4266	.1820	7.4	2.344	5.495
.7499	.5623	2.5	1.334	1.778	.4217	.1778	7.5	2.371	5.623
.7413	.5495	2.6	1.349	1.820	.4169	.1738	7.6	2.399	5.754
.7328	.5370	2.7	1.365	1.862	.4121	.1698	7.7	2.427	5.888
.7244	.5248	2.8	1.380	1.905	.4074	.1660	7.8	2.455	6.026
.7161	.5129	2.9	1.396	1.950	.4027	.1622	7.9	2.483	6.166
.7079	.5012	3.0	1.413	1.995	.3981	.1585	8.0	2.512	6.310
.6998	.4898	3.1	1.429	2.042	.3936	.1549	8.1	2.541	6.457
.6918	.4786	3.2	1.445	2.089	.3890	.1514	8.2	2.570	6.607
.6839	.4677	3.3	1.462	2.138	.3846	.1479	8.3	2.600	6.761
.6761	.4571	3.4	1.479	2.188	.3802	.1445	8.4	2.630	6.918
.6683	.4467	3.5	1.496	2.239	.3758	.1413	8.5	2.661	7.079
.6607	.4365	3.6	1.514	2.291	.3715	.1380	8.6	2.692	7.244
.6531	.4266	3.7	1.531	2.344	.3673	.1349	8.7	2.723	7.413
.6457	.4169	3.8	1.549	2.399	.3631	.1318	8.8	2.754	7.586
.6383	.4074	3.9	1.567	2.455	.3589	.1288	8.9	2.786	7.762
.6310	.3981	4.0	1.585	2.512	.3548	.1259	9.0	2.818	7.943
.6237	.3890	4.1	1.603	2.570	.3508	.1230	9.1	2.851	8.128
.6166	.3802	4.2	1.622	2.630	.3467	.1202	9.2	2.884	8.318
.6095	.3715	4.3	1.641	2.692	.3428	.1175	9.3	2.917	8.511
.6026	.3631	4.4	1.660	2.754	.3388	.1148	9.4	2.951	8.710
.5957	.3548	4.5	1.679	2.818	.3350	.1122	9.5	2.985	8.913
.5888	.3467	4.6	1.698	2.884	.3311	.1096	9.6	3.020	9.120
.5821	.3388	4.7	1.718	2.951	.3273	.1072	9.7	3.055	9.333
.5754	.3311	4.8	1.738	3.020	.3236	.1047	9.8	3.090	9.550
.5689	.3236	4.9	1.758	3.090	.3199	.1023	9.9	3.126	9.772

Table I (continued)

← dB →					← dB →				
Voltage Ratio	Power Ratio	dB	Voltage Ratio	Power Ratio	Voltage Ratio	Power Ratio	dB	Voltage Ratio	Power Ratio
.3162	.1000	10.0	3.162	10.000	.1585	.02512	16.0	6.310	39.81
.3126	.09772	10.1	3.199	10.23	.1567	.02455	16.1	6.383	40.74
.3090	.09550	10.2	3.236	10.47	.1549	.02399	16.2	6.457	41.69
.3055	.09333	10.3	3.273	10.72	.1531	.02344	16.3	6.531	42.66
.3020	.09120	10.4	3.311	10.96	.1514	.02291	16.4	6.607	43.65
.2985	.08913	10.5	3.350	11.22	.1496	.02239	16.5	6.683	44.67
.2951	.08710	10.6	3.388	11.48	.1479	.02188	16.6	6.761	45.71
.2917	.08511	10.7	3.428	11.75	.1462	.02138	16.7	6.839	46.77
.2884	.08318	10.8	3.467	12.02	.1445	.02089	16.8	6.918	47.86
.2851	.08128	10.9	3.508	12.30	.1429	.02042	16.9	6.998	48.98
.2818	.07943	11.0	3.548	12.59	.1413	.01995	17.0	7.079	50.12
.2786	.07762	11.1	3.589	12.88	.1396	.01950	17.1	7.161	51.29
.2754	.07586	11.2	3.631	13.18	.1380	.01905	17.2	7.244	52.48
.2723	.07413	11.3	3.673	13.49	.1365	.01862	17.3	7.328	53.70
.2692	.07244	11.4	3.715	13.80	.1349	.01820	17.4	7.413	54.95
.2661	.07079	11.5	3.758	14.13	.1334	.01778	17.5	7.499	56.23
.2630	.06918	11.6	3.802	14.45	.1318	.01738	17.6	7.586	57.54
.2600	.06761	11.7	3.846	14.79	.1303	.01698	17.7	7.674	58.88
.2570	.06607	11.8	3.890	15.14	.1288	.01660	17.8	7.762	60.26
.2541	.06457	11.9	3.936	15.49	.1274	.01622	17.9	7.852	61.66
.2512	.06310	12.0	3.981	15.85	.1259	.01585	18.0	7.943	63.10
.2483	.06166	12.1	4.027	16.22	.1245	.01549	18.1	8.035	64.57
.2455	.06026	12.2	4.074	16.60	.1230	.01514	18.2	8.128	66.07
.2427	.05888	12.3	4.121	16.98	.1216	.01479	18.3	8.222	67.61
.2399	.05754	12.4	4.169	17.38	.1202	.01445	18.4	8.318	69.18
.2371	.05623	12.5	4.217	17.78	.1189	.01413	18.5	8.414	70.79
.2344	.05495	12.6	4.266	18.20	.1175	.01380	18.6	8.511	72.44
.2317	.05370	12.7	4.315	18.62	.1161	.01349	18.7	8.610	74.13
.2291	.05248	12.8	4.365	19.05	.1148	.01318	18.8	8.710	75.86
.2265	.05129	12.9	4.416	19.50	.1135	.01288	18.9	8.811	77.62
.2239	.05012	13.0	4.467	19.95	.1122	.01259	19.0	8.913	79.43
.2213	.04898	13.1	4.519	20.42	.1109	.01230	19.1	9.016	81.28
.2188	.04786	13.2	4.571	20.89	.1096	.01202	19.2	9.120	83.18
.2163	.04677	13.3	4.624	21.38	.1084	.01175	19.3	9.226	85.11
.2138	.04571	13.4	4.677	21.88	.1072	.01148	19.4	9.333	87.10
.2113	.04467	13.5	4.732	22.39	.1059	.01122	19.5	9.441	89.13
.2089	.04365	13.6	4.786	22.91	.1047	.01096	19.6	9.550	91.20
.2065	.04266	13.7	4.842	23.44	.1035	.01072	19.7	9.661	93.33
.2042	.04169	13.8	4.898	23.99	.1023	.01047	19.8	9.772	95.50
.2018	.04074	13.9	4.955	24.55	.1012	.01023	19.9	9.886	97.72
.1995	.03981	14.0	5.012	25.12	.1000	.01000	20.0	10.000	100.00
.1972	.03890	14.1	5.070	25.70					
.1950	.03802	14.2	5.129	26.30					
.1928	.03715	14.3	5.188	26.92					
.1905	.03631	14.4	5.248	27.54					
.1884	.03548	14.5	5.309	28.18					
.1862	.03467	14.6	5.370	28.84					
.1841	.03388	14.7	5.433	29.51					
.1820	.03311	14.8	5.495	30.20					
.1799	.03236	14.9	5.559	30.90					
.1778	.03162	15.0	5.623	31.62					
.1758	.03090	15.1	5.689	32.36					
.1738	.03020	15.2	5.754	33.11					
.1718	.02951	15.3	5.821	33.88					
.1698	.02884	15.4	5.888	34.67					
.1679	.02818	15.5	5.957	35.48					
.1660	.02754	15.6	6.026	36.31					
.1641	.02692	15.7	6.095	37.15					
.1622	.02630	15.8	6.166	38.02					
.1603	.02570	15.9	6.237	38.90					

← dB →				
Voltage Ratio	Power Ratio	dB	Voltage Ratio	Power Ratio
3.162×10^{-1}	10^{-1}	10	3.162	10
	10^{-2}	20		10^2
3.162×10^{-2}	10^{-3}	30	3.162×10	10^3
	10^{-4}	40		10^4
3.162×10^{-3}	10^{-5}	50	3.162×10^2	10^5
	10^{-6}	60		10^6
3.162×10^{-4}	10^{-7}	70	3.162×10^3	10^7
	10^{-8}	80		10^8
3.162×10^{-5}	10^{-9}	90	3.162×10^4	10^9
10^{-6}	10^{-10}	100	10^5	10^{10}

To find decibel values outside the range of this table, see introduction to these tables.

Table II

GIVEN: $\left\{ \begin{array}{l} \text{Voltage} \\ \text{Current} \end{array} \right\}$ Ratio

TO FIND: Decibels

POWER RATIOS

To find the number of decibels corresponding to a given power ratio — Assume the given power ratio to be a voltage ratio and find the corresponding number of decibels from the table. The desired result is exactly one-half of the number of decibels thus found.

Example— Given: a power ratio of 3.41.

Find: 3.41 in the table:

3.41 → 10.655 dB (voltage)

10.655 dB × ½ = 5.328 dB (power)

Voltage Ratio	.00	.01	.02	.03	.04	.05	.06	.07	.08	.09
1.0	.000	.086	.172	.257	.341	.424	.506	.588	.668	.749
1.1	.828	.906	.984	1.062	1.138	1.214	1.289	1.364	1.438	1.511
1.2	1.584	1.656	1.727	1.798	1.868	1.938	2.007	2.076	2.144	2.212
1.3	2.279	2.345	2.411	2.477	2.542	2.607	2.671	2.734	2.798	2.860
1.4	2.923	2.984	3.046	3.107	3.167	3.227	3.287	3.346	3.405	3.464
1.5	3.522	3.580	3.637	3.694	3.750	3.807	3.862	3.918	3.973	4.028
1.6	4.082	4.137	4.190	4.244	4.297	4.350	4.402	4.454	4.506	4.558
1.7	4.609	4.660	4.711	4.761	4.811	4.861	4.910	4.959	5.008	5.057
1.8	5.105	5.154	5.201	5.249	5.296	5.343	5.390	5.437	5.483	5.529
1.9	5.575	5.621	5.666	5.711	5.756	5.801	5.845	5.889	5.933	5.977
2.0	6.021	6.064	6.107	6.150	6.193	6.235	6.277	6.319	6.361	6.403
2.1	6.444	6.486	6.527	6.568	6.608	6.649	6.689	6.729	6.769	6.809
2.2	6.848	6.888	6.927	6.966	7.008	7.044	7.082	7.121	7.159	7.197
2.3	7.235	7.272	7.310	7.347	7.384	7.421	7.458	7.495	7.532	7.568
2.4	7.604	7.640	7.676	7.712	7.748	7.783	7.819	7.854	7.889	7.924
2.5	7.959	7.993	8.028	8.062	8.097	8.131	8.165	8.199	8.232	8.266
2.6	8.299	8.333	8.366	8.399	8.432	8.465	8.498	8.530	8.563	8.595
2.7	8.627	8.659	8.691	8.723	8.755	8.787	8.818	8.850	8.881	8.912
2.8	8.943	8.974	9.005	9.036	9.066	9.097	9.127	9.158	9.188	9.218
2.9	9.248	9.278	9.308	9.337	9.367	9.396	9.426	9.455	9.484	9.513
3.0	9.542	9.571	9.600	9.629	9.657	9.686	9.714	9.743	9.771	9.799
3.1	9.827	9.855	9.883	9.911	9.939	9.966	9.994	10.021	10.049	10.076
3.2	10.103	10.130	10.157	10.184	10.211	10.238	10.264	10.291	10.317	10.344
3.3	10.370	10.397	10.423	10.449	10.475	10.501	10.527	10.553	10.578	10.604
3.4	10.630	10.655	10.681	10.706	10.731	10.756	10.782	10.807	10.832	10.857
3.5	10.881	10.906	10.931	10.955	10.980	11.005	11.029	11.053	11.078	11.102
3.6	11.126	11.150	11.174	11.198	11.222	11.246	11.270	11.293	11.317	11.341
3.7	11.364	11.387	11.411	11.434	11.457	11.481	11.504	11.527	11.550	11.573
3.8	11.596	11.618	11.641	11.664	11.687	11.709	11.732	11.754	11.777	11.799
3.9	11.821	11.844	11.866	11.888	11.910	11.932	11.954	11.976	11.998	12.019
4.0	12.041	12.063	12.085	12.106	12.128	12.149	12.171	12.192	12.213	12.234
4.1	12.256	12.277	12.298	12.319	12.340	12.361	12.382	12.403	12.424	12.444
4.2	12.465	12.486	12.506	12.527	12.547	12.568	12.588	12.609	12.629	12.649
4.3	12.669	12.690	12.710	12.730	12.750	12.770	12.790	12.810	12.829	12.849
4.4	12.869	12.889	12.908	12.928	12.948	12.967	12.987	13.006	13.026	13.045
4.5	13.064	13.084	13.103	13.122	13.141	13.160	13.179	13.198	13.217	13.236
4.6	13.255	13.274	13.293	13.312	13.330	13.349	13.368	13.386	13.405	13.423
4.7	13.442	13.460	13.479	13.497	13.516	13.534	13.552	13.570	13.589	13.607
4.8	13.625	13.643	13.661	13.679	13.697	13.715	13.733	13.751	13.768	13.786
4.9	13.804	13.822	13.839	13.857	13.875	13.892	13.910	13.927	13.945	13.962
5.0	13.979	13.997	14.014	14.031	14.049	14.066	14.083	14.100	14.117	14.134
5.1	14.151	14.168	14.185	14.202	14.219	14.236	14.253	14.270	14.287	14.303
5.2	14.320	14.337	14.353	14.370	14.387	14.403	14.420	14.436	14.453	14.469
5.3	14.486	14.502	14.518	14.535	14.551	14.567	14.583	14.599	14.616	14.632
5.4	14.648	14.664	14.680	14.696	14.712	14.728	14.744	14.760	14.776	14.791
5.5	14.807	14.823	14.839	14.855	14.870	14.886	14.902	14.917	14.933	14.948
5.6	14.964	14.979	14.995	15.010	15.026	15.041	15.056	15.072	15.087	15.102
5.7	15.117	15.133	15.148	15.163	15.178	15.193	15.208	15.224	15.239	15.254
5.8	15.269	15.284	15.298	15.313	15.328	15.343	15.358	15.373	15.388	15.402
5.9	15.417	15.432	15.446	15.461	15.476	15.490	15.505	15.519	15.534	15.549

Table II (continued)

Voltage Ratio	.00	.01	.02	.03	.04	.05	.06	.07	.08	.09
6.0	15.563	15.577	15.592	15.606	15.621	15.635	15.649	15.664	15.678	15.692
6.1	15.707	15.721	15.735	15.749	15.763	15.778	15.792	15.806	15.820	15.834
6.2	15.848	15.862	15.876	15.890	15.904	15.918	15.931	15.945	15.959	15.973
6.3	15.987	16.001	16.014	16.028	16.042	16.055	16.069	16.083	16.096	16.110
6.4	16.124	16.137	16.151	16.164	16.178	16.191	16.205	16.218	16.232	16.245
6.5	16.258	16.272	16.285	16.298	16.312	16.325	16.338	16.351	16.365	16.378
6.6	16.391	16.404	16.417	16.430	16.443	16.456	16.469	16.483	16.496	16.509
6.7	16.521	16.534	16.547	16.560	16.573	16.586	16.599	16.612	16.625	16.637
6.8	16.650	16.663	16.676	16.688	16.701	16.714	16.726	16.739	16.752	16.764
6.9	16.777	16.790	16.802	16.815	16.827	16.840	16.852	16.865	16.877	16.890
7.0	16.902	16.914	16.927	16.939	16.951	16.964	16.976	16.988	17.001	17.013
7.1	17.025	17.037	17.050	17.062	17.074	17.086	17.098	17.110	17.122	17.135
7.2	17.147	17.159	17.171	17.183	17.195	17.207	17.219	17.231	17.243	17.255
7.3	17.266	17.278	17.290	17.302	17.314	17.326	17.338	17.349	17.361	17.373
7.4	17.385	17.396	17.408	17.420	17.431	17.443	17.455	17.466	17.478	17.490
7.5	17.501	17.513	17.524	17.536	17.547	17.559	17.570	17.582	17.593	17.605
7.6	17.616	17.628	17.639	17.650	17.662	17.673	17.685	17.696	17.707	17.719
7.7	17.730	17.741	17.752	17.764	17.775	17.786	17.797	17.808	17.820	17.831
7.8	17.842	17.853	17.864	17.875	17.886	17.897	17.908	17.919	17.931	17.942
7.9	17.953	17.964	17.975	17.985	17.996	18.007	18.018	18.029	18.040	18.051
8.0	18.062	18.073	18.083	18.094	18.105	18.116	18.127	18.137	18.148	18.159
8.1	18.170	18.180	18.191	18.202	18.212	18.223	18.234	18.244	18.255	18.266
8.2	18.276	18.287	18.297	18.308	18.319	18.329	18.340	18.350	18.361	18.371
8.3	18.382	18.392	18.402	18.413	18.423	18.434	18.444	18.455	18.465	18.475
8.4	18.486	18.496	18.506	18.517	18.527	18.537	18.547	18.558	18.568	18.578
8.5	18.588	18.599	18.609	18.619	18.629	18.639	18.649	18.660	18.670	18.680
8.6	18.690	18.700	18.710	18.720	18.730	18.740	18.750	18.760	18.770	18.780
8.7	18.790	18.800	18.810	18.820	18.830	18.840	18.850	18.860	18.870	18.880
8.8	18.890	18.900	18.909	18.919	18.929	18.939	18.949	18.958	18.968	18.978
8.9	18.988	18.998	19.007	19.017	19.027	19.036	19.046	19.056	19.066	19.075
9.0	19.085	19.094	19.104	19.114	19.123	19.133	19.143	19.152	19.162	19.171
9.1	19.181	19.190	19.200	19.209	19.219	19.228	19.238	19.247	19.257	19.266
9.2	19.276	19.285	19.295	19.304	19.313	19.323	19.332	19.342	19.351	19.360
9.3	19.370	19.379	19.388	19.398	19.407	19.416	19.426	19.435	19.444	19.453
9.4	19.463	19.472	19.481	19.490	19.499	19.509	19.518	19.527	19.536	19.545
9.5	19.554	19.564	19.573	19.582	19.591	19.600	19.609	19.618	19.627	19.636
9.6	19.645	19.654	19.664	19.673	19.682	19.691	19.700	19.709	19.718	19.726
9.7	19.735	19.744	19.753	19.762	19.771	19.780	19.789	19.798	19.807	19.816
9.8	19.825	19.833	19.842	19.851	19.860	19.869	19.878	19.886	19.895	19.904
9.9	19.913	19.921	19.930	19.939	19.948	19.956	19.965	19.974	19.983	19.991

Voltage Ratio	0	1	2	3	4	5	6	7	8	9
10	20.000	20.828	21.584	22.279	22.923	23.522	24.082	24.609	25.105	25.575
20	26.021	26.444	26.848	27.235	27.604	27.959	28.299	28.627	28.943	29.248
30	29.542	29.827	30.103	30.370	30.630	30.881	31.126	31.364	31.596	31.821
40	32.041	32.256	32.465	32.669	32.869	33.064	33.255	33.442	33.625	33.804
50	33.979	34.151	34.320	34.486	34.648	34.807	34.964	35.117	35.269	35.417
60	35.563	35.707	35.848	35.987	36.124	36.258	36.391	36.521	36.650	36.777
70	36.902	37.025	37.147	37.266	37.385	37.501	37.616	37.730	37.842	37.953
80	38.062	38.170	38.276	38.382	38.486	38.588	38.690	38.790	38.890	38.988
90	39.085	39.181	39.276	39.370	39.463	39.554	39.645	39.735	39.825	39.913
100	40.000	—	—	—	—	—	—	—	—	—

To find decibel values outside the range of this table, see introduction to these tables.

Federal Stock Numbers of General Radio Products

Catalog Number	Federal Stock Number	Agency	Catalog Number	Federal Stock Number	Agency	Catalog Number	Federal Stock Number	Agency
0274-9730	5935-543-8325	AF	0874-9700	5985-671-8325	DESC	0938-9791	5940-258-4719	
0274-9731	5935-543-8323	AF	0874-9701	5935-961-5498		0938-9791	5940-642-4355	
0274-9735	5935-505-4976		0874-9702	5985-707-2830	DESC	0938-9792	5970-237-5691	DSA
0274-9736	5935-192-4620	AF	0874-9704	6625-705-6269	AF	0938-9793	5935-258-4738	
0274-9736	5935-258-6298		0874-9706	5935-053-0040		0938-9796	5940-522-3622	
0274-9737	5935-224-5982	DESC	0874-9710	5935-087-5374		0940-9705	6625-842-4869	AF
0274-9746	5935-549-2118	DESC	0874-9710	5935-833-7247	N	0940-9706	6625-842-4871	AF
0274-9746	5935-665-4394	DESC	0874-9711	5935-905-5335		0940-9707	6625-842-4868	AF
0274-9747	5935-754-5770	AF	0874-9716	5935-758-9529		0940-9708	6625-842-4872	AF
0274-9748	5995-557-0848		0874-9717	5935-904-8557	DESC	0971-9702	5905-681-5653	
0274-9748	5995-642-9560	DSA	0874-9718	5935-502-8354		0971-9706	5905-762-2548	
0274-9750	6625-557-8454	AF	0874-9791	5935-420-3645		0971-9708	5905-762-2547	
0274-9751	5935-872-8525	DESC	0874-9800	5935-984-5563	DESC	0971-9710	5905-557-1569	
0480-9986	5975-953-8144	ARMY	0874-9802	5935-706-2827		0971-9711	5905-583-2759	
0510-9511	5930-499-1999	DESC	0874-9804	5935-921-8789		0971-9712	5905-927-7538	
0510-9604	5930-499-2000	DESC	0874-9810	5935-225-8768	DESC	0971-9713	5905-887-7672	
0510-9701	6625-553-8082	AF	0874-9810	5935-679-2492	AF	0971-9714	5905-581-1724	
0510-9702	6625-311-6104	AF	0874-9816	5935-761-0408	DESC	0971-9716	5905-881-8062	
0510-9703	6625-993-1190	AF, N	0874-9818	5935-666-4873		0973-9704	5905-052-1927	
0510-9704	6625-864-6074	AF, N	0874-9820	5935-887-6008		0973-9705	5905-089-5434	
0510-9704	5910-560-6248	DESC	0874-9831	5935-916-0791		0973-9707	5905-660-3747	AF
0510-9705	5905-561-4150	DESC	0874-9832	5935-789-6031	DESC	0973-9708	5905-827-1899	
0510-9705	6625-709-0308	AF	0874-9833	5935-981-7264	AF	0973-9710	5905-690-5684	AF, DESC
0510-9705	6625-989-8428	N	0874-9834	5935-914-8878		0973-9712	5905-655-1325	
0510-9706	5905-561-4158	DESC	0874-9839	5935-840-7284	DESC	0973-9714	5905-583-5254	
0510-9706	6625-709-0310	AF	0874-9841	5935-965-6178	AF	0973-9716	5905-406-9897	DESC
0510-9707	6625-708-7235	AF, N	0874-9843	5935-944-3687	DESC	0973-9717	5905-074-8719	
0510-9708	5905-561-4160	DESC	0874-9849	5935-925-6261		0975-9710	5905-681-3390	
0510-9806	6625-690-5156	AF	0874-9853	5935-925-6262	DESC	0975-9712	5905-683-2340	NASA
0631-9601	5960-193-5124		0874-9863	6145-020-8773		0975-9713	5905-556-6565	
0716-9803	6625-649-2961	AF	0874-9864	5935-555-1885	DESC	0975-9716	5905-725-0725	AF
0874-9511	5985-912-1544		0874-9864	5975-104-6840	DESC	0975-9717	5905-806-3715	AF, DESC
0874-9513	6625-623-0067		0874-9910	5935-864-9958		0975-9718	5905-617-2109	AF
0874-9526	5935-627-0622	AF	0874-9940	6625-793-1352	AF	1001-9701	6625-866-0168	
0874-9527	5935-933-8153		0874-9942	5985-778-2146		1003-9701	6625-867-0787	
0874-9537	5915-786-9168	DESC	0874-9944	6625-624-7149	AF	1162-9597	6625-333-9860	AF
0874-9541	5915-937-5404		0874-9945	6625-623-0328	N	1191-9711	6625-926-7641	ARMY
0874-9545	5915-907-8721		0874-9954	5985-992-2109	DESC	1201-9703	4920-925-7490	N
0874-9564	5985-525-3010	DESC	0874-9955	5985-494-4745	DESC	1201-9703	6625-902-9745	
0874-9568	5905-812-9250		0874-9970	5985-083-4708		1203-9702	6625-777-6438	NASA
0874-9570	5905-755-2378	DESC	0874-9972	6625-706-2829		1203-9702	1440-062-4760	N
0874-9570	6625-826-0570		0874-9980	5985-888-4296	DESC	1210-9703	4920-925-7490	N
0874-9571	5985-087-4715	DESC	0874-9982	5985-707-2931		1211-9703	4931-777-1384	AF
0874-9572	5985-080-2122	DESC	0874-9990	5935-669-5817		1215-9703	6625-965-8235	
0874-9572	6625-739-1200	AF	0874-9003	6625-932-8155	AF	1217-9703	6625-903-5469	AF
0874-9577	5950-752-3144	DESC	0900-9405	5935-000-0202		1232-9701	6625-873-6684	AF
0874-9577	5950-921-6008	AF	0900-9651	6625-498-0925		1232-9701	4931-916-8256	DSA
0874-9577	6625-921-6305	N	0900-9711	5935-838-2722	AF	1263-9703	6625-061-0214	AF
0874-9577	5985-823-4709	ASO, DESC	0900-9791	5935-466-1172	DESC	1264-9601	5995-087-4832	DSA
0874-9596	6625-887-7753	AF	0900-9811	5935-838-2723	AF	1269-9701	6625-871-8018	AF
0874-9604	6625-713-2108	AF	0900-9883	4931-228-1319	DSA	1304-9802	6625-585-9736	AF
0874-9608	6625-713-2109	AF	0900-9971	5985-083-4708		1304-9812	4931-778-0582	
0874-9612	6625-715-5578	AF	0938-9758	5935-295-5407		1309-9701	6625-107-8260	AF
0874-9621	5985-911-0540	DESC	0938-9760	5940-562-3507		1310-9701	6625-054-3476	DESC
0874-9645	4920-922-6219	N	0938-9764	5940-235-7993	DSA	1311-9701	6625-930-3449	DSA
0874-9660	6625-059-7768		0938-9765	5935-815-8783		1330-9701	6625-553-0969	AF
0874-9666	6625-020-9712	AF	0938-9765	5940-877-8166		1362-9701	6625-489-3711	AF
0874-9680	6625-789-4723		0938-9766	5940-223-1434		1390-9702	6625-799-8999	AF
0874-9680	5995-836-3152	AF	0938-9766	5940-250-5577		1401-9702	6625-585-3992	AF
0874-9682	5995-754-8178	N	0938-9766	5940-544-8121	M.C.	1401-9703	6625-585-3989	AF
0874-9683	5995-933-6852	DSA	0938-9767	5940-500-8717		1403-9701	6625-730-8565	AF
0874-9683	5995-935-2561	DSA	0938-9767	5940-666-3892		1403-9704	6625-804-7402	AF
0874-9690	6625-793-1351	AF	0938-9768	5940-549-9037		1403-9707	6625-804-7401	AF
0874-9692	6625-729-4629	AF	0938-9768	5940-643-6231		1403-9711	6625-804-9059	AF
0874-9700	5935-765-5481	DESC	0938-9771	5940-549-6743		1403-9714	6625-804-9053	AF
0874-9700	5935-855-3770	DESC	0938-9776	5970-628-7701		1404-9701	4931-916-5949	

Catalog Number	Federal Stock Number	Agency	Catalog Number	Federal Stock Number	Agency	Catalog Number	Federal Stock Number	Agency
1409-9706	6625-629-1983	AF	1557-9701	6625-879-5114			5950-224-7874	AF
1409-9707	6625-804-9058		1560-9605	5965-971-5635		3040-5111	5950-835-4462	AF, DESC
1409-9711	6625-585-4052	AF	1560-9652	6625-982-9461	A	3040-5118	5950-681-7431	AF, DESC
1409-9712	6625-585-4053	AF	1560-9695	6625-459-7539	AF	3050-5110	6120-845-1176	AF
1409-9713	6625-583-0038	AF	1560-9696	6625-982-9460	A	3050-5111	6120-242-4865	DSA
1409-9718	6625-557-0876	AF	1560-9921	6625-086-9982		3050-5130	5820-756-5566	
1409-9720	6625-585-4051	AF	1562-9701	6625-401-5364	AF	3058-5110	6120-105-6108	AF, DESC
1409-9721	6625-585-4050	AF	1564-9701	6625-883-8858	N	3060-5012	6120-054-7794	AF
1409-9724	6625-653-1565	AF	1564-9771	6625-484-5970	N	3060-5110	6120-849-2588	AF
1409-9725	6625-629-1980	AF	1565-9701	6625-912-6149	AF	3060-5110	5950-948-6988	DESC
1419-9701	6625-953-7537	AF	1565-9901	6515-236-1204	AF	3060-5111	6120-816-1517	AF
1419-9702	6625-679-0402		1568-9701	6625-454-0720	AF	3060-5118	6120-772-7917	AF
1419-9711	6625-585-1670	AF	1571-9831	6110-087-4771	DSA	3060-5119	6120-682-2557	DESC
1422-9704	6625-987-9060	AF	1571-9898	6110-897-9800	AF	3060-5119	5950-682-2557	AF
1422-9809	6625-846-4429		1602-9702	6625-511-0512	AF	3060-5130	6120-805-0745	DESC
1422-9823	6625-779-3602	A	1606-9702	6625-432-5414	N	3070-5110	6120-660-9211	AF
1422-9855	6625-060-1818	AF	1606-9702	combined with		3070-5111	6120-828-1490	AF
1422-9916	6625-891-5939	AF	1606-9602	6625-103-2040	AF	3070-5118	5950-686-2153	
1423-9801	6625-775-1753	AF	1608-9811	6625-902-8687	AF	3070-5119	6625-073-2226	N
1424-9701	6625-731-7404	AF	1609-9701	6625-106-0643	AF	3090-5110	6120-800-2482	AF
1433-9700	6625-892-4783	N	1620-9701	4931-916-5952		3090-5111	6120-834-2923	AF
1433-9702	6625-437-9157	AF	1632-9801	6625-223-4811	AF	3090-5119	6120-833-0904	DSA
1433-9702	6625-649-4037	N	1632-9801	6625-476-0593	AF	3090-5130	6120-669-8565	AF
1433-9712	6625-649-0034	N	1632-9811	6625-777-4118		3090-5230	5950-068-5180	AF, DESC
1433-9716	6625-228-9918	N	1633-9801	6625-442-3549	ARMY	3100-5012	5950-926-0742	DESC
1433-9718	6625-123-7459	N	1644-9701	6625-867-6628	N	3100-5110	6120-710-5747	AF
1433-9722	6625-947-7534	AF	1650-9702	6625-435-5470	AF	3100-5110	6120-103-4982	N
1433-9731	6625-480-0950	N	1790-9705	6625-243-7461	AF	3100-5111	6120-877-7923	AF, DESC
1440-9601	6625-133-7548	A	1806-9701	6625-832-8956		3120-5110	5950-078-1445	
1450-9891	6625-201-8779		1840-9701	6625-937-6156	AF	3130-5111	6120-849-8928	AF
1450-9891	5985-201-8779	N, DESC						
1450-9893	6625-612-1837	AF				3150-5110	6120-681-6862	AF
1455-9700	6625-123-7458	AF	1863-9700	6625-456-7442	FAA	3150-5111	6120-769-1140	DESC
1455-9702	6625-722-1569	AF	1863-9700	6625-583-0386	N	3150-5120	6120-911-9777	
1482-9702	6625-583-0040	AF	2990-9201	4931-178-1108	ARMY	3160-5121	6120-927-7826	
1482-9703	6625-804-4125	AF	2990-9159	6625-411-4538	AF	3160-5130	6120-811-0505	DESC
1482-9704	6625-806-8627		3010-5110	5950-606-8682	DESC	3200-5900	5977-400-7985	DSA
1482-9705	6625-567-2700	AF	3010-5110	5950-581-5189	AF	3200-5901	5977-536-3287	
1482-9706	6625-580-1501	AF	3010-5110	5950-519-7859	DESC	3200-5906	5977-775-6799	
1482-9707	6625-580-1502	AF	*	5950-807-0947	DESC	3200-5908	5977-727-9061	
1482-9708	6625-583-0041	AF	3010-5111	5950-683-3641	DESC	3200-5910	5977-880-1553	
1482-9710	6625-993-9456	AF	3010-5120	5950-082-8153		3200-5911	5977-033-8550	
1482-9711	6625-556-8585	AF	3010-5130	6120-837-7133	AF	3200-5912	5977-877-6844	
1482-9712	6625-556-8584	AF	*	5950-556-1724	AF	3200-5913	5977-841-5878	
1482-9713	6625-804-4129	AF	*	5950-985-3990	DESC	3200-5923	5977-433-2716	DSA
1482-9714	6625-804-4130		3030-5012	5950-987-5601	DESC	3410-5110	5950-121-5326	DESC
1482-9716	6625-583-0044	AF	3030-5013	4931-777-1385		3410-5110	5950-519-7789	DESC
1482-9717	6625-993-9458		3030-5015	5950-112-3440	DESC	3410-5110	5950-538-5662	AF
1482-9718	6625-993-9459	AF	3030-5110	5950-053-9971	DESC	3410-5110	5950-617-9474	ARMY
1482-9720	6625-583-0043	AF	3030-5110	5950-631-1424	DESC	3410-5120	5950-557-6989	AF
1491-9714	6625-808-9523	AF, N	3030-5110	5950-951-9647	DESC	3410-5130	5950-557-6988	DESC
1521-9428	6625-864-0631	N	3030-5110	5950-754-5940	AF, DESC	3410-5130	5950-877-4863	DESC
1521-9447	6625-450-7622	AF	3030-5110	5950-578-5592	AF	3430-5110	5950-504-9090	AF, DESC
1521-9463	6625-862-0632		*	5950-443-1794	DESC	3430-5110	5950-615-0209	DESC
1521-9601	5905-448-5331		3030-5111	5950-553-6657	AF	3430-5120	5950-103-7005	DESC
1521-9602	5905-448-5335		*	5950-020-6790	AF, DESC	3430-5130	5950-99-1261	DESC
1521-9603	5905-448-5334		3030-5118	5950-688-5722	AF, DESC	3460-5110	6120-480-5581	N
1521-9841	6625-484-5972	N	3030-5118	5950-446-5004	AF, DESC	3460-5110	5950-689-4807	DESC
1525-9701	6625-411-9633	AF	3030-5118	5950-823-1051	DESC	3460-5110	6120-812-7681	AF
1531-9430	6680-880-1844	N	3030-5119	5950-617-9242	DESC	3460-5110	6120-826-6238	AF
1531-9601	5960-844-5968	DESC	3030-5120	6120-884-1441	AF	3460-5120	5950-755-9349	
1538-9601	5960-781-1466	DESC	3030-5130	6120-681-6930	AF	3460-5130	5950-504-9047	AF
1538-9601	6240-422-1278	ARMY	*	5950-683-3206		3460-5130	6120-504-9047	DSA
1551-9703	6625-969-4136	DSA	3030-5131	6120-879-3698	AF	3490-5110	6120-824-7393	AF
1551-9703	combined with							
1262-9702	4931-891-3070	ARMY	3038-5110	5950-110-0379	DESC	3490-5110	6120-052-3305	DSA
1553-9701	6625-103-3117	AF	3038-5130	6120-357-7520	DSA	3490-5130	6120-725-4226	AF
1553-9701	6625-977-5779	N	3040-5110	5950-809-5379	DESC			
1556-9702	6625-994-9424	AF						

* Like preceding entry with additional moisture and fungus proofing.

Index by Subject and Title

A

Abbreviations	344
Accelerometer	100
Acoustic Recorder	47, 49, 52
Acoustic Systems	22
Adaptor, 50- Ω coax, GR874	240
50- Ω coax, GR900	261
75- Ω coax, GR874	252
75 to 50 Ω , GR900	266
75- Ω coax, GR900	266
Audio/Acoustic	98
Flange, GR900	260
Low-Frequency	355
Microphone	98
Rack Panel	338
Adjustable Autotransformers	293
Admittance Meter, UHF	210
Air Capacitor, Standard	178
Air Line, Fixed, 50- Ω coax, GR874	247
50- Ω coax, GR900	265
75- Ω coax, GR874	254
Adjustable, 50- Ω coax, GR874	247
Tube and Rod, 50-, 75- Ω , GR874	256
Tube and Rod, 50- Ω , GR900	268
Amplifier, 30-MHz I-F	215
Level Regulating	89
Multichannel, Audio	88
Power, Audio	76
Programmable	88
Scanning, Multichannel	88
Tuned	162
Analog Limit Comparator	149
Analog Tester, Multistation	108
Analyzer, 1/3 and 1/10 Octave	57
Fast-Fourier	70
Impact-Noise	27
Impulse-Noise, Precision	45
Logic-Circuit	110, 112, 115
Motion, Stroboscopic	269
Narrow Band	58, 60
Octave-Band	45
Real-Time	64, 70
RF Network	202
Signal	56
Sound and Vibration	57
Sound and Vibration, Recording	62
Sound-Level, Precision	45
Spectrum	58, 60
Third-Octave-Band, Stepped	52
Time-Series	70

Analyzer (cont'd)

Wave	58, 60
Wave, Recording	62, 63
Anodize Trimmer	
Systems	122, 123, 124
Attenuation Analyzer, RF	202
Attenuator, 50- Ω coax, GR874	245
50- Ω coax, GR900	264
75- Ω coax, GR874	254
Audio	92
Decade	322
Level Regulating	89
Low-Frequency	92, 246, 322, 323
Programmable Decade	246
Audio Amplifier, Multichannel	88
Audiometer Calibration Set	37
Audiometer, Recording	35
Audiometric Examination Rooms	34
Audiometry and Psychoacoustics	102
Audio Microvolter	92
Oscillator	77, 78, 79
Oscillator and Power Amplifier	76
Output Power Meter	90
Automatic Capacitance Bridge, 1-MHz	142
Component Test Systems	129, 136
Level Regulator	89
Line-Voltage Regulators	285
RLC bridge	138
Test and Measurement Systems	106
Autotransformers, Adjustable	293

B

Balun	243
Banana Plugs	334
Behavioral Research Instruments	103
Bias Insertion Unit, 50- Ω coax, GR874	250
Bias Supply	146
Binding Posts	332
Booth, Audiometric	34
Box, Capacitance	167-171
Inductance	198
Resistance	184-188
Bridge, 1-MHz Capacitance, Automatic	142
Bias Supply	146
Capacitance	161, 164
Capacitance, Precision	157
Conductance	181
Detector, Phase	159
Impedance, Manual	150, 152, 154

Bridge (cont'd)

Incremental-Inductance	195
Inductance	193, 195
Kelvin	181
Megohm	181, 182
Oscillator	158, 318
Oscillator/Detector	163
Portable	150, 154, 181
Precision	152, 156, 160, 181, 192
Resistance, DC	181
Resistance Limit	180
RF	211
RF, 50-, 75- Ω coax, GR874	256
RF Network Analyzer	202
RLC, Automatic	138
RLC, Manual	150, 152, 154
Wheatstone	181, 182
Brushes, Replacement, Variac	312
Burst Generator	321
Burst Generator, Strobe	281

C

Cabinets, Instrument	339
Cable, 50- Ω coax, GR874	251
Connectors, 50- Ω coax, GR874	239
Connectors, 50- Ω coax, GR900	260
Connectors, 75- Ω coax, GR874	252
Measurement Analyzer, RF	202
Microphone	98
Test System	132
Calibrator, AC/DC Voltage	92
Sound-Level	38
Audiometer	37
Vibration	101
Capacitance Bridge	161, 164
Bridge, Automatic	138
Bridge, Automatic, 1-MHz	142
Bridge, Manual	150, 152, 154
Bridge, Precision	157
Comparator	147
Measuring Assembly	160
Measuring System, Precision	156
Meter, Digital	140
Standards, Coaxial	176, 177, 178
Capacitor, Coupling, 50- Ω coax, GR874	250
Decade	167-171
Decade, Precision	167, 168
Leakage Test System	130
Standard, Air	178

Capacitor (Cont'd)			
Standard, Fixed	174, 175		
Standard, Mica	179		
Variable, coax, GR874	245		
Variable Precision	172		
Card-Punch Coupler	145		
Case, Storage, GR900	268		
Cassette Data Recorder	47		
Centering Ring, Rotatable, GR900	260		
Ceramic Microphones	94		
Chart Paper	51, 55, 87		
Chart Paper, Audiometer	35		
Choke, Paralleling, Variac	312		
Circuit/Component Tester, Multistation	108		
Circuit Tester, Digital	110, 112, 115		
Circuit Tester, Linear	126		
Cleaning Kit, GR900	268		
Coaxial Adaptor, 50- Ω , GR874	240		
Adaptor, 50- Ω , GR900	261		
Adaptor, 75- Ω , GR874	252		
Adaptor, 75- Ω , GR900	266		
Adaptor Flange, GR900	260		
Air Lines, 50- Ω , GR874	247		
Air Lines, 50- Ω , GR900	265		
Air Line, 75- Ω , GR874	254		
Air-Line Tube and Rod, 50-, 75- Ω , GR874	256		
Air-Line Rod and Tube, 50- Ω , GR900	268		
Attenuators, 50- Ω , GR874	245		
Attenuators, 50- Ω , GR900	264		
Attenuators, 75- Ω , GR874	254		
Bias Insertion Unit, 50- Ω , GR874	250		
Cable, 50- Ω , GR874	251		
Cable Connectors, 50- Ω , GR900	260		
Capacitance Standards	176, 177, 178		
Centering Ring, Rotatable, GR900	260		
Cleaning Kit, GR900	268		
Components, GR874	237		
Components, GR900	257		
Components, 75- Ω , GR874	252		
Components, 75- Ω , GR900	266		
Component Mount, 50- Ω , GR874	250		
Connector, 50- Ω , GR874	238		
Connector, 50- Ω , coax, GR900	259		
Connector, 75- Ω , GR874	252		
Connector, 75- Ω , GR900	266		
Connector Kits, 50- Ω , GR900	259		
Coaxial (cont'd)			
Coupling Capacitor, 50- Ω , GR874	250		
Coupling Probe, 50- Ω , GR874	250		
Crimping Tools, GR874	255		
Ell, 50- Ω , GR874	248		
Ell, 75- Ω , GR900	268		
Hardware Stand, GR874	255		
Insertion Unit, 50- Ω , GR874	250		
Lines, Slotted	212, 213		
Low-Pass Filters, 50- Ω , GR874	249		
Matching Pad, 75 to 50 Ω , GR874	253		
Matching Pad, 50 to 75 Ω , GR900	267		
Mixer, 50- Ω , GR874	248		
Panel Mounting Kit, GR900	260		
Patch Cords, 50-, 72-, 75- Ω , GR874	251		
Power Dividers, 50- Ω , GR874	248		
Rectifier/Detector, 50- Ω , GR874	249		
Resistance Standards	191		
RF Bridges, 50-, 75- Ω , GR874	256		
Rotary Joint, 50- Ω , GR874	248		
Series Inductor, 50- Ω , GR874	250		
Storage Case, GR900	268		
Tee, 50- Ω , GR874	248		
Termination, 50- Ω , GR874	244		
Termination, 50- Ω , GR900	263		
Termination, 75- Ω , GR874	254		
Termination, 75- Ω , GR900	267		
Tool Kit, GR900	268		
Tuner, 50- Ω , GR900	264		
Comparator, Analog Limit	149		
Digital Limit	144		
Impedance	147		
Resistance	180		
Component and Network Testing	105		
Component/Circuit Tester, Multistation	108		
Component Mount, 50- Ω coax, GR874	250		
Components, 50- Ω coax, GR874	237		
75- Ω coax, GR874	252		
50- Ω coax, GR900	257		
75- Ω coax, GR900	266		
Component Sorting Systems	129, 147		
Component Testing Systems	129, 136		
Computer-aided N/C Fabrication	118		
ComputerWrap™ Wire-Wrapping Systems	116		
Condenser Microphones	93		
Condenser Microphone Systems	99		
Connector Kits, 50- Ω coax, GR900	259		
Connectors, 50- Ω coax, GR874	238		
50- Ω coax, GR900	259		
75- Ω coax, GR874	252		
75- Ω coax, GR900	266		
Binding Post	332		
Jacks and Plugs	334		
Controllers, Line Voltage	269, 293		
Controls, Volume, Pots	337		
Counter, Frequency	326, 328		
Coupler, Card-Punch	145		
Coupler, Directional, Precision	217		
Coupler, Earphone	37		
Coupling Capacitor, 50- Ω coax, GR874	250		
Coupling Probe, 50- Ω coax, GR874	250		
Crimping Tools, GR874	255		
D			
Data Recorder, Audio	47		
DC Power Supply, Adjustable	196		
DC Recorder	86		
Decade Attenuator	322		
Attenuator, Programmable	246		
Capacitors	167-171		
Capacitor, Precision	167, 168		
Inductors	198, 199		
Oscillator	80		
Resistors	184-188		
Resistor, Programmable	184		
Voltage Divider	323		
Decibel Conversion Tables	345		
Delay Analyzer, RF	202		
Delay Generator, Strobe Flash	283		
Detector, 50- Ω coax, GR874	249		
Bridge	159		
Digital, RMS	69		
Heterodyne	214		
I-F Amplifier	215		
Null	162		
Oscillator, Bridge	163		
Phase	159		
RMS, Multichannel	69		
Dielectric Sample Holder	166		
Digital Detector, RMS, Multichannel	69		
Impedance Bridge	138		
Impedance Meter	140		
Limit Comparators	144		
Logic Testers	110, 112, 115		
Printer	145		
Tester, Multistation	108		

Digital (cont'd)	
Time-Series Analyzers	70
Vibration Control System	72
Dimension and Weight Definitions	341
Directional Coupler, Precision	217
Display Unit, Storage	66
Divider, Power, 50- Ω coax, GR874	248
Decade Voltage	323
Frequency	325
Dosimeter, Noise	30

E

Earphone Couplers	37
Electret-Condenser Microphones	93
Electrolytic Capacitance Bridge	164
Electronic Stroboscopes	269
Ell, 50- Ω coax, GR874	248
75- Ω coax, GR900	268

F

Fast-Fourier Analyzers	70
Federal Stock Numbers	350
Filter, Analyzing	67
Low-Pass, 50- Ω coax, GR874	249
Octave-Band	67
Parallel-Band	67
Pink-Noise	85
Scanned	67
Third-Octave-Band	67
Universal Audio	91
Variable Bandwidth, Audio	91
Fixture, Test	151, 180
Fixtures, Transistor Test	255
Flange, Adaptor, GR900	260
Flash Delay, Strobe	283
Flash, Stroboscopic	269
Fourier Analyzers	70
Frequency and Time Meter (Counter)	326, 328
Frequency-Response Recorder	49, 52
Frequency-Response Recorder Assemblies	62
Frequency Scaler	325
Frequency Spectrum Analyzers	57, 58, 60
Frequency-Spectrum Analyzers, Real-Time	70
Frequency Synthesizers	222-227

G

Generator, Burst, Strobe	281
Pulse	319, 320
Random-Noise	81, 83, 84
Standard-Signal	232-236
Strobe Multiflash	281
Tone-Burst	321
Graphic Level Recorder	49, 52
Grason-Stadler Audiometer	35
Grason-Stadler Instruments	102

H

HardRATS-Anodize Trim System	123
Hearing Conservation	24
Hearing Research Instruments	102
Hearing Testing	33
Heterodyne Detectors	214
High-Frequency Measuring Systems	201
High-Frequency Oscillators	228
High-Frequency Signal Sources	219
High-Frequency Variac® autotransformers	303
Hi-Reliability Capacitor Testing System	129
Hybrid Trim System, Laser	120

I

I-F Amplifier	215
Impact-Noise Analyzer	27, 45
Impedance Analyzer, RF	202
Bridges	150, 152, 154
Bridge, Automatic	138
Bridge, RF	211
Comparator	147
Measuring System — Computer-Controlled	108, 125
Meter, Digital	140
Meter, UHF	210
Impulse Analyzer	27
Impulse Sound-Level Meter, Precision	45
Incremental-Inductance Bridge	195
Inductance Bridges	193, 195
Bridge, Automatic	138
Comparator	147
Measuring Assembly	192, 194
Meter, Digital	140
Inductor, Decade	198, 199
Inductor, Series, 50- Ω coax, GR874	250

Inductor, Standard	197
Industrial Hearing Conservation	24
Insertion Unit, 50- Ω coax, GR874	250
Insulation Testers, Megohm	181, 182, 183
Integrated-Circuit Tester, Linear	126

J

Jacks and Plugs	334
Joint, Rotary, 50- Ω coax, GR874	248

K

Kits, Coaxial Connector, 50- Ω , GR900	259
Kit, Coaxial Panel Mounting, GR900	260

L

Lamp, Replacement Strobe	278, 279
Laser Trim System	120
Leakage-Current Bridge	164
Measuring System	130
Tester, Megohm	181, 182, 183
Level Regulator, Audio	89
Lights, Stroboscopic	269
Limit Comparator, Analog	149
Digital	144
Line, Air, 50- Ω coax, GR900	265
50- Ω coax, GR874	274
75- Ω coax, GR874	254
Linear Circuit and IC Tester	126
Linear-Speed Wheel, Strobe	284
Line Stretchers, 50- Ω coax, GR874	274
Line-Voltage Control, Variac®	293
Line-Voltage Regulators	285
Logic-Circuit Test Systems	110, 112, 115
Low-Distortion Oscillator	77
Low-Frequency Oscillators	74
Low-Pass Filters, 50- Ω coax, GR874	249
Low-Voltage Variac® autotransformer	312

M

Magnetic Clamp	43
Main Voltage Controllers	269, 293
Matching Pad, 75 to 50- Ω coax GR874	253
GR900	267

Megohm Bridges	181, 182
Megohmmeters	183
Meter, Audio Output Power	90
Impact-Noise	27
Impedance, Digital	140
Impulse Sound-Level	45
Megohm	183
Sound-Level	26, 40
Sound Level, Precision	45
Standing-Wave	216
UHF Admittance	210
Vibration	42
Micronetic Laser Trim System	120
Microphone	93
Microphone Accessories	95
Extension Cable	98
Preamplifiers	95
Preamp Accessories	98
Systems, Condenser	99
Windscreens	97
Microvolter, Audio	92
Militarized Variac® autotransformers	303
MiniRATS-Anodize Trim System	122
Minivolt Adjustable Autotransformer	312
Mixer, 50- Ω coax, GR874	248
Monitor, Noise-Exposure	28
Monitor, Noise-Exposure, Wearable	30
Motion Analysis and Photography Set, Strobe	280
Motion Analyzers, Stroboscopic	269
Motor Controllers	294
Motor-Driven Variac® autotransformers	305
Mount, Component, 50- Ω coax, GR874	250
Mounting Information	339
Mount, Transistor	255
Multichannel Amplifier, Audio	88
Multichannel RMS Detector	69
Multifilter	67
Multiflash Generator, Strobe	281

N

Narrow-Band Analyzer	58, 60
Narrow-Band Analyzer, Automatic	62
Narrow-Band Analyzer, Real-Time	64
N/C Sheetmetal Fabrication	118
Network and Component Testing	105
Network Analyzer, RF	202
Noise Analyzer	57
Calibrators	38

Noise (cont'd)	
Dosimeter	30
Exposure Monitor	28
Exposure Monitor, Wearable	30
Generators, Random	81, 83, 84
Impact Analyzer	27
Impulse Analyzer	45
Measurement	21
Null Detector	162
I-F Amplifier	215
Phase	159

O

Occupational Safety and Health	24
Octave Analyzer	45
(1/3) Analyzer, Stepped	52
(1/3 and 1/10) Analyzer	57
Analyzer, Real-Time	64
Filter	67
Op-Amp Tester	126
Open Circuit, 50- Ω coax, GR874	244
75- Ω coax, GR874	254
Coaxial, GR900	263
Ordering Information	18
Oscillator, Audio	76, 77, 78, 79, 80
Audio to RF	78, 80, 318
Audio and Ultrasonic	77, 78, 80, 158
Bridge	158, 318
Bridge, Audio	79
Decade, Audio RF	80
Detector, Bridge	163
High-Frequency	228
Low-Distortion, Audio	77
Low-Frequency	74
Recorder, Sweep	52
Two-Phase	158
Oscilloscope, Storage	66
Output Power Meter, Audio	90

P

Pad, 50- Ω coax, GR874	245
50- Ω coax, GR900	264
75- Ω coax, GR874	254
Matching, 75-to-50- Ω coax, GR874	253
Matching, 75-to-50- Ω coax, GR900	267
Panel Connectors, 50- Ω coax, GR874	239
75- Ω coax, GR874	252
Passive Test System	108, 125

Patch Cords, Low-Frequency	98, 335
Patch Cords, 50-, 72-, 75- Ω coax, GR874	251
Pens, Audiometer Recording	35
Pens, Recorder	51, 55, 87
Phase Detector	159
Photoelectric Pickoffs	284
Photoflash, Stroboscopic	269
Photography and Motion Analysis Set, Strobe	280
Pickoffs, Photoelectric	284
Pink-Noise Filter	85
Plant-Noise Measurement	24
Plugs and Jack	334
Portable Variac® autotransformers	304
Potentiometers	337
Power Amplifier, Audio	76
Power Cords	336
Power Divider, 50- Ω coax, GR874	248
Power-Line Controller	269, 293
Power Meter, Audio Output	90
Power Supply, Adjustable DC	196
Bias	146
HF Oscillator	230
Preamplifier	97
Preamplifier	163
Accessories	98
Microphone	95
Power Supply	97
VHF/UHF	217
Printer, Digital	145
Probe, Coupling, 50- Ω coax, GR874	250
Product-Noise Reduction	39
Programmable, Amplifier, Multichannel	88
Bio-Medical Instruments	103
Bridges	138, 142
Comparators, Limit	144
Counters	326, 328
Decade Attenuator	246
Decade Resistor	184
Detector, RMS	69
Frequency Synthesizers	222-227
Network Analyzer	204
Recorders	52, 87
Signal Generator	232
Stroboscope	274
Voltage Regulator	289
Psychoacoustics and Audiometry	102
Publications	20
Publications, Strobe	273
Pulse Generators	319, 320

Q

Quiet Rooms34

R

Rack Adaptors338
 Radio-Frequency Bridge211
 Random-Noise Generators .81, 83, 84
 RATS-Anodize Trim System124
 Reactance Charts342
 Real-Time Analyzers64, 70
 Receiver, 30-MHz, I-F Amplifier ..215
 Recorder, Cassette, Audio Data ...47
 DC Strip-Chart86
 Graphic Level49, 52
 Portable47
 Potentiometric49, 52
 Programmable86
 Sound-Level47, 49, 52
 Strip Chart49, 52
 Tape47
 Third-Octave-Band52
 Recording Audiometer35
 Sound and Vibration Analyzer ..62
 Wave Analyzer62, 63
 Rectifier, 50- Ω coax, GR874249
 Reference Resistance Standard ...189
 Reference Standard Capacitors
 174, 175
 Reflectometer, Sweep208
 Regulator, Audio-Level89
 Line-Voltage285
 Resistance Anodize Trimmer
 Systems122, 123, 124
 Bridge, Automatic138
 Bridge, DC181
 Bridge, Limit180
 Bridge, Manual150, 152, 154
 Bridge, Megohm182
 Comparator147
 Meter, Digital140
 Standards, Coaxial191
 Trim Systems120
 Resistive Termination, 50- Ω coax,
 GR874244
 50- Ω coax, GR900263
 75- Ω coax, GR874254
 75- Ω coax, GR900267
 Resistor, Decade184-188
 Programmable Decade184
 Reference Standard189
 Standard190

Resistor (cont'd)

 Trim System, Anodize
 122, 123, 124
 Trim System, Laser120
 Response Analyzer, RF202
 RF Bridge, Impedance211
 RF Bridge, 50-, 75- Ω coax,
 GR874256
 RF Network Analyzer202
 RLC Bridge, Automatic138
 RLC Bridge, Manual150, 152, 154
 RMS Detector, Multichannel69
 Rod and Tube for 50-, 75- Ω Air
 Line, GR874256
 Rod and Tube for 50- Ω Air
 Line, GR900268
 Rooms, Audiometric Examination ..34
 Rotatable Centering Ring, GR900 ..260

S

Sales Offices and Representatives ..12
 Sample Holder, Dielectric166
 Scaler, Frequency325
 Scanned Filter67
 Scanners, System144
 Scanning Amplifier, Multichannel ..88
 SCAT System104
 Screening Audiometer35
 Selection Guide-Automatic Test
 Systems106
 Frequency Synthesizers315
 High-Frequency Signal
 Sources220
 Line-Voltage Regulators285
 Low-Frequency Oscillators ...74
 Microphones99
 Oscillators316
 Product-Noise Reduction39
 Random-Noise Generators81
 Signal Generators314
 Stroboscopes269
 Variac® autotransformers
 295, 311
 Service17
 Shaker Control System, Digital72
 Shaker, Calibration101
 Short Circuit, 50- Ω coax, GR874 ..244
 75- Ω coax, GR874254
 Coaxial, GR900264
 Signal Analyzers56
 Generators, Standard232-236
 Sources314
 Sources, High-Frequency219

Slave Stroboscope280
 Slotted Lines212, 213
 Smith Charts256
 Sorting Systems129
 Sorting Systems, Components147
 Sound-Analysis Systems48
 Sound and Vibration21
 Sound and Vibration Analyzer57
 Sound and Vibration Recording
 Analyzer62
 Sound-Level Calibrators38
 Measurement Sets32
 Meter26, 40
 Meter, Precision45
 Recorder47, 49, 52
 Sound Shelter34
 Sources, Signal314
 S-Parameter Analyzer, RF202
 Spectrum (1/10-Octave) Analyzer ..57
 Analyzers58, 60
 Analyzers, Real-Time64, 70
 Recorder49, 52
 Recorder Assemblies62
 Square-Wave Oscillator77
 Standard-Signal Generators ..232-236
 Standard Capacitors, Air172, 178
 Capacitors, Coaxial 176, 177, 178
 Capacitors, Fixed174, 175
 Capacitors, Mica179
 Capacitors, Variable172
 Inductors197
 Resistance, Coaxial191
 Resistance, Reference189
 Resistor Decades184-188
 Resistors190
 Standing-Wave Meter216
 Standing-Wave Reflectometer208
 Stepped $\frac{1}{3}$ -Octave-Band Analyzer ...52
 Storage Case, GR900268
 Storage Display Unit66
 Strobe Lamp, Replacement ..278, 279
 Strobolume274
 Stroboscopes269
 Stroboslave280
 Strobotac® electronic
 stroboscopes277, 278
 Strobotron, Replacement Lamp ...278
 Stubs, Adjustable, 50- Ω coax,
 GR874244
 Surface-Speed Wheel, Strobe284
 Sweep-Frequency Reflectometer ..208
 Sweep-Frequency Synthesizer225
 Sweep Network Analyzer, RF202
 Sweep, Oscillator/Recorder52

SWR Analyzer, Sweep	202
Meter, Sweep	208
Meter, UHF	210
Synthesizers, Frequency	222-227

T

Tables, Decibel	345
Tables, Reactance	342
Tachometers, Stroboscopic	269
Tantalum-Resistor Trim	
Systems	122, 123, 124
Techware Computer-aided N/C	118
Tee, 50- Ω coax, GR874	248
Tenth-Octave Analyzer	57
Automatic	63
Real-Time	64
Terminations, 50- Ω coax, GR874	244
50- Ω coax, GR900	263
75- Ω coax, GR874	254
75- Ω coax, GR900	267
Testers, Hearing	33
Testers, Logic-Circuit	110, 112, 115
Test Jig	151, 180
Test System, Passive	125
Third-Octave Analyzer	57
Analyzer, Automatic	63
Analyzer, Real-Time	64
Filter	67
Recorder	52
Time and Frequency Meter	
(Counter)	326, 328

Time-Data Time-Series Analyzers	70
Time-Data Digital Vibration	
Control System	72
Time Delay, Strobe	283
Time-Series Analyzers	70
Tone-Burst Generator	321
Tool Kit, coax, GR900	268
Tools, Coax, Crimping, GR874	255
Transformers, Adjustable	293
Transformer Test System	135
Transistor Mounts	255
Trigger, Photoelectric	284
Trimmer Systems,	
Anodize	122, 123, 124
Trim System, Laser	120
Tripod, Microphone	97
Trombone, Air Line, 50- Ω coax,	
GR874	247
Tube and Rod For 50-, 75- Ω Air Line,	
GR874	256
Tube and Rod For 50- Ω Air Line,	
GR900	268
Tuned Amplifier and Null Detector	162
Tuner, 50- Ω coax, GR900	264
Tuning Stubs, 50- Ω coax, GR874	244
TV Strobe Light	274

U

UHF Admittance Meter	210
UHF Preamplifier	217
Ultrasonic Oscillator	77
Universal Filter	91

V

Variable Capacitor, Precision	172
Variac® adjustable	
autotransformers	293
Line-Voltage Regulators	285
Replacement Brushes	312
VHF Preamplifier	217
Vibration and Sound	21
Analyzer	57
Calibrator	101
Control System	72
Meter	42
Pickup Preamplifiers	95
Pickups and Systems	100
Recording Analyzer	62
Video Strobe Light	274
Voltage Calibrator, ac/dc	92
Control Transformers	293
Divider, Decade	323
Regulators, Line	285
Voltmeter Rectifier/Detector, 50- Ω	
coax, GR874	249

W

Walsh-Healey Noise	24
Warranty Statement	17
Wave Analyzers	58, 60
Wave Analyzer, Recording	62, 63
Wearable Noise-Exposure Monitor	30
Wheel, Linear-Speed, Strobe	284
Windscreens, Microphone	97
Wire-Wrapping Systems	116

Index by Type Number

CAP Power Cords	336	874-TPD Power Divider	248	1163 Frequency Synthesizer	226
G-S 1703 Recording Audiometer ..	35	874-U Line Section	248	1164 Frequency Synthesizer	226
M/S 80 Laser Trim System	120	874-UB Terminal Units	243	1165 Frequency Synthesizer	224
M-Series Variac® autotransformers	303	874-UBL Balun	243	1168 Frequency Synthesizer	224
T/D 1923 Time-Series Analyzers ..	70	874-V Voltmeter Rectifier/Detector	249	1191 Counter	326
U2 Variac® autotransformer	296	874-VCL Variable Capacitor	245	1192-B Counter	328
VB Replacement Brushes (Variac) .	312	874-W Terminations, 50- Ω	244	1201-C Power Supply (for 1217-C)	320
W50-P1 Paralleling Choke	312	874-W (75- Ω) Terminations	254	1203-B Power Supply (for 1217-C)	320
W-Series Variac® autotransformers	299	874-X Insertion Unit	250	1211-C Oscillators	228
80 Laser Trim System	120	874-XL Series Inductor	250	1215-C Oscillators	228
274 Adaptors	335	874-Z Stand	255	1217-C Pulse Generator	320
274 Patch Cords	336	880-DCA Precision Directional		1218-BV Oscillator	230
274 Plugs and Jacks	334	Coupler	217	1232-A Tuned Amplifier and Null	
400 ComputerWrap™ Wire-Wrapping		890-BT Basic Coaxial Connector ..	259	Detector	162
System	116	GR900® precision coaxial		1232-P2 Preampifier	163
480 Rack Adaptors	338	components	257	1234 Standing-Wave Meter	216
500 ComputerWrap™ Wire-Wrapping		GR900® 75- Ω coaxial components	266	1236 I-F Amplifier	215
System	116	900 Adaptor Flange	260	1237-A VHF/UHF Preampifier ..	217
510 Decade Resistance Units	187	900 Adaptor Kit	261	1238 Detector	159
600 ComputerWrap™ Wire-Wrapping		900 Rod and Tube, 50- Ω	268	1240 Bridge Oscillator/Detector ..	163
System	116	900 Rotatable Centering Ring ..	260	1241 Heterodyne Detectors	214
776 Patch Cords	335	900 Storage Case	268	1262-B Power Supply	41
777 Adaptors	335	900-A Basic Connector Kits, 50- Ω	259	1262-C Power Supply	43
GR874® coaxial components	237	900-BT Basic Precision Connectors		1263-C Amplitude-Regulating Power	
GR874® 75- Ω coaxial components	252	(50- Ω)	259	Supply	230
874 Tube and Rod	256	900-BT (75- Ω) Basic Connector ..	266	1264-B Modulating Power Supply	230
874-A Cable	251	900-C 50- Ω Cable Connectors ..	260	1265-A Adjustable DC Power	
874-B Basic 50- Ω Connector	238	900-EL 90° EII	268	Supply	196
874-B (75- Ω) Basic Connector	252	900-G Attenuators, 50- Ω	264	1267-B Regulated Power Supply ..	230
874-BR RF Bridges	256	900-L Air Lines	265	1269-A Power Supply	230
874-C 50- Ω Cable Connectors	239	900-LB Slotted Line	213	1308-A Audio Oscillator and Power	
874-C (75- Ω) Cable Connectors ..	252	900-LZ Reference Air Lines	265	Amplifier	76
874-D Adjustable Stubs, 50- Ω ..	244	900-MP Matching Pad	267	1309-A Oscillator	77
874-EKA Basic Slotted Line Kit ..	212	900-PKM Panel Mounting Kit	260	1310-B Oscillator	78
874-EL EII	248	900-Q 50- Ω Adaptors	261	1311-A Audio Oscillator	79
874-F Low-Pass Filters	249	900-Q 75- Ω Adaptors	266	1312 Decade Oscillator	80
874-FBL Bias Insertion Unit	250	900-TOC Cleaning Kit	268	1316 Oscillator	158
874-G Attenuators, 50- Ω	245	900-TOK Tool Kit	268	1330-A Bridge Oscillator	318
874-G (75- Ω) Fixed Attenuators ..	254	900-TUA Tuner	264	1340 Pulse Generator	319
874-JR Rotary Joint	248	900-W 50- Ω Terminations and		1346 Audio-Frequency Microvolter	92
874-K Coupling Capacitor	250	Mismatches	263	1361 Oscillators	230
874-L Air Lines, 50- Ω	247	900-W 75- Ω Termination	267	1362 Oscillators	229
874-L (75- Ω) Rigid Air Line	254	938 Binding Posts	332	1363 Oscillators	229
874-LBB Slotted Line	212	940 Decade-Inductor Units	199	1381 Random-Noise Generator	81
874-LV Micrometer Vernier	212	970-Series Potentiometers	337	1382 Random-Noise Generator	81
874-MB Coupling Probe	250	1000 Signal-Generator Accessories	236	1383 Random-Noise Generator	83
874-ML Component Mount	250	1001-A Standard-Signal Generator	236	1390-B Random-Noise Generator ..	84
874-MP Matching Pad	253	1003 Standard-Signal Generator ..	232	1390-P2 Pink-Noise Filter	85
874-MR Mixer/Rectifiers	248	1026 Standard-Signal Generator ..	234	1396-B Tone-Burst Generator	321
874-P 50- Ω Panel Connectors	239	1061 Frequency Synthesizer	222	1403 Standard Air Capacitors	178
874-P (75- Ω) Panel Connectors ..	252	1062 Frequency Synthesizer	222	1404 Reference Standard	
874-Q 50- Ω Adaptors	240	1065 Sweeping Frequency		Capacitor	175
874-Q (75- Ω) Adaptors	252	Synthesizer	225	1405 Coaxial Capacitance	
874-R Patch Cords	251	1157-B Scaler (500 MHz)	325	Standards	176
874-T Tee	248	1161 Frequency Synthesizer	226	1406 Coaxial Capacitance	
874-TO Crimping Tools and Kit ..	255	1162 Frequency Synthesizer	226	Standards	177