

GenRad 1933
Precision Sound Level Meter
and Analyzer
User Guide and Service Manual



IET LABS, INC.
formerly manufacturer by
GenRad

534 Main Street, Westbury, NY 11590 www.ietlabs.com
TEL: (516) 334-5959 • (800) 899-8438 • FAX: (516) 334-5988



IET LABS, INC.

534 Main Street, Westbury, NY 11590

Tel (516) 334-5959 (800) 899-8438 Fax (516) 334-5988 <http://www.ietlabs.com>

Manual & Programmable Standards, Substituters, & Test Instruments

- New Products
 - Find a Product
 - Technical Applications
 - Request a Quote
 - Price List
 - Place an Order
 - Request a Catalog
 - Contact Us
 - About IET
- If you need products or service by Genrad, esi, Biddle, or others.

STANDARDS, DECADES STROBES

Formerly Manufactured By:
QuadTech/GenRad(General Radio)

Now being manufactured, serviced, calibrated, and fully supported by IET LABS

COST-EFFECTIVE QUALITY STANDARD OR CUSTOM SOLUTION
R-L-C•RTD•VOLTAGE
CURRENT•PROCESS CONTROL

Product Area of Interest



Widest Choice of Decades

IET is compliant with ISO 9001, ISO/IEC 17025, ANSI Z540-1-1994, and MIL-STD-45662A

Calibration Test Measurement Metrology

[Find a Products](#) | [Technical Applications](#) | [Request a Quote](#) | [Place an Order](#) | [Free Offer](#) | [Request a Catalog](#) | [Contact Us](#)

© Copyright 1999 - 2001 IET Labs, Inc. All rights reserved.
Problems or Comments? Contact webmaster@ietlabs.com

To navigate our easy to use website for quick access to specifications and prices:

1. Select **Find a Product** to go to a convenient scrolling thumbnail catalog and then to detailed data sheets as desired; or:
2. Select **STANDARDS DECADES STROBES** for products formerly manufactured by **GenRad (General Radio)** or **QuadTech**.

Since 1976, IET labs has had a long-standing commitment to **conform the instruments and standards we offer to the customer's needs** rather than to have the customer settle for what is available. We devote our customer service and applications entirely to the customer's satisfaction in the quality standards, test instruments and calibration service we provide.

- Combinations of functions, special ranges, ratings, or accuracies.
- Replacement for discontinued models from other manufacturers.
- Calibration and repair services - NIST traceable.
- Compliant with ISO 9001, ISO 17025, ANSI Z540-1-1994, and MIL-STD-45662A.

Capabilities

- R: 20 $\mu\Omega$ -1 T Ω
- C: <1 pF - 1 F
- L: 100 μ H-100 H
- Accuracy to 1 ppm
- Resolution to 0.1 ppm
- Voltage to 20 kV
- Power to over 1000 W
- Programmable IEEE-488 or BCD



The World Standard in Metrology
Since 1915
Now continuing the **GenRad** tradition

Featuring instruments formerly manufactured by **GenRad/General Radio/QuadTech**

Contents

SPECIFICATIONS
CONDENSED OPERATING INSTRUCTIONS
INTRODUCTION – SECTION 1
OPERATION – SECTION 2
THEORY – SECTION 3
SERVICE AND MAINTENANCE – SECTION 4
PARTS AND DIAGRAMS – SECTION 5
APPENDIX – TYPE 1940

This instrument is capable of making sound level measurements required under Part 1910.95 "Occupational Noise Exposure," (Dept of Labor) of the Code of Federal Regulations, Chap. XVII of Title 29 (36 F.R. 7006). Ref: Federal Register, Vol 36, No. 105, May 29, 1971.

Type 1933
Precision Sound-Level Meter
and Analyzer

(GR 1940 POWER SUPPLY AND CHARGER)

C

©GENERAL RADIO COMPANY 1973

Concord, Massachusetts, U.S.A. 01742

Form 1933-0100-C

November, 1974

ID-5556

Specifications

This instrument carries U.S. Bureau of Mines approval for use in gassy coal mines — Approval No. 2G-2544.

Specifications meet ANSI S1.4-1971 for Type 1 (precision) Sound-Level Meters; IEC 179-1965 for Precision Sound-Level Meters; IEC 123-1961 for Sound-Level Meters; ANSI S1.11-1966 for Octave, Half-Octave, and Third-Octave Band Type 0 Class II Filter Sets; IEC 225-1966 for Octave, Half-Octave, and Third-Octave Band Filters for the Analysis of Sound and Vibrations; and Proposed IEC 179 amendment for impulse measurement.

Level Range: 10 to 130 dB re $20 \mu\text{N/m}^2$ with 1-in. microphone, 20 to 140 dB with $\frac{1}{2}$ -in. microphone, in 10-dB steps.

Typical minimum measurable level — with 1-in. microphone, 22 dBA; with $\frac{1}{2}$ -in. microphone, 31 dBA; lower in octave bands.

Frequency: 5 Hz to 100 kHz essentially flat response, 10 octave bands with center frequencies from 31.5 Hz to 16 kHz; plus A, B, and C weighting.

Display: METER: 20-dB scale linearly marked in dB and lower, center, and upper values automatically indicated on scale. Highest accuracy obtained by using upper 10 dB as measuring range. RESPONSE: Fast, slow, absolute peak, and impulse (per IEC 179 amendment), pushbutton selected. Precise rms detection for signals with ≤ 20 -dB crest factor at full scale; crest-factor capacity greater below full scale. OVERLOAD: Signal peaks monitored at 2 critical points to provide positive panel-lamp warning. RANGING: Automatic system (OPTI-RANGE) maximizes analyzing range and signal-to-noise ratio for each level range-control setting; manual control provides override.

Filters: WEIGHTING: A, B, C, and flat; pushbutton selected. OCTAVE BANDS: 10, manually selected, with 3.5 ± 1 -dB attenuation at nominal cutoff, > 18 -dB attenuation at $\frac{1}{2}$ and 2X center frequency, > 70 -dB ultimate attenuation. EXTERNAL FILTERS can be substituted for internal weighting networks and octave-band filters; connect to 2 miniature phone jacks.

Input: $\frac{1}{2}$ -in. or 1-in. electret-condenser microphone with flat response (random or perpendicular incidence); mounted with detachable preamplifier on 12-in. extendible mast, or on 10-ft. extension cable supplied, or on 60-ft. cable available. Input can also be from tape recorder. INPUT IMPEDANCE: $2 \text{ G}\Omega // < 3 \text{ pF}$.

Output: SIGNAL OUTPUT: 0.5 V rms behind 600Ω corresponding to full-scale meter deflection, any load permissible. RANGE CODE: Contact closure provides sound-level-meter range information to 1935 Cassette Data Recorder. DETECTED OUTPUT: 4.5 V dc behind $4.5 \text{ k}\Omega$ corresponding to full-scale meter deflection, output is linear in dB at 0.1 V/dB over 60-dB range (40-dB normal range plus 20-dB crest-factor allowance), any load permissible.

Calibration: FACTORY: Fully tested and calibrated to all specifications; acoustical response and sensitivity are measured in a free field by comparison with a WE640AA Laboratory Standard Microphone whose calibration is traceable to the U.S. National Bureau of Standards. ON-SITE: Built-in calibrator provides quick test of electrical circuits; GR 1562 Sound-Level Calibrator is available for simple test of over-all calibration, including microphones.

Environmental: Performance meets specifications of standards listed above. TEMPERATURE: -10 to $+50^\circ \text{C}$ operating, -40 to $+60^\circ \text{C}$ storage with batteries removed. HUMIDITY: 0 to 90% RH. VIBRATION AND MICROPHONICS: Conform to applicable ANSI and IEC standards.

Noise Floor: With 1-in. electret mike, 17 dBA; with $\frac{1}{2}$ -in. electret, 26 dBA. Both lower in octave band measurements.

Accessories Supplied: Microphone attenuator, tool kit, 10-ft. microphone extension cable, batteries.

Accessories Available: 1940 Power Supply and Charger, electret-condenser microphones, ceramic microphone cartridge and adaptor, earphone, tripod, cables, and windscreens.

Power: 4 alkaline energizer C cells supplied provide ≈ 20 -h operation; 1940 Power Supply and Charger allows line operation of 1933 and includes rechargeable batteries and charging source. Battery check provided on 1933.

Mechanical: Small, rugged, hand-held case with standard 0.25-20 threaded hole for tripod mounting. DIMENSIONS (wxhxd): 6.25 x 9 x 3 in. (159 x 229 x 76 mm). WEIGHT: 5.5 lb (2.5 kg) net, 10 lb (4.6 kg) shipping.

Description	Catalog Number
1933 Precision Sound-Level Meter and Analyzer (Conforms to IEC 179 and ANSI S1.4-1971, Type 1)	
With $\frac{1}{2}$ -in. and 1-in. flat random-incidence response Electret-Condenser Microphone	1933-9700
With $\frac{1}{2}$ -in. flat random-incidence response Electret-Condenser Microphone only	1933-9701
1933 Precision Sound-Level Meter and Analyzer (Conforms to IEC 179 - recommended for European countries)	
With $\frac{1}{2}$ -in. and 1-in. flat perpendicular-incidence response Electret-Condenser Microphones	1933-9702
With $\frac{1}{2}$ -in. flat perpendicular-incidence response Electret-Condenser Microphone only	1933-9703
Accessories Available	
Electret-Condenser Microphones	
Flat random-incidence response, 1-in.	1961-9601
Flat perpendicular-incidence response, 1-in.	1961-9602
Flat random-incidence response, $\frac{1}{2}$ -in.	1962-9601
Flat perpendicular-incidence response, $\frac{1}{2}$ -in.	1962-9602
Ceramic Microphone Cartridge and Adaptor, 1-in.	1560-9570
Earphone	1935-9601
Tripod	1560-9590
Cables	
Microphone extension cable, 60 ft.	1933-9601
Miniature phone plug to 1933 microphone mast	1933-9602
Miniature phone plug to double banana plug	1560-9677
Miniature phone plug to standard phone plug	1560-9678
Miniature phone plug to BNC	1560-9679
Windscreens, reduce wind noise, protect against contaminants	
For 1-in. microphone, set of 4	1560-9521
For $\frac{1}{2}$ -in. microphone, set of 4	1560-9522
1562-A Sound-Level Calibrator	1562-9701
Battery, spare for 1933, uses 4	8410-1500

Warranty

We warrant that this product is free from defects in material and workmanship and, properly used, will perform in full accordance with applicable specifications. If, within a period of ten years after original shipment, it is found, after examination by us or our authorized representative, not to meet this standard, it will be repaired or, at our option, replaced as follows:

- No charge for parts, labor or transportation during the first three months after original shipment;
- No charge for parts or labor during the fourth through the twelfth month after original shipment for a product returned to a GR service facility;
- No charge for parts during the second year after original shipment for a product returned to a GR service facility;
- During the third through the tenth year after original shipment, and as long thereafter as parts are available, we will maintain our repair capability and it will be available at our then prevailing schedule of charges for a product returned to a GR service facility.

This warranty shall not apply to any product or part thereof which has been subject to accident, negligence, alteration, abuse or misuse; nor to any parts or components that have given normal service. This warranty is expressly in lieu of and excludes all other warranties expressed or implied, including the warranties of merchantability and fitness for a particular purpose, and all other obligations or liabilities on our part, including liability for consequential damages resulting from product failure or other causes. No person, firm or corporation is authorized to assume for us any other liability in connection with the sale of any product.

Condensed Operating Instructions

a. Lift the top cover, install the desired microphone and extend the microphone mast to its full length.

b. Set the MANUAL OVERRIDE control (under top cover) to AUTO. Push in the knurled MAX MIKE dB control (left side panel) and turn it to the position indicated by the chart inside the top cover. The proper setting is given adjacent to the serial number of the microphone being used. (The serial number of the microphone is marked on the ring which is visible inside the threaded end. When the 10 dB Attenuator is used with the 1/2 inch mike, its serial number governs.)

c. Push the ON-OFF button (front panel) to turn the instrument on and then the BAT CHECK button. The meter should indicate above the BATTERY mark. Again press and then release the BAT CHECK button to return the instrument to normal operation.

d. Use the dB LEVEL control (lower major control on right side panel) to align the CAL arrows on the "MAX MIKE dB" control (left side panel). Select the 1 kHz octave band using the BAND control (upper major control on right side panel) and set the SOURCE control (under top cover) to CAL. The meter should read at full scale, indicating that

the instrument is in calibration and ready for use. If it does not, the reading may be adjusted using the CAL screwdriver control located on the top panel, under the top cover.

e. Set the SOURCE control to A or B as indicated by the cover chart, adjacent to the serial number of the microphone in use, and the instrument is ready for operation.

f. Select WEIGHTING using the BAND control and push the desired WEIGHTING button (A, B, C or FLAT on the front panel). Adjust the dB LEVEL control for an on-scale meter deflection and read the meter.

g. To measure an octave band level, select the desired band using the BAND control, adjust the dB LEVEL control for an on-scale meter deflection and read the meter.

h. The meter characteristic is normally at FAST. It may be set to SLOW by pressing the METER SLOW button on the front panel. To select IMPULSE or PEAK (IMPACT), check that the slide switch on the right side panel is set to the appropriate position and then push the METER IMP button on the front panel. Note that the SLOW and IMP buttons are not interlocked so that one must be released before the other can be depressed.

Introduction—Section 1

1.1	PURPOSE	1-1
1.2	DESCRIPTION	1-1
1.3	CONTROLS, CONNECTORS AND INDICATORS	1-1
1.4	ACCESSORIES SUPPLIED	1-4
1.5	ACCESSORIES AVAILABLE	1-6
1.6	SOUND ANALYSIS SYSTEMS	1-6
1.7	POWER SUPPLY AND CHARGER	1-6

1.1 PURPOSE.

The Type 1933 Precision Sound-Level Meter and Analyzer is a light-weight, portable sound analyzer intended to make precision sound-level measurements and octave band analyses. It operates for 20 hours on self contained batteries and is ideally suited for field use. Its unique "opti-range" design permits one-knob control of the level range. In addition to making measurements on-site, the 1933 operates with its accessory 1935 Cassette Data Recorder to collect data for later analysis in a laboratory.

The 1933 is capable of making all measurements required under the Safety and Health Standards of the Walsh-Healey Public Contracts Act (41USC 351, et seq.) and the Occupational Safety and Health Act (OSHA) of 1970 (84 STAT. 1590) including the measurement of the absolute-peak sound-level of impact sounds.

The 1933 complies fully with the following standards:
ANSI Standard Specification for Sound-Level Meters, S1.4-1971, Type 1 (Precision)

IEC Recommendation Publication 179-1965; Precision Sound-Level Meters

Current Draft Supplement to IEC Publication 179; Precision Sound-Level Meters, Additional requirements for the measurement of Impulsive Sounds

IEC Recommendation Publication 123-1961, Sound-Level Meters

ANSI Standard Specifications for Octave, Half-Octave, and Third-Octave Band Filter Sets, S1.11-1966, Type 0, Class II.

IEC Recommendation Publication 225-1966 Octave, Half-Octave and Third-Octave Band Filters For the Analysis of Sounds and Vibrations.

1.2 DESCRIPTION

The 1933 Precision Sound-Level Meter and Analyzer is a portable sound analyzer including the facilities of an

impulse precision sound-level meter and an octave band spectrum analyzer. It includes A, B, and C weighting characteristics and ten octave band filters with band center frequencies from 31.5 Hz to 16 kHz. It has an additional flat frequency response extending from 5 Hz to 100 kHz. External filter jacks permit the use of special weighting or filters in place of the built-in filter networks. The instrument has three selectable detector systems: (1) a true rms detector with fast or slow characteristics, (2) an impulse detector that indicates the peak of the short time rms value and (3) an absolute peak detector. The indicating meter has a linear decibel scale that covers a range of 20 dB. There are thirteen selectable 20 dB ranges allowing the instrument to read directly levels ranging from 10 to 150 dB re $20/\mu\text{N}/\text{m}^2$ with appropriate microphones.

The 1933 is available with 1 inch and 1/2 inch microphones. The microphone is connected to a detachable preamplifier which is mounted on an extendable mast. Gain can be preset for any two microphones so they can be quickly changed without the need for calibration.

The controls and indicators are arranged conveniently and efficiently on the instrument. A unique automatic system ("opti-range") eliminates the need for multiple or concentric level controls (attenuators) normally required with all spectrum analyzers. An ac signal output is provided for driving other equipment such as analyzers, graphic level recorders, or magnetic tape recorders. A dc output, proportional to the logarithm of the detected signal (linear in decibels with a range of 60 dB), is available for driving a dc recorder. A multi-pin data output connector provides range data and signal to the companion GR 1935 Cassette Data Recorder.

1.3 CONTROLS, CONNECTORS AND INDICATORS

The controls, connectors, and indicators are identified in Figures 1-1, 1-2, and 1-3; their functions are described in Tables 1-1, 1-2, and 1-3.

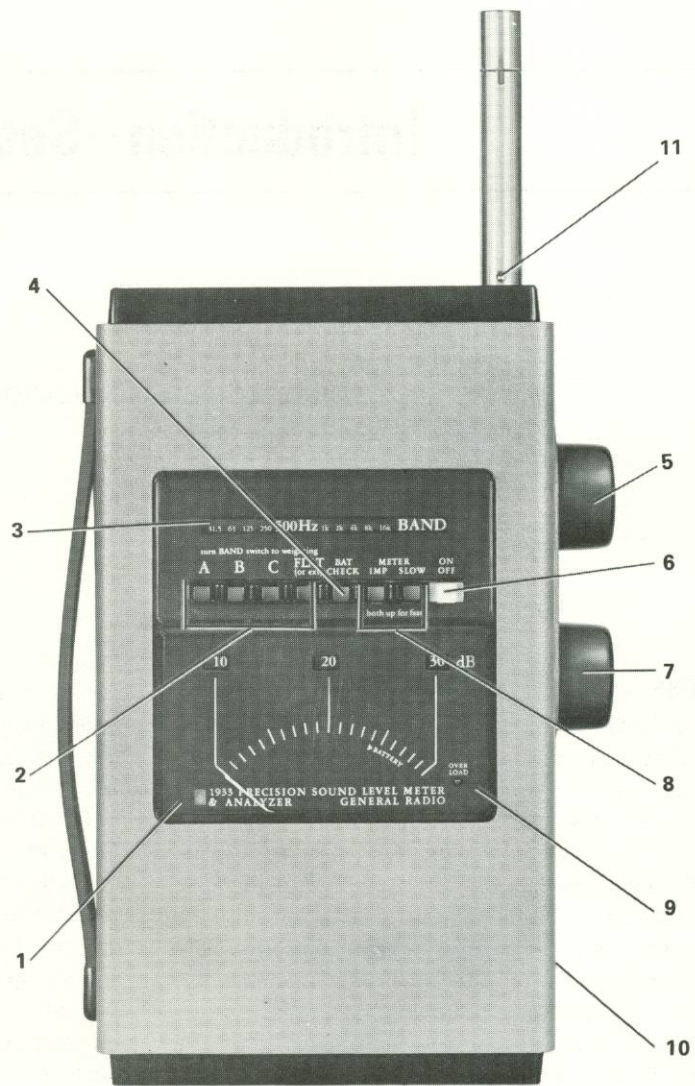

Figure 1-1. Controls and indicators for 1933. (Front view). The microphone mast (upper right) is elevated, but not extended.

Table 1-1
CONTROLS AND INDICATORS

Fig. 1-1 Name	Name	Description	Function
1	Meter Face	Recessed meter with dB scale adjustable by means of dB LEVEL knob on right side panel.	1. Indicates dB levels ranging from 10 dB bottom scale to 150 dB top scale. Eleven of thirteen ranges are selected by the dB level knob. The overall ranges: 10-130, 20-140 and 30-150 dB are determined by the MAX MIKE dB knob (left side panel). 2. Indicates condition of battery when BAT CHECK button is depressed. 3. Indicates calibration condition – Full Scale – when SOURCE (top panel) and MAX MIKE dB (left side panel) are at CAL and the octave band center frequency is 1 kHz.
2	A, B, C, FLAT (or EXT) buttons	4 interlocked latching pushbuttons	Selects A, B, or C weighting characteristic or Flat response (5 Hz-100 kHz) when instrument is in WEIGHTING mode.
3	Octave Band/Weighting Indicator	11 position drum indicator driven with BAND switch knob on right side panel	Indicates geometric center frequency of the selected octave filters and indicates when instrument is in WEIGHTING mode. Marked from left to right, 31.5 Hz, 63 Hz, 125 Hz, 250 Hz, 500 Hz, 1 kHz, 2 kHz, 4 kHz, 8 kHz, 16 kHz, and weighting.

Table 1-1 (cont)
CONTROLS AND INDICATORS

Fig. 1-1 Ref.	Name	Description	Function
4	BAT CHECK button	Latching pushbutton with push-release action	Selects battery check mode. Can be left in battery check position so battery condition can be monitored when instrument is used as preamplifier.
5	BAND switch	Knob—11-position rotary switch	Selects one of 10 octave BAND center frequencies or WEIGHTING mode.
6	ON/OFF button	Latching pushbutton with push release action	Turns instrument ON when depressed.
7	dB LEVEL	Knob—11-position rotary switch	Selects meter range as indicated on meter face.
8	METER IMP-SLOW buttons	2 latching pushbuttons with push release action so both buttons can be released.	IMP button selects impulse or peak meter characteristics depending on position of IMPULSE/PEAK (IMPACT) switch on right side panel. SLOW button selects slow meter characteristics. When IMP and SLOW buttons are released the meter characteristic is fast.
9	OVERLOAD indicator	Lamp	Illuminates when an overload condition occurs indicating that the meter reading is invalid. Also indicates in the MANUAL OVER-RIDE mode, when the dB level control has been incorrectly set.
10	IMPULSE/PK(IMPACT)	2-position slide switch (on side)	Determines whether IEC impulse response or peak response will be selected by the panel METER-IMP button.
11	—	Preamplifier latch button	To remove preamplifier, push button and pull unit off.

Figure 1-2. Top surface of 1933, shown with cover open for access to controls. The microphone mast (1-in. unit installed) is shown in stowed position. The ½-in. microphone in its storage socket is at lower right.

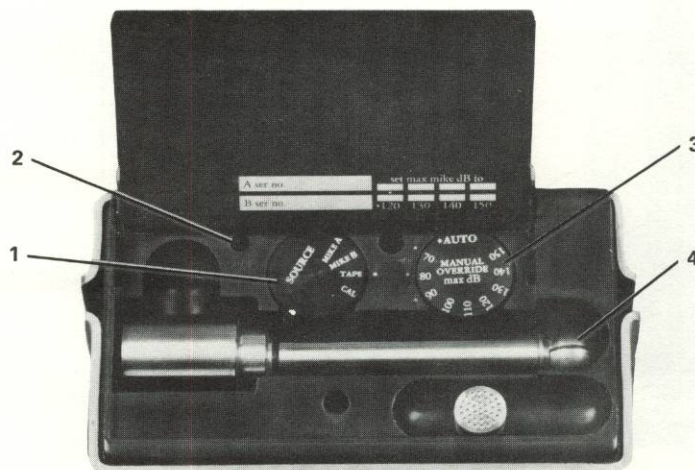

Table 1-2
TOP PANEL CONTROLS AND CONNECTOR

Fig. 1-2 Ref.	Name	Description	Function
1	SOURCE	4-position rotary switch	Selects gain of instrument to accommodate the source being used and selects internal calibrator.
2	CAL	Recessed screwdriver control	Adjusts overall gain of instrument for calibration.
3	MANUAL OVERRIDE	7-position rotary switch	Selects normal AUTO operation and serves as manual input range control to set maximum input level.
4	NONE	Microphone Preamplifier and Extendible Mast	Input connection from microphone.

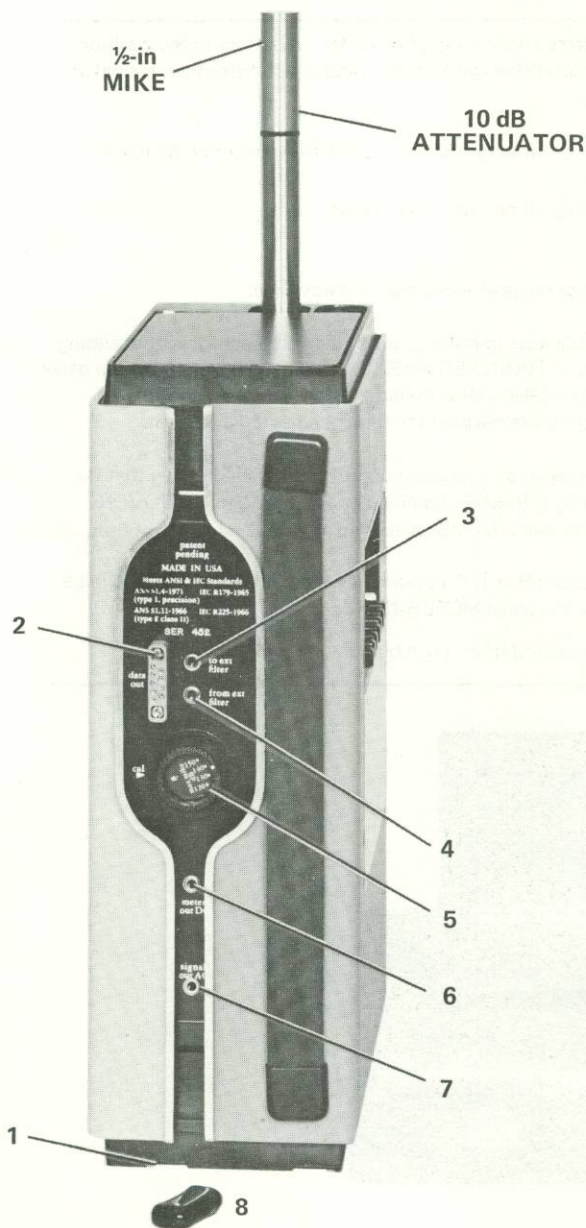

Figure 1-3. Side-panel controls and indicator; cover for DATA OUT jack in foreground.

Table 1-3
CONTROLS AND CONNECTORS

Fig. 1-3 Ref.	Name	Description	Function
1	EXTERNAL POWER (Not labeled)	5-flush mounted banana plug receptacles.	Provides connection to 1940 Power Supply and Charger (See Appendix)
2	DATA OUT	Miniature 9-pin connector	Provides connection to GR 1935 Cassette Data Recorder
3	TO EXT. FILTER	Miniature phone jack	Connects to input of external filter (minimum load impedance is 600 Ω)
4	FROM EXT. FILTER	Miniature phone jack	Connects to output of external filter (input impedance 60 k Ω)
5	MAX MIKE dB	Concentric dial and knurled knob	Selects range of dB level control to match sensitivity of microphone in use. Dot on rim of knurled knob aligns with "MAX MIKE dB" dot on inner dial according to information in table inside top cover. For calibration, aligns arrow C with arrow CAL by turning dB LEVEL control on right side.
6	METER OUT DC	Miniature phone jack	Provides 4.5 volts dc output behind 4.5 k Ω corresponding to full scale meter deflection. Linear in dB at 0.1 V/dB over 60 dB range. Any load resistance can be connected.
7	SIGNAL OUT AC	Miniature phone jack	Provides ac signal output of 0.5 volts rms behind 600 Ω corresponding to full scale meter deflection, any load permissible.
8	Battery connections	8-spring battery contacts	Makes connections to 4 C cells (alkaline or rechargeable NICAD). Sliding panel covers and holds batteries in place.
	TRIPOD mount (not shown) located on rear panel.	1/4-20 threaded bushing	Permits mounting on a tripod.

1.4 ACCESSORIES SUPPLIED

The accessories supplied with the 1933-9700, 9701, 9702 and 9703 Precision Sound-Level Meter and Analyzer are listed in Table 1-4.

1.5 ACCESSORIES AVAILABLE

The accessories available for use with the 1933-9700, -9701, -9702, -9703 Precision Sound-Level Meter and Analyzer are listed in Table 1-5.

Table 1-4
ACCESSORIES SUPPLIED

Quantity	Description	Part Number
4	Batteries (alkaline C cells)	
1	10-ft EXTENSION CABLE (preamplifier to mast)	1933-9600
2	Miniature phone plugs (Switchcraft 850-PL)	4270-1110
1	Screwdriver for CAL adjustment	(1933-2200)
1	Electret Condenser Microphone, 1/2"	1962-9601 or -9602*
1	10 dB attenuator for 1/2" Electret microphone	1962-3200
1	Electret Condenser Microphone, 1" (with 1933-9700 and 1933-9702 only)	1961-9601 or -9602*

*Microphone with -9601 suffix supplied with 1933-9700 and 1933-9701
Microphones with -9602 suffix supplied with 1933-9702 and 1933-9703

Table 1-5
ACCESSORIES AVAILABLE

Name	Description	Part Number
BATTERIES	Alkaline Energizer C cells (4 required) Burgess AL1, Eveready E93, Mallory MN1400 or equivalent (4 required)	
MICROPHONES	(Flat Random Incidence Response)	
	1 inch Electret Condenser	1961-9601
	1/2 inch Electret Condenser	1962-9601
	1 inch Ceramic	1560-9570
	1/2 inch Ceramic	1972-9601
MICROPHONES	(Flat Perpendicular Response):	
	1 inch Electret Condenser	1961-9602
	1/2 inch Electret Condenser	1962-9602
CABLES	Microphone extension cable, 60 ft.	1933-9601
	Miniature phone plug to 1933 microphone mast	1933-9602
	Miniature phone plug to double banana plug	1560-9677
	Miniature phone plug to BNC	1560-9679
	Miniature phone plug to standard phone plug	1560-9678
	Miniature phone plug to standard phone jack	1560-9680
	Miniature phone plug to special double banana plug (for Simpson 2745 recorder)	1560-9675
WINDSCREENS	For 1/2 in. microphone, set of 4	1560-4522
	For 1 inch microphone, set of 4	1560-4521
SOUND-LEVEL CALIBRATOR	Provides a precise sound-pressure level at five ANSI preferred frequencies	1562-9702
TRIPOD	Thread mounts (1/4-20) to back of 1933	1560-9590
DATA RECORDER	Two channel, two track magnetic tape recorder using the Philips Cassette format	1935-9701
POWER SUPPLY AND CHARGER	Provides for line operation of 1933 and for charging NICAD batteries (supplied with Power Supply and Charger).	1940-9701
Dummy Microphone	35 pF BNC .460-60	1560-9609

1.6 SOUND ANALYSIS SYSTEMS

The 1933 Precision Sound-Level Meter and Analyzer is available as part of six complete sound analysis systems. Each system is made up of the Sound-Level Meter and Analyzer with selected accessories packaged in a durable traveling case. The case has foam liners with cutouts to accommodate components of the system. A file folder is supplied for storage of instruction manuals, notes, and data.

Sound-Analysis Systems 1933-9714 and -9715

These systems are assembled in an attache case, 1933-9714 (with random incidence microphones) and 1933-9715 (with perpendicular incidence microphones). Case dimensions are L x W x D = 18-3/8 x 15 x 6 1/4 inches overall. They include all of the accessories listed in Table 1-4 for the 1933-9700 and 9702 and in addition the following:

- 1 – Carrying and storage case (attache size)
- 1 – Windscreen for 1 inch microphone
- 1 – Windscreen for 1/2 inch microphone
- 1 – Dummy microphone 1560-P9 (35 pf to simulate 1/2 inch electret-condenser microphone)
- 1 – Sound-Level Calibrator, 1562 with: Instruction Manual
 - Adaptor for 1 inch microphone
 - Adaptor for 1/2 inch microphone
 - Battery
- 1 – Earphone (ear-insert type) for monitoring signal from 1933.

Sound Analysis Systems 1933-9710 and -9711

These systems include more equipment than the 1933-9714 and -9715 systems. Case dimensions are L x W x D = 22-3/16 x 15-3/8 x 8-5/8 inches overall. They include all the accessories listed in Table 1-4 for the 1933-9700 and -9702 and in addition the following:

- 1 – Carrying and storage case (carry on size)
- 1 – Windscreen for 1 inch microphone
- 1 – Windscreen for 1/2 inch microphone
- 1 – Dummy microphone 1560-P9 (35 pf to simulate 1/2 inch electret condenser microphone)
- 1 – Sound-Level Calibrator 1562 with: Instruction Manual
 - Adaptor for 1 inch microphone
 - Adaptor for 1/2 inch microphone
 - Battery
 - Carrying case

- 1 – 60 ft. microphone extension cable on reel
- 1 – Tripod
- 1 – Earphone (ear-insert type) for monitoring signal from 1933.

Sound Analysis System 1933-9712 and -9713

These systems include all the components of the 1933-9710 and -9711 systems plus a companion cassette data recorder and its accessories. Case dimensions are L x W x D = 22-3/16 x 15-3/8 x 8-5/8 inches overall. They include all the accessories included with the 1933-9710 and -9711 systems, and in addition the following:

- 1 – Cassette Data Recorder 1935-9700 with its accessories including
 - 1 – 30 minute standard cassette
 - 5 – Batteries (alkaline c cells)
- 1 – Coiled cable to connect Sound Level Meter and Analyzer to Data Recorder.
- 1 – Playback cable to connect output of recorder to input at mast of analyzer.

1.7 POWER SUPPLY AND CHARGER

The 1940 Power Supply and Charger allows the 1933 Precision Sound-Level Meter and Analyzer or the 1935 Cassette Data Recorder to be operated from the power line independently of its internal batteries and also serves as a battery charger. The Power Supply and Charger is supplied with a set of five rechargeable NICAD batteries (four required for 1933, five for 1935) to replace the alkaline C cells.

The analyzer plugs directly into the Power Supply and Charger which also serves as a convenient bench stand. When the supply is connected to a power line, the analyzer is supplied power from a source independent from the battery while simultaneously, the batteries are charged. Alternately, in the BATTERY mode, the instrument will operate from its batteries while mounted on the charger. Lamps indicate when the charger is connected to an active power line and when the batteries are fully charged. When the BATTERY CHARGED light is on, the batteries are maintained in the fully charged condition by trickle charging. Power to the charger and instrument may be switched by external means in the LINE mode. When power is disconnected the instrument will cease to operate rather than taking power from its own batteries.

Operation—Section 2

2.1	SETUP AND CALIBRATION	2-1
2.2	AUTOMATIC OPERATION	2-2
2.3	OVERLOAD INDICATOR	2-3
2.4	CHECKING AND CHANGING BATTERIES	2-5
2.5	SIGNAL OUT AC JACK	2-5
2.6	METER OUT (DC) JACK	2-5
2.7	USE OF FILTER JACKS	2-6
2.8	CHANGING MICROPHONES	2-6
2.9	PROXIMITY EFFECTS OF CASE AND OBSERVER	2-6
2.10	EXTENSION CABLES	2-7
2.11	USE OF MANUAL OVERRIDE CONTROL	2-8
2.12	USE OF SOURCE CONTROL	2-8
2.13	DATA OUT CONNECTOR	2-8
2.14	USE WITH ACCELEROMETERS	2-8
2.15	ENVIRONMENTAL EFFECTS	2-9
2.16	INTERNALLY GENERATED NOISE	2-10
2.17	USE OF ACCESSORIES	2-10
2.18	1940 POWER SUPPLY AND CHARGER	2-11
2.19	USING A DC RECORDER	2-12
2.20	USING THE SOUND-LEVEL METER AS A PREAMP	2-12

2.1 SET UP AND CALIBRATION

Before making measurements with the 1933, check that the SOURCE control, MANUAL OVERRIDE control, and MAX MIKE dB control are properly set and that the battery voltage is adequate. See 2.12 Use of Source Control, 2.11 Use of Manual Override Control, 2.8 Changing Microphones and 2.4 Checking and Changing the Batteries for procedures. Then check calibration using either the internal electrical calibrator or the 1562 Sound-Level Calibrator.

Calibration should be performed with the 1933 stabilized at the ambient temperature. If this ambient temperature is outside the range of +10° to +35°C (50° to 95° F) special calibration procedures are required. If an internal electrical calibration is performed, correct each subsequent sound-level reading by an amount equal and opposite to the sensitivity shift of the microphone. The microphone temperature coefficient is shown on its calibration certificate. If an Overall Acoustical Calibration is performed, the 1933 sound-level readings will require no further correction. However, be sure to refer to the calibrator's instructions for temperature corrections, if any, to *its* output.

2.1.1 Internal Electrical Calibration

The internal electrical calibrator checks the overall analyzer with the exception of the microphone, at a frequency of 1 kHz.* Use the dB LEVEL control (lower major control on right side panel) to align the CAL arrows on the MAX MIKE dB control (left side panel). Select the

*The accuracy of the internal calibrator will be ± 0.2 dB in the temperature range between -10° C and $+50^{\circ}$ C.

1-kHz octave band using the BAND control (upper major control on right side panel) and set the SOURCE control (under top cover) to CAL. Press the ON-OFF button*. The meter should read at full scale indicating that the instrument is in calibration and ready for use. If it does not, the reading may be adjusted using the CAL screwdriver control located on the top panel, under the top cover.

2.1.2 Overall Acoustical Calibration Using 1562

The best method of checking calibration is with the 1562 Sound-Level Calibrator, which can check the microphone as well as the electrical circuits at five frequencies.

a. Set the BAND switch (upper knob right side) for the 1 kHz BAND and press the ON/OFF button.

b. Set dB LEVEL control (lower knob right side) for a meter range of 120 dB full scale.

c. Set the frequency of the 1562 Sound-Level Calibrator to 1000 Hz and place it over the microphone on the 1933 using the appropriate coupler adaptor.

d. The meter should read 114 dB ± 0.5 dB. If it does not, adjust the CAL screwdriver control located on the top panel under the top cover until meter reads 114 dB.

e. If desired, check the 1933 meter readings at other frequencies. Select the BAND corresponding to the frequency setting of the 1562. Alternately, the BAND switch can be set to WEIGHTING and the FLAT button depressed. The dB levels observed on the 1933 meter should be within a few tenths of a decibel of the level observed in step d.

*Note: No warm-up time is required beyond that for the meter needle to stabilize.

2.2 AUTOMATIC OPERATION

2.2.1 Selection of Weighting Characteristic

Sound pressure, which is the small variation in atmospheric pressure caused by a sound or noise, is measured in terms of newtons per square meter (N/m^2). Sound pressure is usually expressed as a sound pressure level with respect to a reference sound pressure. The sound-pressure level (SPL) is expressed in decibels and for airborne sounds the reference pressure is 20 micronewtons per square meter ($20\mu N/m^2$). The definition of SPL is:

$$SPL = 20 \log \frac{P}{.000020} \text{ dB re } 20 \mu N/m^2$$

where P is the root-mean-square (rms) sound pressure in N/m^2 for the sound in question. For example, if the sound pressure is $1 N/m^2$ the corresponding sound-pressure level

(SPL) is $20 \log \frac{1}{.00002} = 20 \log 50000 = 94 \text{ dB}$. Whenever

"level" is included in the name of a quantity it can be expected that the value of the quantity will be given in decibels and a reference quantity is stated or implied.

The 1933 is calibrated in decibels relative to $20\mu N/m^2$ as outlined above. When the 1933 is in the FLAT mode, the reading obtained is designated as the "over-all sound-pressure level" or "sound-pressure level" (SPL).

The apparent loudness attributed to a sound varies not only with the sound pressure but also with the frequency (or pitch) of the sound. In addition, the way it varies with frequency depends on the sound pressure. This effect is taken into account by "weighting" networks designated A, B and C. Responses A, B, and C selectively discriminate against low and high frequencies as prescribed in the SOUND LEVEL METER STANDARDS, see Figure 2-1.

Whenever one of these networks is used, the reading obtained is the "sound level" and the weighting used must be specified. For example, the following are appropriate statements: the "A-weighted sound level is 45 dB", "sound level (A) = 45 dB", or SLA = 45 dB." The A-weighted sound level is the one most widely used, regardless of level. A common practice is to assume A-weighting if not otherwise specified.

It is recommended that readings on all noises be taken with all three weightings. The three readings provide some indication of the frequency distribution of the noise. If the level is essentially the same on all three networks, the sound probably predominates in frequencies above 600 Hz. If the level is greater on the C network than on the A and B networks by several decibels, much of the noise is probably below 600 Hz.

Selection of the weighting mode is accomplished by turning the BAND switch knob on the right side panel to the WEIGHTING position and pressing the appropriate A, B, C or Flat button on the front panel.

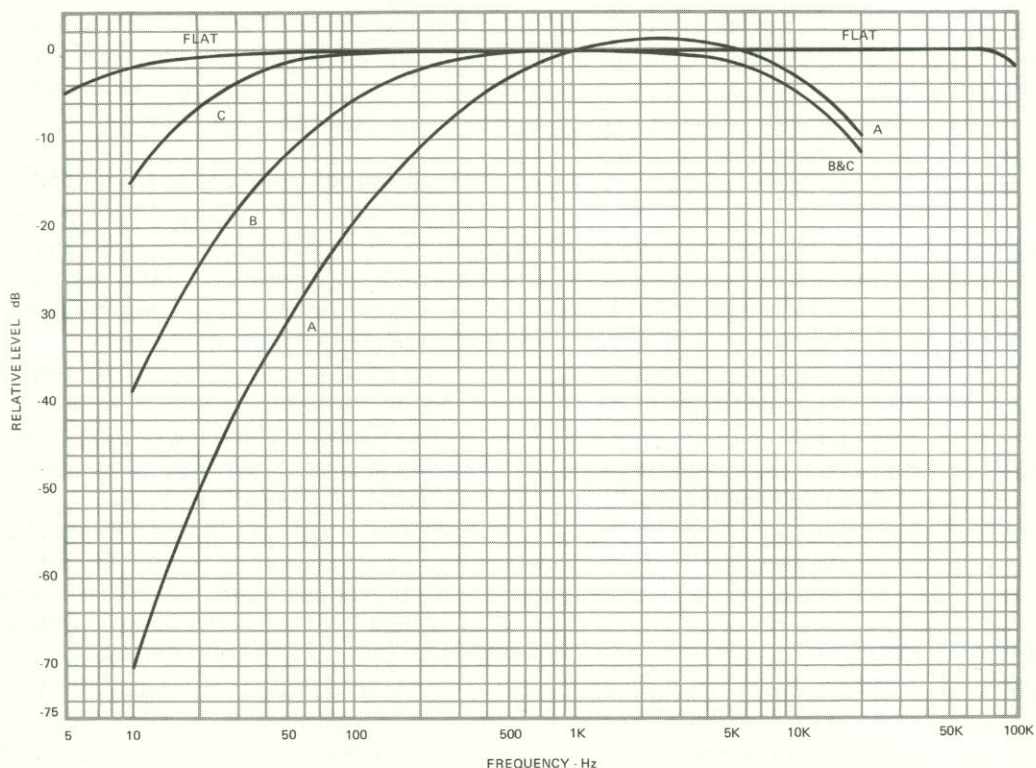

Figure 2-1. Frequency-response characteristics for 1933 SLM, with and without standard weighting networks. Curves exclude the possible acoustical effects of a microphone and are based on a 35-pF-source impedance.

2.2.2 Meter Characteristic

Three meter characteristics (rms, impulse and impact) are available in the 1933. The rms detector has a FAST response and a SLOW response. The impulse detector meets the draft IEC requirements and the impact detector provides a peak measurement.

The FAST rms detector is used for steady or, varying sound levels where meter fluctuations do not exceed 3 dB, or where the detector is required to follow fast changes in level such as in automobile or aircraft pass-by measurements.

The slow rms detector has a longer averaging time characteristic than FAST. The response is approximately that of an RC circuit with a time constant of 0.5 seconds. When the signal is of sufficient duration to allow the meter pointer time to settle or, for a time varying signal, if level does not change too quickly vs time, this characteristic will give a more accurate result than FAST.

The impulse detector is used for impulsive noises such as drop hammers or punch presses. This characteristic is specified in the current draft supplement to IEC Publication 179 and gives a better approximation of subjective loudness for this type signal than does the rms characteristic.

The Peak (Impact) detector is used to measure the absolute peak level of a signal. The measurement of peak level is required by the Walsh-Healey and the Occupational Safety and Health Act.

When both the METER-SLOW and METER-IMP buttons on the front panel are in their normal "out" position, the 1933 has a FAST response. To select SLOW, depress the SLOW button. To select IMPULSE or IMPACT (PEAK) set the slide switch on the right side panel to the appropriate position and depress the IMP button on the front panel. Note that the SLOW and IMP buttons are not interlocked so that one must be released before the other can be depressed.

2.2.3 Extension of Mast and Selection of Microphone Angle

The extendible mast arrangement permits the microphone to be positioned about 12 inches from the instrument case and thus avoids, in most cases, the necessity of using a cable and tripod. To extend the mast, open the top cover, pull the microphone and preamplifier into an upright position and then withdraw the mast. The mast is detented to lock in place when fully extended. The microphone/preamplifier assembly can be set at any angle over an arc of 180°.

CAUTION

Do not attempt to rotate mast. Collapse mast slowly.

When microphones having uniform random incidence response are used the assembly should normally be tilted to about 20° (Figure 2-5). When microphones having uniform

perpendicular incidence response are used, the assembly should normally be set to a 90° position (Figure 2-6). The mast (not the assembly) should then be directed at an angle perpendicular to a line connecting the source and the operator. This angle will produce the least error in frequency response due to the presence of the instrument case and operator in the sound field (see section 2.9).

Indoors, in a reverberant field, a microphone having a uniform random incidence response will produce a more accurate result than a microphone having a uniform perpendicular incidence response. Also, in a reverberant field, there is little to be gained in accurately directing the mast and microphone.

2.2.4 Making an Octave Band Analysis

The 1933 has ten octave band filters with center frequencies ranging from 31.5 Hz to 16 kHz. The magnitude and phase response characteristics of the filters are shown in Figures 2.2 and 2.3.

Measuring octave-band levels with the 1933 is as simple as measuring sound-level. The "opti-ranging" system operates to ensure that the analyzer is never overloaded, and it is unnecessary to make a FLAT ("all pass") measurement before making the octave-band analysis.

Simply select an octave band center frequency with the BAND control (upper control on right side of case), adjust the dB LEVEL control (lower control on right side of case) for an on-scale meter deflection and read the meter. The response is unaffected by weighting button position.

2.3 OVERLOAD INDICATOR

When the OVERLOAD lamp is lit (lower right corner of meter), meter readings are invalid. The purpose of this lamp is to warn the operator when any of the circuits in the analyzer have been overloaded and also when the MANUAL OVERRIDE control has been used incorrectly.

It should be realized that a sound-level meter that does not have an overload detection system may produce a meter indication that appears normal but is invalid because of overload. This problem arises with impact sounds that have very high peak-to-rms ratios (crest factor) such as those produced by typewriters and key punches. The 1933 is especially suitable for such difficult measurements because it has a crest factor capacity of 20 dB at full scale on the meter (proportionately higher below full scale) in addition to the overload detection system.

The overload lamp will light when the peak level of the signal at any stage is high enough to overload that stage. In addition when the analyzer is used in its manual mode, it will also light if the main level range control is set to give a full scale range higher than, or more than 50 dB lower than, that indicated by the MANUAL OVERRIDE control.

When the analyzer is being used in its normal automatic mode, set the level range control to a higher (in dB) range

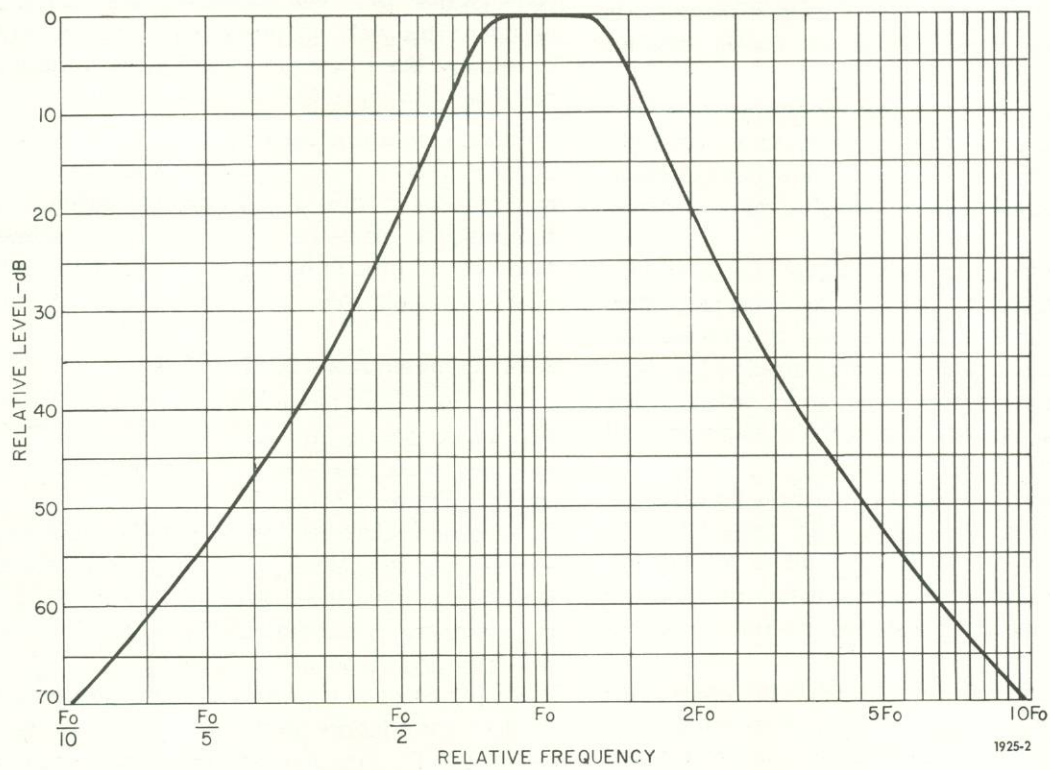

Figure 2-2. Normalized magnitude response of the octave-band filter in the 1933.

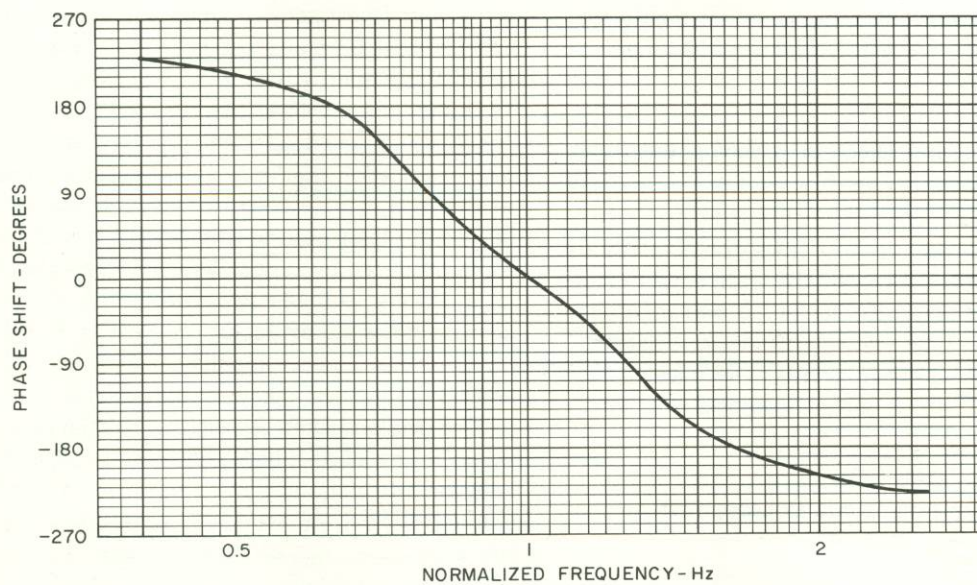

Figure 2-3. Normalized phase response of the octave-band filter in the 1933.

when an OVERLOAD is indicated. In the manual mode, check to be certain that the main level range is within the acceptable range as stated above. If it is, then an OVERLOAD exists which can be eliminated by setting either the MANUAL OVERRIDE control or the main level range control to a higher range.

2.4 CHECKING AND CHANGING BATTERIES

Rated accuracy can be maintained only if the batteries supply more than a certain minimum voltage. This voltage is indicated by the meter in the BAT CHECK mode. Therefore, the batteries should be checked before checking calibration or making measurements. With the instrument ON, press the BAT CHECK button and observe that the meter indicates above the battery mark. If not, slide off the battery cover on the bottom panel and replace the batteries being careful to observe polarity. Use alkaline energizer C cells (4 required), Burgess AL1, Eveready E93, Mallory Mn 1400 or equivalent. Alkaline energizers will provide about 20 hours continuous operation. Ordinary flashlight batteries may also be used. The operating time however will be substantially less.

NOTE

Observe the usual precautions against the formation of ground loops when using external equipment.

2.5 SIGNAL OUT AC JACK

This jack allows the 1933 to be used as a preamplifier for a magnetic tape recorder, a graphic level recorder or other devices. It may also be used for driving earphones. This signal is taken from the output of the analyzing amplifier/attenuator ahead of the detector. It is an ampli-

fied replica of the input signal with the weighting set to FLAT or of the weighted or filtered signal otherwise. The rms value of the output (open circuit) voltage corresponding to a full scale indication on the meter is 0.5 volts. The source impedance is 600 ohms and any load can be connected without affecting the meter reading or linear operation of the output circuits.

2.6 METER OUT (DC) JACK

This jack is intended primarily to provide a detected (DC) signal, linear in decibels for driving a DC recorder. The recorder can be used to display the Fast, Slow, Impulse or Peak sound level as a function of time or octave band pressure levels as a function of frequency. Details of connection and use of a DC recorder are given in section 2.19. The DC signal available at the METER OUT (DC) jack can also be used to drive a meter to provide a wide dynamic range display or to trigger an alarm.

The signal at this jack is 4.5 V behind a resistance of 4.5 k Ω corresponding to full scale on the meter. Each 0.1 volt change in open circuit voltage corresponds to a 1 dB change in level (i.e., the sensitivity is 0.1 V/dB). The useable range in open circuit output voltage is 6.5 volts to 0.5 volts or a linear-decibel range of 60 dB. Any load resistance can be connected. If the output is short circuited, it produces a current of 1 ma at full scale on the meter.

Figure 2.4 shows the sine wave frequency response of the 1933 measured at the Meter Out (DC) jack at six different levels on the 110 dB range. The response is plotted for all four meter detector characteristics; FAST, SLOW, IMPULSE and PEAK and includes the low frequency coupling effect of the 1962 microphone.

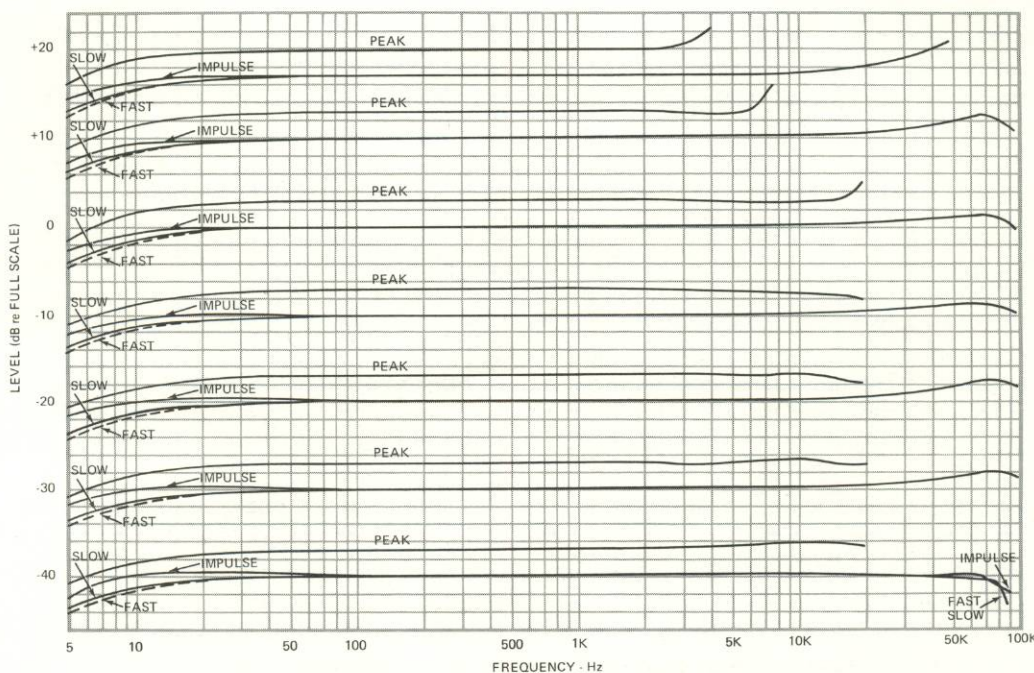

Figure 2.4. Comparative frequency responses of PEAK, IMPULSE, FAST and SLOW measurement modes of the 1933. Readings all taken at METER OUT (DC) jack.

2.7 USE OF FILTER JACKS

The two miniature phone jacks (closed circuit type) on the left side panel, marked TO EXT FILTER and FROM EXT FILTER can be used to substitute an external filter or weighting network for the internal ones.

To use the jacks, set the BAND control to WEIGHTING and push the FLAT (or ext) button on the front panel. The internal signal path is now through the phone jacks and will be broken by inserting the phone plugs that connect the external filter.

The output impedance at the TO EXT FILTER jack is less than 50Ω and the filter connected must have an input impedance of 600Ω or more. The input impedance at the FROM EXT FILTER jack is $60 \text{ k}\Omega$ and the filter connected must not have an output impedance of more than $6 \text{ k}\Omega$. The maximum voltage (open circuit) at the TO EXT FILTER jack is about 1 volt peak so that the external filter should be capable of handling this signal level if the full 20 dB crest factor capacity of the analyzer is to be realized.

2.8 CHANGING MICROPHONES

Because no single microphone is best for all applications, the analyzer includes a SOURCE control that allows selection of two preset gains. These gains are adjusted at the factory to accommodate the microphones supplied with the analyzer. It is therefore not necessary to recalibrate the analyzer when changing microphones.

When the analyzer is supplied with only a 1/2 inch electret condenser microphone (1933-9701 and 1933-9703), the gain presets are adjusted to accommodate both the microphone cartridge and the microphone cartridge with the 10 dB attenuator (supplied) in place. When the analyzer is supplied with both 1/2 inch and 1 inch electret condenser microphones, the gain presets are adjusted to accommodate the two microphone cartridges only. The analyzer is not calibrated for use with the 10 dB Attenuator.

To change gain to accommodate microphones supplied with the analyzer, it is only necessary to reset the SOURCE control (under top cover) and adjust the MAX MIKE dB control according to the block checked in the chart inside the top cover. Push in the knurled MAX MIKE dB control (left side panel) and turn it to the position indicated by the chart. The proper setting is given adjacent to the serial number of the microphone being used. (The serial number is marked on the ring which is visible inside the threaded end of the microphone. When the 10 dB attenuator is used, its serial number governs.)

The gain presets, R9 for MIKE A and R7 for MIKE B, may be set to accommodate other microphones (not supplied) or the 1/2" electret condenser microphone with the 10 dB attenuator. Proceed as follows:

Install the microphone on the 1933 preamplifier.

Remove the back cover from the Analyzer to expose the preset controls (see para. 4.4).

2-6 OPERATION

Table 2-1
GAIN PRESET ADJUSTMENTS
MICROPHONE SENSITIVITY

Microphone Sensitivity		Setting of MAX MIKE dB Control
Level dB re 1 V/N/m ²	Level dB re 1 V/ μ bar	
-26 to -36	-46 to -56	120
-36 to -46	-56 to -66	130
-46 to -56	-66 to -76	140
-56 to -66	-76 to -86	150

Set the SOURCE control to the position desired for the new microphone.

Set the MAX MIKE dB control to the position indicated in Table 2-1 for the sensitivity level of the new microphone. Press in and then turn the knurled knob. Place the Type 1562 Calibrator set at 1 kHz over the microphone. Set the BAND control to WEIGHTING and the dB LEVEL control for the 120 dB (full scale) range. Depress the C button and adjust the appropriate gain preset control for a meter indication of 114 dB.

2.9 PROXIMITY EFFECTS OF CASE AND OBSERVER.

Every effort has been made to make the 1933 a self-contained precision sound-measuring instrument. The extendible mast and swivel mounting for the microphone and preamplifier make it possible to avoid in most cases the necessity of using an extension cable and tripod to remove the microphone from proximity to the instrument case and observer. To achieve most accurate results, always, where practical, follow these simple rules:

1. Extend the mast to its full length, where it will lock in position.

2. Stand so the sound source is to your left.

3. When using a random incidence microphone (supplied with 1933-9700, -9701) set the preamplifier to 20° . When using a perpendicular incidence microphone, set the preamplifier to 90° . Hold the microphone away from yourself and other large objects and direct the mast (not the microphone) at an angle perpendicular to a line connecting you and the sound source. Figures 2.5 and 2.6 show the small error that may be introduced by the presence of the instrument case and observer when these rules are followed. Error curves are given for the 20° preamplifier position and for the 90° preamplifier position both with and without the operators presence.

Figure 2.7 shows the error introduced by the instrument case (no operator present) when the preamplifier is in its 0° position and the mast is pointed at the source. This position should be avoided if possible.

All error curves were obtained using pure tones in a free-field (anechoic space) and can be considered "worst case". For normal industrial or community noise environ-

ments, or indoors, error will be considerably smaller and can be ignored.

The 10 ft cable supplied with the 1933 (1933-9600) or the 60 ft cable available (1933-9601) can be used to allow both operator and instrument case to be positioned still farther from the microphone, thus eliminating the proximity errors. The microphone preamplifier is then mounted on the 1560-9590 tripod or by other means.

2.10 EXTENSION CABLES

A ten foot extension cable 1933-9600 is supplied with the Sound-Level Meter and Analyzer. In addition, a sixty foot extension cable 1933-9601 is supplied with the

Sound-Analysis Systems 1933-9710, -9711, -9712, and -9713 or it may be ordered separately.

Cables are inserted between the removable preamplifier and the mast. Because the preamplifier and not the microphone drives the cable, there is no loss or change in calibration when a cable is used. To install a cable, remove the preamplifier by depressing the connector latch (small button visible through hole at connector end of preamplifier) with a pencil or other pointed object and pulling the preamplifier straight out.

Still longer cables can be used at reduced levels and frequencies. The length depends upon the capacitance of the cable used. Approximately 1 mA peak is available from the preamplifier for driving a cable.

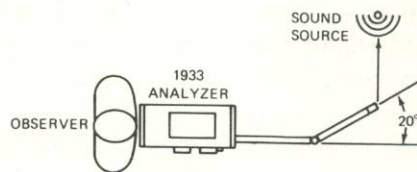
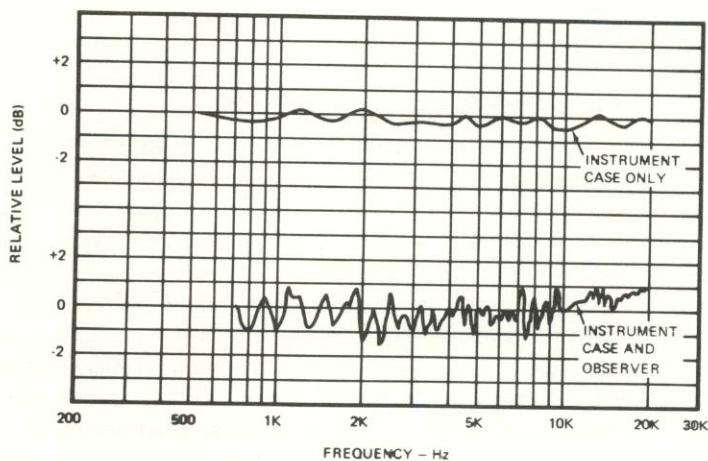

Figure 2-5. Error introduced by presence of instrument case and observer in sound field, with preamplifier at 20°.

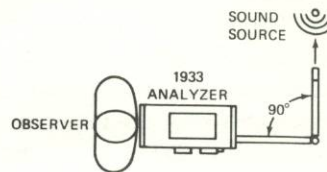
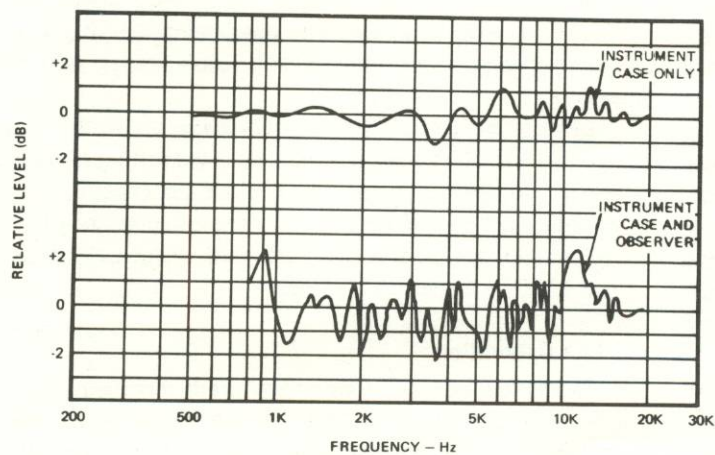

Figure 2-6. Error introduced by presence of instrument case and observer in sound field, with preamplifier at 90°.

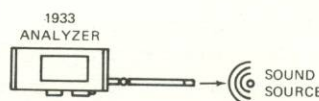
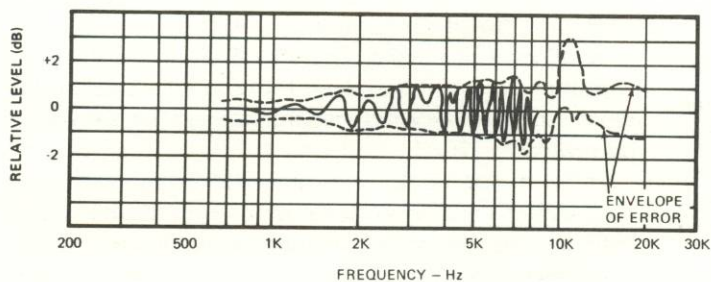

Figure 2-7. Error vs frequency introduced by instrument case alone in sound field, with preamplifier at 0°.

2.11 USE OF MANUAL OVERRIDE CONTROL

In some cases, for example, when measuring a transient signal (one available for measurement for only a few seconds) whose band levels are known approximately, it may be desirable to override the automatic system and manually set the gain of the amplifier/attenuator circuits to save the 4-second settling time. A MANUAL OVERRIDE control, used with the dB LEVEL control, provides standard manual operation for the occasion when the automatic system is not appropriate.

When used in the automatic (AUTO) mode, provided the OVERLOAD lamp is not lit, the 1933 will produce a valid meter indication even during the 4-second settling time. However, during this period the dynamic range of the signal at the SIGNAL OUT AC jack (and signal at DATA OUTPUT connector) will generally not be as high as after the settling interval. Given some knowledge of the expected overall level of a transient signal, the settling interval can be avoided by use of the MANUAL OVERRIDE control. For normal operation, this control is set to AUTO(max ccw).

For manual operation the control functions in exactly the same way as the input "attenuator" control on a manual analyzer. It is set in accordance with the expected maximum overall (i.e. C-weighted or FLAT) level of the input signal. Set the MANUAL OVERRIDE control to indicate a full-scale level for the overall signal that is as high as or higher than the maximum overall level expected in the transient signal.* (In some cases, it may be possible to measure the overall (C-weighted or Flat) level of a test signal in order to establish the correct setting of the MANUAL OVERRIDE control.) Now select the weighting network or filter band desired and adjust only the dB LEVEL control for a meter full scale range that is at least as high or higher than the maximum level expected in the selected band. Obviously, the dB LEVEL control must not be set to a full scale range higher than the full scale range indicated on the MANUAL OVERRIDE control. Also, the dB LEVEL control cannot usually be set to a full scale range more than 50 dB below that indicated by the MANUAL OVERRIDE control. (An exception is when the input signal has a low to moderate crest factor such as, for example, a square wave or sine wave signal).

If either the allowed maximum or minimum settings of the dB LEVEL control are exceeded, the panel OVERLOAD lamp will light to warn the operator.

2.12 USE OF SOURCE CONTROL

The SOURCE control provides a means for conveniently using the Sound-Level Meter and Analyzer with several sources including two microphones, the 1935 Cassette Data Recorder and possibly an accelerometer. The MIKE positions A and B normally select preset gains corresponding to those required for two microphones. In the TAPE position,

*Its MAX dB value should be set at the colored dot corresponding to the dot adjacent to the microphone check block in the top cover.

the 1933 has a sensitivity of 0.5 V full scale when the dB LEVEL control is in its max cw position (least sensitive meter range). CAL activates the internal calibration system.

2.13 DATA OUT CONNECTOR

This is a nine-pin miniature connector located on the left side panel of the 1933. It is used for interconnection with the 1935 Cassette Data Recorder. When not in use it is capped. Connection to the Data Recorder is by means of the coiled data cable 1935-9630 which has a mating nine-pin connector on one end and a fourteen-pin connector on the other. Secure both connectors using the thumb screws. This cable completes all connections needed between the 1933 and 1935 Cassette Data Recorder. Consult the 1935 Instruction Manual for more information on the use of this combination.

2.14 USE WITH ACCELEROMETERS

The 1933 can be used for vibration measurements when the microphone is replaced with an accelerometer. Three accelerometers are available. They are Types 1560-P52, -P53, and -P54. The -P52 is a general-purpose, low-cost unit with moderate high-frequency performance, the 1560-P53 has a wide frequency range and should be used when frequencies above about 1500 Hz must be measured, the 1560-P54 is a high sensitivity pickup used to measure very low acceleration levels. Table 2-2 lists the performance characteristics of these pickups when used with the 1933.

A type 1560-9669 adaptor is required to connect the cable supplied with the pickups to the 1933 preamplifier input. The adaptor screws onto the preamplifier in place of the microphone and the pickup cable plugs into the adaptor.

Because the dB LEVEL drum *indicator* on the 1933 can be set in any of its positions relative to the setting of the dB LEVEL *control* using the MIKE MAX dB control, it is a simple matter to calibrate the 1933 to be direct reading in decibels referred to the ANSI standard preferred reference level of 10^{-3} cm/sec² (S1.8-1969).

2.14.1 Calibration

The following calibration procedure is recommended to make the 1933 direct reading in dB re 10^{-3} cm/sec²; other methods can also be used. The procedure requires use of a Type 1557 Vibration Calibrator which generates a reference level of 1 g rms at a frequency of 100 Hz.

a. When using either the 1560-P52 or the 1560-P53 accelerometers, set the MAX MIKE dB control to 140. When using the 1560-P54 accelerometer set the MAX MIKE dB control to 120.

b. Set the dB LEVEL control for 120 dB full scale.

c. Mount the accelerometer on the Type 1557 Vibration Calibrator and adjust the calibrator to produce a level of 1 g rms. (See instruction manual supplied with the calibrator.)

Table 2-2
ACCELEROMETER PERFORMANCE CHARACTERISTICS†

Pickup Type No.	Nominal Sens. mv/g	Resonant Freq. Hz	Frequency Range Hz	Acceleration Range*		dB re* 10 ⁻³ cm/sec ²
				g	in/sec ²	
1560-P52	70	3200	5 – 1600	8x10 ⁻⁶ to 7	.0036-2700	20-140
1560-P53	70	27000	5 – 14000	8x10 ⁻⁶ to 7	.0036-2700	20-140
1560-P54	700	5000	5 – 2500	8x10 ⁻⁷ to 0.7	.00036-270	0-120

*Minimum levels measurable only in middle frequency octave bands.

†See also Table 2-4.

d. Set the 1933 to WEIGHTING and FLAT and turn it ON.

e. Set the SOURCE control to preset A or B as desired and adjust the appropriate gain preset (R9 for A, R7 for B) for a meter indication of 119.8 dB. R9 and R7 are found under the back cover. See para. 4.4 for removal of cover.

2.14.2 Operation

The instruction sheet supplied with the accelerometer provides specifications and explains how it should be fastened. Disregard instructions on use of the overall pick-up system including the control box. The low frequency limit, when any of the above accelerometers are used, is determined by the 1933. That is, with the FLAT weighting, the system (including the accelerometer) will respond uniformly down to about 5 Hz. The upper frequency limit is determined by the resonant frequency of the accelerometer. It is usually taken to be about one-half of the resonant frequency of the accelerometer and is given in Table 2-2.

2.15 ENVIRONMENTAL EFFECTS

2.15.1 Background Noise

Ideally, when a noise source is measured, the measurement should determine only the direct air-borne sound from the source with no appreciable contribution from noise produced by other sources. This criterion is met practically when the background noise is 10 dB or more below the sound being measured. If the background noise is not 10 dB below the sound being measured in any given band, a correction can be applied to the total noise reading as determined by Figure 2-8.

Take readings with the Sound-Level Meter and Analyzer at the test position with and without the sound source, to be measured, operating. The difference in readings determines the correction to be used. For example, if an octave band level reading with the sound source off (background level) is 77 dB and with the sound source on is 83 dB, the difference is 6 dB and the correction from the curve of Figure 2-8 is 1.2 dB so the corrected octave band level is 81.8 dB. The correction must be determined for each octave band or weighting characteristic of interest.

2.15.2 Precautions at Low Sound Levels

When making low-level noise measurements with the microphone mounted on the 1933 mast a sound is

transmitted to the microphone when the meter pointer strikes the lower meter stop. This sound can cause the meter pointer to read up scale again and if the instrument is set to METER FAST, a sustained oscillation can occur. To avoid this condition use the SLOW meter response or mount the microphone and preamplifier away from the Sound-Level Meter and Analyzer using the extension cable supplied.

Another feed-back effect may occur when an earphone is connected to the AC OUTPUT. The feedback path is closed through the path between the earphone and the microphone causing the earphone to "howl". The solution to this problem is to separate the earphone and microphone as much as possible. In extreme cases, it may be necessary to use the preamplifier extension cable supplied.

Wind Effects. When the microphone is used in wind, a low frequency noise is generated by turbulence caused when the wind passes around the microphone. The level of this noise may be high enough to obscure the sound to be measured and in some cases, to overload the analyzer. This noise can be greatly reduced by using a wind screen. It is good practice to use a wind screen whenever making noise measurements out of doors.

The GR wind screens will reduce wind-generated noise by about 20 dB, for winds up to 25 mph, with no serious

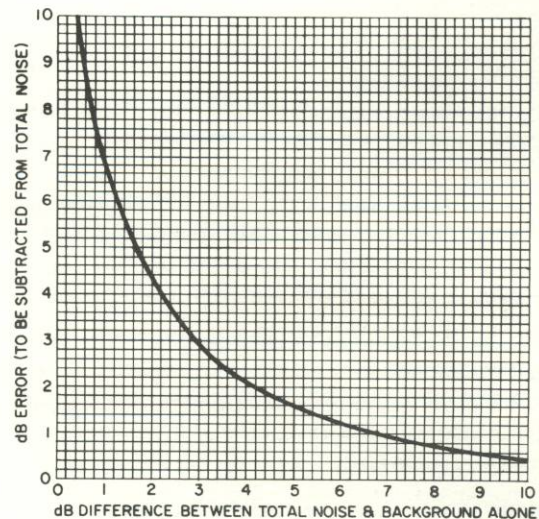

Figure 2-8. Background noise correction for sound measurements.

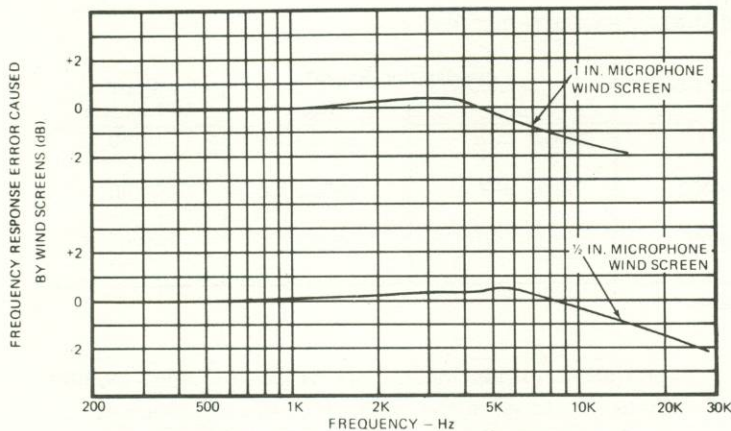

Figure 2-9. Effect of windscreens on microphone response.

effect on frequency response. There is a slight loss of frequency response at high frequency as shown in figure 2-9. Since wind noise is concentrated at low frequencies, using A-weighting to attenuate the noise may help. Also, the octave bands above 500 Hz are less effected by wind noise than those below.

2.15.3 Hum Pickup (Magnetic Fields)

The maximum sensitivity of the 1933 to an external magnetic field is equivalent to 43 dB(C) when the applied field is 80 A/m at 60 Hz. Hum pickup is not normally a problem with the 1933. However, when making measurements near heavy electrical equipment, a check may be made to see that there is no appreciable pickup of the magnetic field. To make this check, replace the microphone with the 1560-P9 dummy microphone or other shielded capacitor that has the same capacitance as the microphone being used. With the dummy microphone installed, the equivalent sound level due to hum should be 10 dB or more lower than the sound level to be measured. Changing the orientation of the instrument may help.

2.15.4 High Sound Levels (Microphonics)

At very high sound levels, components or wiring in a sound-level meter may vibrate and thereby produce an interfering noise. The instrument is then said to be generating microphonics.

To test for microphonics, replace the microphone with a 1560-P9 dummy microphone and observe whether the indicated level is less than the level with the microphone connected. If the level in the band (or with the weighting) to be used is not at least 10 dB below the level with the microphone connected, use a 10' or 60' preamplifier extension cable to allow the instrument to be removed from the high sound-level area.

2.15.5 Vibration

The vibration sensitivity of the 1933 is primarily that of the microphone, which is an equivalent maximum level of 83 dB for 1 g vibration.

2.16 INTERNALLY GENERATED NOISE.

The dynamic range (full scale to noise floor) of the

instrument is a function of the setting of the dB LEVEL control. The noise charts in para. 4.5 show typical internally generated noise levels in dB below full scale for each settings of the dB LEVEL control when the instrument is set to C weighting as measured at the SIGNAL OUT AC jack by another octave band analyzer. The dynamic range is also a function of the capacitance of the microphone and therefore, charts are shown for the 1" and 1/2" electret condenser microphones and the 1" and 1/2" ceramic microphones. All charts apply for the typical microphone sensitivity as given.

The lowest level that can be measured with a sound level meter is usually taken to be a level 5 dB above the absolute noise floor of the instrument. Table 2-3 gives minimum levels according to this criterion for A, B and C weighting, FLAT and octave bands and for all four normally used microphones.

The internal noise levels of para. 4.5 and those used here to determine the minimum measureable noise level are for a typical instrument, the actual noise floor of any given instrument can be determined by replacing the microphone with a dummy source having a capacitance equal to that of the microphone. The 1560-P9 Dummy Microphone has a capacitance of 35 pf and is thus suitable as a dummy source, replacing the 1/2" electret condenser microphone. The 1" electret condenser microphone should be replaced with a source capacitance of 125 pf and the 1" or 1/2" ceramic microphone should be replaced with a source capacitance of about 400 pf.

2.17 USE OF ACCESSORIES

A number of accessories are available for the Sound-Level Meter and Analyzer and the various Sound-Analysis Systems. The purpose of each is described in the following.

The mini-phone plugs (4270-1110) are used to make connection to the SIGNAL OUT AC jack, the METER OUT DC jack, or the FILTER jacks.

The screwdriver is for adjustment of the CAL control located in the top panel of the instrument or for adjustment of the internal "preset" controls.

The 1933-9600 and -9601 (10 ft. and 60 ft.) Extension Cables are for use between the microphone/preamplifier combination and the input connector on the mast of the 1933. They allow the microphone to be positioned remotely from the instrument case and operator.

The MINE LABEL (1933-0150) is a self-adhesive label stating that the 1933 has been approved for use by the U.S. Bureau of Mines. It should be attached to the instrument as instructed in the protective instruction folder by those who intend to use the instrument where the Bureau of Mines approval is required.

The Dummy Microphone (1560-P9) is simply a capacitor which simulates the capacitance of the 1/2 inch electret condenser microphone. It is used with the shorting cap in place to measure internal noise level. The shorting cap can be removed to allow an electrical signal simulating the

microphone source to be applied to the analyzer for testing and calibration. When connected to the 1933 the loss in signal through the dummy mike is about 0.5 dB.

The Sound-Level Calibrator (1562) is used to make an overall (including the microphone) calibration check on the analyzer. It is provided with adaptors to fit the 1 inch and 1/2 inch microphones and generates a sound-pressure level of 114 dB at five frequencies from 125 to 2000 Hz.

The earphone (1935-0410), a small in-the-ear type earphone, is used to listen to the sound being measured at the SIGNAL OUT AC jack. It is helpful in determining the nature or source of a noise and providing assurance that the analyzer is operating properly.

The tripod (1560-9590), a compact unit with elevating center post, is used to support the microphone and pre-amplifier when they are used at the end of an extension cable. It can also be used to support the complete 1933. The tripod has a swivel head that permits 0 to 90° adjustment in one direction and 0 to 20° (for proper orientation of a microphone with flat random incidence response) in the other direction. The head has two concentric removable sleeves for mounting 3/4 inch diameter devices or 1/2 inch diameter preamplifiers. It also has a standard 1/4-20 screw and a locking nut for mounting the 1933. The friction in the swivel can be adjusted by removing the swivel from the center post of the tripod and adjusting the allen head screw in the base of the swivel.

The Microphone Attenuator (1962-3200) is a 10 dB capacitive attenuator to be used with the 1962-9601 or 9602 1/2 inch electret condenser microphones when sound levels above 130 dB are to be measured. This unit is inserted between the 1/2 inch microphone and the pre-amplifier input.

The Cassette Data Recorder (1935) is a major accessory for the 1933 and is supplied with many of its accessories in the 1933-9712, 9713 Sound-Analysis Systems. Instructions for the recorder and its accessories are given in the operating instruction book for the 1935.

1933-9602 miniature phone plug to 1933 mast connector is used to connect the output of the 1935 Cassette Data Recorder to the input of the 1933. It is supplied with the 1935 Cassette Data Recorder. This cable can also be used to connect the 1560-P62 Power Supply to the input of the 1933 thus allowing the 1560-P42 Preamplifier to be substituted for the 1933 Preamplifier. The 1560-P42 is used for driving very long input cables.

1560-9677, miniature phone plug to double banana plug, used to connect METER OUT DC, SIGNAL OUT AC, or FILTER jacks of 1933 to instruments with GR (or equivalent) binding post terminals.

1560-9678, miniature phone plug to standard phone plug, used to connect jacks on 1933 to instruments with standard phone jacks.

1560-9679 miniature phone plug to BNC connector used to connect jacks on 1933 to instruments fitted with BNC connectors.

1560-9680, miniature phone plug to standard phone jack adapts miniature phone jacks on 1933 to connect with standard phone patch cords. Can be used to connect SIGNAL OUT AC jack of 1933 to 1556 Impact Noise Analyzer.

1560-9675, miniature phone plug to special double banana plug with molded-in 200 Ω resistor, used to connect METER OUT DC jack of 1933 to input of Simpson 2745 DC recorder.

0776-9701, shielded double banana plug to BNC connector, used to connect output of GR oscillators and/or attenuators to input of 1933 through 1560-P9 dummy microphone.

2.18 1940 POWER SUPPLY AND CHARGER.

The 1940 Power Supply and Charger permits the 1933 Precision Sound-Level Meter and Analyzer to be operated directly from the power line and also permits use of rechargeable batteries. There is no change in accuracy when the 1940 power supply is used. The 1940 is supplied with rechargeable batteries which are used to replace the alkaline

Table 2-3
TYPICAL MINIMUM MEASUREABLE NOISE LEVELS (dB re 20 μN/m²)

Microphone Type	Typical Sensitivity Level dB re 1 V/N/m ²	Octave-Band													
		A	B	C	FLAT	31.5	63	125	250	500	1K	2K	4K	8K	16K
1-in Electret Condenser	-37	22	21	22	32	18	16	14	13	11	11	13	15	17	19
½-in. Electret Condenser	-43 *	31	32	36	42	32	30	28	26	25	23	24	24	24	26
		34	35	39	45										
1-in Ceramic	-40	24	22	23	34	16	13	12	11	11	13	14	16	18	21
½-in Ceramic	-62	46	44	45	56	38	35	34	33	33	35	36	38	40	43

* Guaranteed minimum measurable levels with ½-in. electret-condenser microphone.

energizers supplied with the 1933. If the 1940 is to be used to provide only power line operation, it is unnecessary to install the rechargeable batteries.

CAUTION

Do not use the 1940 when alkaline energizers are in the 1933.

Five recessed jacks on the bottom of the 1933 accept plugs on the 1940; fully plug the instruments together. The 1940 also serves as a convenient bench stand.

To power the 1933 from the 1940 supply, connect the 1940 power cord to a power line and set the BATTERY/PWR LINE switch to PWR LINE. The PWR LINE lamp will light when the supply is connected to the power line. Now, simply operate the 1933 in the normal way. While operating on PWR LINE, the batteries will be charged by an independent charging supply. The BATTERY CHARGED light will come on to indicate that the batteries are fully charged and are being maintained in that condition by "trickle" charging.

To charge the batteries only, proceed as above but do not turn on the 1933.

The 1933 may be operated from its batteries when mounted on the 1940 by setting the BATTERY/PWR LINE switch on the 1940 to BATTERY.

One important feature of the 1940 Power Supply and Charger is that line power may be connected and disconnected by external means. When power is disconnected, the 1933 will cease to operate and will not drain its batteries.

2.19 USING A D.C. RECORDER

The METER OUT DC jack provides a DC signal linear in decibels for driving a DC recorder. A DC recorder for use with a portable system such as the 1933 should be small, lightweight, and battery operated. In addition, it should have fast writing speed and a range of chart speeds so records of sound levels versus time and octave band levels vs frequency can be made. The Simpson Model 2745 X-Y Recorder is such a portable battery operated DC recorder. Its writing speed is 20 cm/sec. (.5 sec for full scale), fast enough to follow accurately the METER OUT DC voltage from the 1933 in the METER SLOW position and fairly well even with a fluctuating signal in the FAST and IMPULSE positions.

The following procedure is recommended to set up the level recorder to cover a 50-dB range with a scale sensitivity of 5 dB/cm.

1. Connect the Y INPUT of the recorder to the METER OUT-DC jack of the 1933 using a 1560-9675 cable. This cable has a 200 Ω resistor molded in and a plug that fits the input terminals of the Simpson recorder. The 200 Ω resistor shunts the output of the analyzer to produce a lower voltage compatible with the recorder.

2. Select a recorder sensitivity of 50 mV/cm.

3. Set the zero adjust on the recorder for zero pen deflection when the 1933 is turned off.

4. Set the 1933 in its CAL mode with the meter indicating at full scale and adjust the sensitivity of the recorder for a pen deflection to 90% of full scale (90 divisions when chart paper having 100 divisions is used).

5. Now adjust the recorder zero control for a pen deflection to 80% of full scale (80 divisions).

The recorder is now adjusted to produce a 50 dB range plot. It will deflect to 40 dB (80% of full scale) when the 1933 is at full scale and to 50 dB when the 1933 is 10 dB above full scale. The crest factor allowance when the recorder is at full scale is thus, 10 dB.

Other recorders with similar sensitivity and writing speed to the Simpson 2745 such as the MFE M-12 recorder can also be used. This recorder is AC operated and has a single chart speed.

GR Type 1522 DC Recorder

The 1522 DC Recorder using the 1522-P1 Preamp is suitable for use with the 1933. Zero the recorder and connect the METER OUT DC jack of the 1933 to the 1522-P1 input with a 1560-9677 (miniature phone plug to double banana plug) cable. Set the full scale range of the recorder to 5 V. With the 1933 in the CAL mode (reading full scale) adjust the recorder deflection to 90% of full scale (90 division when 100 division chart paper is used). Reset the recorder zero adjust for an 80% deflection. The 5 inch chart should now cover a 50 dB range (10 dB/inch) corresponding to 1933 levels ranging from 10 dB above full scale (5.5 volts) to 20 dB below bottom scale (0.5 volts). The crest factor allowance of the system with the recorder at full scale is thus 10 dB.

2.20 USING THE SOUND-LEVEL METER AS A PREAMP.

Its wide frequency range (5 Hz to 100 kHz), wide dynamic range, high level output signal and low distortion make the 1933 ideal as a preamplifier for use in driving signal analyzers, level recorder and magnetic tape recorders directly or through long interconnecting cables.

When it is used as a preamplifier, weighting is normally set to FLAT or, C if the signal is in the frequency range between 32 and 8 kHz. Set the MANUAL OVERRIDE control to AUTO unless the signal is of short duration (see paragraph 2.11). Connect the device to be driven to the SIGNAL OUT AC jack using a miniature phone plug or the appropriate adaptor cable (see paragraph 1.5 accessories available).

For maximum signal-to-noise ratio in the output signal, adjust the dB LEVEL control so the maximum signal level drives the meter into the top half of its range. The meter can be used to continuously monitor the level of the signal being amplified or set to monitor the batteries (BAT CHECK). When the meter is used to monitor the batteries, the OVERLOAD lamp will continue to provide a warning when overload occurs. The 600 Ω output is DC coupled and will deliver an undistorted signal to any linear load impedance.

2-12 OPERATION

Table 2-4

DECIBELS TO RMS ACCELERATION IN CM/SEC ²								
Pickup	-P54		-P52/-P53/-P54				-P52/-P53	
Multiplier	.01	0.1	1.0	10	10 ²	10 ³	10 ⁴	Ratio Value
1933 Indications	dB	21 dB	41 dB	61 dB	81 dB	101 dB	121 dB	.1122
		22	42	62	82	102	122	.1259
		23	43	63	83	103	123	.1413
		24	44	64	84	104	124	.1585
		25	45	65	85	105	125	.1778
		26	46	66	86	106	126	.1995
		27	47	67	87	107	127	.2239
		28	48	68	88	108	128	.2512
		29	49	69	89	109	129	.2818
	10	30	50	70	90	110	130	.3162
	11	31	51	71	91	111	131	.3548
	12	32	52	72	92	112	132	.3981
	13	33	53	73	93	113	133	.4467
	14	34	54	74	94	114	134	.5012
	15	35	55	75	95	115	135	.5623
	16	36	56	76	96	116	136	.6310
	17	37	57	77	97	117	137	.7079
	18	38	58	78	98	118	138	.7943
	19	39	59	79	99	119	139	.8913
	20	40	60	80	100	120	140	1.000

Multiply the Ratio Value by the Multiplier above the dB column. For example:
For a 65-dB reading, it is 0.1778 x 10 = 1.778 cm/Sec².

Theory—Section 3

3.1 GENERAL	3-1
3.2 MICROPHONE SYSTEM	3-1
3.3 OPTIRANGE SYSTEM	3-1
3.4 DETECTOR SYSTEM	3-4
3.5 FILTERS AND WEIGHTING NETWORK	3-4
3.6 POWER	3-4
3.7 BLOCK DIAGRAM	3-5

3.1 GENERAL

As its name indicates the 1933 is both a sound-level meter and a spectrum analyzer. It includes the sound level weighting networks A, B, and C, an octave-band filter that is tunable to the 10 standard center frequencies from 31.5 Hz to 16 kHz and a flat or "all pass" characteristic that extends in frequency from 5 Hz to 100 kHz.

3.2 MICROPHONE SYSTEM

The analyzer uses an extendible mast arrangement that permits the microphone to be positioned more than 12 in. from the instrument case and thus avoids in most cases the necessity of using a cable and tripod for precision work. When a cable extension is needed, the preamplifier is unplugged along with the microphone allowing the cable to be inserted between the preamplifier and instrument.

Because no single microphone is best for all purposes, the analyzer is normally equipped with both 1-in. and 1/2-in. diameter microphones. The 1/2-in. microphone is preferred for smoothest and widest frequency response at moderate and high sound-pressure levels, while the 1-in. microphone is used when greatest sensitivity and signal-to-

noise ratio is needed. The analyzer is supplied equipped with either "flat random incidence" response microphones (P/N 1961-3000 1-in. diameter and P/N 1962-3000 1/2-in. diameter) or "flat perpendicular incidence" response microphones (P/N 1961-3100 1-in. diameter and P/N 1962-3100 1/2-in. diameter). Typical frequency response and directional response characteristics are shown in Figures 3-1, 3-2, 3-3, 3-4 for the 4 microphone types.

3.3 OPTI-RANGE SYSTEM

Users of spectrum analyzers of any kind will recognize that these instruments invariably have two independently-adjustable level-range controls ("attenuators"). One control serves to change the gain of the amplifier ahead of the filter or weighting network and the other to change the gain of the amplifier which follows. The two controls allow the greatest analysis range and signal-to-noise ratio (dynamic range).

The 1933 Analyzer uses only a single level-range control. A control signal, that is dependent on both the setting of this control and the peak level of the signal presented to the filters or weighting networks, is used to set the gain of an

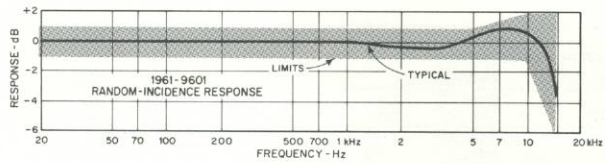

Typical random incidence response and tolerance.

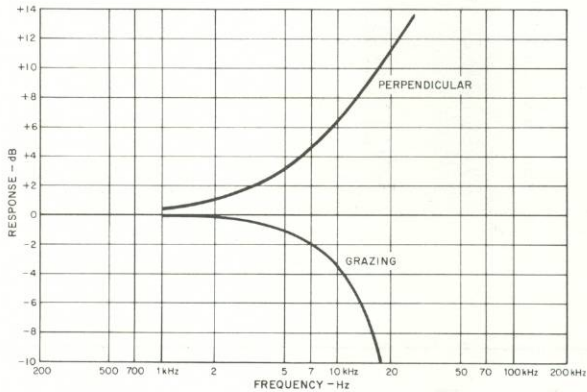

Correction to be added algebraically to random incidence response to find perpendicular and grazing incidence free-field response.

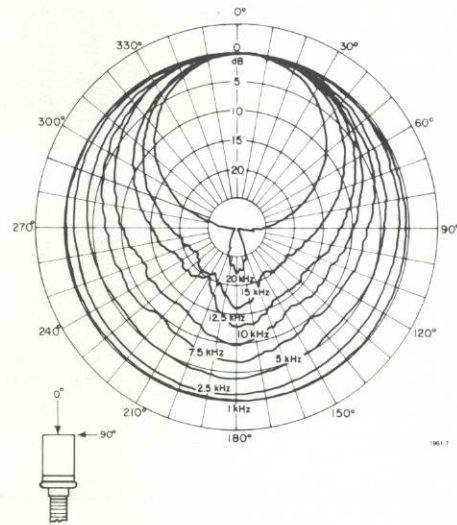

Typical directional response of the microphone.

Figure 3-1. Characteristics for 1-in. electret microphone – flat random-incidence response.

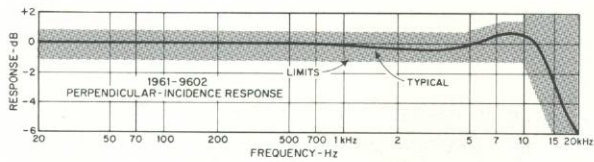

Typical perpendicular-incidence response and tolerance.

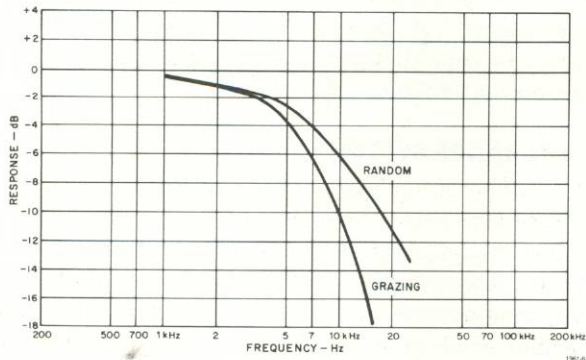

Correction to be added algebraically to perpendicular-incidence response to find random and grazing incidence free-field response.

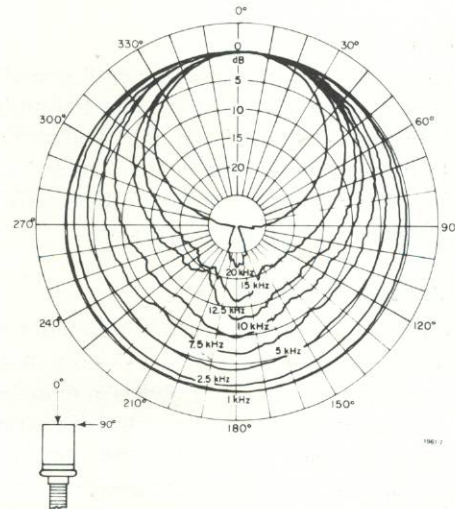

Typical directional response of the microphone.

Figure 3-2. Characteristics for 1-in. electret microphone – flat perpendicular-incidence response.

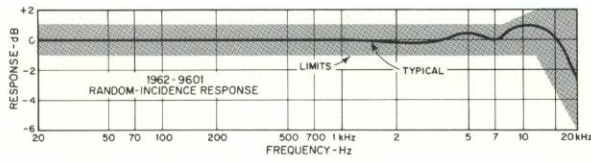

Typical random incidence response and tolerance.

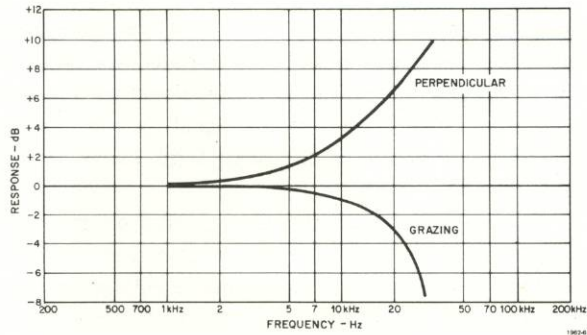

Correction to be added algebraically to random incidence response to find perpendicular and grazing incidence free-field response.

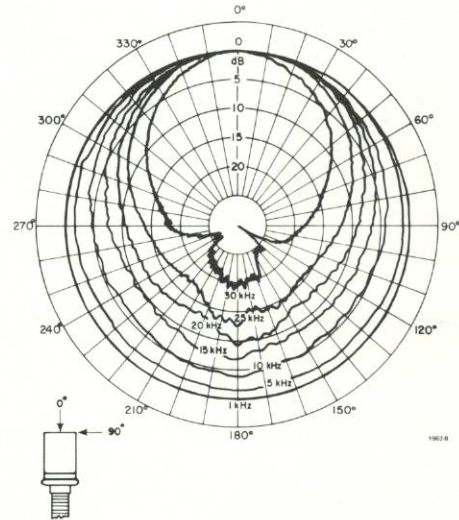

Typical directional response of the microphone.

Figure 3-3. Characteristics for 1/2-in. electret microphone – flat random-incidence response.

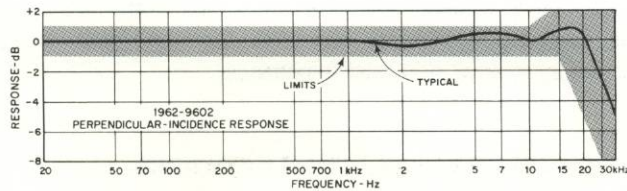

Typical perpendicular-incidence response and tolerance.

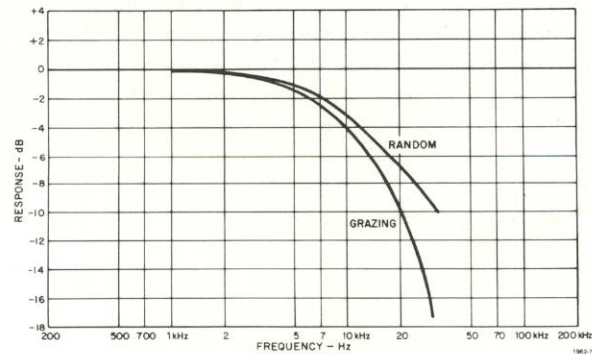

Correction to be added algebraically to perpendicular-incidence response to find random and grazing incidence free-field response.

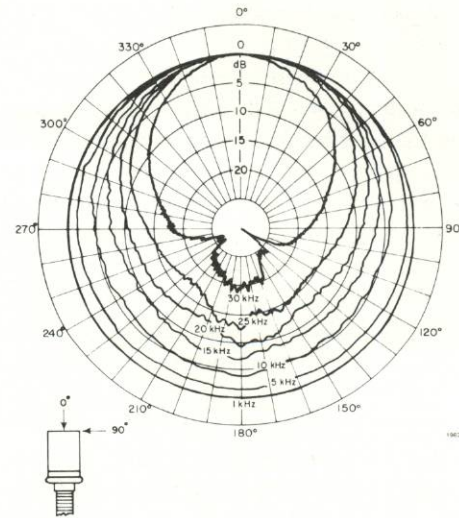

Typical directional response of the microphone.

Figure 3-4. Characteristics for 1/2-in. electret microphone – flat perpendicular-incidence response.

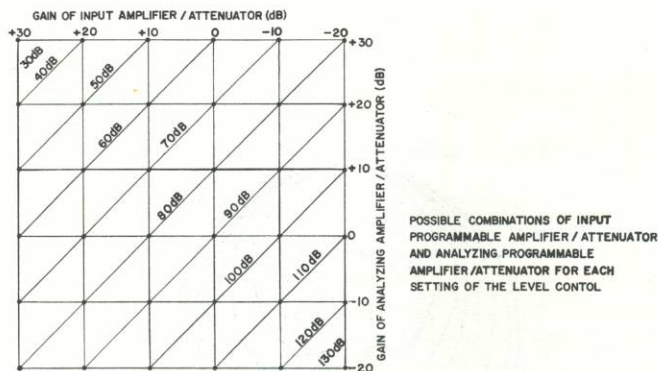

Figure 3-5. Automatic level-range control diagram.

input amplifier/attenuator and an analyzing amplifier/attenuator (see Figure 5-3) in such a way as to maximize the peak level of the signal being fed to the filter without overload. In the worst case, when a signal is suddenly applied to the instrument, about 4 seconds will elapse before the automatic system gives the optimum combination of gains for the input amplifier/attenuator and analyzing amplifier/attenuator. This is considerably less time than what would be required to manipulate dual, manual range controls. And, unlike the manual system, during this settling period the instrument is fully operative and capable of giving valid meter indications. A number of important benefits accrue from the automatic system.

1. Because there is only a single level-range control, there is no possibility of getting an invalid meter indication through misuse of controls.
2. It is unnecessary to make an "all pass" measurement of the signal before proceeding with an octave-band analysis. Measurement time is thus reduced.
3. If the level of the "all pass" signal should change during the analysis, the automatic system will correct for this change. In a conventional manual system an increase in overall level, after an octave band has been selected, may overload early stages in the analyzer and produce an invalid meter indication.
4. The output signal from the analyzer always has the maximum possible dynamic range for driving a magnetic tape recorder, graphic level recorder or, other device.
5. The system guards against overload even when the weighting networks are being used. Weighting networks are treated as filters so that high-level low-frequency components in a signal, whose A-weighted level is being measured, cannot overload front-end stages.

In some cases, for example, when measuring a transient signal (one available for measurement for only a few seconds) whose band levels are known approximately, it may be desirable to override the automatic system and

manually set the gain of the amplifier/attenuator circuits to save the 4-s settling time. The MANUAL OVERRIDE control used in combination with the main level-range control, provides standard manual operation for the occasional circumstance when the automatic system is not appropriate.

3.4 DETECTOR SYSTEM

The over-all detector system consists of an rms detector and a peak detector in cascade. The peak detector is bypassed for "fast" and "slow" while the rms detector is bypassed for "absolute peak." Both detectors are employed, to provide an indication proportional to the peak of the short time rms value of the signal, in the impulse mode. The meter has a 20-dB range with linear decibel divisions over the entire scale.

A d-c recorder used with the 1933 permits graphic level recording over a wide dynamic range. It is driven from the METER OUT (DC) jack which provides a voltage (or current) proportional to the logarithm of the detected signal (i.e., linear in decibels) over a range of 60 dB including a crest factor allowance of 20 dB. An output of 1 mA is available from this jack at full scale on the meter and any load impedance can be connected without affecting the source linearity or the indication of the meter.

Peak overload detectors at two critical points in the circuitry trigger the OVERLOAD lamp on the panel of the 1933. A meter indication is valid when the overload lamp is off but invalid when it is on.

Any load impedance can be connected to the analyzer's SIGNAL OUT (AC) jack and an undistorted signal will be delivered to any linear load impedance.

3.5 FILTERS AND WEIGHTING NETWORKS

The octave-band filters in the 1933 are resistance-capacitance-amplifier types using the Sallen and Key configuration with three two-pole (i.e. resonant) sections cascaded. The weighting networks A, B and C use much of the same circuitry as the octave-band filters. The normalized magnitude and phase responses of the filter are shown in Figures 2-2 and 2-3, respectively. The TO EXT FILTER and FROM EXT FILTER jacks allow an external filter to be substituted for the internal weighting or octave-band filter. The automatic range-control system is effective even for external networks.

3.6 POWER

The instrument operates from ordinary "C" size energizers deriving about 20 hours of operation from four cells. Optionally, rechargeable "C" cells may be used. These are charged from the 1940 Power Supply and Charger which also converts the analyzer to operate from the power line.

3.7 BLOCK DIAGRAM

The signal is fed from the MIKE, Figure 5-3, through the removable preamplifier to the input programmable amplifier/attenuator (U1). This signal is then fed in turn to the BUFFER AMPLIFIER (U2) octave filter and weighting network (U3, U4 and U5), the analyzing programmable amplifier/attenuator (U14), the mean square detector and log converter, the peak detector and finally the panel meter. The peak-or-peak detectors (U6, U8 and U7, U9) are driven with signals from the outputs of the programmable amplifier/attenuators. These outputs are then fed through an "or" circuit to an overload comparator (Q4 and Q5) which lights a panel lamp when an overload condition exists.

The first peak-or-peak detector also drives a reset comparator (U11) and a clock enable comparator (U10). If the peak signal is too high the reset comparator is tripped causing the counter (U13) to be "reset". When the counter is in its "reset" state, the gain of the input programmable amplifier/attenuator is set to the lowest gain possible within the bounds established by the operator through the setting of the level control. The signal from the peak or peak detector then decays through an acceptance band where neither comparator is tripped to a level sufficiently low to trip the clock enable comparator. The clock (U12) then

sends pulses to the counter which increases the gain of the input programmable amplifier/attenuator in 10 dB steps until the signal at the output of the peak-or-peak detector falls again within the acceptance band. When this occurs, the process stops. Each time the gain of the input programmable amplifier/attenuator is changed during this settling process, an equal and opposite change takes place in the gain of the analyzing programmable amplifier/attenuator so that the instrument always remains calibrated and meter readings taken even during the settling interval are valid. The manual override control may be used to preset the gain of the input programmable amplifier/attenuator thus allowing the instrument to operate in a conventional manual mode with dual controls.

Figure 3-5 shows the gain combinations possible for the input programmable amplifier/attenuator and the analyzing programmable amplifier/attenuator for each setting of the level control. The automatic system must follow the diagonal line labeled with the setting of the level control selected by the operator. For example, when the 80 dB range is selected, the sum of the "gains" must equal +10 dB and there are six combinations possible to make up this gain. Selection of the 30 dB or 130 dB range leaves only one possible gain combination.

d. Set:
1450
Attenuation 40 dB
Adjust the 1310 output for a reading of 4.5 V.

e. Repeat steps c and d, as necessary, until the 1807 reads between 6.12 and 6.28 V.

Gain and Meter Adjustment Procedures.

Continue the test setup shown in Figure 4-1.

a. Continue the previous control settings except as follows:

1933
RANGE dB Control 130 dB
1450
Attenuation 0 dB

b. Center the main CAL pot (R2) on the top edge of main board.

c. Attach probe leads from the 1808 Ac Voltmeter to AT1 (orange cable) and AT2 (signal ground) and adjust the 1310 output for a reading of 0.5 V. Refer to Figure 4-5 for location of AT1 and AT2. (This should require approximately 0.55 V out of the 1310, assuming ≈ 0.7 dB loss in the 1560-P9 dummy mike).

d. Using the 1560-P79 cable attach the 1808 to the SIGNAL OUT AC jack and adjust R12 (above AT1) for 0.5 V.

e. Set:
1450
Attenuation 13 dB
1933
IMP IN
IMPULSE/PEAK switch PEAK

f. Adjust R4 for a minimum reading on the 1933 panel meter. This null should occur near midscale. As a double check, while adjusting R4, observe waveform at CR7 anode

(junction CR7 and R15). See Figure 5-12 for waveforms. The peaks should be of equal amplitude at the null point.

g. Set:
1450
Attenuation 20 dB
1933
IMP OUT

h. Adjust the 1310 output for a 1933 meter reading on the bottom scale line (110 dB).

i. Set:
1450
Attenuation 0 dB

The meter should now read full-scale ± 0.4 dB. If the meter is more than 0.4 dB above full-scale, adjust R37 about halfway down to full-scale. If the meter is more than 0.4 dB below full-scale, adjust R37 about halfway up to full-scale.

j. Set:
1450
Attenuation 20 dB
Adjust the 1310 output for bottom scale reading again.

k. Repeat step i and j, as necessary, until the meter reading comes within ± 0.4 dB at full-scale.

NOTE

The 1310 output is always adjusted for a correct reading at bottom-scale and R37 adjusted at full-scale.

l. Set:
1450
Attenuation 0 dB
Adjust the 1310 output for a reading of 0.5 V at the SIGNAL OUT AC as read on the 1808.
m. Adjust R27 on the detector board for full-scale reading (130 dB) on the 1933 meter.
n. Connect the 1808 to EXT FILTER jack and measure the voltage to be $.09 \text{ V} \pm 5\%$ (.086 to .094 V). Reconnect the voltmeter to SIGNAL OUT AC.

o. Set:
1933
BAND Control 1 kHz
Check that the meter reads within ± 0.4 dB of full-scale; if not, perform the following filter alignment procedure.

Filter Alignment

This procedure is to be followed only if the above check is not met, the filter response check of para. 4.6.4 is not met, or a component is replaced in the filter section.

Use the same setup as in Figure 4-1. See Figure 4-3 for adjustment and test point locations.

a. Set the controls as follows:
1310
Frequency Dial 10
Frequency Range 200 Hz-2 kHz
1450-TB
Attenuation 60 dB

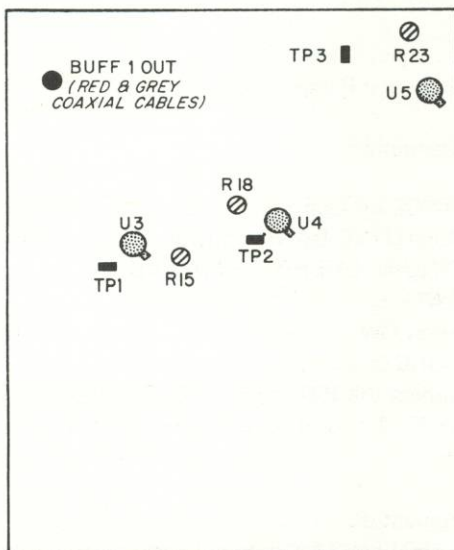

1933 11

Figure 4-3. Test points and adjustments for filter alignment.

**Table 4-7
OCTAVE-BAND LIMITS**

Nominal Center Freq. (Hz)	Exact Center Freq. (Hz)	3 dB down (Limits: -1.5 to -4.5)		½ f > 19 dB down (Hz)	2 f	1/11 f > 70 dB down (Hz)	11 f
		Lower	Upper				
31.5	31.62	22.70	44.05	15.75	63	2.86	346.5
63	63.09	45.29	87.88	31.5	126	5.73	693
125	125.9	90.37	175.4	63	250	11.38	1375
250	251.6	180.5	349.9	125	500	22.75	2750
500	501.2	359.8	698.2	250	1000	45.5	5500
1 k	1000	717.9	1393	500	2000	90.9	11,000
2 k	1995	1432	2779	1000	4000	181.8	22,000
4 k	3981	2858	5545	2000	8000	364	44,000
8 k	7943	5702	11065	4000	16,000	727	88,000
16 k	15848	11,890	21,077	8000	32,000	> 62 dB at 2 kHz (1/8)	> 62 dB at 128 kHz (8 X)

334-A

Function Sw Voltmeter
Meter Range Sw 0.1 V

1933

WEIGHTING/BAND Control 1 kHz Band
R23 (Main Board) fully ccw
RANGE dB Control 80 dB

b. Connect an HP334A through a GR 274-QBJ adaptor and a X1 probe to BUFF 1 OUT (at the junction of the red and grey coaxial cables). Set 1310 output for -5 dB as read on the 334-A.

c. Attach X1 probe to TP1 and set the 334-A to the 0.3 V range. Adjust the 1310 for peak. Adjust R15 for a -3.5 dB reading on 334-A (11.5 dB gain over BUFF 1).

d. Attach X1 probe to TP3 and move the 334-A to its 1 V range. Slowly sweep 1310 between 700 Hz and 1400 Hz. Note peak on both sides of 1 kHz. Adjust R18 until peak on low side is same as that on high side (R18 affects low side more than high side).

e. Attach X1 probe to BUFF 1 out and set:
1310 1 kHz
334-A 0.1 V range

f. Adjust 1310 output for -7 dB reading on 334-A.

g. Attach X1 probe to TP3 and move the 334-A to the 0.3 V range.

h. Adjust R23 for a reading of +1.4 dB on 334-A (18.4 dB gain over BUFF 1 OUT).

4.6.4 Filter-Response Check.

Use the set-up of Figure 4-1.

a. Set the controls as follows:

1310
FREQUENCY 1 kHz
1450-TB
Attenuation 70 dB

HP 334-A

FUNCTION Voltmeter
METER RANGE 0.1 V

1933

RANGE dB Control 80 dB (full scale)
WEIGHTING/BAND Control 1 kHz Band

b. Connect 334-A to the signal out AC jack (AJ4), with patch cord 1560-P79. Adjust the 1310 output for a 0 dB reading on the HP 334-A

c. Slowly sweep the 1310 oscillator dial to each side of 1 kHz and check that the peak-to-valley pass-band ripple is less than 1.0 dB, as read on HP 334-A.

d. Adjust the 1310 frequency to 717.9 Hz and 1393 Hz (using counter) and note that the -3 dB points fall within -1.5 to -4.5 dB on the HP 334-A.

e. Adjust the 1310 frequency dial to 500 Hz and 2 kHz. Reduce the 1450-TB attenuator by 20 dB and note that the 334-A reads greater than 19 dB down. Set 1450 back to 70 dB.

f. Adjust the 1310 frequency to 90.0 Hz and 11 kHz. Reduce 1450-TB attenuator by 70 dB and note that the HP 334-A reads >70 dB down.

Refer to Table 4-7 and repeat steps a through f for each of the remaining octave bands to be within the stated limits.

4.6.5 Uniformity of Level-Octave Bands.

a. Repeat the set-up and set the controls the same as para. 4.6.4 and retain the same connections.

b. Adjust the 1310 Output for 0 dB as read on the HP 334-A.

c. Refer to Table 4-7 and adjust 1310 to the center frequency of each octave band as the WEIGHTING BAND Control is switched to each octave-band setting. Compare the readings of the 334-A for each octave band. The levels of the bands should be uniform within 1 dB from 31.5 Hz to 8 kHz and within 2 dB for the 16 kHz band.

4.6.6 Internal Calibrator Adjustment.

Use same setup of Figure 4-1.

a. Set the controls as follows:

1310	Frequency Dial	10
	Frequency Range	200 Hz-2 kHz
	Output Level	0
1450-TB	Attenuation	0 dB
1933	Range dB Control	130 dB full scale
	BAND Control	1 kHz
	MANUAL OVERRIDE MAX dB Sw . . .	AUTO

Pushbuttons

FLAT	IN
IMP-SLOW	OUT (fast)
SOURCE Sw	TAPE

b. Adjust the 1310 output for a reading of 0.5 V at the SIGNAL OUT AC, as read on the 1808. The 1933 meter must now read 130 ±0.4 dB; if not, repeat the gain and meter adjustment, para. 4.6.3.

c. Set 1933 controls as follows:

RANGE dB control	100 dB (full scale)
WEIGHTING/BAND control	1 kHz Band
SOURCE Sw	CAL

Adjust CAL potentiometer E-R10 (on flex board between SOURCE switch and MANUAL OVERRIDE MAX dB switch — Figure 4-5) for a full-scale reading on the 1933 panel meter.

4.6.7 Adjustment of Blanking Period.

a. Retain the set-up of Figure 4-1 and set the controls as follows:

1310	Frequency Dial10
	Frequency Range	200 Hz-2 kHz
	Output Level	0
1450-TB	Attenuation	30 dB
1933	RANGE dB Control	100 dB (full scale)
	WEIGHTING/BAND Control	1 kHz Band
	SOURCE	TAPE

Tektronix 547 Scope:

Channel:	
VOLTS/cm	5
Input selector	DC

Triggering

Mode	Trig.
Slope	+
Coupling	AC
Source	INT.
Trigger Level	Negative transition
Time/cm	50 ms

b. Adjust the 1310 output for full scale on the 1933 panel meter.

c. Connect scope X1 probe to pin 11 of U12.

d. Adjust the oscilloscope triggering to obtain a negative pulse every time the 1450 is switched from 30 to 10 dB or from 10 to 30 dB. (Wait approximately 5 seconds between switchings).

e. Adjust R47 on the main board for a pulse width of 150 ms.

4.6.8 Meter Tracking and D-c Output Checks.

Meter Tracking.

a. Use the setup of Figure 4-1 and set the controls as follows:

1310 Oscillator	Frequency Dial10
	Frequency Range	200 Hz-2 kHz
	Output Level	0 V
1450-TB	Attenuation	44 dB
1933	WEIGHTING/BAND Control	WEIGHTING
	RANGE dB Control	100 dB (full scale)
	PEAK/IMP	IMP
	FLAT (Pushbuttons)	IN

b. Adjust the 1310 oscillator for a reading of 96 dB on the 1933 panel meter. Check other points as follows:

1450-TB	1933 Panel Meter (dB)
44 dB	96 dB (set)
40 dB	99.8 – 100.2
50 dB	89.6 – 90.2
55 dB	84.5 – 85.5
60 dB	79.5 – 80.5

Meter Functions:

a. With the 1450-TB attenuation set at 44 dB, change the oscillator to 315 Hz. Adjust the 1310 output for a 96-dB reading on the 1933 panel meter.

b. Set:

1933	FLAT, SLOW	IN
------	----------------------	----

The meter must read within ±0.1 dB of 96 dB.

c. Set:

1933	SLOW	OUT
	FLAT, IMP	IN

The meter must again read within ±0.1 dB of 96 dB.

d. Set:

1310	Frequency Dial	3.15
	Frequency Range	20 Hz – 200 Hz
1933	IMP	OUT
	FLAT, SLOW	IN

Adjust the 1310 output for a 96-dB reading on the meter.

- e. Set:
 1933
 SLOW OUT
 FLAT, IMP. IN

The meter must read within ± 0.7 dB of 96 dB.

- f. Set:
 1933
 PEAK/IMP PEAK
 1450
 Attenuation 47 dB

The meter must read within ± 0.5 dB of 96 dB.

D-c Output.

- a. Set:
 1933
 IMP OUT
 PEAK/IMP IMP
 1450
 Attenuation 40 dB
 1310
 Frequency Dial 10
 Frequency Range 200 Hz – 2 kHz

b. Connect an 1807 Millivoltmeter to the d-c output jack (AJ-3)* on the 1933. Adjust the 1310 output for full scale on the 1933 panel meter.

c. The 1807 must read between 4.3-4.7 V. Readjust the 1310 output for exactly 4.5 V on the 1807. Refer to the table below and check that the 1807 reads within the stated tolerances.

1450-TB	1807 Dc Millivoltmeter
40 dB	4.5 V set
60 dB	2.5 V \pm 50 mV
80 dB	0.5 V \pm 100 mV
23 dB	6.2 V \pm 50 mV

4.6.9 Weighting Check.

Use the same setup as in Figure 4-1.

- a. Set the controls as follows:
 1310
 Frequency Dial 10
 Frequency Range 200 Hz-2 kHz
 Output Level 0
 1450-TB
 Attenuation 60 dB
 1933
 RANGE dB Control 90 dB (full scale)
 WEIGHTING/BAND Control WEIGHTING
 Pushbuttons:
 FLAT IN
 SLOW IN

b. Adjust the 1310 output for an 80-dB reading on the 1933 panel meter. Check the FLAT response according to the table below. Keep the 1310 oscillator output level constant throughout the test.

*Use GR274-QBJ adaptor with 1933-P79 cable.

1310	1450-TB	1933
1 kHz	60 dB	80 dB
5 Hz	54.0 – 57.0 dB	80 dB
100 kHz	54 – 61 dB	80 dB

- c. Reset the controls as follows:
 1310 oscillator 1 kHz
 1450-TB
 Attenuation 60 dB
 1933
 Pushbutton:
 C IN

d. Adjust the 1310 output level for an 80-dB reference reading on the 1933 panel meter; keep the 1310 output constant throughout the tests.

e. Depress pushbutton B on the 1933.

f. Adjust the 1450-TB for an 80-dB reference reading on the 1933 panel meter. The 1450-TB must read between 59.8-60.2 dB.

g. Depress pushbutton A on the 1933.

h. Adjust the 1450-TB for an 80-dB reference reading on the 1933 panel meter. The 1450-TB must read 59.8-60.2 dB.

i. Check the frequency characteristics of the C, B, and A weighting networks individually. The 1450 limits are listed in the table below.

NOTE

Before checking each network, adjust the 1310 output set at 1 kHz for an 80-dB reference reading on the 1933 panel meter, with the 1450-TB set to 60 dB.

1450 TB Settings/Network

1310	C	B	A	1933 Level
1 kHz	60 dB	60 dB	60 dB	set for 80 dB
31.5 Hz	56.5–57.5	42.4–43.4	20.1–21.1	80 dB
125 Hz	59.8–60.2	55.3–56.3	43.4–44.4	80 dB
500 Hz	59.8–60.2	59.5–59.9	56.3–57.3	80 dB
8 kHz	56.5–57.5	56.6–57.6	58.4–59.4	80 dB

4.6.10 RANGE dB Control Check.

Use the same setup as in Figure 4-1.

NOTE

Connect the 1310 Oscillator, 1900 Wave analyzer, and the Counter on two line-power cords for this check to reduce ground loops.

- a. Set the controls as follows:
 1310 Oscillator
 Frequency Dial 10
 Frequency Range 200 Hz-2 kHz
 Output Level 0

- 1450-TB
 Attenuation 40 dB
- 1933
 RANGE dB Control 90 dB (full scale)
 WEIGHTING/BAND Control 1 kHz
- Pushbuttons:
 FLAT IN
 IMP-SLOW OUT (fast)
- 1900-A
 BANDWIDTH CPS 10
 Δ F-CPS 0
 MODE NORMAL
 READING RELATIVE
 FULL SCALE KNOB 1V
 FULL SCALE DIAL. 10 V (Input should not exceed)
 METER SPEED FAST

- b. Connect the 1900-A Wave Analyzer input to the 1933 A-J4 SIGNAL OUT AC jack via GR 1560-P77 cable.
- c. Adjust the 1310 Oscillator for a full scale reading on the 1933. Tune the 1900 WAVE ANALYZER to the frequency of the oscillator.
- d. Adjust the GAIN control on the 1900 WAVE ANALYZER for a 4-dB reference on the 1900 panel meter.
- e. Set the 1450-TB attenuator and the 1933 RANGE dB Control to the positions indicated in the table below. In each case, check the 1900 Wave Analyzer panel meter reading to be within the stated tolerances.
- f. Repeat the RANGE dB control test at 32 Hz and 50 kHz on FLAT position. Use 3 Hz BANDWIDTH on the 1900-A for the 32-Hz test.

1450 TB	1933 RANGE dB Control	1900-A panel meter
40	90	4 dB (set)
30	100	4 dB \pm 0.5 dB
20	110	4 dB \pm 0.5 dB
10	120	4 dB \pm 0.5 dB
0	130	4 dB \pm 0.5 dB
50	80	4 dB \pm 0.5 dB
60	70	4 dB \pm 0.5 dB
70	60	4 dB \pm 0.5 dB
80	50*	4 dB \pm 0.5 dB
90	40*	4 dB \pm 0.5 dB
100	30*	4 dB \pm 0.5 dB

*Set the 1900 Meter Speed Sw. to slow.

4.6.11 Noise and Signal Out Check.

Noise.

NOTE

The instrument must have covers installed for noise checks.

- a. Remove the input signal to the 1933 and short the input of the 1560-P9 Dummy Microphone with the BNC short.

- b. Set:
 1933

- Range dB Control 40 dB
 WEIGHTING/BAND Control WEIGHTING
 FLAT-SLOW IN
 SOURCE MIKE A

The internal noise as read on the 1933 meter must be less than 36 dB.[†]

- c. Measure the internal noise on other WEIGHTING and BAND ranges as follows.[†]

1933 Band Switch	1933 Weighting	1933 Band Range	Maximum 1933 Meter Reading (dB)
Weighting	C	40	30
Weighting	B	30	26
Weighting	A	30	25
31.5 Hz	—	30	28
1 kHz	—	30	17
16 kHz	—	30	22

Overload Capacity and Distortion Check.

NOTE

The following procedure requires the fabrication of the filter circuit shown in Figure 4-4.

- a. Retain the test set-up of Figure 4-1 except substitute the 1309 oscillator in place of the 1310.
- b. Connect the 100-kHz low-pass filter shown in Figure 4-4 between SIGNAL OUT AC jack and the input of the 334-A Distortion Analyzer, via the GR 274-QBJ Adaptor.

- c. Set:
 1450

Attenuation 20 dB

[†]Noise levels apply when calibrated for a -43 dB microphone, re 1V/N/m².

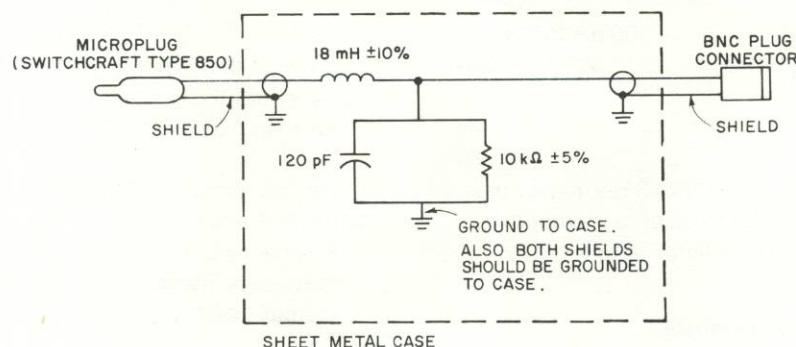

Figure 4-4. 100-kHz low-pass filter.

1933-12

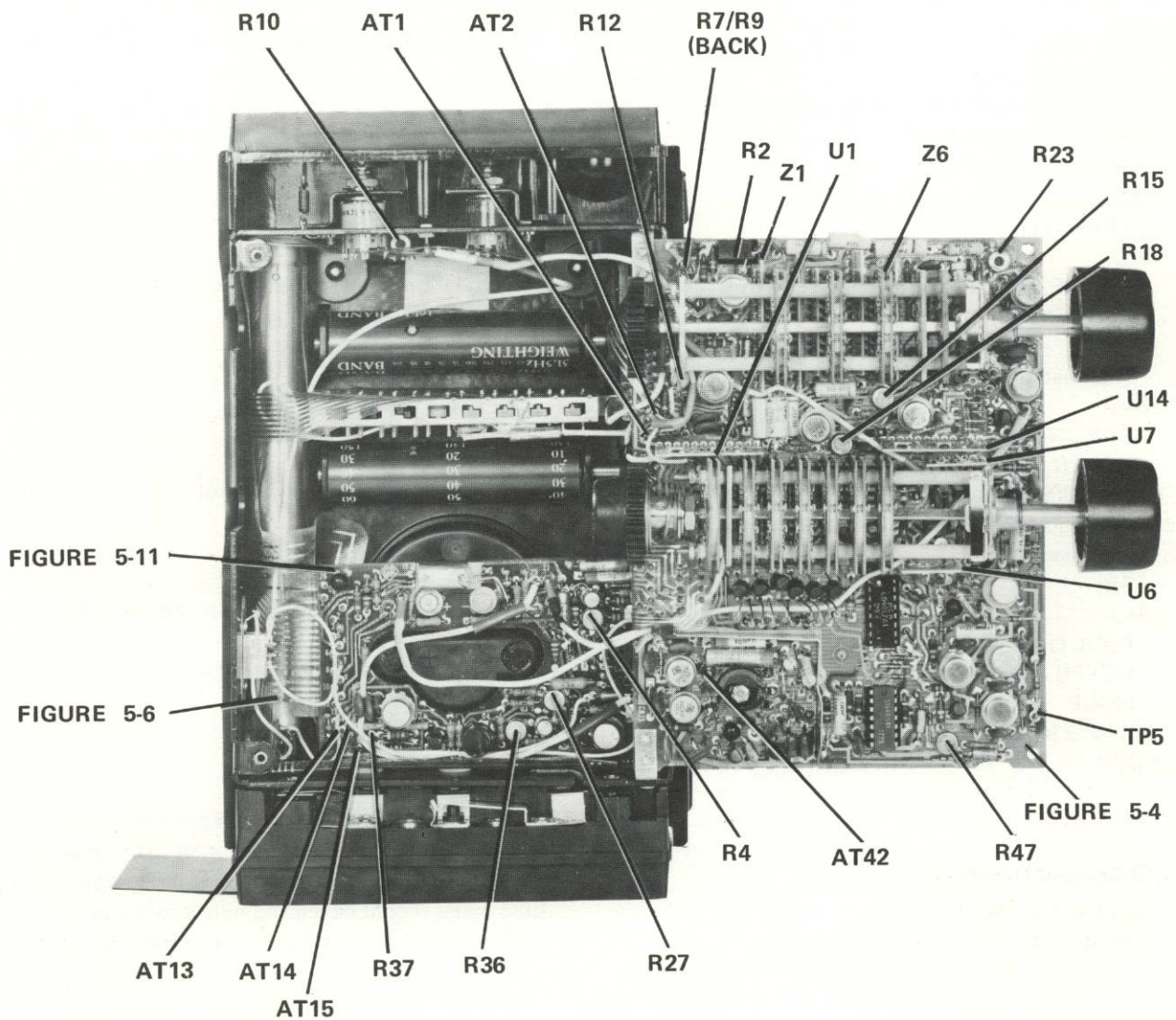

Figure 4-5. Interior of 1933.

1933

RANGE dB Control 120 dB
 WEIGHTING/BAND Control WEIGHTING
 FLAT IN
 SOURCE MIKE B

1309

FREQUENCY 1 kHz
 OUTPUT 2.0 V (on 1808)

334-A

FUNCTION VOLTMETER
 METER RANGE 1 V

d. Adjust R7 (Mike B adjust on rear of main board) for 20-dB meter reading (full-scale). This sets the gain for 0 dB microphone. Note the dB reading on the 334-A meter.

e. Set:

1450
 Attenuation 2 dB

334-A

METER RANGE 10 V

Check that the 334-A meter now reads between 17.7 to 18.3 dB above that noted in step d. Observe this output with the oscilloscope to verify that there is no waveform clipping.

f. Set:

1450
 Attenuation 20 dB

334-A

METER RANGE 1 V

1309-A

FREQUENCY 40 kHz

Note the dB reading on the 334-A meter.

g. Set:

1450
 Attenuation 10 dB

334-A
 METER RANGE 3 V
 Check that the 334-A meter now reads between 9 and 11 dB above that noted in step f.

h. Set:
 1309
 FREQUENCY 1 kHz
 1933
 RANGE dB Control 130 dB
 SOURCE TAPE
 1450
 Attenuation 0 dB

334-A
 FUNCTION SET LEVEL
 METER RANGE 100%
 Set the 1309 output for a full-scale reading on the 1933 meter and adjust the 334-A SENSITIVITY controls for a full-scale reading.

i. Set:
 334-A
 FUNCTION DISTORTION
 METER RANGE 0.3%
 MODE AUTOMATIC
 Null the 334-A and measure the distortion to be less than 0.2%.

a. Set controls as follows:
 1310
 Frequency Dial
 Frequency Range 200 Hz – 2 I
 1450
 Attenuation 20
 1396
 TRIGGER LEVEL
 SLOPE
 CYCLE COUNT NORM
 OUTPUT ON CC
 OUTPUT OFF 2 S
 TIMING (rear) I

1933
 RANGE dB control 130
 WEIGHTING/BAND Control WEIGHTI
 SOURCE TA
 FLAT
 IMP-SLOW C

The lamp behind CONT on the 1396 OUTPUT ON di should be on.

b. Adjust the 1310 output for a reading of 126 dB or 1933 meter.

c. Set:
 1396
 OUTPUT ON S

With the oscilloscope triggered from the 1396, adjust the 1396 OUTPUT ON vernier for an ON time of 0.2s (v waveform on the oscilloscope for accurate adjustment). 1933 meter should be reading fully down-scale and then Maximum up-scale reading should be from 124 to 126 dB

4.6.12 Detector Dynamics.

Fast-Slow-Impulse Dynamics.

Make the test setup shown in Figure 4-6.

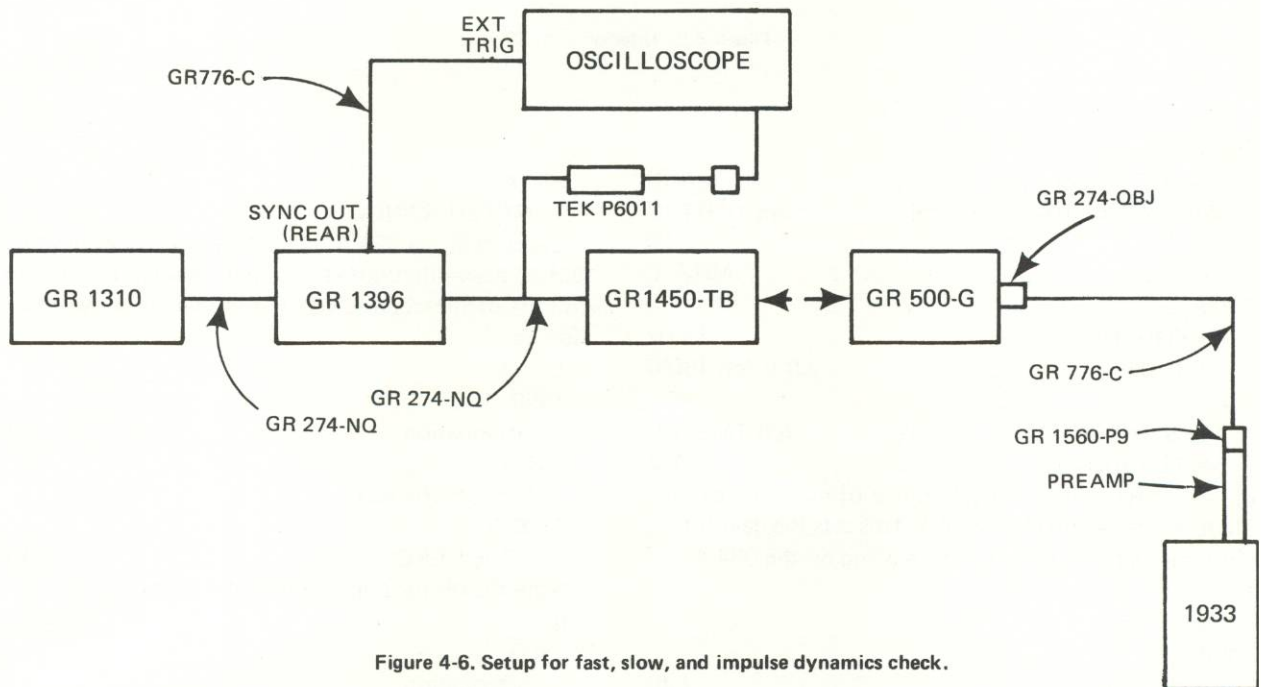

Figure 4-6. Setup for fast, slow, and impulse dynamics check.

d. Set:
 1396
 OUTPUT ON CONT
 The meter should overshoot the 126-dB mark and return. Maximum overshoot should be from 126.1 to 127.1 dB on the meter.

e. Set:
 1933
 FLAT-SLOW IN
 1396
 OUTPUT OFF. 5 SEC
 OUTPUT ON SEC
 Adjust the 1396 OUTPUT ON VERNIER for an ON time of 0.5s, using the oscilloscope for adjustment. The 1933 meter should again be going down-scale and then up. Maximum up-scale reading should be from 121 to 123 dB.

f. Set:
 1310
 Frequency Dial 20
 1933
 SLOW OUT
 FLAT-IMP IN
 PEAK/IMP IMP
 1396
 OUTPUT ON CONT
 OUTPUT OFF. 10 SEC
 Adjust the 1310 output for a reading of 130 dB on the 1933 meter.

g. Set:
 1396
 OUTPUT ON 20 mSEC (adjust with scope)
 Maximum up-scale reading should be from 124.9 to 127.9.

h. Set:
 1396
 OUTPUT ON 5 mSEC (adjust with scope)
 OUTPUT OFF. X 10 m SEC
 Adjust the 1396 OUTPUT OFF time for a repetition rate of 20 ms using the oscilloscope.

NOTE

Repetition rate is the time interval between the start of successive bursts.

The 1933 meter should now read from 123.9 to 126.4 dB.

Peak Dynamics.

Make the test setup shown in Figure 4-7

a. Set:
 1933
 PEAK/IMP PEAK (IMPACT)
 1340
 PULSE PERIOD/FREQ SINGLE PULSE
 PULSE DURATION Range X 10 ms
 PULSE OFFSET (Both) 0

Adjust the 1340 PULSE DURATION variable control to produce a 10-ms pulse, using the oscilloscope for adjustment. Push the SINGLE PULSE button to produce a pulse each time.

b. Adjust the + PULSE AMPLITUDE control (red) to produce a reading of 130 dB on the 1933 meter each time a pulse is injected (meter must go fully down-scale between pulses).

c. Set:
 1340
 PULSE DURATION Range X 100 μ s
 Adjust the PULSE DURATION variable control to produce a pulse of 200- μ s duration on the oscilloscope. (Do

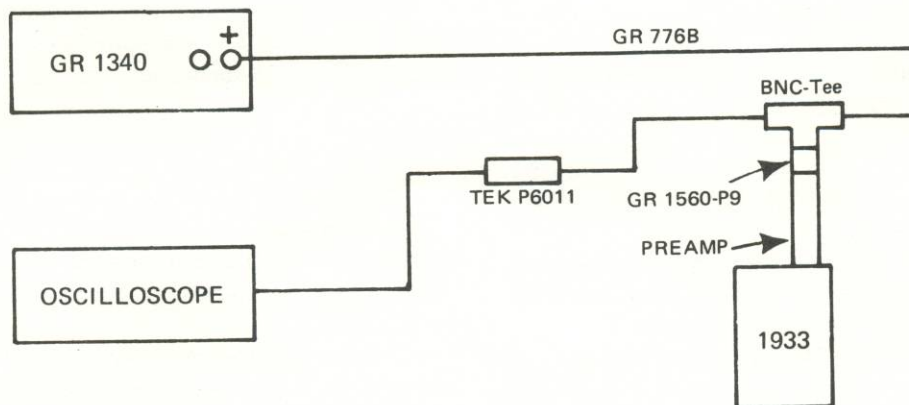

Figure 4-7. Setup for peak dynamics check.

not adjust the PULSE AMPLITUDE CONTROL). A single pulse of 200- μ s duration should produce a reading between 128 and 130 dB.

4.6.13 Amplifier Crest-Factor Capacity Check.

a. Retain the test set-up of Figure 4-1 and set the controls as follows:

- 1310
 - Frequency Dial 10
 - Frequency Range 200 Hz-2 kHz
 - Output Level 0
- 1450-TB
 - Attenuation 25 dB
- 1933
 - RANGE dB Control 120 dB (full scale)
 - WEIGHTING/Band Control WEIGHTING
 - FLAT (Pushbuttons) IN
 - SLOW-IMP OUT
 - SOURCE TAPE
 - PEAK/IMP IMP

b. Adjust the 1310 output level for full scale on the 1933 panel meter. Connect the scope to the SIG OUT AC jack (AJ-4).

c. Step the 1450-TB attenuator down in 1-dB steps and observe on scope the point above full scale at which output just begins to clip. The final 1450 indication must be less than 8 dB.

4.6.14 Opti-Range Check.

a. Use the same setup as Figure 4-1 and set the controls as follows:

- 1310 Oscillator
 - Frequency Dial 3.15
 - Frequency Range 20 Hz-200 Hz
 - Output Level 0
- 1450-TB
 - Attenuation 40 dB
- 1933
 - RANGE dB Control 90 dB (full scale)
 - WEIGHTING/BAND Control 31.5 Hz BAND
 - Pushbuttons
 - IMP-SLOW out (fast)

b. Connect the scope to the TO EXTERNAL FILTER jack A-J1 via 1560-P79 cable.

c. Adjust the 1310 output level for a full scale reading on the 1933 panel meter. Note the dB reading on the 1808 AC Millivoltmeter (connected to 1310 output).

d. Move the 1933 WEIGHTING/BAND control to 1 kHz BAND. Slowly increase the 1310 output level until the waveform on the scope suddenly decreases. This should occur 13.5–14.5 dB above the previously noted level at full scale. The drop in level corresponds to the U13 counter reset.

e. Within 4 seconds, the signal on the scope should settle to a new level, about 10 dB less than the level that existed just before the reset of U13 counter.

f. Reduce the 1310 output level and note the point at which the scope level suddenly increases by 10 dB. This should be 2 to 4 dB less than the reset level in step d.

4.6.15 Overload Detector Check.

Use the same setup as Figure 4-1 and set the controls as follows:

- 1310 Oscillator
 - Frequency Dial 10
 - Frequency Range 200 Hz-2 kHz
 - Output Level 0
- 1450-TB
 - Attenuation 70 dB
- 1933
 - RANGE dB Control 70 dB (full scale)
 - WEIGHTING/BAND Control WEIGHTING
 - Pushbuttons:
 - FLAT IN

Output Peak Detector.

a. Set the 1310 output level for a full-scale reading on the 1933 panel meter. Note the dB reading on the 1808 AC Millivoltmeter.

b. Slowly increase the output level of the 1310 Oscillator until the overload light just comes on. The 1808 AC Millivoltmeter should read 15 ± 0.5 dB greater than the value corresponding to full scale on the 1933. This checks the trigger level of U7 and U9.

c. Slowly reduce the output level of the 1310 oscillator until the overload light just goes off. This value should be 1.1 ± 0.5 dB less than the level at which the overload light just goes on.

Input Peak Detector.

For this check, remove the preamplifier section from the 1933 mast and connect the input directly using the microphone-mast-to-274 connector.

- a. Set:
 - 1933
 - RANGE dB Control 130 dB
 - 1450
 - Attenuation 10 dB

Adjust the 1310 output for a full-scale reading on the 1933 and then set the 1933 WEIGHTING/BAND Control to 31.5 Hz.

b. Slowly increase the output level of the 1310 until the overload light just comes on. The 1808 should again read 15 ± 0.5 dB greater than the value corresponding to full-scale on the 1933. This checks the trigger level of U6 and U8.

c. Slowly reduce the output level of the 1310 until the overload light just goes off. This should again be 1.1 ± 0.5 dB less than the level at which the overload light goes on.

4.6.16 Manual Override MAX dB Check.

a. Use the same setup as Figure 4-1 and set the controls as follows:

- 1310
 Frequency Dial 10
 Frequency Range 200 Hz-2 kHz
 Output Level 0
 1450-TB
 Attenuation 50 dB
 1933
 RANGE dB Control 80 dB (full scale)
 WEIGHTING/BAND Control 1 kHz BAND

b. Adjust the 1310 oscillator output level for a full-scale reading on the 1933 panel meter.

c. Switch the MANUAL OVERRIDE control through each of its other six positions (80 through 130, using the red dot as an indicator). The meter reading must stay the same for each setting and the OVERLOAD light must not be on at any setting, except briefly during switching.

d. Set:

- 1933
 RANGE dB Control 130 dB
 MANUAL OVERRIDE 130 (red dot)

The OVERLOAD light must be off and the meter fully down-scale.

e. Set the 1933 MANUAL OVERRIDE to each position 80 through 120 at red dot. The OVERLOAD light should be on in all positions and the meter fully down-scale.

f. Set the MANUAL OVERRIDE to AUTO (max ccw). The OVERLOAD light should be off.

4.6.17 Data Out Check.

This section checks the data available at the DATA OUT jack; this output is normally used in conjunction with the GR 1935 Cassette Data Recorder. Refer to the figure below for pin locations.

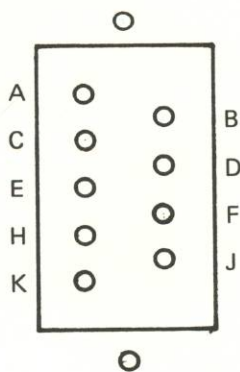

Figure 4-8. Data Out jack.

a. Measure the *ac* voltage from pin K to chassis ground; this should be between 0.475 and 0.525 V for a full-scale reading on the 1933 meter (SOURCE to CAL and RANGE dB Control to 100).

b. Measure the *dc* voltage from pin B to chassis ground, as the SOURCE switch is changed. Voltage should be as follows:

SOURCE SWITCH	VOLTAGE (pin B)
MIKE A	-9 V dc
MIKE B	+9 V dc
TAPE	+9 V dc

c. Measure the d-c resistance to be as follows:

Pin J to ground - 0Ω ($11 \Omega \pm 10\%$ on some early 1933's).

Pin F to ground - 0Ω .

d. Measure the d-c resistance to ground for pins A, C, E and H at various 1933 RANGE settings, according to Table 4-8. X indicates a short and blank indicates open.

Table 4-8
RANGE DATA OUT

RANGE switch	PIN A (1)	PIN C (2)	PIN E (4)	PIN H (8)
30	X	X		
40			X	
50	X		X	
60		X	X	
70	X	X	X	
80				X
90	X			X
100		X		X
110	X	X		X
120			X	X
130	X		X	X

4.7 FINAL CALIBRATION WITH MICROPHONES.

4.7.1 General.

The following acoustical calibration procedure should be followed when the 1933 is supplied with both the 1/2-in. and 1-in. microphones.

4.7.2 Calibration with 1-in. Microphone.

a. Attach 1-in. microphone (with the 1961-3200 adaptor supplied) to the 1933 preamplifier assembly.

b. Set the controls to the following positions:

- 1933
 RANGE dB Control 120 dB (full scale)
 WEIGHTING/BAND Control WEIGHTING
 SOURCE Sw MIKE B
 MANUAL OVERRIDE Control AUTO
 Pushbuttons
 FLAT IN
 IMP-SLOW OUT (fast)
 MAX MIKE dB 130

1562-A Calibrator

OFF-START-FREQUENCY SW 1 kHz

c. Place the 1562 on the microphone (with appropriate adaptor ring) and adjust the MIKE B CAL potentiometer on back of main circuit board for a 114-dB reading on the 1933 panel meter.

4.7.3 Calibration with 1/2-in. Microphone.

- a. Remove the 1-in. microphone (with adaptor) from the preamplifier assembly and connect the 1/2-in. microphone directly.
- b. Set the 1933 SOURCE switch to MIKE A.
- c. Place the 1562 (at 1 kHz) on the microphone (with appropriate adaptor ring) and adjust MIKE A CAL potentiometer, on back of main circuit board, for a 114-dB reading on the 1933 panel meter.

4.7.4 Calibration When Only 1/2-in. Mike is Supplied.

The following acoustical calibration procedure should be followed when the 1933 is supplied with 1/2-in. microphone only.

- a. The controls remain the same as para 4.7.2.
- b. Connect 1/2-in. microphone to the 1933 preamp assembly.
- c. Repeat step c in para 4.7.2.
- d. Remove the microphone, connect the 10 dB microphone attenuator (supplied) to the preamp assembly, then remount the microphone.
- e. Set the 1933 controls:
 - MAX MIKE dB 140
 - Range dB 120 (full scale)
 - SOURCE MIKE A
 Repeat step c in para 4.7.3.

Parts Lists and Diagrams—Section 5

MECHANICAL PARTS — FRONT AND RIGHT SIDES	5-2
MECHANICAL PARTS — LEFT SIDE	5-3
FEDERAL MANUFACTURERS CODE	5-4
OVER-ALL BLOCK DIAGRAM	5-5
SCHEMATIC DIAGRAM FOR 1933 ANALOG CIRCUITS	5-7
SCHEMATIC DIAGRAM FOR 1933 DIGITAL CIRCUITS	5-9
SCHEMATIC DIAGRAM FOR 1933 POWER SUPPLY	5-11
SCHEMATIC DIAGRAM FOR 1933 DETECTOR CIRCUIT	5-13

NOTE

Each reference designator used in our schematic diagrams and circuit descriptions includes an initial letter, before a hyphen, to identify the subassembly (except that A refers to the main frame). The numeric portion of each designator is generally shorter than would be the case if a block of numbers were assigned to each subassembly. The designation of wire-tie points is AT (anchor terminal). The letter before the hyphen may be omitted only if clearly understood, as within a subassembly schematic diagram.

Examples: B-R8 designates B board, resistor 8; D-AT2 = D board, wire-tie point 2, CR6 on the V schematic is a shortened form of V-CR6 = V board, diode 6. The instrument may contain A-R1, B-R1, C-R1, and D-R1.

Parts lists and etched-board drawings appear just before corresponding reference views or schematic diagrams.

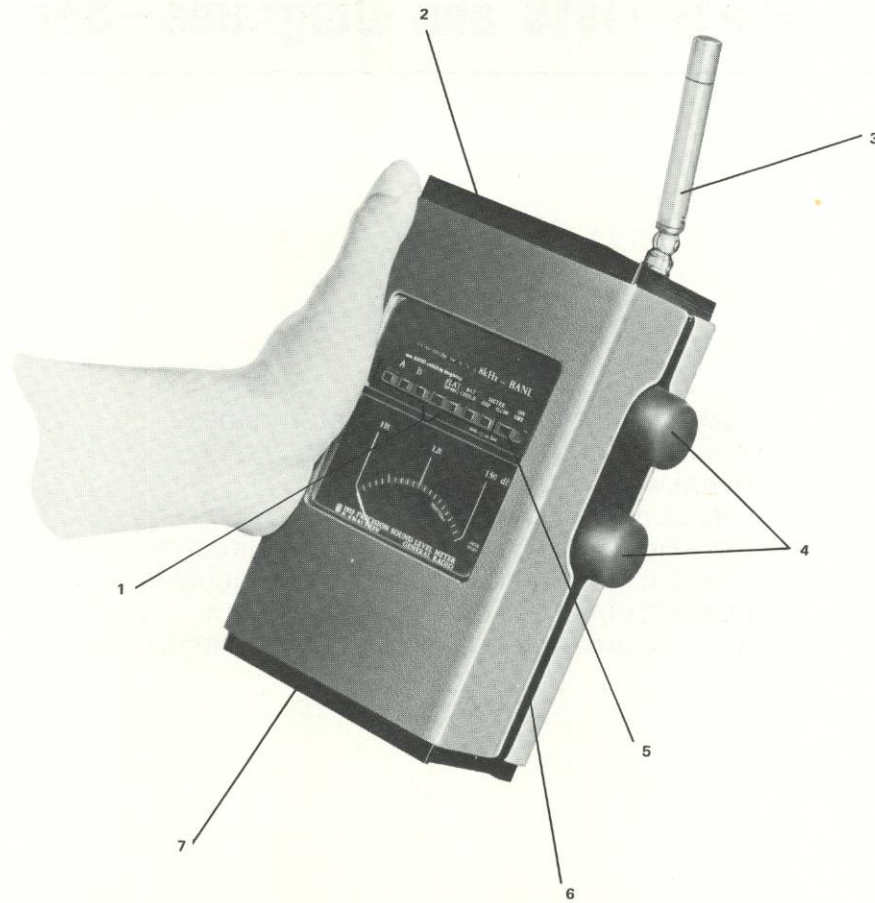

Figure 5-1. Mechanical parts — 1933 front and right side.

MECHANICAL PARTS LIST

Fig Ref	Qty	Description	GR Part No.	Fed Mfg Code	Mfg Part No.	Fed Stock No.
1	7	Pushbutton black, A, B, C FLAT (or ext), BAT CHECK METER IMP SLOW	5511-0403	24655	5511-0403	
2	1	Microphone housing COVER asm.	1933-1080	24655	1933-1080	
3	1	Microphone mast asm.	1933-2000	24655	1933-2000	
4	2	Knob Asm. requires: bushing	5520-5435 4143-3161	24655	5520-5435 4143-3161	
5	1	Pushbutton, white ON, OFF	5511-0406	24655	5511-0406	
6	1	Switch, toggle A-S1 IMPULSE, PEAK IMPACT	7910-0460	71744	23-021-118	
7	1	Cover, battery compartment	1933-8030	24655	1933-8030	
		MISCELLANEOUS				
	1	Knob, black SOURCE-(Mike A, B, TAPE, CAL)	1933-6091	24655	1933-6091	
	1	Knob, black Auto, MANUAL OVERRIDE, MAX dB, Meter assembly	1933-6092 5730-1933	24655	1933-6092 5730-1933	

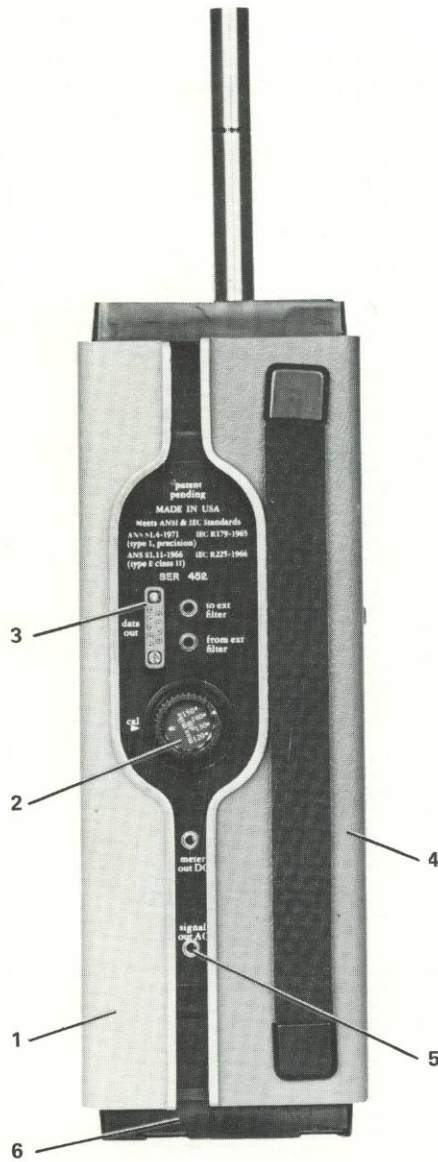

Figure 5-2. Mechanical parts – 1933 left side.

MECHANICAL PARTS LIST (cont)

Fig Ref	Qty	Description	GR Part No.	Fed Mfg Code	Mfg Part No.	Fed Stock No.
1	1	Bottom cover asm.	1933-1070	24655	1933-1070	
2	1	Knob assy	1933-7071	24655	1933-7071	
3	1	Connector, A-J5 DATA OUT	4230-1210	24655	4230-1210	
4	1	Top cover asm.	1933-1040	24655	1933-1040	
5	4	Connector, miniature A-J1, 2, 3, 4 TO EXT FILTER, FROM EXT FILTER, METER OUT DC, SIGNAL OUT AC	4260-1110	82389	TR-2A	
6	1	Battery Compartment Asm.	1933-2010	24655	1933-2010	

FEDERAL MANUFACTURER'S CODE

From Federal Supply Code for Manufacturers Cataloging Handbooks H4-1
(Name to Code) and H4-2 (Code to Name) as supplemented through August, 1968.

Code	Manufacturer	Code	Manufacturer	Code	Manufacturer
00192	Jones Mfg. Co, Chicago, Illinois	42498	National Co, Inc, Melrose, Mass. 02176	80894	Pure Carbon Co., St. Marys, Penn. 15857
00194	Walsco Electronics Corp, L.A., Calif.	43991	Norma-Hoffman, Stanford, Conn. 06904	81030	International Instrument, Orange, Conn.
00434	Schweber Electronics, Westburg, L.I., N.Y.	49671	RCA, New York, N.Y. 10020	81073	Grayhill Inc, LaGrange, Ill. 60525
00656	Aerovox Corp, New Bedford, Mass.	49956	Raytheon Mfg Co, Waltham, Mass. 02154	81143	Isolantite Mfg Corp, Stirling, N.J. 07980
01009	Alden Products Co, Brockton, Mass.	53021	Sangamo Electric Co, Springfield, Ill. 62705	81349	Military Specifications
01121	Allen-Bradley, Co, Milwaukee, Wisc.	54294	Shallcross Mfg Co, Selma, N.C.	81350	Joint Army-Navy Specifications
01236	Leeds Radio Company, N.Y.	54715	Shure Brothers, Inc, Evanston, Ill.	81386	Fenwal Electronics, Framingham, Mass. 01701
01255	Litton Industries Inc, Beverly Hills, Calif.	56289	Sprague Electric Co, N. Adams, Mass.	81483	International Rectifier Corp, El Segundo, Calif. 90245
01295	Texas Instruments, Inc, Dallas, Texas	59730	Thomas and Betts Co, Elizabeth, N.J. 07207	81751	Columbus Electronics Corp, Yonkers, N.Y.
02114	Ferroxcube Corp, Saugerties, N.Y. 12477	59875	TRW Inc, (Accessories Div), Cleveland, Ohio	81831	Filtron Co, Flushing, L.I., N.Y. 11354
02606	Fenwal Lab Inc, Morton Grove, Ill.	60399	Torrington Mfg Co, Torrington, Conn.	81840	Ledex Inc, Dayton, Ohio 45402
02660	Amphenol Electron Corp, Broadview, Ill.	61637	Union Carbide Corp, New York, N.Y. 10017	81860	Barry-Wright Corp, Watertown, Mass.
02768	Fastex, Des Plaines, Ill. 60016	61864	United-Carr Fastener Corp, Boston, Mass.	82219	Sylvania Elec Prod, Emporium, Penn.
03042	Carter Ink Co., Camb. Mass. 02142	63060	Victoreen Instrument Co, Inc, Cleveland, O.	82273	Indiana Pattern & Model Works, LaPort, Ind.
03508	G.E. Semicon Prod, Syracuse, N.Y. 13201	63743	Ward Leonard Electric Co, Mt. Vernon, N.Y.	82389	Switchcraft Inc, Chicago, Ill. 60630
03636	Grayburne, Yonkers, N.Y. 10701	65083	Westinghouse (Lamp Div), Bloomfield, N.J.	82647	Metals & Controls Inc, Attleboro, Mass.
03888	Pyrofilm Resistor Co, Cedar Knolls, N.J.	65092	Weston Instruments, Newark, N.J.	82807	Milwaukee Resistor Co, Milwaukee, Wisc.
03911	Clairex Corp, New York, N.Y. 10001	70485	Atlantic-India Rubber, Chicago, Ill. 60607	82877	Rotron Mfg. Co. Inc., Woodstock, N.Y. 12498
04009	Arrow-Hart & Hegeman, Hart., Conn. 06106	70563	Amperite Co, Union City, N.J. 07087	83033	Meissner Mfg. (Maguire Ind) Mt. Carmel, Ill.
04643	Digitronics Corp., Alburtson, N.Y. 11507	70903	Belden Mfg Co, Chicago, Ill. 60644	83058	Carr Fastener Co, Cambridge, Mass.
04713	Motorola, Phoenix, Ariz. 85008	71126	Bronson, Homer D, Co, Beacon Falls, Conn.	83186	Victory Engineering, Springfield, N.J. 07081
05170	Engr'd Electronics, Santa Ana, Calif. 92702	71279	Cambridge Thermionic Corp, Camb. Mass. 02138	83361	Bearing Specialty Co, San Francisco, Calif.
05624	Barber-Colman Co, Rockford, Ill. 61101	71294	Canfield, H.O. Co, Clifton Forge, Va. 24422	83587	Solar Electric Corp, Warren, Penn.
05748	Barnes Mfg. Co., Mansfield, O. 44901	71400	Bussman (McGraw Eidsen), St. Louis, Mo.	83740	Union Carbide Corp, New York, N.Y. 10017
05820	Wakefield Eng, Inc, Wakefield, Mass. 01880	71468	ITT Cannon Elec, L.A., Calif. 90031	83781	National Electronics Inc, Geneva, Ill.
06743	Clevite Corp., Cleveland, O. 44110	71590	Centralab, Inc, Milwaukee, Wisc. 53212	84411	TRW Capacitor Div, Ogallala, Nebr.
07126	Digitron Co, Pasadena, Calif.	71666	Continental Carbon Co, Inc, New York, N.Y.	84835	Lehigh Metal Prods, Cambridge, Mass. 02140
07127	Eagle Signal (E.W. Bliss Co.), Baraboo, Wisc.	71729	Crescent Box Corp, E. Phila, Penn. 19134	84971	TA Mfg Corp, Los Angeles, Calif.
07261	Avnet Corp, Culver City, Calif. 90230	71707	Coto Coil Co Inc, Providence, R.I.	86577	Precision Metal Prods, Stoneham, Mass. 02180
07263	Fairchild Camera, Mountain View, Calif.	71744	Chicago Miniature Lamp Works, Chicago, Ill.	86684	RCA (Elect. Comp & Dev), Harrison, N.J.
07387	Birtcher Corp, No. Los Angeles, Calif.	71785	Cinch Mfg Co, Chicago, Ill. 60624	86687	REC Corp, New Rochelle, N.Y. 10801
07595	Amer Semicond, Arlington Hts, Ill. 60004	71823	Darnell Corp, Ltd, Downey, Calif. 90241	86800	Cont Electronics Corp, Brooklyn, N.Y. 11222
07828	Bodine Corp, Bridgeport, Conn. 06605	72136	Electro Motive Mfg Co, Wilmington, Conn.	88140	Cutler-Hammer Inc, Lincoln, Ill.
07829	Bodine Electric Co, Chicago, Ill. 60618	72259	Nytronics Inc, Berkeley Heights, N.J. 07922	88219	Gould Nat. Batteries Inc, Trenton, N.J.
07910	Cont Device Corp, Hawthorne, Calif.	72619	Dialight Co, Brooklyn, N.Y. 11237	88419	Cornell-Dubilier, Fuquay-Varina, N.C.
07983	State Labs Inc, N.Y., N.Y. 10003	72699	General Instr Corp, Newark, N.J. 07104	88627	K & G Mfg Co, New York, N.Y.
07999	Borg Inst., Delavan, Wisc. 53115	72765	Drake Mfg Co, Chicago, Ill. 60656	89482	Holtzer-Cabot Corp, Boston, Mass.
08730	Vemaline Prod Co., Franklin Lakes, N.J.	72825	Hugh H. Eby Inc, Philadelphia, Penn. 19144	89665	United Transformer Co, Chicago, Ill.
09213	G.E. Semiconductor, Buffalo, N.Y.	72962	Elastic Stop Nut Corp, Union, N.J. 07083	90201	Mallory Capacitor Co, Indianapolis, Ind.
09408	Star-Tronics Inc, Georgetown, Mass. 01830	72982	Erie Technological Products Inc, Erie, Penn.	90634	Gulton Industries, Inc, Metuchen, N.J. 08840
09823	Burgess Battery Co, Freeport, Ill.	73138	Beckman Inc, Fullerton, Calif. 92634	90750	Westinghouse Electric Corp, Boston, Mass.
09922	Burndy Corp, Norwalk, Conn. 06852	73445	Amperex Electronics Co, Hicksville, N.Y.	90952	Hardware Products Co, Reading, Penn. 19602
11236	C.T.S. of Berne, Inc, Berne, Ind. 46711	73559	Carling Electric Co, W. Hartford, Conn.	91032	Continental Wire Corp, York, Penn. 17405
11599	Chandler Evans Corp, W. Hartford, Conn.	73690	Elco Resistor Co, New York, N.Y.	91146	ITT (Cannon Electric Inc), Salem, Mass.
12040	National Semiconductor, Danbury, Conn.	73899	JFD Electronics Corp, Brooklyn, N.Y. 11219	91210	Gerber Mfg. Co, Mishawaka, Ind.
12498	Crystalonics, Cambridge, Mass. 02140	74193	Heinemann Electric Co, Trenton, N.J.	91293	Johanson Mfg Co, Boonton, N.J. 07005
12672	RCA, Woodbridge, N.J.	74861	Industrial Condenser Corp, Chicago, Ill. 60618	91506	Augat Inc, Attleboro, Mass. 02703
12697	Clarostat Mfg Co, Inc, Dover, N.H. 03820	74868	Amphenol Corp, Danbury, Conn. 06810	91598	Chandler Co, Wethersfield, Conn. 06109
12954	Dickson Electronics, Scottsdale, Ariz.	74970	E.F. Johnson Co, Waseca, Minn. 56093	91637	Dale Electronics Inc, Columbus, Nebr.
13327	Solitron Devices, Tappan, N.Y. 10983	75042	IRC Inc, Philadelphia, Penn. 19108	91662	Elco Corp, Willow Grove, Penn.
14433	ITT Semiconductors, W. Palm Beach, Fla.	75382	Kulka Electric Corp, Mt. Vernon, N.Y.	91719	General Instruments, Inc, Dallas, Texas
14655	Cornell-Dubilier Electric Co., Newark, N.J.	75491	Lafayette Industrial Electronics, Jamaica, N.Y.	91916	Mephisto Tool Co, Inc, Hudson, N.Y. 12534
14674	Corning Glass Works, Corning, N.Y.	75608	Linden and Co, Providence, R.I.	91929	Honeywell Inc, Freeport, Ill.
14936	General Instrument Corp, Hicksville, N.Y.	75915	Littelfuse, Inc, Des Plaines, Ill. 60016	92519	Electra Insul Corp, Woodside, L.I., N.Y.
15116	Microdot Magnetics Inc, Los Angeles, Calif.	76005	Lord Mfg Co, Erie, Penn. 16512	92678	E.G.&G., Boston, Mass.
15238	ITT, Semiconductor Div, Lawrence, Mass.	76149	Mallory Electric Corp, Detroit, Mich. 48204	92739	Amper Corp, Redwood City, Calif. 94063
15605	Cutler-Hammer Inc, Milwaukee, Wisc. 53233	76487	James Millen Mfg Co., Malden, Mass. 02148	93332	Sylvania Elect Prods, Inc, Woburn, Mass.
16037	Spruce Pine Mica Co, Spruce Pine, N.C.	76545	Mueller Electric Co., Cleveland, Ohio 44114	93618	R. & C. Mfg. Co of Penn. Inc, Ramey, Penn.
16636	Indiana General Corp, Oglesby, Ill. 61348	76684	National Tube Co, Pittsburg, Penn.	93916	Cramer Products Co, New York, N.Y. 10013
17771	Singer Co, Diehl Div, Somerville, N.J.	76854	Oak Mfg Co, Crystal Lake, Ill.	94144	Raytheon Co, Components Div, Quincy, Mass.
18736	Voltronics Corp, Hanover, N.J. 07936	77147	Patton MacGuyver Co, Providence, R.I.	94154	Tung Sol Electric Inc, Newark, N.J.
19396	Illinois Tool Works, Pakton Div, Chicago, Ill.	77166	Pass-Seymour, Syracuse, N.Y.	94271	Weston Instruments Inc, Archibald, Penn. 18403
19048	Computer Diode Corp, S. Fairlawn, N.J. 07410	77263	Pierce Roberts Rubber Co, Trenton, N.J.	94589	Dickson Co., Chicago, Ill. 60619
19617	Cabtron Corp., Chicago, Ill. 60622	77339	Positive Lockwasher Co, Newark, N.J.	94800	Atlas Industrial Corp., Brooklyn, N.H.
19644	LRC Electronics, Horseheads, N.Y.	77342	American Machine & Foundry Co, Princeton, Ind. 47570	95076	Garde Mfg. Co., Cumberland, R.I.
19701	Electra Mfg Co, Independence, Kansas 67301	77542	Ray-O-Vac Co, Madison, Wisc.	95121	Quality Components Inc, St. Mary's, Penn.
20754	KMC Semiconductor Corp., Long Valley, N.J. 07853	77630	TRW, Electronic Comp, Camden, N.J. 08103	95146	Alco Electronics Mfg Co, Lawrence, Mass.
21335	Fafnir Bearing Co, New Briton, Conn.	77638	General Instruments Corp, Brooklyn, N.Y.	95238	Continental Connector Corp, Woodside, N.Y.
22753	UID Electronics Corp, Hollywood, Fla.	78189	Shakeproof (Ill. Took Works), Elgin, Ill. 60120	95275	Vitramon, Inc, Bridgeport, Conn.
23342	Avnet Electronics Corp, Franklin Park, Ill.	78277	Sigma Instruments Inc, S. Braintree, Mass.	95354	Methode Mfg Co, Chicago, Ill.
24446	G.E., Schenectady, N.Y. 12305	78488	Stackpole Carbon Co, St. Marys, Penn.	95412	General Electric Co, Schenectady, N.Y.
24454	G.E., Electronics Comp, Syracuse, N.Y.	78553	Tinnerman Products, Inc, Cleveland, Ohio	95794	Anaconda Amer Brass Co, Torrington, Conn.
24455	G.E. (Lamp Div.), Nela Park, Cleveland, Ohio	79089	RCA, Rec Tube & Semicond, Harrison, N.J.	96095	Hi-Q Div. of Aerovox Corp, Orleans, N.Y.
24655	General Radio Co, W. Concord, Mass. 01781	79725	Wiremold Co, Hartford, Conn. 06110	96214	Texas Instruments Inc, Dallas, Texas 75209
26806	American Zettlet Inc, Costa Mesa, Calif.	79963	Zierick Mfg Co, New Rochelle, N.Y.	96256	Thordarson-Meissner, Mt. Carmel, Ill.
28520	Hayman Mfg Co, Kenilworth, N.J.	80009	Tektronix Inc, Beaverton, Ore. 97005	96341	Microwave Associates Inc, Burlington, Mass.
28959	Hoffman Electronics Corp, El Monte, Calif.	80030	Prestole Fastener, Toledo, Ohio	96791	Amphenol Corp, Janesville, Wisc. 53545
30646	Beckman Instruments Inc, Cedar Grove, N.J. 07009	80048	Vickers Inc, St. Louis, Mo.	96906	Military Standards
30874	I.B.M., Armonk, New York	80131	Electronic Industries Assoc, Washington, D.C.	97684	Models Inc, North Bergen, N.J.
32001	Jensen Mfg. Co, Chicago, Ill. 60638	80183	Sprague Products Co, No. Adams, Mass.	98291	Sealeator Corp, Mamaroneck, N.Y. 10544
33173	G.E. Comp, Owensboro, Ky. 42301	80211	Motorola Inc., Franklin Park, Ill. 60131	98474	Compar Inc, Burlingame, Calif.
34141	Koehler Mfg. Co. Inc., Marlboro, Mass. 01752	80258	Standard Oil Co, Lafayette, Ind.	98821	North Hills Electronics Inc., Glen Cove, N.Y.
35929	Constanta Co, Mont. 19, Que.	80294	Bourns Inc, Riverside, Calif. 92506	99117	Metavac Inc, Flushing, N.Y. 11358
37942	P.R. Mallory & Co Inc, Indianapolis, Ind.	80368	Sylvania Electric Products Inc, N.Y. 10017	99180	Transiron Electronics Corp, Melrose, Mass.
38443	Marlin-Rockwell Corp, Jamestown, N.Y.	80431	Air Filter Corp, Milwaukee, Wisc. 53218	99313	Varian, Palo Alto, Calif. 94303
40931	Honeywell Inc, Minneapolis, Minn. 55408	80583	Hammarlund Co, Inc, New York, N.Y.	99378	Atlee Corp, Winchester, Mass. 01890
42190	Muter Co, Chicago, Ill. 60638	80740	Beckman Instruments, Inc, Fullerton, Calif.	99800	Delevan Electronics Corp, E. Aurora, N.Y.

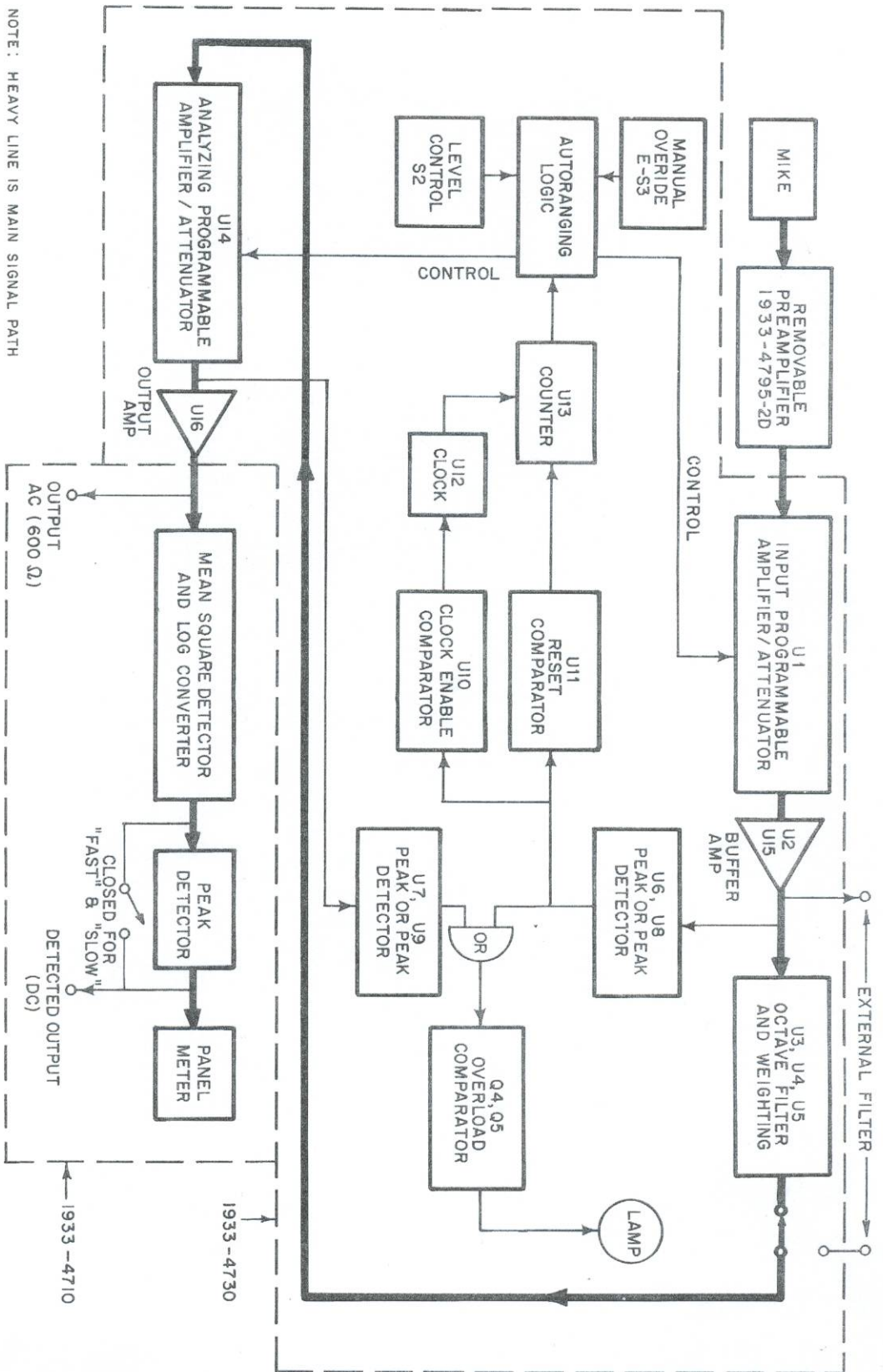

1933 PRECISION SOUND LEVEL METER AND ANALYZER BLOCK DIAGRAM

1933-8X

Figure 5-3. Overall block diagram for 1933. Parts & Diag 5-5

ELECTRICAL PARTS LIST

Ref Des	Description	GR Part No.	Fed Mfg Code	Mfg Part No.	Fed Stock No.
CHASSIS-MOUNTED PARTS					
CAPACITORS					
A-C1	Tantalum Non-Polar, 2.3 μ F 10 V	4450-5803	80183	2.3 μ F 10 V	
CONNECTORS					
	Connector	1933-0400	24655	1933-0400	
	Connector Panel	1933-7090	24655	1933-9091	
A-J1 thru					
A-J4	Miniature	4260-1110	24655	4260-1110	
A-J5	Mult. Socket, 9 Cont.	4260-1110	24655	4260-1110	
METER					
A-M1	Meter ass'y	5730-1933	24655	5730-1933	
RESISTORS					
A-R13	Comp., 10 Ω	6099-0105	75042	BTS, 10 Ω \pm 5%	5905-809-8596
A-R15	Comp., 510 Ω	6099-1515	75042	BTS, 510 Ω \pm 5%	5905-801-8272
SWITCHES					
A-S1	Switch, Toggle, 2 Pos., SPDT	7910-0460	71744	23-021-109	
BATTERY					
A-BT1	Battery (4 req'd)	8410-1500	09823	1810	
EARPHONES					
		1935-0410	24655	1935-0410	
MICROPHONES					
	(1" Dia Random)	1961-3000	24655	1961-3000	
	(1" Dia Perpendicular)	1961-3100	24655	1961-3100	
	1/2" Random	1962-3000	24655	1962-3000	
	1/2" Perpendicular	1962-3100	24655	1962-3100	

ELECTRICAL PARTS LIST

Ref Des	Description	GR Part No.	Fed Mfg Code	Mfg Part No.	Fed Stock No.
Main Circuit Board - P/N 1933-4730					
CAPACITORS					
C1 and					
C2	Tantalum, 4.7 μ F	4450-4700	56289	150D465X0015B2	5910-813-8160
C3	Ceramic, .20 pF	4404-0208	72982	831, .20 pF \pm 5%	
C4	Plastic, .006355 μ F	4862-1700	19396	PCR700	
C5	Plastic, .06355 μ F	4862-1860	19396	PCR700	
C6	Plastic, .006355 μ F	4862-1700	19396	PCR700	
C7 and					
C8	Plastic, .04264 μ F	4862-1820	19396	PCR700	
C9 and					
C10	Plastic, .0096 μ F	4862-1780	19396	PCR700	
C11	Plastic, .096 μ F	4862-2000	19396	PCR700	
C12 and					
C13	Cap. Ceramic, 0.1 μ F +80-20% 100 V	4403-4100	80131	CC63, .1 μ F +80-20%	5910-974-5699
C14 and					
C15	Cap. Ceramic, .01 μ F +80-20% 100 V	4401-3100	80131	CC61, .01 μ F +80-20%	5910-974-5697
C16 and					
C17	Plastic, .047 μ F	4860-9473	84411	663UW, .047 μ F	
C18 thru					
C21	Ceramic, .30 pF	4404-0305	72982	831, .30 pF \pm 5%	
C22	Plastic, .047 μ F	4860-9473	84411	663UW, .047 μ F	
C23	Tantalum, .47 μ F	4450-4310	72982	831, .47 μ F	
C24	Ceramic, .001 μ F	4404-2108	72982	831, .001 μ F	
C25 thru					
C27	Ceramic, .01 μ F	4401-3100	80131	CC61, .01 μ F +80-20%	5910-974-5697
C28 and					
C29	Tantalum, 47 μ F	4450-5712	37942	MTP	
C30 and					
C31	Tantalum, 4.7 μ F	4450-4700	56289	150D465X0015B2	5910-813-8160
C32 and					
C33	Ceramic, .001 μ F	4404-2108	72982	831, .001 μ F	
C34 and					
C35	Ceramic, .01 μ F	4401-3100	80131	CC61, .01 μ F +80-20%	5910-974-5697
C36	Cap. Ceramic, 0.47 μ F \pm 10% 50 V	4400-6358	09392	8141-M050-W5R473K	
C37 and					
C38	Ceramic, 1 μ F	4400-2070	80183	5C13, .1 μ F \pm 20%	5910-083-6445
C39	Tantalum, 300 μ F	4450-5724	37942	TT, 300 μ F	
C40	Tantalum, 80 μ F	4450-6300	37942	TT, 80 μ F	
C42	Ceramic, .01 μ F	4401-3100	80131	CC61, .01 μ F +80-20%	5910-974-5697
C43	Cap. Ceramic, 5.1 pF \pm 5% 500 V	4411-9515	80131	CC60, 5.1 pF \pm 5%	
C44	Ceramic, 120 pF	4404-1128	72982	831, 120 pF	
C45	Tantalum, 47 μ F	4450-5500	56289	150D476X0006B2	5910-752-4185
C46	Ceramic, .120 μ F	4404-1128	72982	831, .120 μ F	
C47	Tantalum, 4.7 μ F	4450-4700	56289	150D465X0015B2	5910-813-8160
C48 and					
C49	Cap. Ceramic, 30 pF \pm 5% 500 V	4404-0305	72982	831, 30 pF \pm 5%	
C50	Cap. Ceramic, 10 pF \pm 10% 500 V	4404-0108	72982	831, 10 pF \pm 10%	
C51	Cap. Ceramic, 82 pF \pm 10% 500 V	4404-0828	72982	831, 82 pF \pm 10%	
C52	Cap. Tant., 4.7 μ F \pm 20% 10 V	4450-4700	56289	150D465X0015B2	5910-813-8160
CHOKES					
L1 thru					
L3	Shielded, 56 μ H \pm 10%	4300-6390	99800	3500, 56 μ H \pm 10%	5950-410-3879
L4	Shielded, 18,000 μ H \pm 10%	4300-6704	99800	3500, 18,000 μ H \pm 10%	
DIODES					
CR1 thru					
CR10	Type 1N4009	6082-1012	24446	1N4009	5961-892-8700
CR11 thru					
CR22	Type 1N995	6082-1002	80368	1N995	5961-893-6762
CR24 and					
CR25	Type 1N4009	6082-1012	24446	1N4009	5961-892-8700
CR27 thru					
CR30	Type 1N455	6082-1010	07910	1N455	5960-877-8255
VR1	Type 8.4 V	6083-1097	12498	TD333627	
VR2	Type 1N746, 3.3 V	6083-1005	07910	1N746	5960-984-3570
INTEGRATED CIRCUITS					
U1	Program Amp/Atten. Hybrid	1933-0840	24655	1933-0840	
U2	Linear, Type LM 101A	5432-1020	12040	LM 101A	
U3 thru					
U5	Linear, Type HA -2911	5432-1031	12040	HA -2911	
U6 and					
U7	Peak Detector Amplifier Hybrid	1933-0830	24655	1933-0830	
U8 thru					
U11	Linear, Type LM 308H	5432-1030	12040	LM 308H	
U12	Digital Type CD4011E	5431-7000	79089	CD4011AE	
U13	Digital, Type CD4017E	5431-7001	79089	CD4017AE	
U14	Program Amp/Atten. Hybrid	1933-0840	24655	1933-0840	
U15	4 Channel MOS Switch (MM551)	5434-0109	42498	MM551	
U16	Linear, Type LM 301A	5432-1004	12040	LM301A	

ELECTRICAL PARTS LIST (cont)

Ref Des	Description	GR Part No.	Fed Mfg Code	Mfg Part No.	Fed Stock No.
RESISTORS					
R1A and					
R1B	Comp., 4.3 M Ω to 6.2 M Ω *	6099-	24655		
R2	Pot. Cermet, 10 k Ω	6049-0360	80294	3329W	
R3	Comp., 16 k Ω	6099-3165	75042	BTS, 16 k Ω \pm 5%	
R4 thru					
R6	Comp., 47 k Ω	6099-3475	75042	BTS, 47 k Ω \pm 5%	5905-683-2246
R7	Pot. Cermet, 20 k Ω	6049-0110	24655	6049-0110	
R8	Comp., 5.6 k Ω	6099-2565	75042	BTS, 5.6 k Ω \pm 5%	
R9	Pot. Cermet, 20 k Ω	6049-0110	24655	6049-0110	
R10	Comp., 5.6 k Ω	6099-2565	75042	BTS, 5.6 k Ω \pm 5%	
R11	Comp., 6.2 k Ω	6099-2625	75042	BTS, 6.2 k Ω \pm 5%	
R12	Pot. Cermet, 5 k Ω	6049-0108	98474	597040	
R13	Comp., 6.2 k Ω	6099-2625	75042	BTS, 6.2 k Ω \pm 5%	
R14	Film, 909 Ω	6250-0909	75042	CEA, 909 Ω \pm 1%	
R15	Pot. Cermet, 200 Ω	6049-0104	98474	597020	
R16	Film, 10.0 k Ω	6250-2100	75042	CEA, 10.0 k Ω \pm 1%	5905-883-4847
R17	Film, 909 Ω	6250-0909	75042	CEA, 909 Ω \pm 1%	
R18	Pot. Cermet, 200 Ω	6049-0104	98474	597020	
R19	Film, 10.0 k Ω	6250-2100	75042	CEA, 10.0 k Ω \pm 1%	5905-883-4847
R20	Film, 15.0 k Ω	6250-2150	75042	CEA, 15.0 k Ω \pm 1%	5905-581-7626
R21	Film, 58.8 k Ω	6250-2588	75042	CEA, 58.8 k Ω \pm 1%	
R22	Film, 2.29 k Ω	6250-1229	75042	CEA, 2.29 k Ω \pm 1%	5905-855-3176
R23	Pot. Cermet, 500 Ω	6049-0105	98474	62TR500	
R24	Film, 10.0 k Ω	6250-2100	75042	CEA, 10.0 k Ω \pm 1%	5905-883-4847
R25	Film, 76.8 k Ω	6250-2768	75042	CEA, 76.8 k Ω \pm 1%	
R26	Film, 4.75 k Ω	6250-1475	75042	CEA, 4.75 k Ω \pm 1%	
R27	Film, 19.0 k Ω	6250-2190	75042	CEA, 19.0 k Ω \pm 1%	
R28	Comp., 47 M Ω	6099-6475	75042	BTS, 47 M Ω \pm 5%	5905-683-2246
R29 and					
R30	Comp., 10 k Ω	6099-3105	75042	BTS, 10 k Ω \pm 5%	5905-683-2238
R31	Comp., 47 M Ω	6099-6475	75042	BTS, 47 M Ω \pm 5%	5905-683-2246
R32	Film, 84.5 k Ω	6250-2845	75042	CEA, 84.5 k Ω \pm 1%	
R33	Film, 6.34 k Ω	6250-1634	75042	CEA, 6.34 k Ω \pm 1%	
R34	Film, 56.2 k Ω	6250-2562	75042	CEA, 56.2 k Ω \pm 1%	
R35	Film, 34.8 k Ω	6250-2348	75042	CEA, 34.8 k Ω \pm 1%	5905-892-6968
R36	Comp., 10 k Ω	6099-3105	75042	BTS, 10 k Ω \pm 5%	5905-683-2238
R37	Comp., 24 k Ω	6099-3245	75042	BTS, 24 k Ω \pm 5%	
R38	Film, 9.09 k Ω	6250-1909	75042	CEA, 9.09 k Ω \pm 1%	5905-655-3167
R39	Comp., 510 k Ω	6099-4515	75042	BTS, 510 k Ω \pm 5%	5905-801-8272
R40	Comp., 300 k Ω	6099-4305	75042	BTS, 300 k Ω \pm 5%	5905-681-8854
R41	Film, 18.0 k Ω	6250-2180	75042	CEA, 18.0 k Ω \pm 1%	5905-686-3373
R42	Comp., 1 k	6099-2105	75042	BTS, 1 k Ω \pm 5%	5905-681-6422
R44	Comp., 4.7 M Ω	6099-5475	75042	BTS, 4.7 M Ω \pm 5%	5905-686-9992
R45	Comp., 2.2 M Ω	6099-5225	75042	BTS, 2.2 M Ω \pm 5%	5905-723-5251
R46	Comp., 510 k Ω	6099-4515	75042	BTS, 510 k Ω \pm 5%	5905-801-8272
R47	Pot. Cermet, 500 k Ω	6049-0114	80294	3329H-1-304	
R48 thru					
R55	Comp., 100 k Ω	6099-4105	75042	BTS, 100 k Ω \pm 5%	5905-686-3129
R56	Comp., 1 M Ω	6099-5105	75042	BTS, 1 M Ω \pm 5%	
R57A and					
R57B	Comp., 4.3 M Ω to 6.2 M Ω *	6099-	24655		
R58 and					
R59	Comp., 1.5 k Ω	6099-2155	75042	BTS, 1.5 k Ω \pm 5%	
R60	Comp., 470 Ω	6099-1475	75042	BTS, 470 Ω \pm 5%	5905-683-2242
R61	Comp., 10 k Ω	6099-3105	75042	BTS, 10 k Ω \pm 5%	5905-683-2238
R62	Comp., 4.3 k Ω	6099-2435	75042	BTS, 4.3 k Ω \pm 5%	
R63	Comp., 11 k Ω	6099-3115	75042	BTS, 11 k Ω \pm 5%	
R64	Comp., 100 k Ω	6099-4105	75042	BTS, 100 k Ω \pm 5%	5905-686-3129
R65	Comp., 4.7 M Ω	6099-5475	75042	BTS, 4.7 M Ω \pm 5%	5905-686-9992
R67 and					
R68	Comp., 2 k Ω	6099-2205	75042	BTS, 2 k Ω \pm 5%	5905-686-3370
R69	Comp., 47 k Ω	6099-3475	75042	BTS, 47 k Ω \pm 5%	5905-683-2246
R70	Film, 9.09 k Ω	6250-1909	75042	CEA, 9.09 k Ω \pm 1%	5905-655-3167
R71	Film, 1.58 k Ω	6250-1158	75042	CEA, 1.58 k Ω \pm 1%	5905-755-0677
R72	Comp., 620 Ω	6099-1625	75042	BTS, 620 Ω \pm 5%	5905-801-6998
RESISTOR NETWORKS					
Z1 and					
Z2	Resistor Network	1933-0800	24655	1933-0800	
Z3	Resistor Network	1933-0820	24655	1833-0820	
Z4	Resistor Network	1933-0810	24655	1933-0810	
Z5	Resistor Network	1933-0820	24655	1933-0820	
Z6	Resistor Network	1933-0810	24655	1933-0810	

*Value to be selected by lab

ELECTRICAL PARTS LIST (cont)

Ref Des	Description	GR Part No.	Fed Mfg Code	Mfg Part No.	Fed Stock No.
SWITCHES					
S1	Switch Rotary	7890-5584	79089	SERIES-160	
S2	Rotary	7890-5585	79089	SERIES-160	
TERMINALS					
	EC Test Point	7970-2600	24655	7970-2600	
TRANSFORMER					
T1		1933-2110	24655	1933-2110	
TRANSISTORS					
Q2 thru					
Q4	Type 2N4250	8210-1135	93916	2N4250	
Q5	Type 2N4384	8210-1131	93916	2N4384	
Q6 thru					
Q13	Type 2N3391A	8210-1092	24454	2N3391A	
Q14 and					
Q15	Type 2N3414	8210-1047	75491	2N3414	
Q16	Type 2N5190	8210-1196	93916	2N5190	
Q17	Type 2N4250	8210-1135	93916	2N4250	
Q18 and					
Q19	Type 2N3391A	8210-1092	24454	2N3391A	

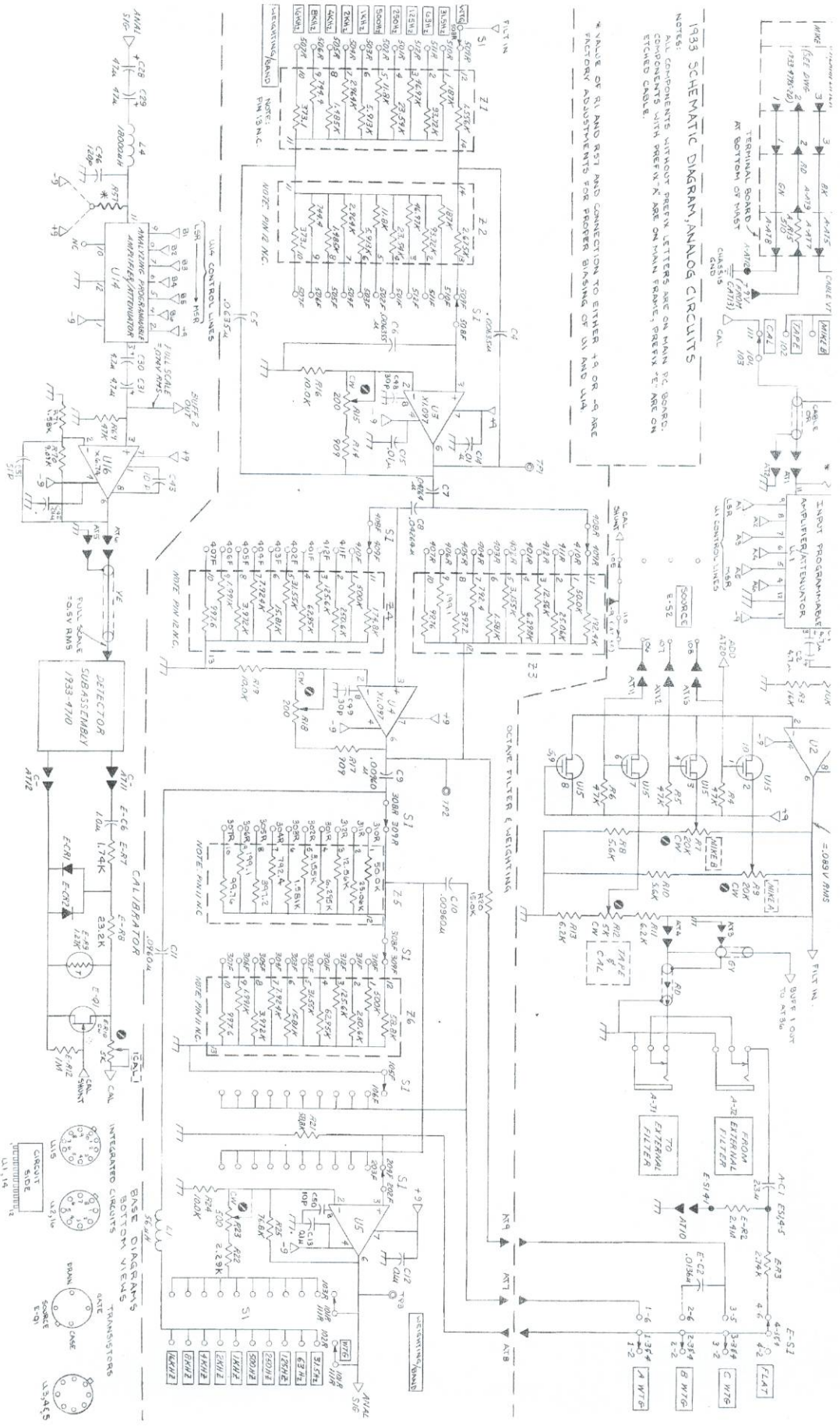

1933 SCHEMATIC DIAGRAM, ANALOG CIRCUITS

NOTES:
 ALL COMPONENTS WITHOUT PREFIX LETTERS ARE ON MAIN P.C. BOARD.
 ALL COMPONENTS WITH PREFIX X ARE ON MAIN FRAME, PREFIX Y ARE ON
 STICED CARDS.

* VALUE OF R1 AND R51 AND CONNECTION TO EITHER +9 OR -9 ARE
 FACTORY ADJUSTMENTS FOR PROPER BIASING OF U1 AND U14

Figure 5-5. Schematic diagram for 1933 analog circuits.
Parts & Diag 5-7

ELECTRICAL PARTS LIST

Ref Des	Description	GR Part No.	Fed Mfg Code	Mfg Part No.	Fed Stock No.
Etched Cable - P/N 1933-4740					
CAPACITORS					
C2	Plastic, .0136 μ F	4862-1790	19396	PCR700	
C6	Ceramic, 1 pF	4400-2070	80183	5C13, 1 μ F \pm 20%	5910-083-6445
DIODES					
CR1 and CR2	Type 1N4154 or 1N4009	6082-1012	24446	1N4009	5961-892-8700
LAMPS					
DS1	Incandescent, 5 V	5600-1300	24655	5600-1300	
RESISTORS					
R2	Comp., 2.4 M Ω	6099-5245	75042	BTS, 2.4 M Ω \pm 5%	
R3	Film, 2.74 k Ω	6250-1274	75042	CEA, 2.74 k Ω \pm 1%	5905-834-7208
R7	Res. Film, 1.74 k Ω \pm 1% 1/8 W	6250-1174	75042	CEA, 1.74 k Ω \pm 1%	
R8	Res. Film, 23.2 k Ω \pm 1% 1/8 W	6250-2232	75042	CEA, 2.32 k Ω \pm 1%	
R9	W.W., 1.27 k Ω \pm 2%	6620-1041			
R10	Pot	6049-0297	01121	2H5021	
R12	Comp., 1 M Ω	6099-5105			
SWITCHES					
S1	Pushbutton	7880-2110	71590	PB-15	
S2	Rot. Waf	7890-8290	76854	7890-8290	
S3	Rot. Waf	7890-8291	76854	7890-8291	
TRANSISTORS					
Q1	Type E-113	8210-1229	23136	E-113	

INTER CONNECTIONS (FOR LOG REFERENCE ONLY)

MAIN BD TERM	DETECTOR DD TERM	E-S1 SECT TERM	E-S2 TERM	E-S3 TERM	MISC CONNECTION	FUNCTION	DETECTOR DD TERM	E-S1 SECT TERM	E-S2 TERM	MISC CONNECTION	FUNCTION	
22	15					-9V	1	5	6		} BAT CK	
24	13					+9V	2	5	4			
25	10, 12, 14					SIGNAL GND	3	5	2			
26	9					LMPI	5	5	3			
27	8	B	5+6			+6V SWITCHED	4	6	6		IMP	
28				104		} MANUAL OVERRIDE SWITCHING	6	7	6		SLOW	
29				107			7	7	4		} SIGNAL GND	
30				108				6	3+4			
31				109		} CALC CTS OF PUMPER	11	5	5		CAL INPUT	
32				110				B	3		BAT +	+6V (UNSWITCHED)
33				111					105		CALC CTS GATE	CAL SHUNT
34				112					111		CALC CTS SOURCE TO E-RIO	CAL
35				110	101	-9V						
	23				E-D51	OVERLOAD IMP						
	26											

ELECTRICAL PARTS LIST

Ref Des	Description	GR Part No.	Fed Mfg Code	Mfg Part No.	Fed Stock No.
Preamplifier Board - P/N 1933-4795.					
CAPACITORS					
C1	Ceramic, .001 μ F $\pm 10\%$ 200 V	4400-6440	72982	8121-026-Y5RO-102K	
C2	Tantalum, 6.8 μ F $\pm 20\%$ 15 V	4450-6401	24655	4450-6401	
C3	Tantalum, 1.0 μ F $\pm 20\%$ 35 V	4450-6400	56289	162-D	
CONNECTORS					
P1	Threaded coaxial				
P2	Microphone, 4 term	1933-0410	24655	1933-0410	
RESISTORS					
R1	Res., Comp., 2.2 G $\pm 20\%$ 1/8 W	6098-8228	01121	BB, 2.2 G $\pm 20\%$	
R2	Res., Comp., 22 Ω $\pm 5\%$ 1/8 W	6098-0225	01121	BB, 22 Ω $\pm 5\%$	
R3	100 k Ω $\pm 5\%$ 1/8 W	6098-4105	01121	BB, 100 k Ω $\pm 5\%$	
R4	{ 12 k Ω $\pm 5\%$ 1/8 W For 6.2 k Ω $\pm 5\%$ 1/8 W Q1 3.3 k Ω $\pm 5\%$ 1/8 W IDSS	6098-3125	01121	BB, 12 k Ω $\pm 5\%$	
		6098-2625	01121	BB, 6.2 k Ω $\pm 5\%$	
		6098-2335	01121	BB, 3.3 k Ω $\pm 5\%$	
R5	Comp., 4.7 k Ω $\pm 5\%$ 1/8 W	6098-2475	01121	BB, 4.7 k Ω $\pm 5\%$ 1/8 W	
R6	100 k Ω $\pm 5\%$ 1/8 W	6098-4105	01121	BB, 100 k Ω $\pm 5\%$	
R7	Comp., 3.0 k Ω $\pm 5\%$ 1/8 W	6098-2305	01121	BB, 3.0 k Ω $\pm 5\%$	
R8	Comp., 20 Ω $\pm 5\%$ 1/8 W	6098-0105	01121	BB, 10 Ω $\pm 5\%$ 1/8 W	
TRANSISTORS					
Q1	Type 2N3457	8210-1082	17856	2N3457	
Q2	Type D30A3	8210-1204	24454	D30A3	

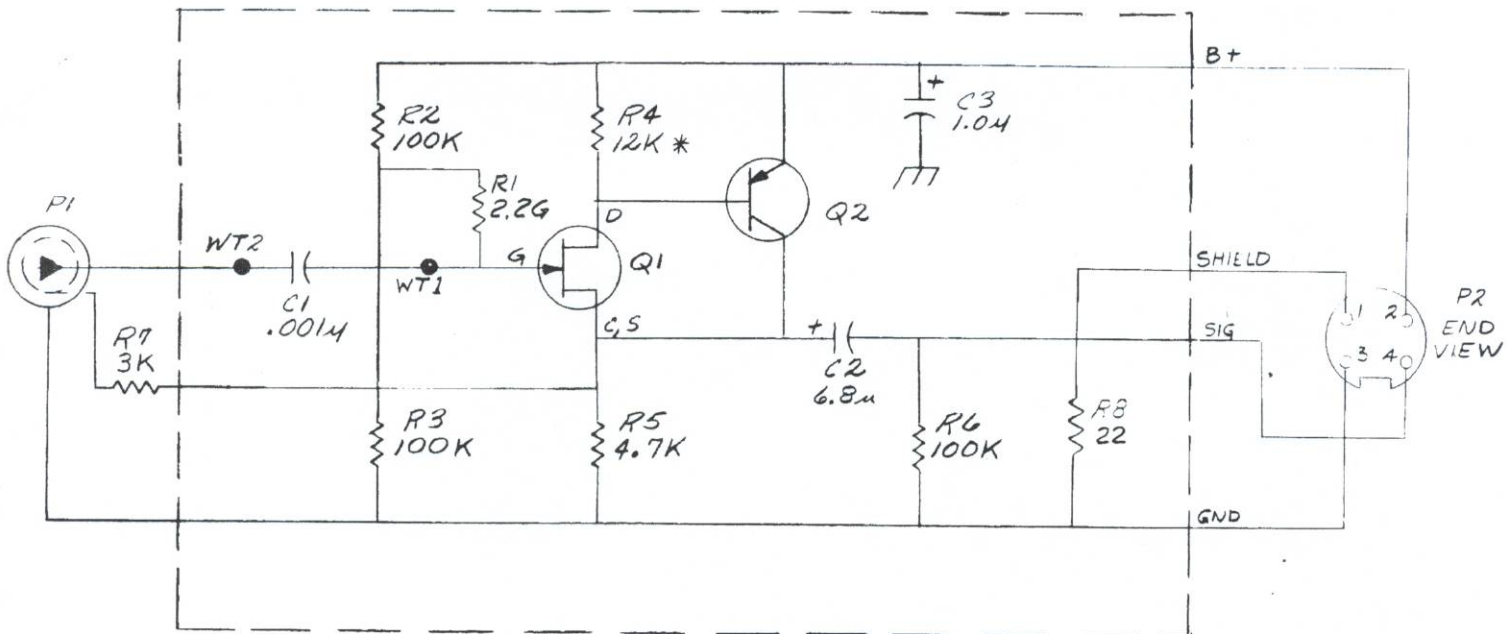

TRANSISTOR
BASE DIAGRAMS

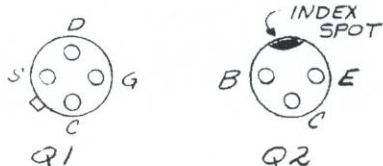

* LAB SELECTED

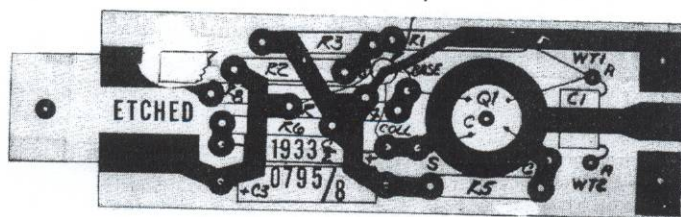
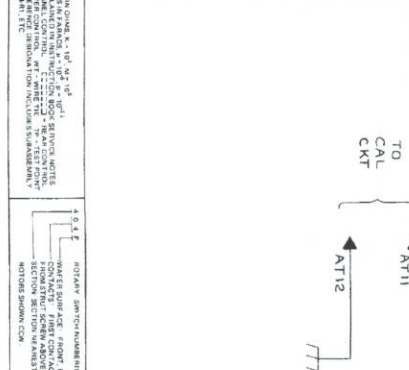
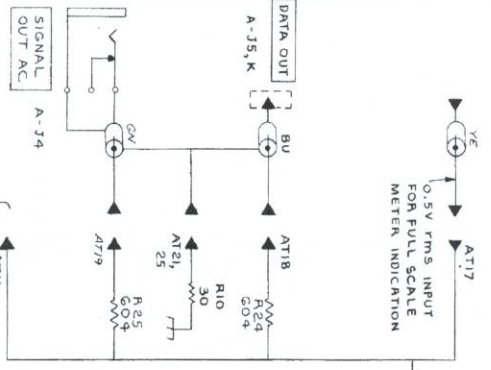
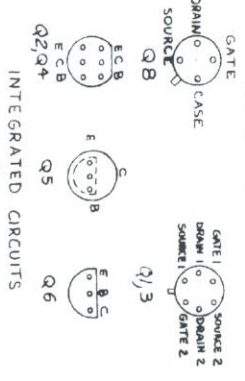

Figure 5-8. Etched-circuit board for removable preamplifier assembly, P/N 1933-4795.

ELECTRICAL PARTS LIST

Ref Des	Description	GR Part No.	Fed Mfg Code	Mfg Part No.	Fed Stock No.
Detector Board - P/N 1933-4710					
CAPACITORS					
C5	Tantalum, 0.33 μ F, $\pm 10\%$, 75 DCWV	4450-4290	56289	.33 μ F, $\pm 10\%$, 75 DCWV	
C6	Tantalum, 56 μ F, $\pm 10\%$, 26 DCWV	4450-5520	56289		
C8	Mylar, .18 μ F	4860-9474	84411	663UW, .18 μ F	
C9	Ceramic, 30 pF	4404-0305	72982	831, 30 pF	
C11 and C12	Ceramic, .01 μ F	4401-3100	80131	CC61, .01 μ F, $\pm 80-20\%$	5910-974-5697
C15	Ceramic, 0.1 μ F, $\pm 80-20\%$, 100 DCWV	4403-4100			
C17	Tantalum, 1 μ F	4450-4300			
CONNECTORS					
	Jack, .062 Bd, Ec	4260-0850	22526	47330	
DIODES					
CR10	1N3604	6082-1001			
INTEGRATED CIRCUITS					
U2	Linear (LM308 H)	5432-1030	12040	LM308H	
RESISTORS					
R4	Pot. Cermet, 10 k Ω	6049-0109	80294		
R10	Comp., 30 Ω	6099-0305	75042	BTS, 30 Ω , $\pm 5\%$	
R11	Comp., 47 M Ω	6099-6475	75042	BTS, 47 M Ω , $\pm 5\%$	
R15	Film, 15.4 M	6350-5154	75042	CEA, 15.4 M Ω , $\pm 1\%$	
R16	Thermistor, 1.27 k Ω , $\pm 2\%$	6620-1041			
R17	Film, 19.6 k Ω	6250-2196			
R18	Film, 47.5 k Ω	6250-3475	75042	CEA, 4.75 k Ω , $\pm 1\%$	5905-646-5681
R19	Film, 27.4 k Ω	6250-2274			
R20	Film, 10.5 k Ω	6250-2105			
R21	Film, 59.0 k Ω	6250-2590	75042	CEA, 59.0 k Ω , $\pm 1\%$	
R22	Comp., 10 k Ω	6099-3105	75042	BTS, 10 k Ω , $\pm 5\%$	5905-683-2238
R23	Film, 4.49 k Ω	6250-1449	75042	CEA, 4.49 k Ω , $\pm 1\%$	
R24 and R25	Film, 604 Ω	6250-0604	75042	CEA, 604 Ω , $\pm 1\%$	
R26	Comp., 6.8 k Ω	6099-2685	75042	BTS, 6.8 k Ω , $\pm 5\%$	5905-686-9997
R27	Pot. Cermet, 500 k Ω	6049-0114	80294		
R28	Film, 383 k Ω	6250-3383	75042	CEA, 383 k Ω , $\pm 1\%$	
R29 and R30	Film, 15.4 k Ω	6250-2200	75042	CEA, 20.0 k Ω , $\pm 1\%$	5905-702-5971
R31	Film, 22.6 k Ω	6250-2226	75042	CEA, 22.6 k Ω , $\pm 1\%$	5905-683-5747
R32	Film, 2.1 k Ω	6250-1332	75042		
R33 and R34	Film, 19.1 k Ω	6250-2191	75042	CEA, 19.1 k Ω , $\pm 1\%$	
R35	Comp., 1 k Ω	6099-2105	75042	BTS, 1 k Ω , $\pm 5\%$	5905-681-6422
R36	Pot. Cermet, 10 k Ω	6049-0109	80740	34331210	
R37	Pot., 1 k Ω	6049-0106			
R39	Film, 7.96 k Ω , 1/8 W, $\pm 1\%$	6250-1796			
R40	Film, 113 k Ω ,	6250-3113			
R42	Comp., 1 M Ω	6099-5105			
TRANSISTORS					
Q3	Type DN252	8210-1164	17856	DN252	
Q4	Type TD400	8210-1169	56289	TD400	
Q5	Type 2N3391A	8210-1092	17856	2N3457	
Q6	Type 2N4125	8210-1125	04713	2N4125	
Q8	Type 2N4416	8210-1142		2N4416	

BASE DIAGRAMS
(BOTTOM VIEWS)
TRANSISTORS



WAVEFORM CONDITIONS:
1KHZ, 0.5VPP, -3dB(0.355V)
AT INPUT (AT17)
WEIGHTING, FLAT, PEAK MODE

SECTION

1	2	3	4	5	6	7	8
A	B	C	D	E	F	G	H

FUNCTION

TOP VIEW

PEAK IMPULSE A-51

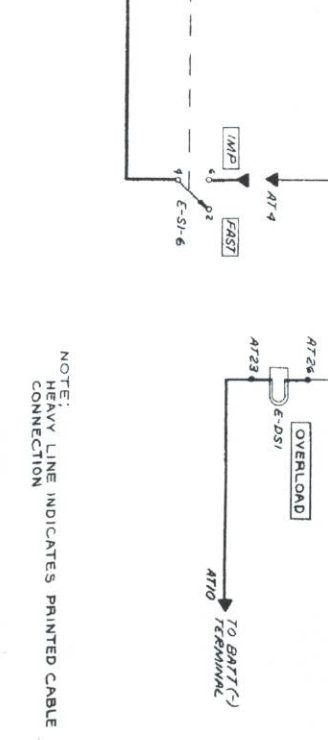
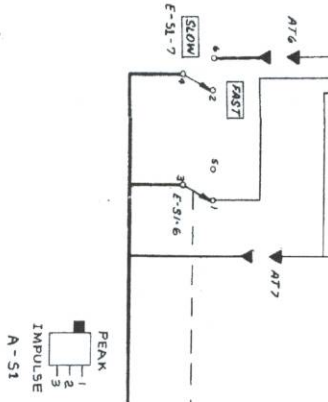

NOTE:
HEAVY LINE INDICATES PRINTED CABLE CONNECTION

Figure 5-12. Schematic diagram for 1933 detector and meter output circuits.

GR 1940 POWER SUPPLY and CHARGER

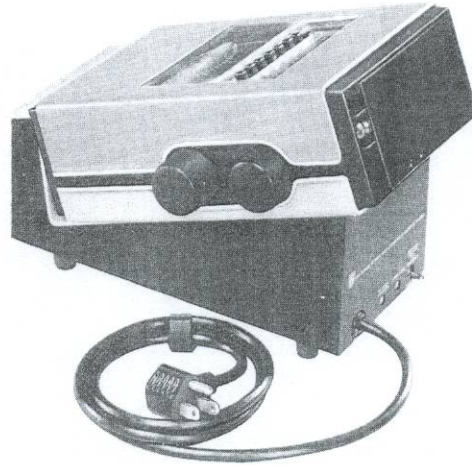

Figure 1. Type 1940 Power Supply and charger shown with GR 1933 installed.

SPECIFICATIONS

Power Source: 5 V for line operation of 1933, 6.5 V for line operation of 1935; 250 mA max.

Charging Source: 200 mA max for charging batteries in 1933 or 1935; automatically reduces to \approx 30-mA trickle charge when batteries are charged. Charging time \approx 16 h.

Supplied: 5 rechargeable nickel-cadmium C cells to replace non-rechargeable batteries in 1933 or 1935.

Power: 100 to 125 or 200 to 250 V, 50 to 400 Hz, 11 W.

Mechanical: DIMENSIONS (wxhxd): 4.38x4.25x9.44 in. (111x108x240 mm). WEIGHT: 3.5 lb (1.5 kg) net, 5 lb (2.3 kg) shipping.

Description	Catalog Number
1940 Power Supply and Charger	1940-9701

INTRODUCTION.

The 1940 Power Supply and Charger includes two independent sources, a power source and a charging source. The power source provides for line operation of either the 1933 Precision Sound-Level Meter and Analyzer or the 1935 Cassette Data Recorder, completely independent of the instrument's batteries. It operates from line voltages between 100-125 and 200-250-V, 50-400 Hz. The charging source charges the batteries in either instrument.

It is supplied with five rechargeable cells (to replace the ordinary C cells supplied in the analyzer or recorder).

OPERATION.

There are no internal connections to make; the instruments simply plug into the 1940 and are supported at a convenient angle for bench-top operation, (Figure 1).

Dimensions for the unit are shown in Figure 2.

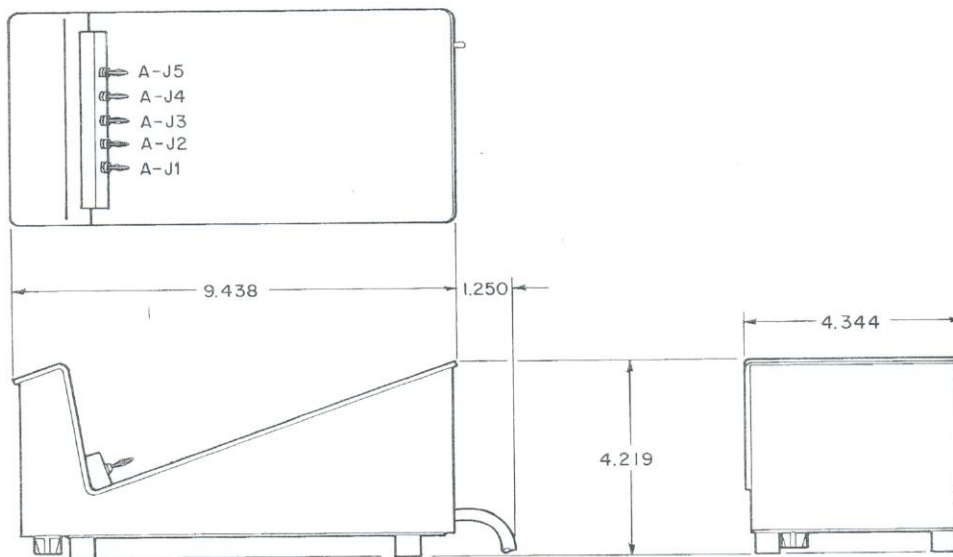

Figure 2.

1940-1

CIRCUIT DESCRIPTION.

See the schematic diagram (Figure 5) for circuits referred to in the following description.

The regulator circuits for both sources are supplied from a common rectifier and filter-capacitor circuit. When the line voltage is applied, the POWER LINE indicator lamp, DS1, lights. It is fed from a constant-current source consisting of transistor Q8, diode CR11, and resistors R16 and R17.

The regulator circuit for the charging source consists of integrated circuit U1 and transistors Q3, Q4, and Q5. Q3 is a FET that operates as a constant-current source for diode VR1, which provides a reference to one input of U1. The other input of U1 is driven from a voltage proportional to the voltage being regulated. U1 controls the base current fed to transistor Q5. When the output current increases, so that the voltage drop across R4 and parallel diodes CR12 and CR13 exceeds 1.2 V, transistor Q4 conducts. This diverts the base current of Q5 and shuts it off. The parallel diodes and R4 limit the current from the collector of Q5 to 200 mA, the required charging current for the nickel-cadmium batteries used in the Analyzer and Recorder.

A charging period of 14-16 hours is required to fully charge batteries. Potentiometer R9 (TRICKLE CHG) sets the trickle charge current, which is approximately 30 mA. The trickle charge is adjusted for Gould Nicad 2.0 SCB batteries; if other batteries are used, the trickle charge must be reset.

Diodes CR6, CR7, and CR8 prevent the interaction of the charging and the power source supplies. For the 1935, only CR6 is used in series with the charging supply, for the 1933, three diodes are used. The two additional diodes in the 1933 line give a voltage drop about equal to that of one battery cell.

Transistors Q1 and Q2 form the BATTERY CHARGED circuit. They sense the voltage drop across the series combination of R4, CR12, and CR13. When the voltage across this network drops below 0.6 V, transistor Q2 is turned off and base current for Q1 is supplied through resistor R2. Q1 is turned on and lights the indicator lamp DS2 (BATTERY CHARGED).

The regulator circuit for the line power source consists of integrated circuit U2 and transistors Q6 and Q7, and functions similarly to the charging supply. The reference for this supply is derived from diode VR1. A voltage drop of 0.6 V, across R11, limits the output current to approximately 250 mA.

Two diodes, CR9 and CR10, in series with the output to the 1933, give a voltage drop about equal to that of one battery cell.

SERVICE AND MAINTENANCE.

Table 1
TEST EQUIPMENT RECOMMENDED

Instrument	Requirements	Recommended*
Wave Analyzer	Continuous, 20 Hz to 54 kHz	GR 1900
Variac® autotransformer, metered	Nominal line voltage of 120 V with meters for amps, volts and watts.	GR W5MT3AW
Volt/Ohmmeter electronic	Voltage range to 250 Vac; ohms range to 10 MΩ.	GR 1806
Oscilloscope	General purpose, low frequency	Tektronix type 547, 1 A 1 plug-in
Ammeter	Dc. 0-500 mA	Commercial
Potentiometer	Wirewound, 0-250 ohms, 10 W	Commercial

*Or equivalent.

Ohmmeter Checks (RX10K)

(Figure 2)

a. With no power applied, set BATT/LINE to 'LINE' and connect the ohmmeter +side to J1.

- b. Check that A-J1 - A-J2 reads 20 kΩ
- A-J1 - A-J3 reads 1 MΩ
- A-J1 - A-J4 reads 1 MΩ
- A-J1 - A-J5 reads 1 MΩ

c. Check that high side of line to low side reads 150 Ω in 100 - 125 V, 500 Ω in 200 - 250 V positions of power switch, A-S2.

d. Set BATT/LINE switch to 'BATT' test for 0 ohms between J3 and J5 and between J2 and J4.

Input Power Check.

Plug the power cord into the Variac and rotate the Variac control slowly to 115 V. The Variac Wattmeter should read between 2 - 3 W. Both BATTERY CHARGED and PWR line lights should be lighted.

Charge Current Check.

Make the following connections:

- 1940 - Line Connect to Variac
- Variac Set for 115 V out
- 1940 Power switch 'Line' operation (down).
- Load (See Fig. 3) Connect load fixture to J1 and J4 of 1940 (J1 is (-) side)

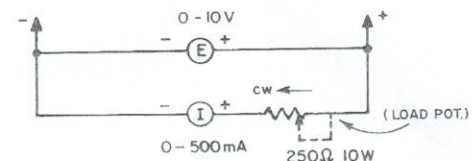

Figure 3.

1940-2

b. Adjust load pot for 35 mA current. Adjust R9 (trickle charge) to give a voltage of 7.1 V across J1/J4.

c. Rotate the load pot cw to give a reading of 5.5 V across J1/J4. The current should be between 190 – 210 mA. Rotate the load pot fully cw. The voltage should drop smoothly to 0 V and the current remain constant at 190 – 210 mA.

d. Move the load fixture to J1 – J5 (J1 is (-)); adjust variable pot for 35 mA. The voltage should read 5.6 – 5.8 V.

e. Adjust the load pot to give a reading of 4.5 V. The ammeter should read 190 – 210 mA. Rotate the load pot fully cw. The voltage should drop smoothly to 0 V and the current remain constant at 190 – 210 mA.

f. Rotate the load pot ccw until the BATTERY CHARGED light comes on. The current should read 110 mA or less. Adjust R9 if required.

Load Current Checks.

a. Connect the load fixture (Figure 3) to J1 (-) and J2. Adjust the load pot until the voltage reads 5.5 V. The current should read 250 – 275 mA. Adjust the load pot fully cw; the voltage should drop smoothly to 0 V and the current remain constant. Set the load pot fully ccw; the voltage should read 6.4 – 6.6 V.

b. Connect the load fixture to J1 (-) and J3 (+). Adjust the load pot until the voltage reads 4.0 V. The current

The voltage should drop smoothly to 0 V and the current remain constant. Set the load pot fully ccw; the voltage should read 5.1 – 5.3 V.

Line Regulation Check

a. Connect the load fixture to the terminals indicated on Table 2. Adjust the load pot for 150 mA in each case. Adjust the Variac output between 95 and 130 Vac. Note the change in voltage at the terminals tested.

b. With the oscilloscope measure the noise at the terminals for the same conditions listed in table 2.

Table 2
LINE REGULATION

Connect Load Fixture to Terminal	Load Current (mA)	Regulation (V)	Ripple (mV)	RMS Hum
				(Each Component) (mV)
- +				
J1 – J2	150	< 0.1	< 10	< 1.5
J1 – J3	150	< 0.1	< 10	< 1.5
J1 – J4	150	< 0.1	< 50	< 1.5
J1 – J5	150	< 0.1	< 50	< 1.5

Hum Check.

Measure the RMS voltage of each component with a 1900 at the conditions listed in Table 2. Measure 60, 120 and 180 Hz.

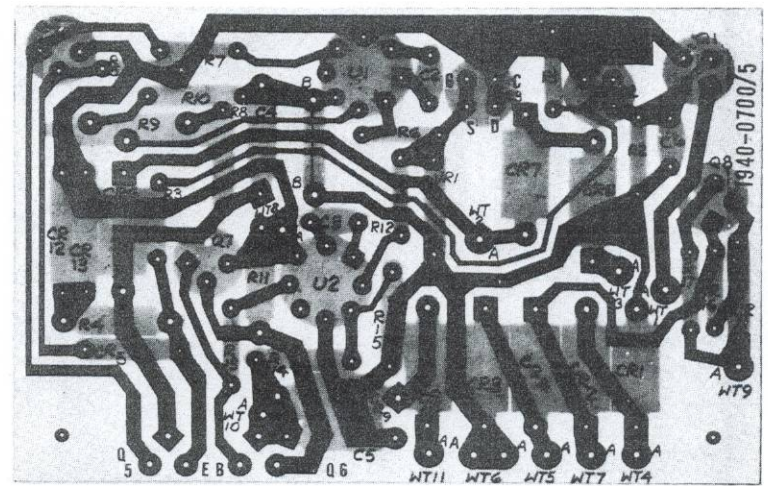
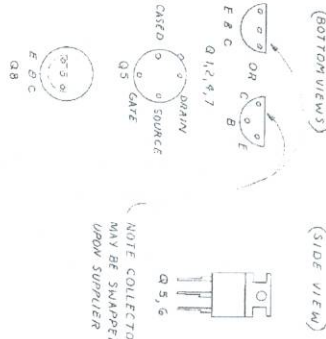

Figure 4. Etched circuit diagram (P/N 1940-4700).

NOTE: *Orientation:* Viewed from foil side. *Part number:* Refer to caption. *Symbolism:* Outlined area = part; gray ckt pattern (if any) = parts side, black = other side. *Pins:* Square pad in ckt pattern = collector, I-C pin 1, cathode (of diode), or + end (of capacitor).

BASE DIAGRAMS
TRANSISTORS



NOTE COLLECTOR & EMITTER
MAY BE SWAPPED DEPENDING
UPON SUPPLIER

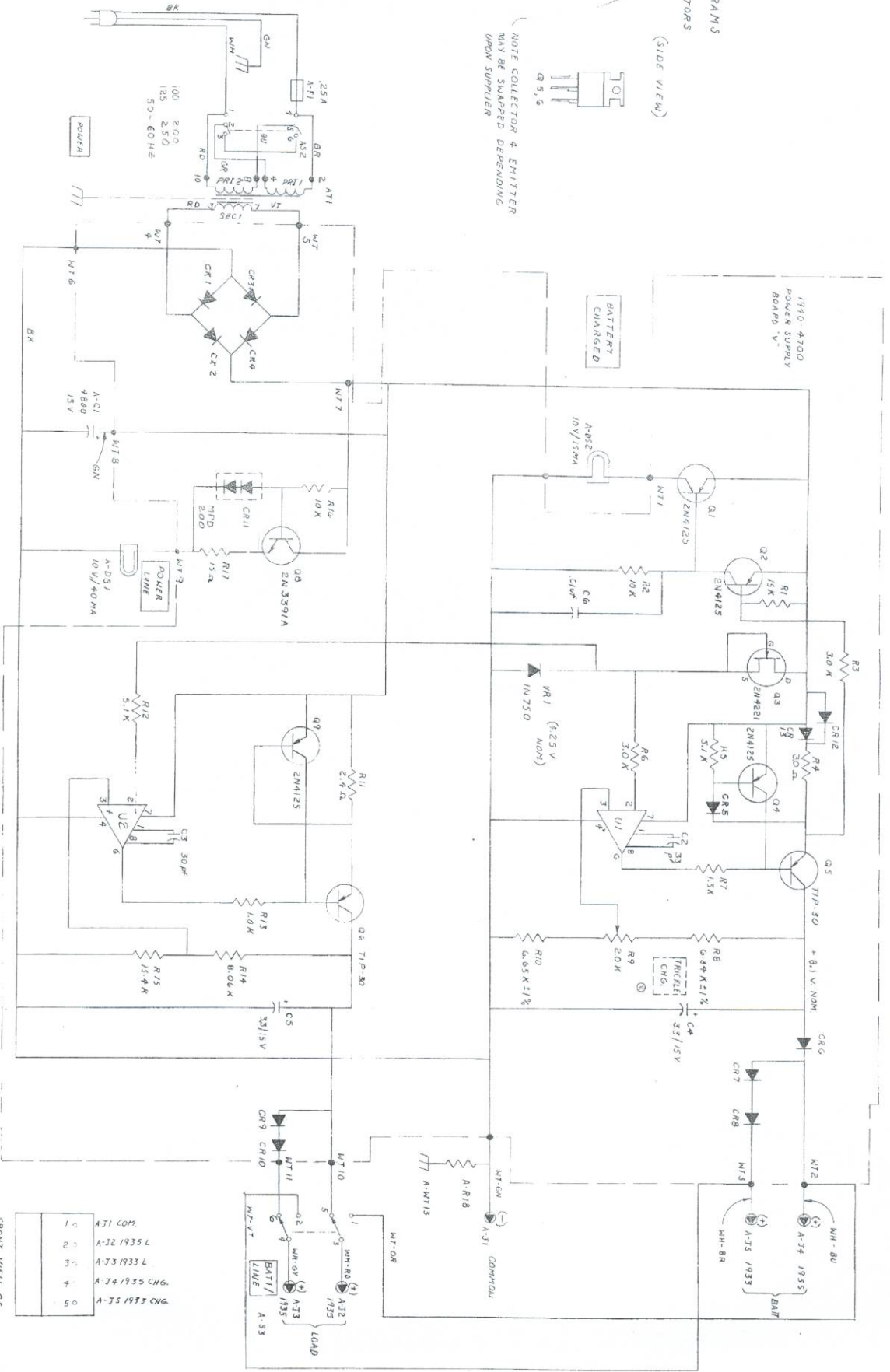

RESISTANCE IS IN OHMS, UNLESS NOTED OTHERWISE.

RESISTOR VALUES: 100, 10K, 100K, 1M, 5M, 10M, 50K, 100K, 150K, 200K, 250K, 300K, 350K, 400K, 450K, 500K, 550K, 600K, 650K, 700K, 750K, 800K, 850K, 900K, 950K, 1M, 1.5M, 2M, 2.5M, 3M, 3.5M, 4M, 4.5M, 5M, 5.5M, 6M, 6.5M, 7M, 7.5M, 8M, 8.5M, 9M, 9.5M, 10M.

CAPACITANCE IS IN MICROFARADS, UNLESS NOTED OTHERWISE.

CAPACITOR VALUES: 100P, 100N, 1000P, 1000N, 10000P, 10000N, 100000P, 100000N, 1000000P, 1000000N, 10000000P, 10000000N, 100000000P, 100000000N, 1000000000P, 1000000000N, 10000000000P, 10000000000N, 100000000000P, 100000000000N, 1000000000000P, 1000000000000N, 10000000000000P, 10000000000000N, 100000000000000P, 100000000000000N, 1000000000000000P, 1000000000000000N, 10000000000000000P, 10000000000000000N, 100000000000000000P, 100000000000000000N, 1000000000000000000P, 1000000000000000000N.

RESISTOR TOLERANCES: ±1%, ±5%, ±10%, ±20%, ±50%, ±100%.

CAPACITOR TOLERANCES: ±5%, ±10%, ±20%, ±50%, ±100%.

RESISTOR CODES: 100, 10K, 100K, 1M, 5M, 10M, 50K, 100K, 150K, 200K, 250K, 300K, 350K, 400K, 450K, 500K, 550K, 600K, 650K, 700K, 750K, 800K, 850K, 900K, 950K, 1M, 1.5M, 2M, 2.5M, 3M, 3.5M, 4M, 4.5M, 5M, 5.5M, 6M, 6.5M, 7M, 7.5M, 8M, 8.5M, 9M, 9.5M, 10M.

CAPACITOR CODES: 100P, 100N, 1000P, 1000N, 10000P, 10000N, 100000P, 100000N, 1000000P, 1000000N, 10000000P, 10000000N, 100000000P, 100000000N, 1000000000P, 1000000000N, 10000000000P, 10000000000N, 100000000000P, 100000000000N, 1000000000000P, 1000000000000N, 10000000000000P, 10000000000000N, 100000000000000P, 100000000000000N, 1000000000000000P, 1000000000000000N.

FRONT VIEW OF PINS

1	A-31 COM.
2	A-32 1935 L
3	A-33 1933 L
4	A-34 1935 CHG.
5	A-35 1933 CHG.

ELECTRICAL PARTS LIST

Ref Des	Description	GR Part No.	Fed Mfg Code	Mfg Part No.	Fed Stock No.
A-C1	Capacitor, 4800 μ F, 15 V	4450-4200	37942	20-21339-99-6	
A-DS1	Lamp, 6 V	5600-0316	71744	# 345	
A-DS2	Lamp, 10 V	5600-0314	71744	# 344	6210-082-0583
A-F1	Fuse, 1/4 A	5330-0700	71400	MDL, 0.25 AMP	5920-933-5435
A-J2-6	Plug Asm	0274-3610	24655	0274-3610	
A-J2-6	Terminal, .138-32	7930-1600	78189	2120-06-00	
A-R18	Resistor, 10 Ω , $\pm 5\%$, 1/2 W	6100-0105	01121	RC20GF100J	5905-190-8883
A-S2	Switch, Slide, DPDT	7910-0832	82389	11A-1118	
A-S3	Switch, Toggle, 2 Pos, DPDT	7910-0791	95146	MST-205N	
A-T1	Transformer Asm	0745-4590	24655	0745-4590	
A-WT12 and A-WT13	Terminal, .112-40	7930-2000			
CAPACITORS					
C2 and C3	Ceramic, 33 pF, $\pm 5\%$, 500 V	4404-0335	72982	831, 33 pF, $\pm 5\%$	
C4 and C5	Tantalum, 3.3 μ F, $\pm 10\%$, 15 V	4450-4601	01295	15335C2	
C6	Ceramic, 0.01 μ F, +80-20%, 100 V	4401-3100	80131	CC61, 0.01 μ F, +80-20%	5910-974-5697
DIODES					
CR1 thru CR4	Type 1N4003	6081-1001	14433	1N4003	
CR5	Type 1N4009	6082-1012	24446	1N4009	5961-892-8700
CR7 and CR8	Type 1N4140	6081-1014	13327	1N4140	
CR9 and CR10	Type 1N4003	6081-1001	14433	1N4003	
CR11	Type MPD200	6082-1033	06751	MPD-200	
CR12 and CR13	Type 1N455	6082-1010	07910	1N455	5960-877-8255
VR1	Type 1N750A	6083-1028	07910	1N750A	5960-754-5897
INTEGRATED CIRCUITS					
U1 and U2	LM301A	5432-1004	12040	LM301A	
RESISTORS					
R1	15 k Ω , $\pm 5\%$, 1/4 W	6099-3155	75042	BTS, 15 k Ω , $\pm 5\%$	5905-681-8818
R2	10 k Ω , $\pm 5\%$, 1/4 W	6099-3105	75042	BTS, 10 k Ω , $\pm 5\%$	5905-683-2238
R3	3 k Ω , $\pm 5\%$, 1/4 W	6099-2305	75042	BTS, 3 k Ω , $\pm 5\%$	5905-682-4097
R4	3.0 Ω , $\pm 5\%$, 1/4 W	6100-9305	01121	EB, 3.0 Ω , $\pm 5\%$	
R5	5.1 k Ω , $\pm 5\%$, 1/4 W	6099-2515	75042	BTS, 5.1 k Ω , $\pm 5\%$	5905-683-2241
R6	3 k Ω , $\pm 5\%$, 1/4 W	6099-2305	75042	BTS, 3 k Ω , $\pm 5\%$	5905-682-4097
R7	1.3 k Ω , $\pm 5\%$, 1/4 W	6099-2135	75042	BTS, 1.3 k Ω , $\pm 5\%$	5905-686-3119
R8	6.34 k Ω , $\pm 5\%$, 1/8 W	6250-1634	75042	CEA, 6.34 k Ω , $\pm 1\%$	
R9	Potentiometer, 2 k Ω , $\pm 10\%$	6051-2209	07999	2600 PC, 2 k Ω , $\pm 10\%$	
R10	6.65 k Ω , $\pm 1\%$, 1/8 W	6250-1665	75042	CEA, 6.65 k Ω , $\pm 1\%$	5905-855-3178
R11	2.4 Ω , $\pm 5\%$, 1/4 W	6100-9245	01121	EB, 2.4 Ω , $\pm 5\%$	
R12	5.1 k Ω , $\pm 5\%$, 1/4 W	6099-2515	75042	BTS, 5.1 k Ω , $\pm 5\%$	5905-683-2241
R13	1 k Ω , $\pm 5\%$, 1/4 W	6099-2105	75042	BTS, 1 k Ω , $\pm 5\%$	5905-681-6422
R14	8.06 k Ω , $\pm 1\%$, 1/8 W	6250-1806	75042	CEA, 8.06 k Ω , $\pm 1\%$	
R15	15.4 k Ω , $\pm 1\%$, 1/8 W	6250-2154	75042	CEA, 15.4 k Ω , $\pm 1\%$	5905-557-3775
R16	10 k Ω , $\pm 5\%$, 1/4 W	6099-3105	75042	BTS, 10 k Ω , $\pm 5\%$	5905-683-2238
R17	15 Ω , $\pm 5\%$, 1/4 W	6099-0155	75042	BTS, 15 Ω , $\pm 5\%$	
SOCKET					
IC8	Cont	7540-3461	09056	7058-295-5	
TRANSISTORS					
Q1 and Q2	Type 2N4125	8210-1125	04713	2N4125	
Q3	Type 2N4221	8210-1127	04713	2N4221	
Q4	Type 2N4125	8210-1125	04713	2N4125	
Q5 and Q6	Type TIP-30	8210-1191	96214	TIP-30	
Q7	Type 2N4125	8210-1125	04713	2N4125	
Q8	Type 2N3391A	8210-1092	24454	2N3391A	