

THE *General Radio* EXPERIMENTER



VOLUME XII NO. 12

MAY, 1938

ELECTRICAL MEASUREMENTS AND THEIR INDUSTRIAL APPLICATIONS

Also IN THIS ISSUE

	Page
EXPERIMENTS IN THE PSYCHOLOGY OF HEARING	3
TYPE 664-A THERMO- COUPLE	7

THE VARIAC TRANSFORMER

● THE VARIAC TRANSFORMER, an adaptation of the Variac principle to give voltage adjustment over narrow ranges, is now available in five stock models. The latest addition to this line is Type 80-C2, a 220-volt model.

The Variac Transformer is built on a rectangular core, with multi-layer windings on the longer two legs of the core. Two carbon brushes make contact with the outside layer on each leg. This straight-line motion is translated into rotary motion by means of a stiff steel tape which winds on a shaft. A 320-degree rotation of this shaft drives the brushes along the entire length of the winding. These details of construction can be seen in the photograph of Figure 1.

Available stock models with their characteristics are listed in the table on page 2. Figure 2 shows the connections. Obviously, input and output connections for the -B and -C models can be reversed, that is,

FIGURE 1. TYPE 70 and TYPE 80 Variac Transformers.

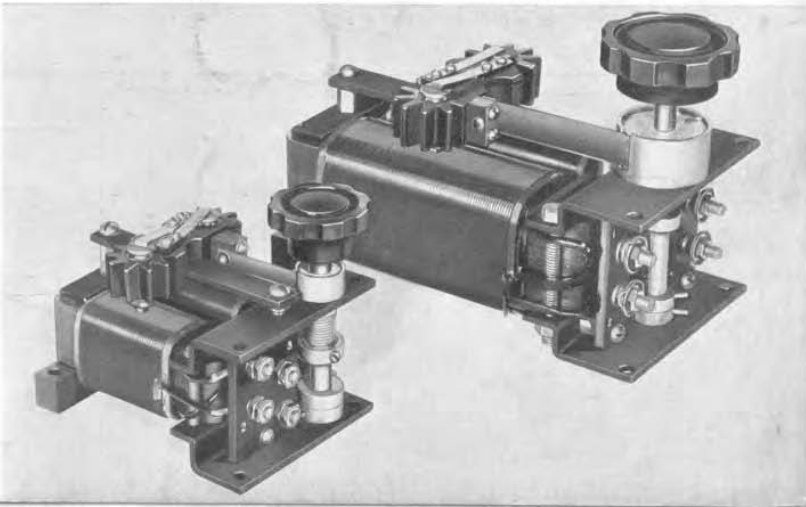

IET LABS, INC in the GenRad tradition
534 Main Street, Westbury, NY 11590

www.ietlabs.com
TEL: (516) 334-5959 • (800) 899-8438 • FAX: (516) 334-5988

Type	Input Volts	Output Volts	Max. Current
70-A2	115	0-10	6 a
70-B2	100-125	115	2 a
80-A2	115	0-10	20 a
80-B2	90-130	115	7.5 a
80-C2	200-240	220	7.5 a

a variable voltage can be obtained from a constant-voltage line, if desired.

Many other combinations of input and output voltages are possible. The limitation on the design of special models is the variation in output power which can be handled by the core structure. This quantity, called "variable power" for want of a better term, is the differ-

ence between the power outputs at maximum and minimum output voltages.

The Type 80 Core will handle 250 watts of variable power, and the Type 70 Core, 50 watts. Variac Transformers designed to the customer's specifications can be supplied within these limits. Prices will gladly be quoted on request.

SPECIFICATIONS

Load Rating: TYPE 70 furnishes 50 watts and TYPE 80 supplies 250 watts of variable power.

Current: See table above. All ratings are for 50- to 60-cycle service.

No-Load Loss: Approximately 5 watts for TYPE 70; 10 watts for TYPE 80.

Terminals: Threaded terminal studs with soldering lugs.

Dimensions: TYPE 70, (length) 4¾ x (width) 3⅝ x (height) 4 inches; TYPE 80, (length) 8½ x (width) 4¼ x (height) 5½ inches, over-all.

Net Weight: TYPE 70, 4¼ pounds; TYPE 80, 13¼ pounds.

Type	Code Word	Price
70-A2	BASIN	\$10.00
70-B2	BASSO	10.00
80-A2	BATON	15.00
80-B2	BATTY	15.00
80-C2	BARON	15.00

The trade name VARIAC is registered at the U. S. Patent Office. The VARIAC is manufactured and sold under U. S. Patent 2,009,013.

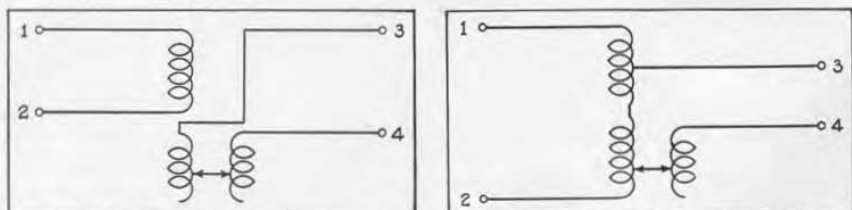

FIGURE 2. (Left) Connections for TYPE 70-A2 and TYPE 80-A2. The input terminals are numbered 1-2; the output terminals 3-4. (Right) Connections for TYPE 70-B2, TYPE 80-B2, and TYPE 80-C2. Input is applied at terminals 3-4 and the output appears at 1-2.



EXPERIMENTS IN THE PSYCHOLOGY OF HEARING

● **MANY GENERAL RADIO INSTRUMENTS** are used by people who are not directly interested in electrical measurements but who have found electrical instruments of some help in studying other phenomena. Accordingly, wave analyzers are bought by soft drink manufacturers, tuning forks are used by geologists, and stroboscopes have been helpful in predicting the effects of earthquakes on structures. Into this category of unusual applications falls the use of many of our instruments by the Department of Psychology of Harvard University. Under the direction of Dr. S. S. Stevens of this department and Dr. Hallowell Davis of the Medical School, a large amount of research has been done on the psychology and physiology of hearing, and in this work electrical instruments have played a very important part.

For many years it has been known that the pitch of some pure tones seems to change slightly as the intensity of the tone is changed, even though the impressed frequency remains constant. Dr. Stevens has made a more thorough investigation of the subjective quality of pitch and its relation to the objective

frequency and intensity of a tone. He has also found that three other subjective qualities, those of loudness, volume, and density, may be used to describe a pure tone, and the relation of these to frequency and intensity has been studied. To the layman, loudness and pitch mean definite things, but volume and density are less tangible. However, if we think of a high tone we realize that it seems "small" and "compact" as compared to a low tone. The idea of size corresponds to volume and "compactness" or "concentration" to density.

In studying these tonal qualities the apparatus shown in Figure 1 was set up to present to an observer, alternately, two tones differing slightly in frequency. All the apparatus was kept outside the sound-proof room in which the observer sat, with the exception of the speakers, calibrated microphone, and a rheostat which was used to control the intensity of one of the tones. This rheostat was adjusted by the observer until the two tones sounded equal in pitch, loudness, or any other quality which was being investigated. The intensity of the standard tone being known, that of the second tone was recorded and the pro-

FIGURE 1. Apparatus used for measuring tonal attributes. A TYPE 508 Oscillator was arranged with external condensers so that two frequencies differing by small known amounts could be obtained. These two frequencies were fed, alternately, to speakers near the observer's ears. The switching from one frequency to the other was done automatically at a rate of about 40 alternations per minute, and in such a manner that the tones were allowed to build up comparatively slowly so as to eliminate "clicking" in the speakers. A calibrated microphone, placed in the position normally occupied by the right ear of the observer, was used to obtain absolute values for the intensities used.

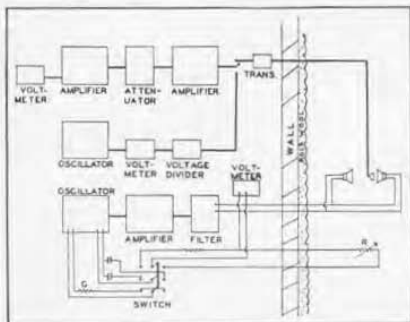

ess repeated. Several trials were made at various intensity levels, and different observers were also used.

By applying this procedure, isophonic contours are obtained which represent equal loudness, pitch, density, or volume. For example, in Figure 2 the percentage frequency change needed to keep the pitch constant is plotted against sound pressure, and a family of curves is obtained with the standard frequency as a parameter. If isophonic contours for the four subjective qualities (pitch, volume, density, and loudness) are plotted on one scale for a given frequency and intensity level, the changes in these tonal attributes caused by given changes in frequency and intensity can be compared very easily. This is done in Figure 3, which shows what change in the intensity of a tone must be made in order to compensate for a particular change in frequency, whenever it is desired to hold any one of the subjective aspects at a constant value. Dr. Stevens and his

colleagues have interpreted these results to mean various things regarding the physiology of the ear, and much of their work has been to correlate these results with the known facts regarding the process of hearing. Thus the partial tuning of the basilar membrane, the activation of the fibers in the auditory nerve, and similar phenomena are being studied in the light of the information provided by these experiments.

For some time it has been known that a sound stimulus generates an electric wave in the cochlea. Dr. Stevens showed that this effect is reversible. That is, he passed alternating current through the heads of several observers, and they then experienced an auditory sensation. One electrode was strapped to the arm and one was placed in a saline solution in the ear. Several sets of measurements were made in order to determine the amount of energy required at different frequencies to produce a threshold sensation of hearing and then to produce a sensation of shock. These threshold curves are very similar to the curves for normal hearing, as would be expected. At 500 cycles, for example, it takes but 10 decibels above 1 microwatt to produce a sense of hearing, while at 12,000 cycles it takes nearly 30 decibels. At about 125 cycles the two thresholds meet, and then the sensation of hearing by this electrical stimulation becomes rather strange, according to the reports of the observers. Pure tones were used in the measurements of the thresholds, but if

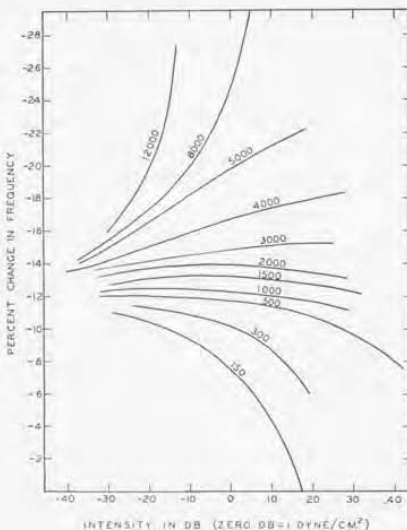

FIGURE 2. Contours showing the relation of pitch to intensity. The per cent change in frequency necessary to keep the pitch of a given tone constant in the face of a given change in intensity is a measure of the effect of intensity upon pitch. The vertical scale was so chosen that a contour with positive slope indicates that pitch increases with intensity. Note that pitch decreases with intensity below 2000 or 3000 cycles, then increases at higher frequencies.

very poor wave-forms such as the familiar saw-tooth discharge wave are used, the lower limit of frequency is extended indefinitely, although there is no longer the sensation of a continuous tone.

Unfortunately, the tones heard under electrical stimulation are greatly distorted and do not sound pure. This fact was demonstrated by sending the output of a radio receiver through the observers. Music and speech were recognizable as such but could not be understood with any degree of accuracy.

Several hypotheses have been advanced to explain the phenomenon of hearing by electrical stimulation, but the one which best fits the facts assumes that the same elements in the ear which produce an electric wave in response to mechanical vibration, also proceed to vibrate when subjected to an alternating electric field. It has been suggested that in this respect the hair cells of the inner ear behave in a manner analogous to tiny piezo crystals.

A most interesting investigation which is being carried on at the present time is the study of the distortion of pure tones produced by the ear. Harmonics so produced are heard subjectively, but are not easily measured or studied in the human ear. By the use of animals, however, Dr. Stevens and Dr. Davis have succeeded in obtaining much interesting information. It has been found that the cochlea of the ear produces an electrical potential which is very similar in form to the sound impressed on the ear, and that this potential is a very good index of the sound energy

FIGURE 3. Isophonic contours representing equal pitch, loudness, volume, and density of tones referred to a standard tone of 500 cycles and 60 db. Zero frequency = 500 cycles, and zero intensity = 60 db above the auditory threshold.

which reaches the end-organs of the auditory mechanism.

Tones are produced by a TYPE 713-B Beat-Frequency Oscillator the output of which is fed through an attenuator and then into a speaker box. From there, a rubber tube conducts the sound to the ear itself. The cochlear potential is picked up by a wick electrode from the round window. These potentials were then amplified and fed to a TYPE 636-A Wave Analyzer, an oscillograph, or a speaker. A calibrated microphone was also used to measure the absolute intensity levels at the ear.

When pure tones are used for the stimuli, an analysis of the electrical output shows that harmonics are introduced when the intensity of the stimulus reaches 40 or 50 decibels above the human threshold. At first the second appears; then, as the level is increased still further, the third, fourth, and even the fifth harmonics appear. As the harmonic content rises, the fundamental output tapers off and reaches a rather constant value by the time the stimulus has reached 100 decibels above the threshold.

One interesting fact is that after a level of about 90 decibels is reached the even harmonics begin to fall off, while the odd climb steadily.

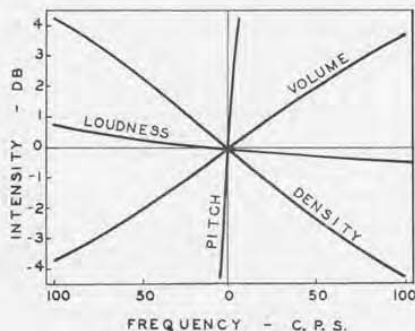

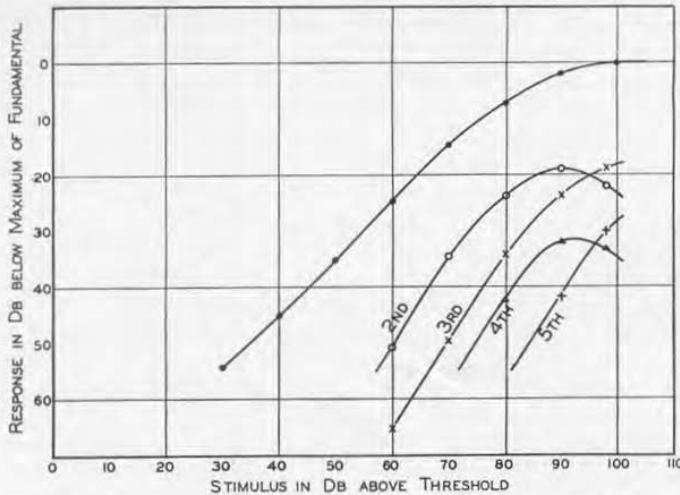

Analysis of the cochlear response of a guinea pig when stimulated by a pure tone of 1000 cycles.

These phenomena give rise to a hypothesis concerning the cause of the harmonics in the ear. With small impressed sound pressures the ear has a linear response, but, as the displacement of the ear mechanism increases, first one portion of the mechanism and then another reaches a limit beyond which Hooke's law does not apply and the "characteristic" curve of the ear is non-linear. If this curve were exactly symmetrical about the operating point, no even harmonics would be present. Since even harmonics were discovered, it is supposed that the constraining muscles of the middle ear impose unsymmetrical limits on the amplitude of vibration. This point was experimentally confirmed by changing the tension of the muscles of the middle ear and noticing that the amounts of even harmonics were correspondingly affected.

Some work was also done with combination tones. Two pure tones differing in frequency by several hundred cycles were introduced into the ear and the cochlear potential again analyzed. It

was then found that, in addition to the harmonics of both tones, many combination tones were present. In one instance a total of sixty-six combination tones were found in the output of a cat's ear. Three of these were of the seventh order, while ten were of the sixth order. One interesting thing occurred when two tones were impressed simultaneously: the harmonics of each were reduced appreciably below the level found when only one tone was used.

In addition to the investigations outlined in this article many more researches have been carried on in the past several years in this field. Furthermore, it is certain that more work will be done in the future to obtain information which will lead to an understanding of the nature of hearing. It is still fascinating to realize that the various branches of science can cooperate to produce instruments and techniques which will allow better results to be obtained than when each branch works in its own "back yard."

— MARTIN A. GILMAN

BIBLIOGRAPHY

- S. S. Stevens, "The Relation of Pitch to Intensity," *J.A.S.A.*, January, 1935.
 S. S. Stevens, "The Attributes of Tones," *Proc. Nat. Academy of Sciences*, July, 1934.
 S. S. Stevens, "On Hearing by Electrical Stimulation," *J.A.S.A.*, January, 1937.
 S. S. Stevens and H. Davis, "Psychophysiological Acoustics: Pitch and Loudness," *J.A.S.A.*, July, 1936.
 E. B. Newman, S. S. Stevens, and H. Davis, "Factors in the Production of Aural Harmonics and Combination Tones," *J.A.S.A.*, October, 1937.

TYPE 664-A THERMOCOUPLE— A HIGH-FREQUENCY VOLTAGE STANDARD



FIGURE 1. Front view of the TYPE 664-A Thermocouple showing the standard-voltage terminals. The circular plate mounts in the shield or on the panel of an r-f generator.

● ABOUT A YEAR AGO an experimental thermocouple and resistor combination for the standardization of high-frequency voltages was described in the *Experimenter*.^{*} Since that time, several requests have been received for similar devices, and, as a result, it has been decided to make a high-frequency thermovoltmeter element available as a stock item.

The previously described unit consisted of a thermocouple and a standard resistor in series, both using 0.4-mil nickel-alloy wire. The arrangement had

^{*}L. B. Arguimbau, "A High-Frequency Voltage Standard," *Experimenter*, June, 1937.

the serious drawback that only about one-half volt could be safely applied to the resistor unit. By using the heater of the thermocouple as the standard resistor, this disadvantage can be overcome. As will be pointed out later, the increased resistance does not introduce any error in the measurement.

One of the factors determining the high-frequency limit is the inductance of the heater, or, more precisely, the inductance-to-resistance ratio. This ratio can be reduced (1) by decreasing the wire diameter and (2) by increasing the resistivity of the material used (changing the length changes the inductance and the resistance but does not alter the ratio appreciably). A decrease in diameter lowers the power handling capacity,

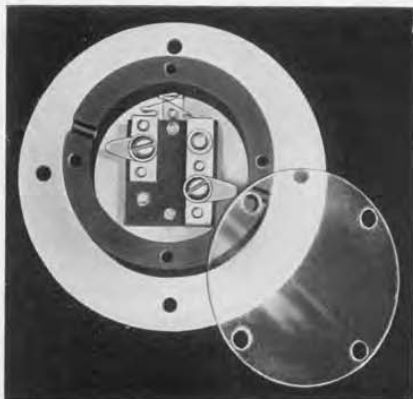

FIGURE 2. Rear view of the thermocouple.

so that an increase in the resistivity of the heater material is more desirable than the other method. After a numerical consideration of these various factors, a 3-mil carbon heater $\frac{1}{4}$ " long was chosen. The carbon heater has the disadvantage of having a bad temperature coefficient of resistance but, in addition to its other advantages, it is definitely non-magnetic whereas high-resistance alloys are not entirely free from suspicion in this respect.

The terminal and electrical arrangement, shown in Figure 3, has certain obvious advantages. When the couple is mounted in the case of a shielded generator, the input and output circuits have practically zero mutual reactance, avoiding stray induced output voltages. Since the voltage element is directly across the output terminals, the voltage sensitivity is independent of the resis-

tive or capacitive load and, in particular, of the capacitance between the output terminals. Applying Thevenin's theorem, this means that the effective output impedance is zero, an important practical advantage for high-frequency measurements.

The safe limit of output voltage is about 7 volts. At this voltage the heater resistance is approximately 200 ohms, and the couple output (through 10 ohms) is approximately 4 millivolts.

Since this standard is the best which we have found, no independent check on its accuracy is available. The computed error resulting from inductance is 1% at 700 Mc and 2% at 1000 Mc. Estimated bead capacitance gives an error of 1% at 10,000 Mc, and skin effect is 1% at 16,000 Mc.

—L. B. ARGUMENT

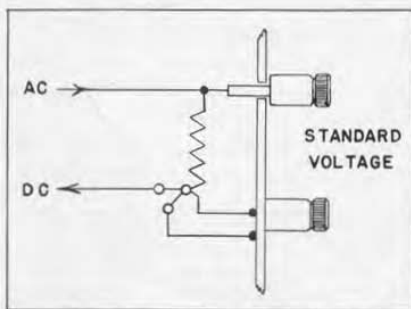

FIGURE 3a. Wiring diagram of the thermocouple.

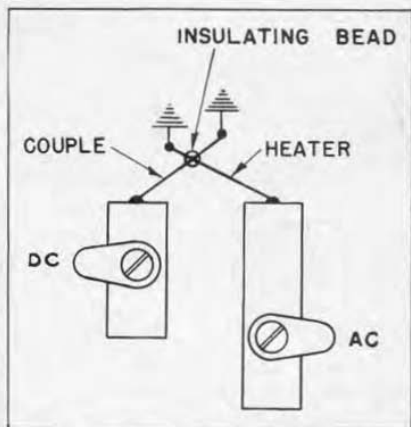

FIGURE 3b. Sketch showing the arrangement of the elements.

SPECIFICATIONS

Dimensions: Diameter of shield panel, 3 inches; diameter of case, 2 inches; depth behind panel, $\frac{3}{4}$ inch.

Net Weight: 7 ounces.
Code Word: FANCY.
Price: \$25.00.

GENERAL RADIO COMPANY

30 STATE STREET - CAMBRIDGE A, MASSACHUSETTS

BRANCH ENGINEERING OFFICES

90 WEST STREET, NEW YORK CITY

1000 NORTH SEWARD STREET, LOS ANGELES, CALIFORNIA

